

4
MUST-HAVE
TABLESAW JIGS

WOOD

Revealed:
Success
Secrets
For Painted
Projects
p.50

build this classic

chimney cupboard

p.44

*more
projects*

Chairside Magazine Rack
Keepsake Box • Turned Platter
Mission Mantel Clock

STEP UP to an 8" JOINTER



8 models
tested
and rated
p.69

see the new spiral cutterheads!



U.S.A. \$6.99

WOOD

February/March 2006, Issue 168

PROJECTS

- 44 country-classic chimney cupboard
- 54 four task-tackling tablesaw jigs
Improve the accuracy, versatility, and safety of your workshop's most important tool with a box-joint sled, a thin-strip ripper, and tenon-shoulder-cutting and cheek-cutting jigs.
- 60 tabletop treasure box
- 76 chairside magazine rack and table
Build the accommodating design at *right*, or opt for the totable magazine rack featured on *page 30*.
- 80 mission mantel clock
- 84 eye-pleasing turned platter
- 107 triple-treat photo frame

TECHNIQUES

- 14 troubleshooting jointer problems
- 32 two ways to enhance walnut's beauty
Discover the difference a filled-pore or multihued finish make on this favorite American hardwood.
- 50 painting secrets of a pro
Jeff Jewitt reveals his recipe for a rich antique look on poplar, pine, and aspen.
- 64 how to master hand-cut dovetails
- 96 routing finger joints
- 102 turn logs into choice turning blanks

TOOLS & MATERIALS

- 36 five shop-proven products
- 69 big-boy 8" jointers
See the advantages of stepping up from a 6" tool.
- 94 shop-tested: five glue-up gadgets

DEPARTMENTS

- 8 editor's angle
- 12 sounding board
- 18 shop tips
- 26 ask *WOOD*
- 116 what's ahead



This seal is your assurance that we build every project, verify every fact, and test every reviewed tool in our workshop to guarantee your success and complete satisfaction.



76



80



94



60



64



69



54

POWER IS NOW ON REBATE



Save up to \$200 on select JET products with JET Power Rebates!

Purchases must be made between September 1, 2005 and March 31, 2006 to qualify.

For more details, visit your nearest quality JET woodworking dealer or jettools.com.

JET

BUILT BETTER TO BUILD BETTER™

jettools.com

Better Homes and Gardens®

WOOD

February/March 2006

Vol. 23, No. 1

Issue No. 168

EDITOR-IN-CHIEF
BILL KRIER

Executive Editor **JIM HARROLD** Managing Editor **MARLEN KEMMET**

Editorial Manager, Tools and Techniques
DAVE CAMPBELL

Senior Design Editor **KEVIN BOYLE** Techniques Editor **BOB WILSON**

Projects Editor **OWEN DUVAL** Projects Editor **JAN SVEC**

Design Editor **JEFF MERTZ** Master Craftsman **CHUCK HEDLUND**

Art Director **KARL EHLERS** Associate Art Director **GREG SELLERS** Assistant Art Director **CHERYL A. CIBULA**

Production/Office Manager **MARGARET CLOSNER** Administrative Assistant **SHERYL MUNYON**

Photographers **MARTY BALDWIN, SCOTT LITTLE, BLAINE MOATS, JAY WILDE**

Illustrators **TIM CAHILL, LORNA JOHNSON, ROXANNE LeMOINE**

Technical Consultants **JEFF HALL, DEAN FIENE**

Contributing Craftsman **JIM HEAVEY**

Proofreaders **BARBARA KLEIN, IRA LACHER, JIM SANDERS**

CUSTOMER SERVICE: 800/374-9663

For more ways to reach us about specific matters, see page 12.

Senior Vice President/Publishing Director **DOUG OLSON**

Publisher **MARK HAGEN**

ADVERTISING

CHICAGO OFFICE: 333 N. Michigan Ave., Suite 1500, Chicago, IL 60601

Phone: 312/580-7956 Fax: 312/580-7906

Account Executive **JACK A. CHRISTIANSEN**

Direct Response Manager **CAROLYN DAKIS**

Direct Response Sales Representative **SANDY ROBINSON**

Marketing Manager **AMANDA SALHOOT**

Sales and Marketing Assistant **GAYLE CHEJN**

Sales and Marketing Assistant **JENNIFER RUGGIERI**

DETROIT: RPM Associates

29350 Southfield Rd., Suite 31, Southfield, MI 48076

Phone: 248/557-7490 Fax: 248/557-7499

ATLANTA: Navigate Media

1875 Old Alabama Rd., Suite 1320, Roswell, GA 30076

Phone: 678/507-0110 Fax: 678/507-0118

Business Manager **JOEL ETIENNE**

Consumer Marketing Director **ROBIN HUTCHINSON**

Assistant Consumer Marketing Manager **BILL WOOD**

Associate Director of Marketing-Newsstand **TOM DEERING**

Production Manager **STEVE KRIDER**

Advertising Operations Manager **LIBBY EHMKE**

MEREDITH PUBLISHING GROUP

President **JACK GRIFFIN**

General Manager **TOM HARTY**

Finance & Administration **KARLA JEFFRIES**

Consumer Marketing **DAVID BALL**

Manufacturing **BRUCE HESTON**

Creative Services **ELLEN DE LATHOUDER**

Interactive Media **LAUREN WIENER**

Corporate Sales **JACK BAMBERGER**

Group Marketing **NANCY WEBER**

Director, Corporate Sales **DORENE BAIR**

Executive Director, Corporate Research **BRITTA C. WARE**

Meredith
CORPORATION

Chairman and Chief Executive Officer **WILLIAM T. KERR**

President and Chief Operating Officer **STEPHEN M. LACY**

In Memoriam — E.T. Meredith III (1933-2003)

© Copyright Meredith Corporation 2006. All rights reserved. Printed in the U.S.A.



Owen built this bed from plans in issue 144 for his son David.



Dave made three of this dice game for holiday presents.



New carvers, Cheryl and Sheryl, each made a grape vine plaque from basswood.



The Toughest Glue On Planet Earth.™



Bonds hundreds of materials including wood, stone, metal, ceramic & more! Incredibly strong & 100% waterproof!

Circle No. 50

1-800-966-3458 • www.gorillaglu.com

The Toughest Tape On Planet Earth.™



Extra Thick. Extra Stick.
New Gorilla Tape sticks to things ordinary tapes simply can't.

1-800-966-3458 • www.gorillatape.com

editor's angle

It takes a spine to stand up to the mailman

By now you've no doubt noticed something different about this copy of *WOOD*® magazine. It has a "spine"—a printer's term describing the place where pages are glued (not stapled) together. I'd like to tell you why we've made this significant improvement.

After binding together *WOOD* magazine with staples for the past 167 issues, we've switched to gluing the pages together. Why invest in this more-expensive process now? There are two key reasons that benefit you:

- 1.** We like our customers to be 100 percent satisfied with the magazine. So it really bothered us to hear from a few of you that your copy of *WOOD* arrived in the mail with a torn or missing cover. We looked into what was causing this problem and discovered that today's highly automated mail-sorting equipment can tear away pages from "saddle-stitched" (stapled) magazines. It turns out that the best way to build a tougher magazine is to "perfect-bind" (glue) it together. We're confident that doing this will dramatically reduce the number of magazines that arrive damaged.
- 2.** We also know that the vast majority of you save your copies of *WOOD* magazine for many years, accessing past articles as you need them. The new flat spine gives us a place to print the issue month and number, as well as list some major articles. That should make it easier for you to retrieve the right issue from your collection.

About the protective cover

For this first perfect-bound issue we teamed with the folks from Varathane to provide an extra margin of protection: a sponsored "cover wrap." You can leave it in place or

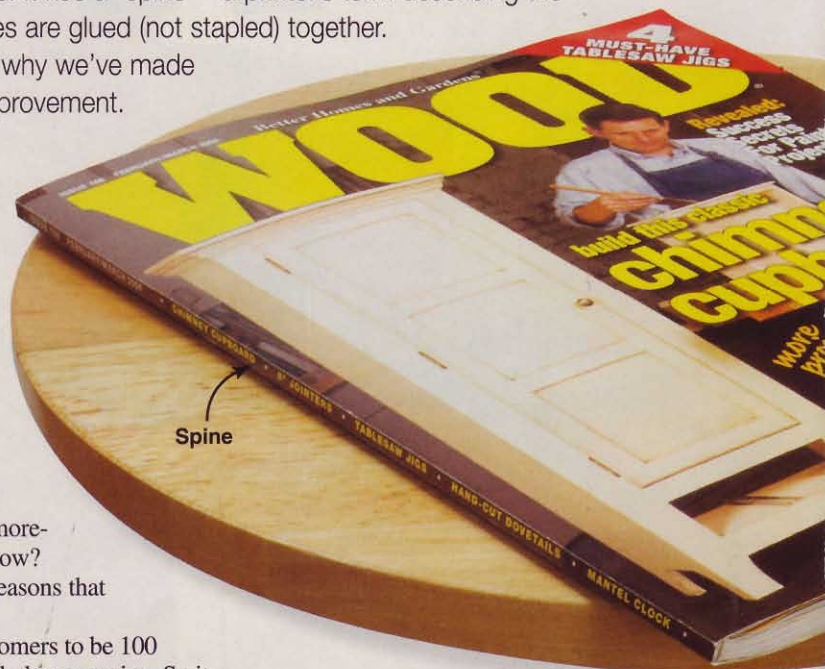

simply peel it away without damaging the magazine underneath. A special releasable glue makes this possible.

You'll also notice that the pattern insert on pages 89-92 has changed slightly. It's the same size, but glued into place along one edge. To remove it, simply cut along the dotted line.



I hope these changes meet with your approval. Of course, your input on this, or any other aspect of the magazine, is always welcome. Simply e-mail me at bill.krier@meredith.com or send your comments via regular mail to my attention at the editorial feedback address on page 12.

Best wishes for a happy and healthy New Year in 2006.

Bill Krier



sounding board

Our bulletin board for letters, comments, and timely updates

Stay safe when working around jointer knives

In the October 2005 issue, your article on adjusting jointer knives had me worried. For many years I have worked for the schools in Washington state setting up jointer and planer blades. When I started, I had injured myself a few times when the wrench slipped, causing my fingers and hand to encounter the sharp knives. To prevent this from happening, I learned to place a thin piece of plywood over the cutterhead for protection. I also use a mallet to gently tap the wrench for the final tightening of the gib bolts, as shown at right.

—Lewis Helgren, Tacoma, Wash.



Dogs find Gorilla tasty

My husband is a vet, and he wanted me to tell *WOOD*® magazine editors [and readers] that dogs like to eat Gorilla Glue. A vet journal he subscribes to [*Veterinary Practice News*] recently cited six cases where dogs ingested the glue. It causes a gastrointestinal blockage when it hardens into a loaf-like mass that must be surgically removed.

—Betsy Freese, Des Moines, Iowa

Note that the bottle label on Gorilla Glue says "Warning: Keep out of reach of Children and Animals." This pertains to other polyurethane glues too.

—Jim Harrold, Executive Editor



Selling magazine projects

I make simple M&M candy dispensers. Recently, a friend asked me for a giraffe dispenser, and I told her I'd look for a pattern. Then—what luck—I saw your kid's giraffe bank in the October 2004 issue.

I used your how-to instructions with two changes. First, I glue-joined an extra 3/4"-thick body part to create a 1 1/2"-wide body and larger cavity for holding candy. And, with my router, I enlarged the slot in the mouth and neck to 1" deep. Now, to

dispense candy, I simply tip the giraffe forward, and pieces drop out. When I delivered the critter to my friend's office, she and her coworkers went wild.

Could you please tell me what to do and whom to contact for permission to modify the pattern and sell giraffe candy dispensers?

—Bill Switzer, Salt Lake City, Utah

Bill, most of the projects are designed by our editorial staff; a few, purchased from outside craftsmen. To find out if a project is staff designed, check the names at the end of the article and compare those names with the staff list on page 6.

For staff-designed projects, you can make as many as you like for yourself or as

personal gifts. But we put a limit of 25 on these projects if you intend to sell them. This prevents the mass manufacture of our copyrighted projects. Projects designed by non-staff designers can be built only for yourself or as gifts for others. You cannot sell those projects.

—Marlen Kemmet, Managing Editor

Big and tall workbench

I just wanted to thank you for mentioning to extend the legs for the low-dough workbench in *WOOD* magazine issue 163. Being 6' 4", I find most benches too low and, after working at one for long periods, a pain in the back.

Wayne VanDerVeen, Hawthorne, N.J.

HOW TO REACH US

■ Woodworking advice:

Post your woodworking questions (joinery, finishing, tools, turning, general woodworking, etc.) on one of 20+ online forums at woodmagazine.com/forums.

■ Editorial feedback:

Send your comments via e-mail to woodmail@woodmagazine.com; or call 800/374-9663 and press option 2; or write to *WOOD* magazine, 1716 Locust St., LS-221, Des Moines, IA 50309-3023.

■ Subscription assistance:

To notify us of an address change, or to get help with your subscription, go to woodmagazine.com/service; or call 800/374-9663 and press option 1. Outside the U.S., call 515/247-2981. Or write to *WOOD* magazine, P.O. Box 37439, Boone, IA 50037-0439. Please enclose your address label from a recent issue.

To find past articles:

See our index at woodmagazine.com/index.

■ Past issues and articles:

Order past issues of *WOOD* magazine, our special issues, or downloadable articles from issue 100 to present. Visit our online store at woodmagazine.com/store or call 888/636-4478. Some issues are sold out.

■ Updates to previously published articles:

For an up-to-date listing of changes in dimensions and buying-guide sources from issue 1 through today, go to woodmagazine.com/editorial.

troubleshooting jointers—easy as 1, 2, 3, 4

A jointer needs only a few adjustments to produce perfectly flat cuts and surfaces square to each other. But each one is critical. Here's how to detect and correct the most common problems.



Check for parallel alignment by raising the tables to full height and laying a straightedge across them. Light showing beneath indicates a need for adjustment.

Problem 1: CONCAVE CUTS

The boards that you run through your jointer end up shallower in the center than at the ends.



CAUSE. Either one or both ends of your jointer table sag some.

SOLUTION. Although the infeed and outfeed tables aren't on the same plane during use, they still must be absolutely parallel with each other along their total length. To check for and correct this malady, first unplug the machine, and then slide the fence completely off the tables. Next, remove the cutterhead guard and raise the infeed table to the same height as the outfeed table. Now, lay a metal level or straightedge across the length of both tables, as shown in the photo above, right. If you see any light under the straightedge at the outer end of either table, it's sagging. Correct this by tightening the upper gib screw, as identified below, until you can't see any light. That should do it. Replace the cutterhead guard and fence.

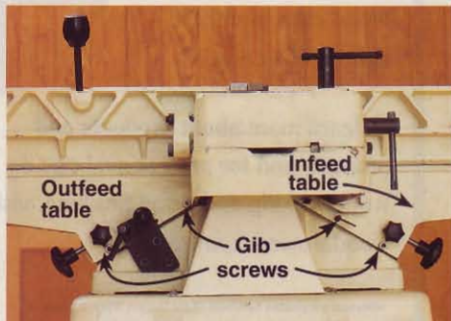

Gib screws are the key to adjusting the infeed and outfeed tables to get them parallel, and you may have to adjust all of them in sequence. Check the owner's manual for your jointer to locate them and determine their adjustment order.

Problem 2: CONVEX CUTS

Your jointed edges prove slightly narrower at the ends than at the center.



CAUSE. The exact reverse of Problem 1—the table is high on one or both ends.

SOLUTION. Check for this in the same manner outlined above, except look for light under the middle of the straightedge near the cutterhead. To lower the guilty table or tables, loosen the gib screw until the problem is corrected.

Note: For an even more accurate check of table alignment, use a pair of 12" triangles, as shown below. Place one triangle on each table with the 90° edges of the triangles touching. A gap at the top means one or both tables are sagging at their outer ends. A gap at the bottom indicates that one or both tables are too high at their ends. This method won't point out the guilty table, but you can quickly find out by tightening or loosening the gib screws on the infeed table. If that doesn't work, adjust the outfeed table using its gib screws.

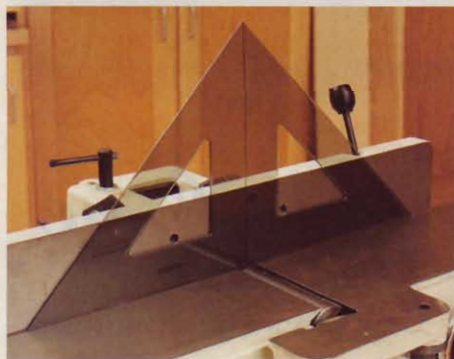

In checking for parallel alignment with this method, use a pair of 12" drafting triangles. There should be no gaps at top or bottom where they meet.

Problem 3: OUT OF SQUARE

After jointing, the face and edge of a workpiece don't meet at an exact 90° corner.

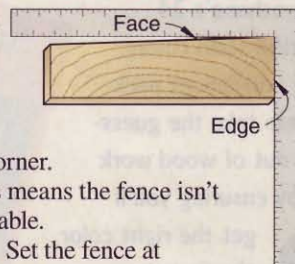

CAUSE. This means the fence isn't set 90° to the table.

SOLUTION. Set the fence at exactly 90° before each jointing session. Position a drafting triangle as depicted below, and loosen the fence's bevel lock. Next, move the fence until there are no gaps between the triangle and the table or fence, and then retighten the lock. (Use the same technique to set the 45° angle when needed, or angles between 45° and 90°.)



Use a triangle to check if the fence is square to the table. A gap tells you it isn't.

Problem 4: SNIPE

Jointed boards that show a small, hollow cut at their ends suffer from "snipe."



CAUSE. This happens when the outfeed table no longer supports the workpiece after it passes the cutterhead. (The knives also may be set too high, but check out the table height first.)

SOLUTION. Correct poor alignment by raising the outfeed table this way: First, lower the outfeed table slightly, and then set the infeed table for a light cut. Next, slowly feed a piece of stock across the cutterhead until the cut edge projects over the outfeed table about 1", and then shut off the jointer, as shown below. Now unlock the outfeed table; raise it until it just touches the workpiece, and then lock it down. Now, turn on the jointer and finish jointing the edge, stopping to check if the outfeed table fully supports the cut. ♣

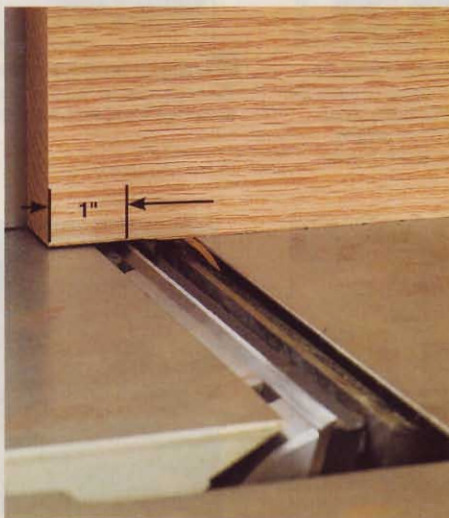

To eliminate snipe, lower the outfeed table slightly, joint a piece of stock about 1" in from the end, and then shut off the machine. Raise the outfeed table until it touches the cut stock, and then finish the cut.

Help for adjusting cutterhead knives

If the knives of your jointer are out of alignment, you may need to adjust them. You'll find this procedure described in full on pages 36-37 of issue 165, October 2005. Use the same procedure when replacing knives.

Written by **Pete Stephano**
Illustrations **Roxanne LeMoine**

LOWEST PRICES UNBEATABLE QUALITY



**WORKHORSE
ROUTER TABLES**

**MUSTANG
Router Table**

**DON'T SETTLE FOR
SECOND BEST!**

Vertical and Horizontal Routing In One Table!

- Portable design for ease of use
- Quiet deluxe cabinet base
- Laminated 12 ply birch
- 1-3/16" ultra flat top
- Deluxe fence system
- Fits all routers with up to 3-1/2" diam. bits

**ONLY
\$215**

REG \$295 - WL-TAB1



PRO CABINETMAKER

6pc Door Set

- 1/2" Shank Router Bits
- 2-pc Rail & Stile (Roman Ogee)
- Drawer Lock
- 3 1/4" D Panel Raiser (Ogee) with UnderCutter
- Door Lip
- Reversible Glue Joint



ONLY

\$119 set

\$175 VALUE

WL-2020-1

800-472-6950

ORDER 24/7

WOODLINE.COM

FREE STRAP CLAMP

8 Piece PICTURE FRAME SET

Perfect for making great looking picture frames. Bits can be combined to form complex mouldings or simple decorative frames.

**OUR PRICE ONLY
\$75 set**
WL-2008
\$189 VALUE

CARBIDE

66 Piece Master Woodworking Router Bit Collection

This may not be every bit you'll ever need, but it's close! Use this set to complete your collection!

WL 2066 1/2" Shank..... **\$189**

WL 2065 1/4" Shank..... **\$189**

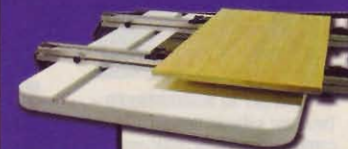

PROGRIP
YOUR PARTNER IN WOODWORKING

- Reliable cam-action system for variable pressure levels
- Double T-slot system for limitless accessory jig applications
- Unique Back-To-Back system that can be separated into 2 individual clamps for unbelievable versatility in all projects

Ask About Our 90 degree Heads for TRU-GRIP Clamps and PROGRIP Clamps

24" ProGrip Bar Clamp.....	\$22.95
36" ProGrip Bar Clamp.....	\$24.95
50" ProGrip Bar Clamp.....	\$28.95
36" ProGrip Back-To-Back Bar Clamp.....	\$40.95
50" ProGrip Back-To-Back Bar Clamp...	\$49.95

SOLID ALUMINUM Advanced Aluminum Multi-Channel Extrusion Body Provides Unmatched Rock-Solid Stability and Long-Term Reliability

The BEST Bar Clamps At The BEST Prices!

Circle No. 1369

FREE CATALOG 1-800-472-6950

WOODLINE USA
111 Wheeler St, LaVergne TN, 37086

shop tips

Helping you work faster, smarter, and safer

Our Winner

Spare stock storage? Hang it all!

I'm an avid woodworker operating in a space-challenged basement shop. Material storage continually has been a problem, especially for long boards. I've tried many different storage systems, but the boards I want always seem to get buried. Out of necessity, I came up with the storage system shown here. Besides offering equal access to all stored boards, the racks function like stickers by allowing air to circulate equally around the boards so they acclimate to my shop.

To make a set of racks, cut 8"-wide parts from $\frac{3}{4}$ " plywood. To store $\frac{3}{4}$ "-thick stock, drill a series of 1" holes, with centers 2" apart. For thicker boards, reserve some space for $\frac{1}{2}$ "-diameter holes, centered 3" apart. (As shown, a 48" long rack will hold sixteen $\frac{3}{4}$ " boards and three $\frac{6}{4}$ " boards.)

Lay out the slots of the rack by extending two 20° lines out from each hole with a sliding bevel, and then cut out the slots with a bandsaw or jigsaw. For wall mounting, add a $\frac{1}{2}$ " cleat alongside each rack, and then cut out the slots with

a bandsaw or jigsaw. For wall mounting, add a $\frac{1}{2}$ " cleat alongside each rack, and then cut out the slots with a bandsaw or jigsaw. For wall mounting, add a $\frac{1}{2}$ " cleat alongside each rack, and then cut out the slots with a bandsaw or jigsaw.

—Larry Courtois,
Imperial, Mo.



Photo: Greg Smith, Garden Studio

You might say that working with wood runs in Larry Courtois' family. He, his father, brother, and eldest son all chose carpentry for a career. About eight years ago, our Top Shop Tip winner, shown above, took up furnituremaking in his spare time, and now spends as many hours a week in his basement shop as he does on the jobsite as a construction supervisor.

Larry Courtois' reward for sending the Top Shop Tip, at left, is this DeWalt DW718 12" sliding compound miter saw. Nice work, Larry!



Top tips win tools!

Describe how you've solved a workshop puzzler, and you'll earn \$75 if it appears here. And, if your tip garners Top Shop Tip honors, you'll also win a tool prize worth at least \$250.

Send your best tips, along with photos or illustrations and your daytime phone number, to: **Shop Tips, WOOD Magazine, 1716 Locust St., LS-221, Des Moines, IA 50309-3023.** Or e-mail tips to: shoptips@woodmagazine.com. Remember to include your contact info in the e-mail as well.

Because we try to publish original tips, please send your tips only to WOOD® magazine. Sorry, submitted materials can't be returned.

top shop tip

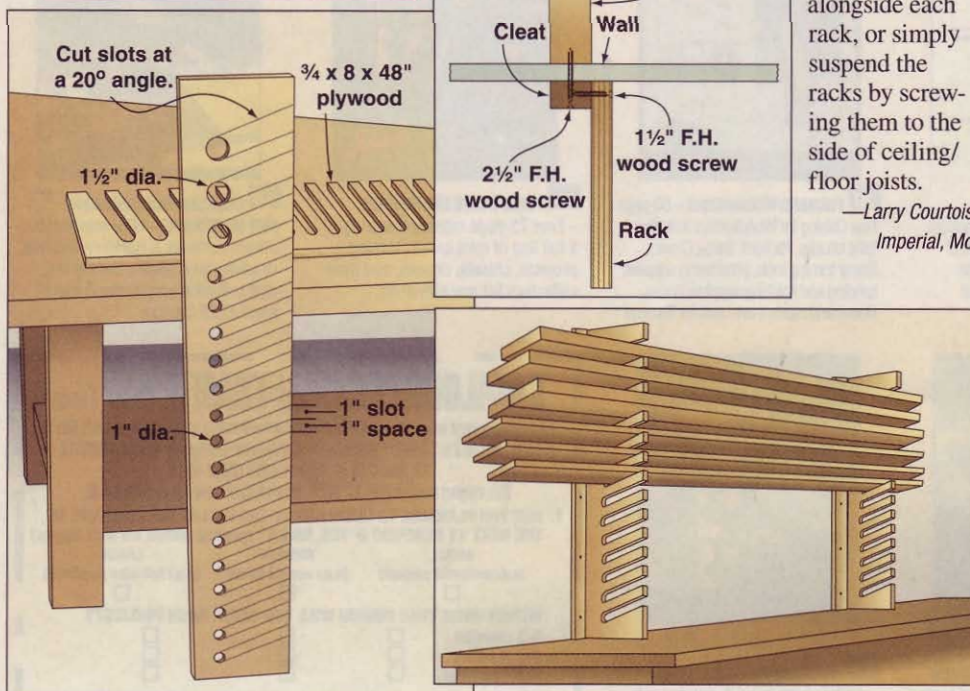

From speed square to fast fence

My bandsaw did not come with a rip fence, so I needed a simple solution. Watching carpenters use a speed square as a cutting guide gave me an idea. I simply clamp the square to the table with its flange along the front edge for a handy, reliable fence that I can pop on and off as needed.

A speed square costs only a few dollars, and its thick base makes it easy to square it to the table. Also, its $\frac{1}{4}$ "-thick body provides enough edge to act perfectly as a guide for most ripping tasks.

—Adeline Koebel, Manitowoc, Wis.

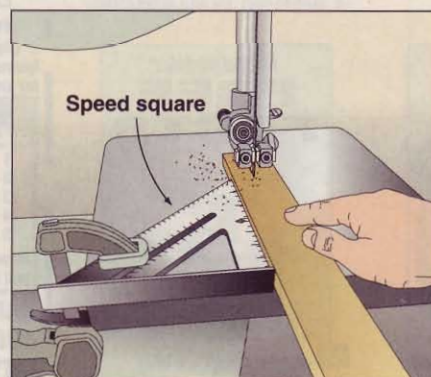

continued on page 20

Lift-assist help for tilt-top router tables

My router table top attaches to its cabinet with a hinge, which makes it very convenient when I want to change or adjust the height of a bit. Unfortunately, the top is heavy and occasionally slams down. Not only are these sudden falls hard on the router, fingers that happen to be in the way don't fare very well either. To prevent these sudden freefalls, I installed a pneumatic storm-door closer to act as a lift-assist device.

Install the closer by first attaching its brackets and pulling out the rod to its maximum distance. (Use the rod's "hold-open" clip to keep it extended.) Position the closer brackets far enough forward so they can bear the weight of the top and high enough that the top can open to the desired distance. Screw the brackets to the cabinet and top, and set the pressure-adjustment screw on the back of the piston housing so the top closes at the desired speed.

With the closer in place, you can use the "hold-open" clip to keep the top up while you adjust the router. Most hardware stores carry door closers as replacement parts, or you may be able to salvage one when you or a neighbor replaces a storm door.

—Yaniv Matza, Tamarac, Fla.

continued on page 22

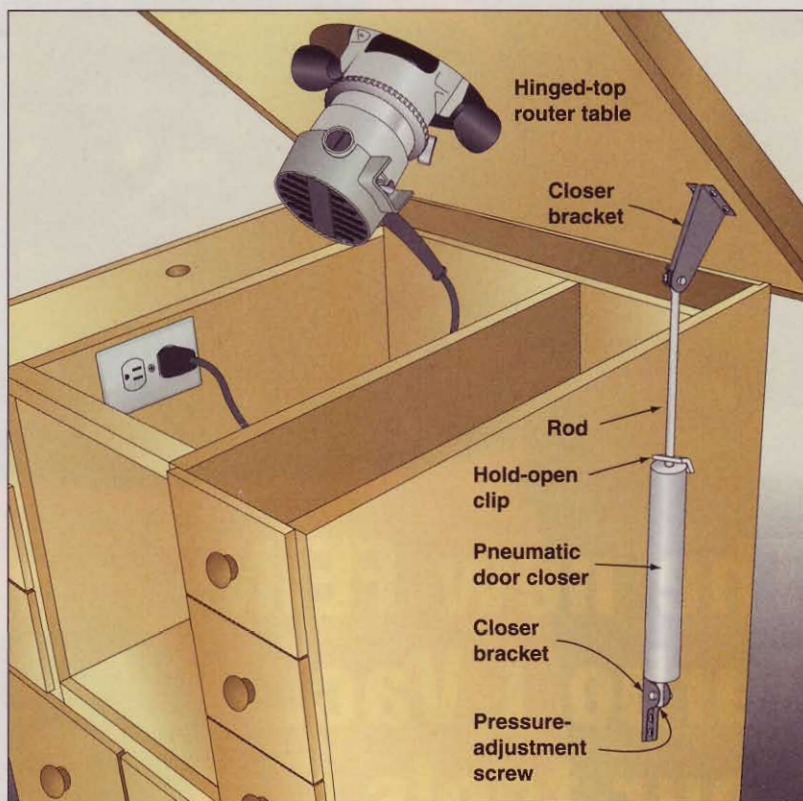

STOCK & CUSTOM WOOD TURNINGS

Red Oak
Soft Maple
Cherry
Black Walnut
Red Birch
Hard Maple
Alder
Hickory
Pine
Mahogany

10 Wood Types

OSBORNE
Wood Products, Inc.

www.osbornewood.com

Call for a catalog: 1-800-746-3233 • Order line: 1-800-849-8876
8116 Highway 123 North • Toccoa, GA 30577 • Email: turn@alltel.net

Circle No. 1849

Original Saw
3512-01

Improved

- 24" Crosscut
- Dado operations
- bevel cutting
- miter cutting
- compound mitering
- 1 & 3 phase models
- Consistent results day after day.
- Year after year
- It all adds up.....
- See website for details

ripping Bevel cutting

ORIGINAL
Saw Company

800/733-4063
www.originalsaw.com

Original Saw Company - Britt, IA 50423

Our 15th year
1990 - 2005

Circle No. 1619

Thrifty, nifty technique for enclosing shop ceilings

I have a basement shop that had an unfinished ceiling, where the exposed wires and plumbing were always collecting dust. I wanted to put in a ceiling, but I had three problems—low ceiling height, the need to maintain access to plumbing and electrical, and not a lot of extra money.

I began by ripping 1"-wide nailing cleats from scrap lumber and attaching them inside and flush with the bottom edges of the ceiling joists. Then I cut drywall to lie in the space between the joists and dropped the pieces in place on top of the cleats.

To minimize cost, you can often find free drywall scraps at construction sites or low-cost damaged pieces at the lumberyard. At the same lumberyard, look for some mismixed high-quality paint that can be had for a song.

—Robert King, Washington, Kan.

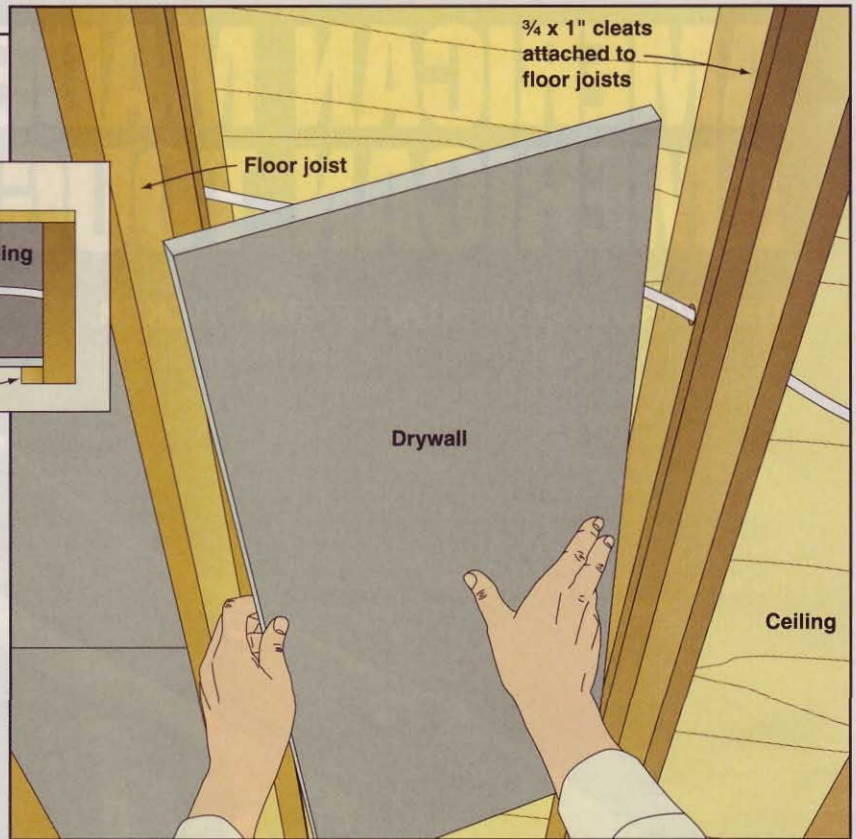
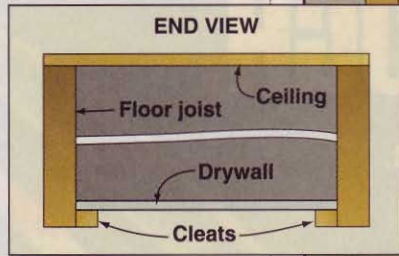

Circle No. 1792

YORKCRAFT®

The perfect union of quality with low price!

YC-6J 6" Jointer
with 1 hp 1 ph motor and 3-knife cutterhead
\$339⁰⁰

FEATURES: Center-mount fence with rack and pinion adjustment. Fence tilts both directions to 45°. Jackscrew knife adjustment. Enclosed stand with built-in wheels for mobility. Rabbeting table and ledge. Dust hood.

BUILT-IN WHEELS FOR MOBILITY

YC-8J 8" Jointer
with 2 hp 1 ph motor and 4-knife cutterhead
\$649⁰⁰

BUILT-IN WHEELS FOR MOBILITY

The YC-8J features an extra long 72" table

New!
The YC-8J Jointer now comes with a 2 hp 1 ph motor and 4-knife cutterhead... same low price.

YC-15P 15" Planer
with 3 hp 1 ph motor and 3-knife cutterhead
\$799⁰⁰

BUILT-IN WHEELS FOR MOBILITY

FEATURES: Table height adjustable. Jack screw knife adjustment. Two feed speeds. Dust hood. Solid, cast iron table extensions. Enclosed stand with built-in wheels for mobility.

YC-20P 20" Planer
with 5 hp 1 ph motor and 4-knife cutterhead
\$1,299⁰⁰



Prices: FOB, York, PA. Subject to change without notice

WILKE
MACHINERY COMPANY
MACHINERY POWER TOOLS

For information and a **FREE** catalog
1-866-764-7934
www.wilkemach.com
write or visit our showroom:
3230 N Susquehanna Trail, York, PA 17402-9716

ask wood

Answers to your questions from letters, e-mails, and WOOD Online®

Circ saw blades don't stack up well

Q: Is it safe to use 7¼" circular-saw blades stacked together for making dados on a tablesaw? Each blade is about ⅛" thick. I get tiny ridges, but clean them up with a chisel. Also, I have a wobble dado blade that I can use on either my tablesaw with a guard on or on my radial-arm saw without a guard. Which is safer?

—Les Willoughby, West Valley, Utah

A: You can use stacked circular-saw blades to cut dados on a tablesaw, Les, as we confirmed in the *WOOD*® magazine shop, but your dado cut quality will suffer. To make circular-saw blades cut even rough dados, you'll need blades of the same brand and model to avoid minor differences in diameter. We checked two brands of blades and both had teeth between ⅛" and ⅜" wide, not ⅛". So three new blades costing about \$10 apiece would only make a dado less than ¼" wide, as shown *below*. That's with two cardboard spacers on both sides of the center blade.

Stack enough blades to make a ¾" dado and you've spent more than the price of a

Freud SD206 6" dado set that will produce flat-bottom cuts with greater adjustability and better chip removal. By cutting cleaner, a dado set lets you eliminate the cleanup stage using your chisels.

Circular-saw blades leave uneven dado bottoms, as shown *below right*, because the teeth on many types have alternating top bevels for faster cutting, as illustrated *below*. By comparison, the tops of dado-blade teeth are ground to produce flat-bottom cuts.

As for that wobble dado, Les, we've never been a fan of these either on a tablesaw or radial-arm saw. Stacked dados produce cleaner cuts and work quieter than wobbles.

Whatever your choice, safety dictates that you use your tablesaw unless you're able to fit your radial-arm saw with a dado-blade guard. Two other reasons to use a tablesaw: You're protected from most of the blade and you can use both hands to control the speed of your cut.

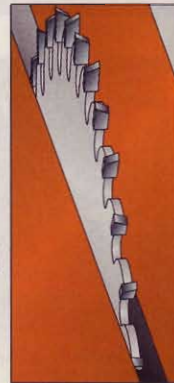

Alternating top bevel teeth

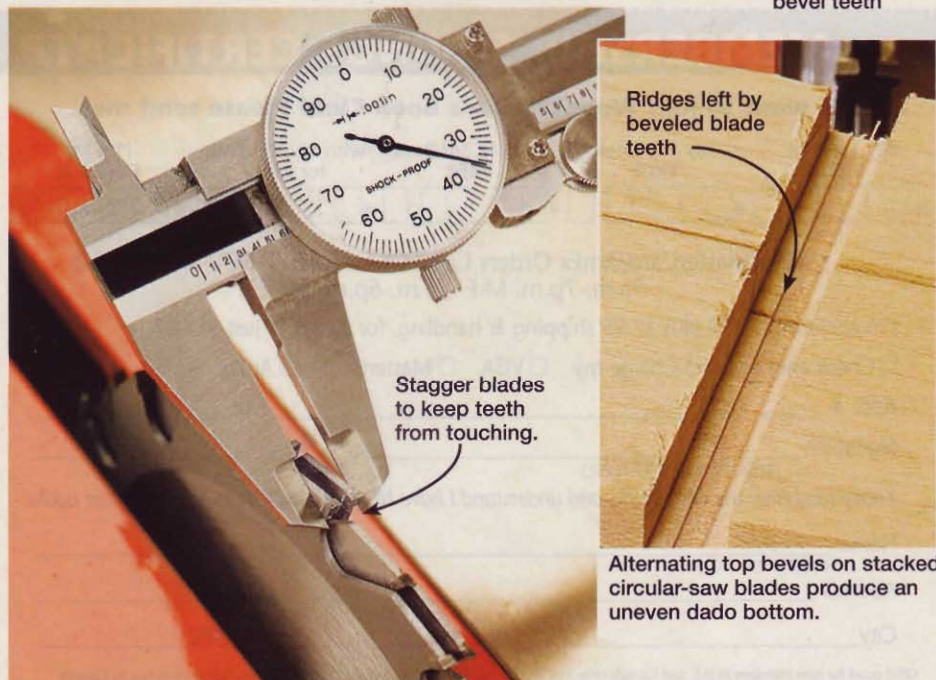

Our three 16-tooth, 7¼" circular-saw blades have two cardboard spacers between each blade, producing roughly a 15/64" dado because the ⅜"-wide teeth overlap.

Clearing the air

Q: On my pneumatic tools, I installed an air dryer to remove moisture and fine particles. I use the type for paint guns all of the time with every air tool. My buddies tell me that nobody uses them on air nailers, but I have never had a tool break due to moisture. Am I doing right by drying my air?

—Bob Davis, Denison, Texas

A: Air dryers or moisture filters make sense for spray guns, Bob, but they're more of a precaution than a necessity for nailers. Senco Products, for example, suggests attaching moisture filters to compressors powering its nailers, but doesn't require them. Just make certain your moisture filter doesn't restrict air flow to your nailer.

Moisture condenses in an air compressor tank and air hose during use. If you use your nailer infrequently in high humidity, then store it for long periods, condensation from the compressor can interfere with lubricant in the tool or damage some rubber seals and diaphragms by causing them to swell, warns Senco technical support manager Lee Zinsle.

To protect your tools, drain moisture from the compressor tank twice daily during heavy use. Before storage, lubricate nailers as the manufacturer recommends.



continued on page 28

Make a stable table

Q: I wanted a solid wood top for a small pub table. I used narrow oak boards that measured 8 percent moisture content and were acclimated to my shop. I glued and biscuit-joined the edges, and alternated the end-grain rings on adjacent boards. I then glued and screwed a 3/4" plywood backer to the solid oak top to keep it flat and stable. Within two days after I stained it with water-based stain, the

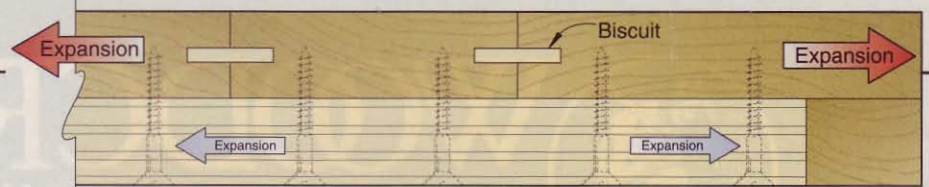

Plywood produces minimal expansion, as shown by the blue arrows, compared with solid lumber's considerable expansion across the grain, indicated by the red arrows.

oak and plywood top had cupped a good 1/4".

—Wayne Oldenburg, Roscoe, Ill.

A: Bonding plywood to solid stock was this top's undoing, Wayne. That's because solid wood and plywood expand and contract at different rates with changes in moisture content, as illustrated above.

Sometimes, simple is better when it comes to glue-ups. Limit boards in your top to no more than 5" wide, and then plane stock to the thickness you want. Edge-glue the pieces and allow the glue to dry thoroughly before sanding the top.

Instead of using plywood to stabilize the top, attach it to the apron using fasteners that accommodate expansion, such as a figure-eight connector.

Oil-based stain will introduce less moisture to the wood, but you may still be able to use water-based stain if it's removed promptly and not allowed to pool on the surface. Should the wood warp after staining, allow several days for the wood to dry again before proceeding.

How to compensate for undersize dowels

Q: I found some 3/8" dowel stock that turned out to be as much as 1/64" undersize. How much clearance will glue fill? How loose is too loose?

—Robert Vawter, Spokane, Wash.

A: Water-based wood glues make poor gap fillers, Robert, because they can leave tiny voids as the water in them evaporates. Proper fit means the dowel can be inserted with finger pressure or a light tap, according to Dale Zimmerman, technical specialist for Franklin International, makers of the Titebond line of glues. The dowel should not fall out of the hole if the joint is turned upside down. Where undersize dowels make gaps unavoidable, use epoxy glue that doesn't leave voids as it cures. Drilling a smaller diameter hole may also solve your problem.



The First to FINISH WINS!

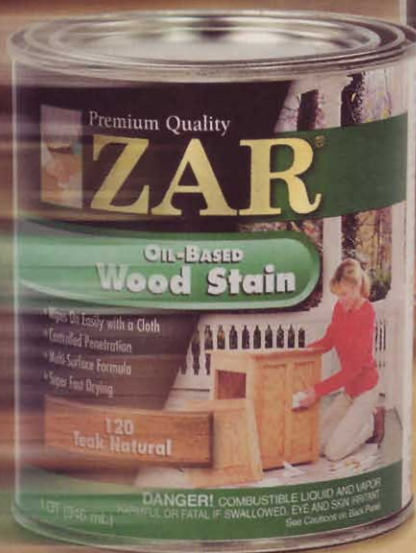

SUPER-FAST DRYING FORMULAS

If you want a quality finish and you want it fast, the name to look for is ZAR®.

ZAR Premium Quality Oil-Based Wood Stain provides rich uniform color in just **3-hours**. This new fast-drying formula is available in 20 popular colors and a tint-base for custom colors.

ZAR ULTRA Fast Drying Polyurethane is an oil-based polyurethane which provides a beautiful

protective finish that will last in the toughest conditions. It dries and can be recoated in just **2-hours**. Available in gloss, semi-gloss, satin and antique flat sheens for the look you want.

ZAR Wood Stain and Clear Finishes, the perfect choice for the fastest finish — Making you the winner.

ZAR® The fastest way to a beautiful finish!
For a free brochure and dealer nearest you, call
1-800-272-3235 or visit www.ugl.com

Circle No. 141

Benchtop tablesaws can handle dados

Q: I recently purchased a Bosch 4000 benchtop tablesaw and wanted to buy a dado blade for it. When I went into a woodworking store to purchase one, the store owner said that a dado blade was unsafe for a benchtop tablesaw. He said the saw isn't heavy enough. Do you agree with his warning?

—Tony Brantzeg, Downington, Pa.

A: Unless you're cutting something extremely heavy or unwieldy, Tony, the 4000 should be able to handle most dado chores using an 8" blade set. We were able to mount a 7/8" dado in the 4000 we recently tested. For added capacity, mount the narrower of the two washers nearest the motor, advises Michael Williams, Bosch benchtop tools product manager. Using a shop-made zero-clearance insert, we managed a maximum blade height of 2 1/8". Bosch's dado set accessory (part #TS1007), which includes a table insert and instructions, cuts a maximum 1 3/16" dado up to 2 1/8" deep. For added stability while making cuts—including dados in long boards or full panels on any portable saw—enlist a helper or use outfeed supports to control workpieces.



Got a question?

If you're looking for an answer to a woodworking question, write to **ASK WOOD, 1716 Locust St., LS-221, Des Moines, IA 50309-3023** or send us an e-mail at askwood@meredith.com. For immediate feedback from your fellow woodworkers, post your questions on one of our woodworking forums at www.woodmagazine.com/forums

Self-centered kit.



Being self centered is sometimes a good thing. Get perfectly centered pilot holes every time with this **3-Piece Self-Centering Bit Set**. For more innovative products, visit rockler.com or call 1-800-279-4441. To call the store nearest you, dial 1-877-ROCKLER.

ROCKLER®
WOODWORKING AND HARDWARE
Create with Confidence™

Circle No. 661

Get Rid of Your Gutters!

RAINHANDLER

Self-Cleans.

Unique louver design allows leaves and debris to blow or wash away.

Protects Property.

The Rainhandler self-cleaning system eliminates clogged, over-flowing gutters and downspouts. No ground erosion. No more destructive ice dams from frozen gutters.

Protects You.

The Rainhandler self-cleaning system protects you from the need to climb ladders and roofs to clean clogged gutters.

Prevents Erosion.

Rainoff is converted to a 2 to 3 foot wide band of soft rain-sized droplets sprinkling the landscaping.

Maintains Itself.

The all-aluminum, never-rusting, maintenance-free Rainhandler louvers make messy, deteriorating gutters and downspouts history.

Beautifies.

The Rainhandler system is practically invisible. No gutters, downspouts, leaders or splash blocks to detract from the natural beauty of your home.

Installs Easily.

Each 5-foot section comes with 3 brackets & 6 screws. Do your entire home in 3 or 4 hours.

Guarantees.

Performance satisfaction is guaranteed for one full year. 25-year warranty.

Phone or Write for **FREE** Information

RAINHANDLER
from Savetime Corp.
Dept. WM0206

2710 North Avenue/Bridgeport, CT 06604
1-800-942-3004/Fax 1-800-606-2028

Name _____
Address _____
City _____ State _____
Zip _____ Email _____

www.rainhandler.com/wm

Circle No. 1305

magazine rack

An option to the magazine rack/table on page 76, this handsome design offers a lower profile.



To modify the magazine rack/table, simply eliminate the tabletop and uprights and add a handle. It's that easy. Here's how.

When laying out the ends (A), mark the centers of two additional counterbored shank holes in each part for attaching the handle (K), where shown on **Drawing 1**. Drill these counterbored holes at the same time you drill the counterbored holes for attaching the rails (B, C). Then follow the instructions on page 76 for adhering the end patterns to the ends and bandsawing them to shape. Eliminate the 1¼"-long flat portion for the posts (H) by sanding the top edge to a continuous smooth curve.

Proceed with the original instructions. To make sure the optional handle (K) is the same length as the bottom rails (B) and top rails (C), cut these parts to length at the same time. Eliminate the posts (H), cleats (I), and top (J). Make four additional ⅜" plugs ⅞" long. Assemble the rack.

To form the cutout in the blank for the handle (K), bore two 1" holes with a

ALIGN THE HANDLE FOR DRILLING

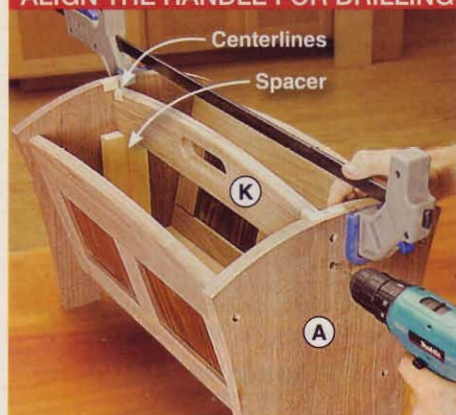

Rest the handle (K) on 7"-long spacers, align the centerlines, and clamp it in place. Using the end (A) holes as guides, drill pilot holes.

1 END (Outside face shown)

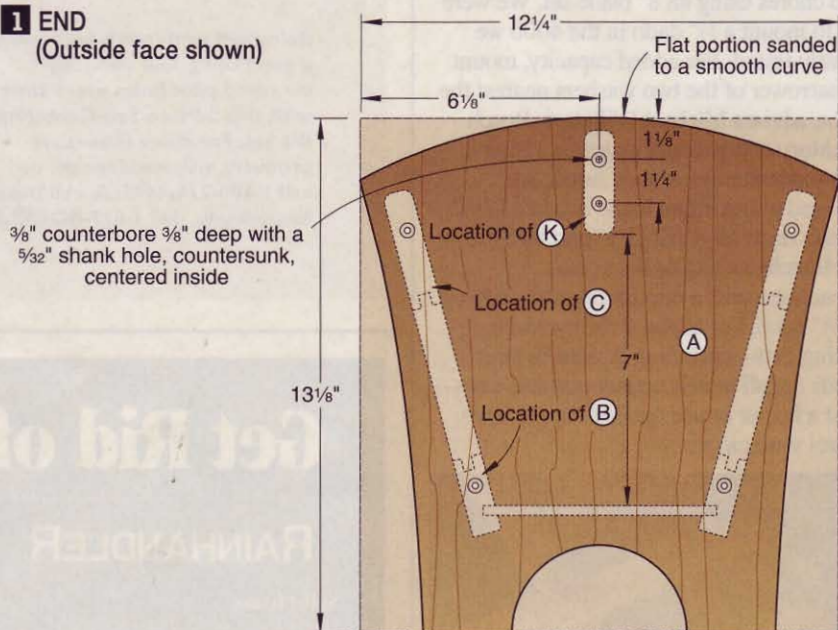

2 HANDLE

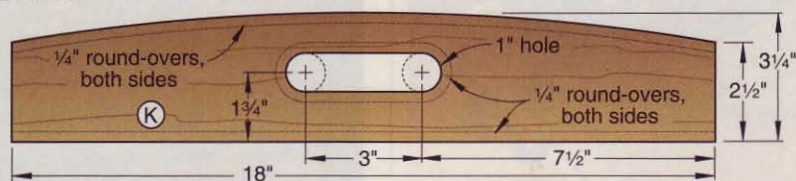

Forstner bit, where dimensioned on **Drawing 2**. Then draw lines tangent to the holes, and remove the material between them with a jigsaw. Sand the handle opening smooth. Now mark the midpoint and endpoints of the curved edge, use a fairing stick to connect the points, draw the curve, and jigsaw and sand it to shape. (For a free downloadable fairing stick plan go to woodmagazine.com/fairing.) Next rout ¼" round-overs along the top, bottom, and cutout edges. Finish-sand the handle.

To install the handle, first apply masking tape and mark centerlines on the top inside faces of the ends (A) and the top edge of the handle at each end. Then cut a pair of 7"-long spacers. Now position the handle between the ends (A) and drill pilot holes into the ends of the handle, as shown at left, and fasten it with screws.

Glue ⅜" plugs into all the counterbores and sand them flush. Inspect all the parts and finish-sand where needed. Apply a clear finish, as directed on page 79. 🌲

2 ways to enhance walnut's beauty

You can make naturally beautiful walnut look and feel even better with a filled-pore or multihued finish. They're both simple to do.



Finish 1 yields a filled-pore, super-smooth surface.

Finish 2 brings out the multiple hues in walnut.

1. Apply a super-smooth, filled-pore finish

If you've ever messed with (underline "mess") a filled-pore finish, you likely longed for some alternative to grain fillers and sealer coats. There is such a system, and it produces similar results from just stain and sandpaper.

Begin by sanding your workpiece up to 220 grit. That's higher than we normally recommend, but it prepares the surface for the 400-grit wet sanding needed to create the fine particles that fill the wood pores.

Next, cover the surface with a generous amount of oil-based stain. Atlanta-based finishing professional Alan Noel uses Minwax golden oak stain for his walnut projects. Any stain will do, so long as it doesn't contain pigment. To spot a pigmented stain, look for thick, dark pigment deposits at the bottom of an unmixed can. Watco Danish Oil is another pigment-free option.

Wet-sand the stain in a circular motion using 400-grit, wet-dry abrasive, as shown *far right*. We used a firm sanding pad for a flat, smooth surface, but a flexible pad or just your fingers works as well. Wood dust



You won't be able to resist running your fingers over surfaces treated to this silky-smooth, filled-pore finish.

created while sanding mixes with the oil in the stain and fills the wood pores. The tiny amount of binder in the stain helps lock the filler in place.

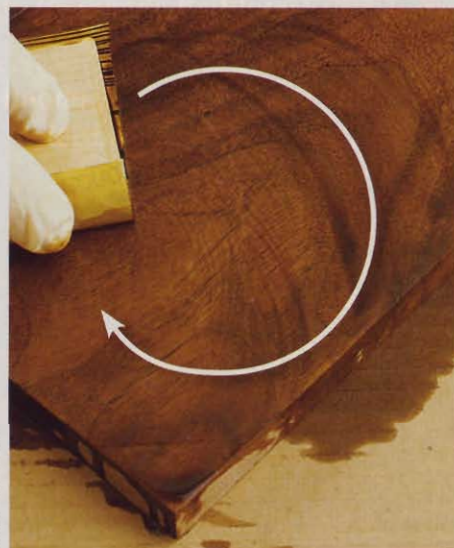

Sanding in a circular motion using stain as a lubricant creates a pore-filling slurry of sawdust and binder from the stain.

So how much should you sand? "I sand until I think I'm all done, and then sand the same amount again," Alan says. Once the sanding is complete, wipe the stain off with *continued on page 34*

strokes perpendicular to the grain. This helps prevent accidentally pulling the sawdust/stain mixture out of the pores. A cloth folded to create a firm pad with a smooth wiping surface works well for this. Avoid leaving wiping marks on the surface.

After the stain dries, you can test for smoothness by running your hand across the surface. Even if you discover a rough spot or insufficiently filled pores, this system allows you to flood the surface again and resume sanding. Then finish with varnish or spray lacquer.

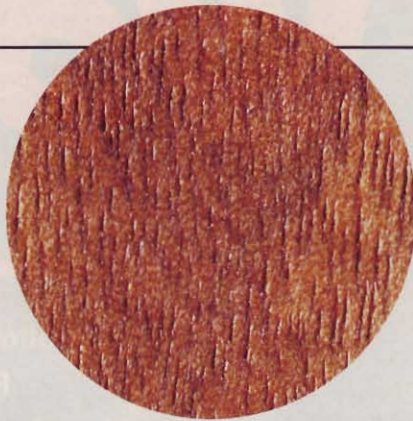

Oil/varnish finish leaves pores unfilled.

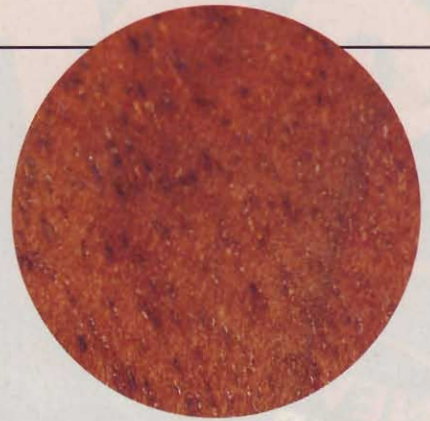

Partially filled pores smooth the surface.

2. Highlight walnut's rich color with a multilayered finish

Walnut hides a multitude of hues beneath its unfinished surface. This multistep finish enhances walnut's color palette, giving it greater depth and richness.

For simplicity, we used medium- and dark-brown oil-based stains (Varathane mission oak and dark walnut, in this case) instead of less readily available toners. You'll also need yellow dye, which can be ordered from several mail-order suppliers. (We used Lockwood #5230 lemon yellow dye from W.D. Lockwood & Company, 866/293-8913 or wdlockwood.com.) To seal the surface, we used aerosol lacquer sanding sealer and semigloss aerosol lacquer.

Step 1: Start by sanding the workpiece to 180 grit and wiping it with a water-dampened rag. Scuff-sand just enough to remove any raised grain. Then apply water-

soluble yellow dye to the wood, as shown *below left*, allowing it to penetrate beneath the surface. Wipe away any excess and allow it to dry.

After you lightly scuff-sand and vacuum the dyed surface, seal the dye coat with aerosol lacquer sanding sealer. You also can use semigloss aerosol lacquer as a seal coat.

Step 2: Using 400-grit sandpaper, lightly sand the sealer coat with the grain until the surface is covered with fine, even scratches to catch the stain pigments. Apply a coat of dark walnut stain over the sealer, as shown *below*. Carefully wipe away the excess, but take care not to remove it completely. This creates a toner coat on the sealer. You'll still see some of the yellow highlights, but they won't appear as bright dye colors. At this stage, it's possible to wipe away different

amounts of stain, leaving slightly more where you want to compensate for light spots or streaks of sapwood.

Once this stain-based glaze dries, seal it with semigloss aerosol lacquer.

Step 3: Lightly but evenly, sand the lacquer with 400-grit sandpaper to create another surface of fine, even scratches as before. Cover this coat of lacquer with medium stain, as shown *below*, again being careful to avoid wiping away too much. This is another opportunity to vary the amount of stain you leave behind to darken light areas of the wood.

Step 4: After the final coat of stain dries thoroughly, spray on two or more coats of aerosol lacquer to lock this glaze coat in place, seal the surface, and bring out the wood's subtle shades. 🌲



STEP 1

This dye dries a bright yellow, highlighting the lighter tones in the wood. Lightly scuff-sand any raised grain before sealing the surface.



STEP 2

Yes, it's yellow, but not for long. A sealer over the dye makes it easy to control how much the stain-based glaze darkens the wood.



STEP 3

While the second glaze coat is still moist, you can get an approximate idea of how the wood will look with a clear topcoat.

shop-proven products

These woodworking wares passed our shop trials.

Trim router sports big-router features

Look up “overkill” in the dictionary, and you might see it defined as “using a 2- or 3-hp router to rout a 1/8” round-over or chamfer on a workpiece.” Truth is, a trim router (sometimes called a laminate trimmer) easily handles many routine router tasks, but some woodworkers don’t take it seriously as a woodworking tool. Bosch brings new respectability to the trim router with its Colt Palm Router (PR20EVSK).

The Colt’s housing with soft-grip material fits comfortably in one hand, and a pair of textured surfaces on top of the base provide good purchase for two fingers to keep the base flat on a workpiece, as shown at *right*. Its 1-hp, variable-speed motor (16,000–35,000 rpm) proved more than up to the task of routing 3/16” rabbets 1/4” deep into walnut without the slightest hesitation, thanks to the tool’s electronic speed control.

Bosch engineers designed some other features of its big routers into the Colt as well: Unlocked, the base slides freely up

and down the motor for large depth changes, but a simple twist of the base engages the easy-to-use microadjust system. A spindle lock allows one-wrench bit changes, and the flat base sides run more reliably along a straightedge than the round bases on many trim routers.

I found only one weak point on the Colt: Out of the box, it won’t accept guide bushings. For that, you’ll need to buy one of the accessory subbases that fit Bosch’s own guide bushings.

The variable-speed Colt I tested also comes in a larger set, called the installer’s kit (PR20EVSNK, \$200), that includes offset and tilt bases as well as guiding accessories. You also can buy a single-speed version (PR10E) for \$100.

—Tested by Bob Wilson



Colt Palm Router PR20EVSK

Performance	★★★★☆
Price	\$130

Bosch Power Tools and Accessories
877/267-2499; boschtools.com

Try your hand at vacuum veneering for less than \$60

Solid-wood veneers dress up a project with a beautiful skin, while saving you money. For example, a large project made entirely from highly figured solid wood would cost an arm and a leg. With veneers, you can use man-made sheet goods, such as MDF, for the substrate. Clamping veneer gets tricky, though, especially in the middle of a workpiece where you need pressure beyond the reach of your clamps.

That’s why many pro woodworkers turn to a vacuum press. They glue the veneer to the substrate, put the whole thing inside a heavy-duty, airtight bag, and then suck all the air out of the bag with a vacuum pump, clamping the veneer tightly to the substrate, even on curved surfaces. Such systems can cost hundreds of dollars.

Now comes a vacuum press as capable as the pricey systems for a lot less. Instead of an electric pump, the Vacuum Veneer Press from Lee Valley Tools uses a hand pump—the same kind wine aficionados use to seal an opened bottle—to create the suction. It takes more time, but it works great.

I first veneered a small panel using the Vacuum Veneer Press. After gluing the

veneer to the MDF substrate, I slipped the panel into a mesh bag (that prevents trapped air between the bag and workpiece), and then into the 26×28” vinyl bag, sealing it with the included reusable butyl tape. Next,

I seated the vacuum pump on the one-way valve and pumped it until I couldn’t pump any more. I let the assembly sit overnight, and the next morning was relieved to find that the bag held its vacuum, and my inspection of the panel after removing it from the bag revealed no bubbles under the veneer. A perfect job.

I also used the Vacuum Veneer Press to make a bentwood lamination wrapped against a form. Again, the results were outstanding, with minimal springback from the lamination after it was removed from the form.

—Tested by Kevin Boyle

Vacuum Veneer Press (55K67.26)

Performance	★★★★☆
Price	\$57; replacement bag, \$40

Lee Valley Tools
800/871-8158; leevalley.com



continued on page 38

Outfeed stand supports through thick and thin

An outfeed support stand that holds up a workpiece as it comes off the tablesaw can sometimes seem more of a nuisance than it's worth. My roller stand's small footprint makes it easy to topple, especially if I underestimate how much the workpiece sags coming off the back of the saw. And a slightly off-kilter roller tends to steer the workpiece, ruining my cut.

Lee Valley's Ultimate Outfeed Stand does a nice job of addressing both of those common problems. As you can see from the photo, right, its broad 22x29" footprint makes it virtually tip-proof. Plus, this thing adjusts eight ways from Sunday, including a fine height adjustment, head tilt correction, and even a leveling foot to compensate for an uneven floor.

Eight independent swivel casters line the head of the stand, preceded by a steel ramp that gently guides a sagging workpiece up to wheel level. I ripped an 8' length of 12"-wide pine and the wheels rotated to support the stock without pulling it. I even

purposely rotated the stand about 30° off axis and still felt no effect from the rollers. I thought narrow stock might get trapped between the wheels, but ripping 1"-wide strips of ¾" red oak proved no problem:

The wheels simply parted and allowed the ramp to support that narrow stock.

I did notice that the ramp prevents the casters from rotating 360°, so pulling a workpiece back across the stand after shutting off the saw causes some drag. And, although the Ultimate Outfeed Support Stand's 14½"-wide head is generous, it's still not wide enough to support both the keeper and waste piece when ripping a 4x8' sheet of plywood. For that you'll need two stands.

—Tested by Charlie Bartlett



Ultimate Outfeed Support Stand (50U01.01)

Performance ★★★★★

Price \$90

Lee Valley Tools
800/871-8158; leevalley.com

NEW

Introducing the K3 Kreg Jig®

Patent Pending

2 Ways to Buy!

K3 Master System

- (1) Interchangeable Drill Guide
- Benchtop Base
- Portable Base
- Dust Collection Shroud
- Material Support Stop
- Premium Face Clamp
- Drill Bit
- 6" and 3"- #2 Driver Bits

US MSRP: \$149⁹⁹

K3 Standard Pack

- Interchangeable Drill Guide
- Portable Base
- Premium Face Clamp
- Drill Bit
- 6"- #2 Driver Bit

US MSRP: \$79⁹⁹

Upgrade the Standard Pack later...

Convert your K3 Standard Pack to a K3 Master System with our K3 Upgrade Kit.

800-447-8638
www.kregtool.com

The Blue Mark of Quality.

Just when you thought Pocket Hole Joinery couldn't get any better, we've launched the exciting new K3 Kreg Jig®. Packed with innovative features, this pace-setting tool is poised to take Pocket Hole Joinery to a whole new level!

Visit our website for an interactive demo... www.kregtool.com

SMALL SIZE...LARGE PERFORMANCE!

JDS Cyclones



The new JDS Cyclones are here! With a compact design, powerful motor, and efficient 1 micron filtering, these cyclones are perfect for any shop.



2 HP Cyclone-II
\$999.00

3 HP Cyclone
\$1495.00

2 HP - 1900 CFM
11.2" Static Pressure
72" Tall!

3 HP - 2050 CFM
12.4" Static Pressure
87" Tall!

Another quality product from



800.480.7269

www.jdstools.com

Circle No. 1974

shop-proven products

Diamond paste kit puts a mirror finish on cutters

As a college woodworking instructor, I constantly preach to my students (and anybody else who will listen) about the importance of keeping cutting tools sharp. Most woodworkers will be satisfied with the sharpening results they get from a good set of waterstones, but for those who demand a supersharp mirror finish on their chisels and plane irons, the answer is diamond pastes. Beta Diamond Products offers an affordable kit of pastes that takes tool sharpening to that higher level.

The process starts with dispensing a half-gram dollop of diamond paste into a dime-size pool of the included lubricant, and mixing the concoction into a slurry on a smooth, flat piece of hard maple. Beta Diamond's color-coded syringes make it easy to meter out the right amount of paste and help keep the four progressively finer grits in order. Tiny figure-eight strokes followed by a back-and-forth motion in line with the bevel quickly put on a mirror finish as I stepped up through the grits (600 to 8,000 grit).

I've used diamond pastes before, but I'm impressed with this kit from Beta products. I observed consistent improvement in the surface quality of my tools with each grit change, without seeing any of the cross-contamination of grits that I've seen in pastes from other manufacturers.

—Tested by Tim Peters

Diamond sharpening compound

Performance	★★★★★
Price	\$38 ppd.

Beta Diamond Products
800/975-9009; betadiamond.com

Whether You Call It A Specifications Manual
Or A Catalog For Woodworkers —



Either Way, It's Free!

It's so much more than a catalog; it's a specification-packed, installation-simplifying, idea-inspiring resource. It's also more than hardware. It's got just about everything you need for cabinet making with the deepest inventory available so, unlike other suppliers, your design is never limited by our selection.

All this — and it's free!

YOUR SOURCE FOR



Circle No. 713

Woodworker's **HARDWARE**

We supply all your cabinet hardware needs!

For your complimentary catalog, call (800) 383-0130
or visit us online at woodworkershardware.com

Promotion Number 464



continued on page 42

C-clamps open wide, and then close quickly

C-clamps have been around about as long as dirt, but have fallen out of favor in the woodworking shop over the last 20 years or so. As life got faster, we got less patient, and quick-adjusting one-handed bar clamps left the tedious C-clamp in their dust. Now Stretta's Extendable C-clamps threaten to bring old-school clamps back in vogue.

The "fixed" jaw on this all-steel clamp isn't really fixed at all: Tilt the jaw in, as shown in the top photo at right, and it slides inside the body of the clamp to expand or reduce the clamping capacity. Tilt it back (bottom photo) and it locks back in rock-

solid. (The jaw locks in at 1/8" increments.) After a little practice, I found it easy to get within 1/2" or so of the size I needed just by eyeballing it.

Although they're still not quite as fast as the ever-present one-handed bar clamp, Extendable C-clamps provide the same incredible clamping pressure as an ordinary C-clamp, with no observable flex. The soft pads that cover the steel jaws prevented workpiece marring, despite that stout clamping pressure.

Stretta Extendable C-clamps come in four size ranges: 2-3", 3-5", 4-7", and 5-9". You

can buy them individually or in sets. (Check the manufacturer's Web site for details on these sets.)

—Tested by Dean Fiene

Extendable C-clamps

Performance	★★★★★
Price	\$6-\$15, individual clamps; \$31-\$43, sets

Stretta, Inc.
206/938-1064; strettausa.com



About our product tests

We test hundreds of tools and accessories, but only those that earn at least three stars for performance make the final cut and appear in this section. Our testers this issue include: college woodworking professor **Tim Peters**; tool aficionados **Charlie Bartlett** and **Dean Fiene**; and **WOOD** magazine staff members **Kevin Boyle** (senior design editor), and **Bob Wilson** (techniques editor). All are avid woodworkers.



CO₂ Laser Engraving, Cutting, and Marking Systems Starting at \$9,995!

Unmatched Quality, Performance, and Reliability.



Adding engraving capabilities to your business has never been more affordable. Engrave and cut photos, clipart, logos and more - and it's as easy to operate as a printer. Call us today at toll free 888-437-4564 to receive a free brochure, sample kit, and CD demo of the system in action!



16371 Table Mountain Pkwy. • Golden, CO 80403
Toll Free: 1.888.437.4564 • Phone: 303.277.1188
sales@epiloglaser.com • www.epiloglaser.com

country classic chimney cupboard

Whether you need storage for kitchen items, linens, or clothing, this down-home cabinet fills the bill.

Suitable in any room or a hall, this tall and slender unit, with adjustable shelves and a drawer, measures 59 $\frac{3}{4}$ " tall and occupies only about 12 $\frac{3}{4}$ ×20" of floor space. Even better, it's made from inexpensive, edge-joined pine panels (see the sidebar, *opposite page, bottom*) and beaded tongue-and-groove planking for the back. Depending on your preference, you can finish the project with a shellac (inset photo) or other clear finish, paint it to match your decor, or apply a paint-and-glaze finish for an aged appearance, as shown left. To learn about this technique from a master finisher, see *page 50*.

Start with the case

1 From $\frac{3}{4}$ "-thick edge-joined pine panels, cut the sides (A); top, bottom, and divider (B); and face-frame stiles (C) and rails (D) to the sizes listed in the **Materials List**. (We centered the parts over the panel joint lines for the best appearance.)

2 Using a dado blade in your tablesaw and an auxiliary fence attached to the rip fence, cut $\frac{3}{4}$ " dados and rabbets $\frac{3}{8}$ " deep on the *inside* face of the sides (A), where dimensioned on **Drawing 1**. Then, with the dado blade partially buried in the auxiliary fence, cut a $\frac{5}{16}$ " rabbet $\frac{3}{8}$ " deep along the *back* edge of each case side.

3 Mark centerpoints for shelf-pin holes on the sides, where dimensioned. Using a $\frac{1}{4}$ " Forstner or brad-point bit in your drill press and a fence to keep the holes aligned, drill $\frac{3}{8}$ "-deep holes at the centerpoints.

4 To form a $\frac{1}{8}$ " slot $\frac{3}{4}$ " long in each side, mark centerpoints for $\frac{1}{8}$ " holes $\frac{3}{8}$ " apart on the *inside* face, where dimensioned on **Drawing 1a**. Using a $\frac{1}{8}$ " brad-point bit, drill the holes. Then drill overlapping holes to complete the slots.

5 Make two copies of the full-size end patterns for the sides from the **WOOD Patterns®** insert. Spray-adhere the patterns to the bottom of each side (A), aligned with the front and back edges, where indicated. (You'll need to flip the patterns over for the left side.) Draw lines to connect the patterns. Then bandsaw and sand to the lines. Remove the patterns using a cloth moistened with paint thinner.



For a rustic look, apply a shellac finish (superblonde shown).

1 SIDE
(Inside face of left side shown)

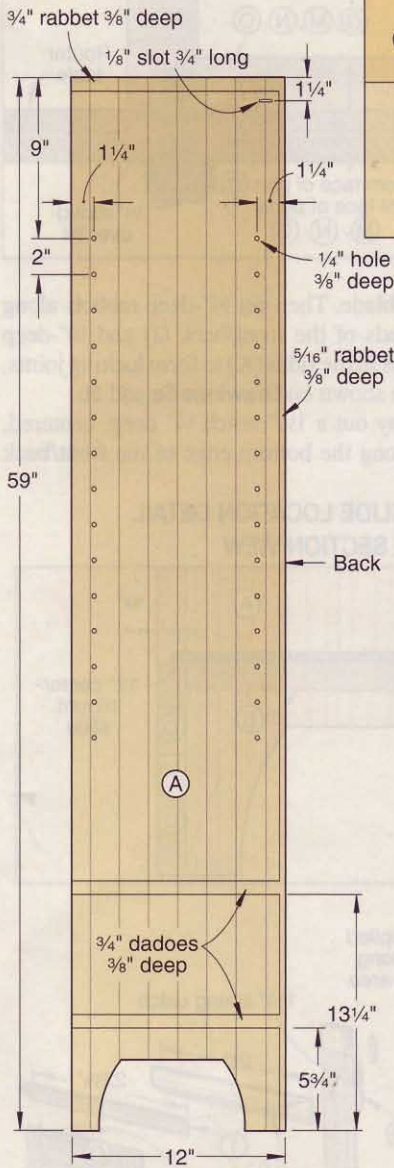

Note: Right side is a mirror image.

1a SLOT DETAIL

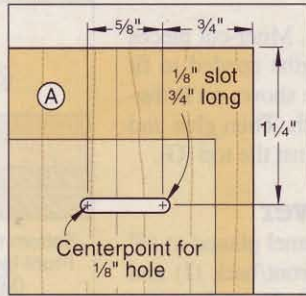

6 Sand the sides (A) and top, bottom, and divider (B) smooth with 220-grit sandpaper. Then glue and clamp the parts together, as shown in **Photo A**.

7 Make two copies of the full-size face-frame stile end pattern.

Spray-adhere a pattern to the bottom of each face-frame stile (C), aligned with the outside edge, where noted. (You'll need to flip the pattern over for the left stile.) Bandsaw and sand to shape. Remove the patterns.

8 To assemble the face frame, draw centerlines for #0 biscuit slots on the front faces of the stiles (C) and rails (D), where dimensioned on **Drawing 2**. Adjust your biscuit joiner to center the cutter on the 3/4" thickness of the parts. Plunge the slots. Then glue, biscuit, and clamp the stiles and rails together, checking for square.

9 Glue and clamp the face frame (C/D) to the case (A/B), as shown in **Photo B**. After the glue dries, sand the face-frame edges smooth and flush with the case.

Complete the case

1 To form the back (E), cut six 53 1/4"-long pieces from 5/16 x 3 1/2 x 96" beaded tongue-and-groove planking. Lay out the planks on your workbench, and fit the tongues and grooves together. Measure the width of the rabbeted opening in the back of the case. Center this measurement on the assembled planks. Then trim equal amounts off the outside edges of the first and last planks. Sand the back smooth, and set it aside.

2 From your edge-joined panels, cut the shelves (F) and top (G) to the sizes listed. Using your table-mounted router, rout a 1/4"

ASSEMBLE THE CASE

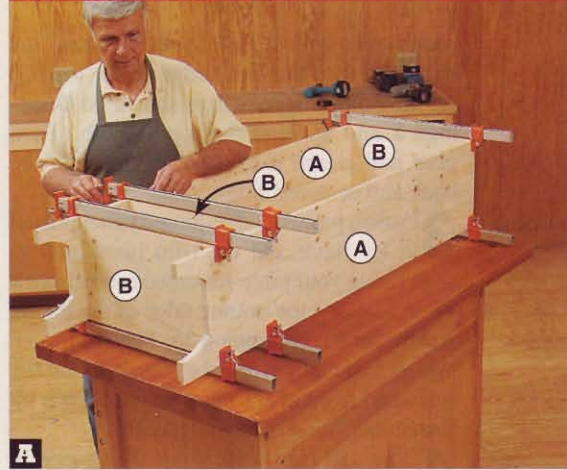

Keeping the front edges flush, glue and clamp together the sides (A) and top, bottom, and divider (B). Check the case for square.

ADD THE FACE FRAME

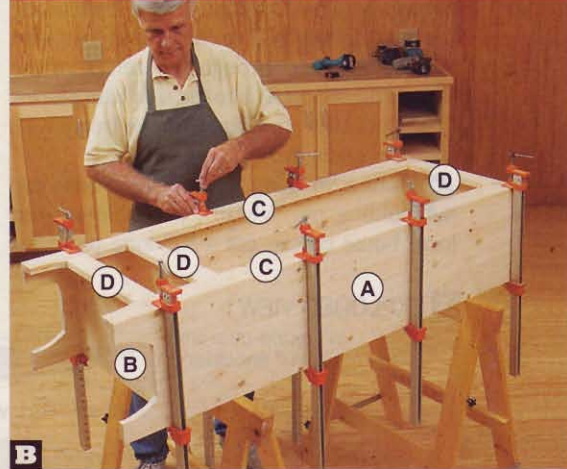

With the case (A/B) on sawhorses, glue and clamp the face frame (C/D) to the front of the case, keeping the case/frame edges aligned.

2 FACE FRAME BISCUIT-SLOT LOCATIONS

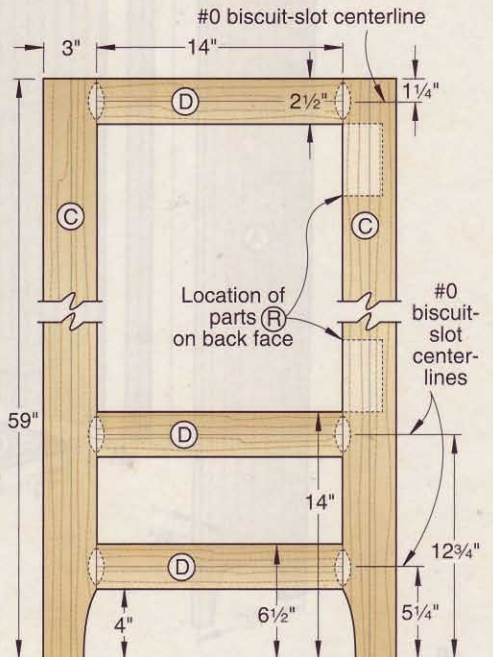

Edge-joined panels: a good choice for pine projects

You can use 3/4"-thick, common-grade pine to build the chimney cupboard. Or, as Master Craftsman Chuck Hedlund did for our project, you can make it from 3/4" edge-joined pine panels, available at your local home center. The panels—



presanded to a uniform thickness and made with strips of wood less than 2" wide, as shown at left—are flat and straight with tight knots, ready for cutting to size. The color and grain matching of the strips in these

panels generally is quite good, but you'll want to select them carefully for best appearance if you plan to apply a stain or clear finish to your project.

Although costing a little more than common lumber (locally per board foot, the panels cost \$2.59 compared to \$1.85 for no. 2 common-grade pine), you won't waste material dealing with such defects as cupping, twisting, cracks, and loose knots.

Before buying, make sure you measure the thickness, width, and length of the panels. The ones we used, manufactured by Weyerhaeuser, measured exactly as specified on the packaging. But some other manufacturers' panels we found measured only 1 1/16" thick and 1/8" shy in width or length. The panels typically come in 12" to 20" widths and 3' to 8' lengths.

round-over with a $\frac{1}{16}$ " shoulder along the ends and then the front edge of the top (G) on the *bottom* face, where shown on **Drawings 3** and **4**. Sand the top smooth. Then glue and clamp it to the case, flush at the back and centered side-to-side.

3 From a piece of edge-joined panel planed to $\frac{1}{2}$ " thick, cut the trim blank (H) to size. Using your table-mounted router, rout a $\frac{3}{8}$ " cove along the bottom edge of the blank, where shown on **Drawing 3a**. Then miter-cut pieces to length from the blank to fit the sides and front of the case, where shown on **Drawing 3**. Sand the trim smooth.

4 Glue and clamp the front trim piece in place. Next, apply glue along a 2"-long area on the back face of the side trim pieces at the *front* ends, where shown. Clamp the pieces to the case, ensuring tight mitered corners with the front trim. Now, from inside the case, drive #8x1" roundhead screws with $\frac{1}{4}$ " flat washers through the center of the slots in the sides (A) into the side trim pieces. (The slots allow the trim to move freely with seasonal changes.)

5 From a 96"-long piece of pine base cap molding no. WM167, available at your local home center, cut a 52"-long piece for

the base cap trim blank (I). Miter-cut pieces from the blank to the lengths needed to fit around the trim (H), where shown on **Drawing 3**. Sand the trim smooth. Then glue and clamp it in place, tight against the top (G).

Next up, the drawer

1 From an edge-joined panel planed to $\frac{1}{2}$ " thick, cut the drawer front/back (J) and sides (K) to the sizes listed. Then, from $\frac{1}{2}$ " birch plywood, cut the bottom (L) to size. Sand the parts smooth.

2 Using a dado blade in your tablesaw, cut a $\frac{1}{2}$ " groove $\frac{1}{4}$ " deep $\frac{1}{4}$ " from the bottom edge on the *inside* face of the front/back (J) and sides (K) to fit the plywood bottom (L), where shown on **Drawing 5**. Switch to a $\frac{1}{4}$ "

4 ROUTING THE $\frac{1}{4}$ " ROUND-OVERS

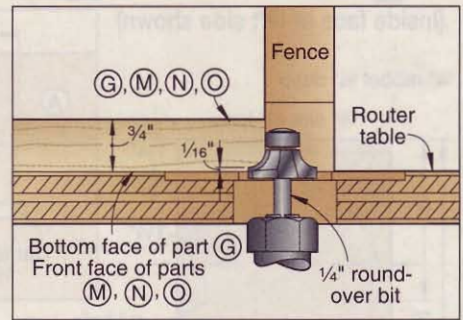

dado blade. Then cut $\frac{1}{4}$ "-deep rabbets along the ends of the front/back (J) and $\frac{1}{4}$ "-deep dadoes in the sides (K) to form locking joints, where shown on **Drawings 5a** and **5b**.

3 Lay out a $\frac{1}{2}$ " notch $\frac{1}{4}$ " deep, centered, along the bottom edge of the front/back

3a TRIM FRONT SECTION VIEW

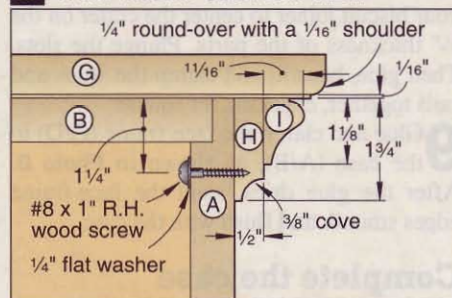

3b SLIDE LOCATION DETAIL SIDE SECTION VIEW

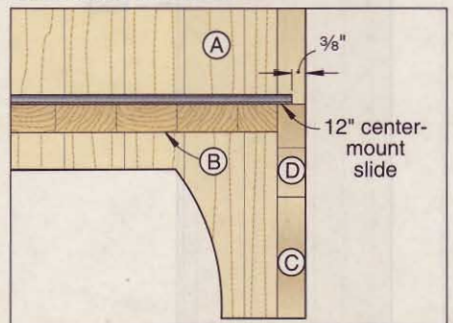

3 EXPLODED VIEW

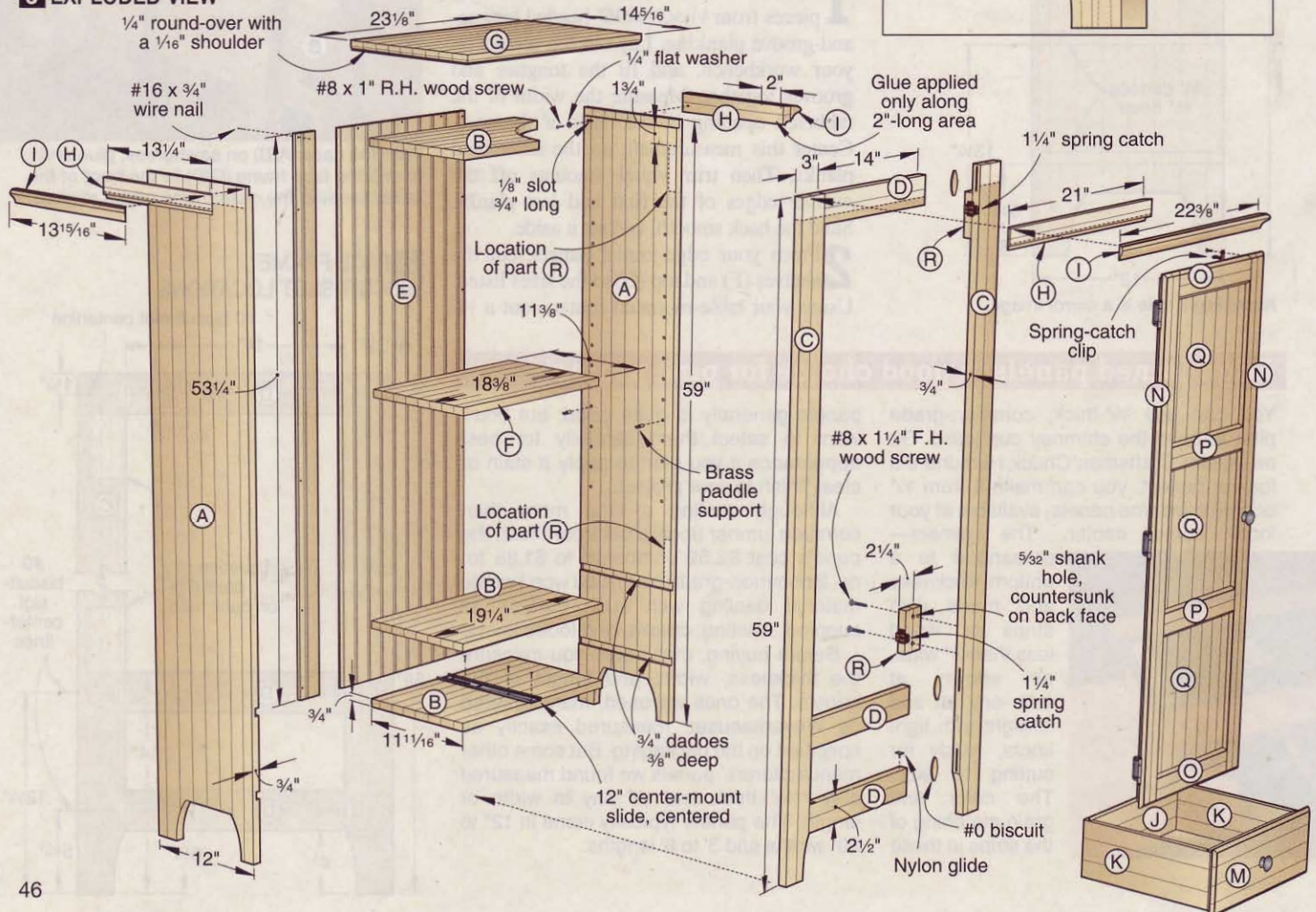

5a DRAWER LOCKING JOINT DETAIL

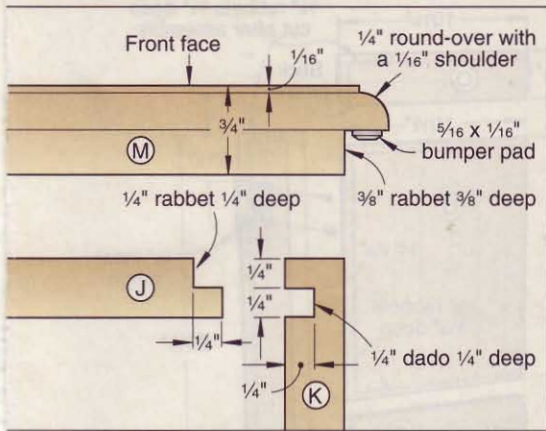

(J), to receive a center-mount slide, where shown on **Drawing 5**. Holding the parts on edge and using the dado blade in your tablesaw, make multiple passes to cut the notches to shape.

4 Drill four countersunk shank holes on the *inside* face of the front (J) for attaching the face (M), where shown. Then glue and clamp together the front/back (J) and sides (K) with the bottom (L) captured in the $\frac{1}{2}$ " grooves. Check the drawer for square.

5 From an edge-joined panel, cut the drawer face (M) to the size listed. Then rout a $\frac{1}{4}$ " round-over with a $\frac{1}{16}$ " shoulder along the ends and then the edges on the *front* of the face, where shown on **Drawings 4** and **5a**. Now, using a dado blade in your tablesaw, cut a $\frac{3}{8}$ " rabet $\frac{3}{8}$ " deep along the ends and edges on the *back* of the face, where shown on **Drawings 5** and **5a**.

6 Clamp the face (M), centered, to the drawer front (J), aligning the rabbeted edges of the face with the outer edges of the drawer. Using the countersunk shank holes in the front as guides, drill pilot holes into the back side of the face. Drive the screws. Now drill a $\frac{3}{16}$ " hole, centered, through the face and front. Mount a $1\frac{3}{16} \times 1\frac{1}{8}$ " brass knob using a #8-32 $\times 1\frac{1}{2}$ " machine screw (*not* the screw supplied with the knob).

7 Separate the members of a 12" center-mount slide. Using the supplied screws, attach the small member to the drawer bottom (L), centered in the notches in the front/back (J), and tight against the face (M).

8 Using a hammer, tap the nylon glides, supplied with the center-mount slide, into the top edge of the bottom face-frame rail (D) at the ends, where shown on **Drawing 3**.

9 To mount the large slide member to the case bottom (B), where shown, draw a centerline on the bottom with a square. Position the slide $\frac{3}{8}$ " from the front face of the bottom face-frame rail (D), where dimensioned on **Drawing 3b**, with the mounting holes centered over the centerline. Mark the holes with a pencil. Then form pilot holes

5b MACHINING THE DRAWER FRONT/BACK AND SIDES

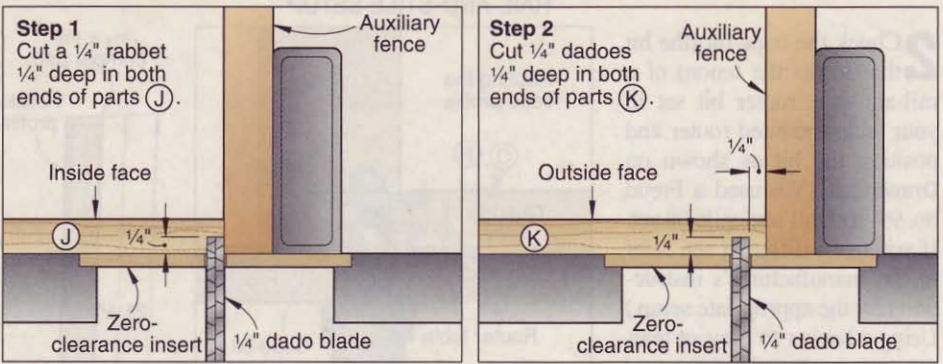

5 DRAWER (Viewed from back)

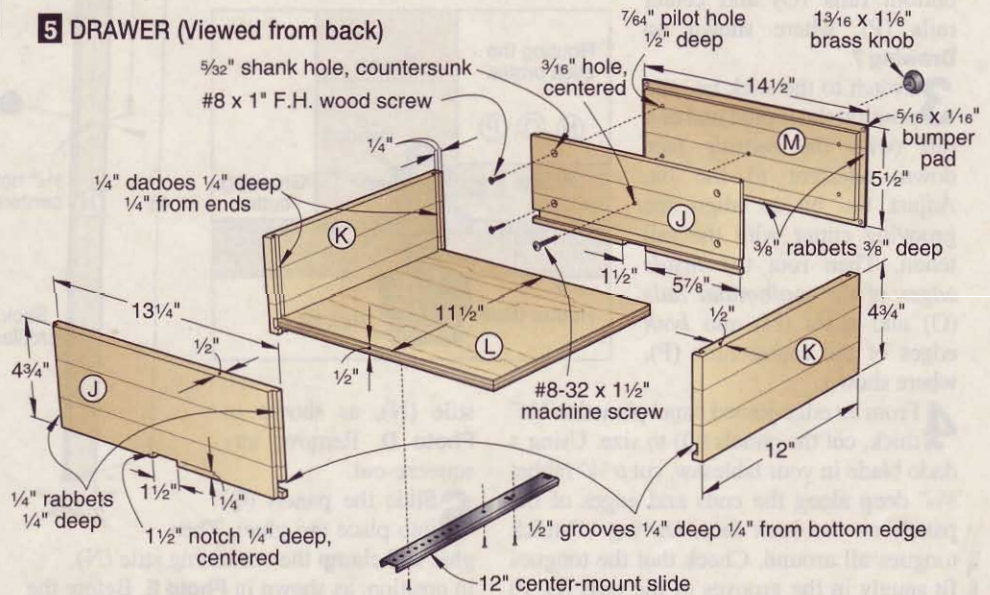

INSTALL THE SLIDE

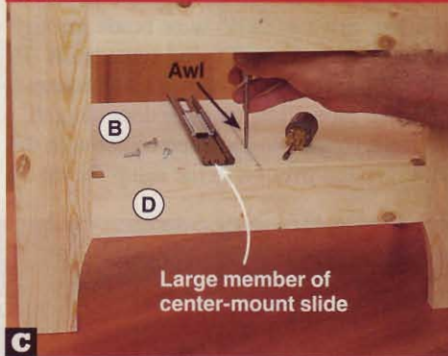

Press an awl at the center of each marked mounting hole on the case bottom (B) to form pilot holes for attaching the large slide member.

with an awl, as shown in **Photo C**. Now screw the slide in place using a short screwdriver. Slide the drawer in place.

Now knock out the door

1 From an edge-joined panel, cut the door stiles (N), top/bottom rails (O), and center rails (P) to the sizes listed. Check both stiles (N) for straightness. If one stile has a slight bow, use it for the hinge side of the door with the bow facing the front, as explained in the **Shop Tip, right**.

SHOP TIP

An easy way to straighten a slightly bowed door stile

When building cabinet doors at least 30" long that mount with three or more hinges, here's a trick for straightening a stile that has a bow of up to $\frac{1}{4}$ ". When assembling the door, locate the stile on the hinged side with the bow facing the front, as shown at *right*. The center hinge(s) straighten the stile by pulling the bowed area in flush against the cabinet.

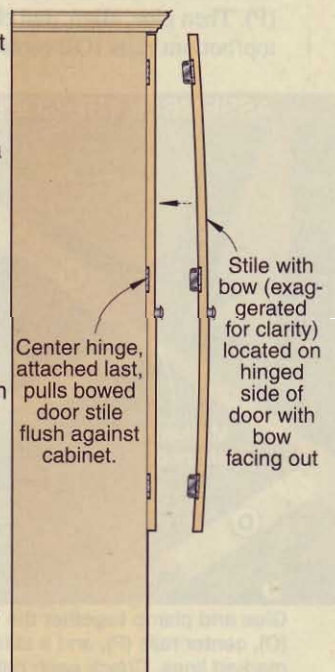

6 DOOR-FRAME RAIL-AND-STILE SETUP

2 Chuck the cope bit (the bit that forms the tenon) of a rail-and-stile router bit set in your table-mounted router and position the bit as shown on **Drawing 6**. (We used a Freud no. 99-260 rail-and-stile bit set. If you use a different set, refer to the manufacturer's instructions for the appropriate setup.) Using a backer to prevent tear-out, rout both ends of the top/bottom rails (O) and center rails (P), where shown on **Drawing 7**.

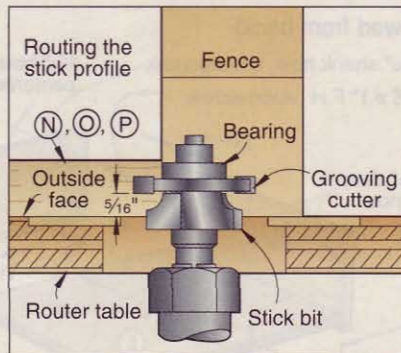
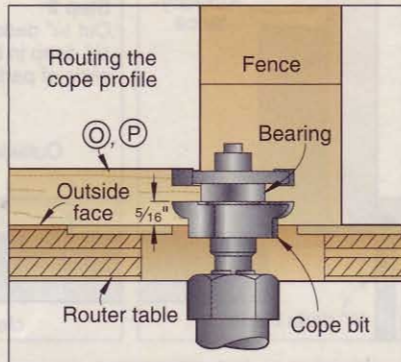

3 Switch to the stick bit, and position the routed end of a rail (with the *outside* face down) adjacent to the bit. Adjust the bit to align the grooving cutter with the rail tenon. Then rout the *inside* edges of the top/bottom rails (O) and stiles (N) and *both* edges of the center rails (P), where shown.

4 From an edge-joined panel planed to $\frac{7}{16}$ " thick, cut the panels (Q) to size. Using a dado blade in your tablesaw, cut a $\frac{3}{8}$ " rabbet $\frac{3}{16}$ " deep along the ends and edges of the panels on the *back* face, leaving $\frac{1}{4}$ "-thick tongues all around. Check that the tongues fit snugly in the grooves of the rails (O, P) and stiles (N). Make any adjustments needed. Sand the panels smooth.

5 To assemble the door, draw alignment lines on the *front* face of both stiles (N), where dimensioned on **Drawing 7**, and centerlines on both ends of the center rails (P). Then glue, align, and clamp together the top/bottom rails (O), center rails (P), and a

stile (N), as shown in **Photo D**. Remove any squeeze-out.

6 Slide the panels (Q) into place (no glue). Then glue and clamp the remaining stile (N) in position, as shown in **Photo E**. Before the glue sets, center the panels in the openings, as shown in **Photo F**. To keep the panels in position, drive $\#18 \times \frac{3}{8}$ " wire brads through the top/bottom rails (O) and center rails (P) into the panels, where shown on **Drawing 7**. After the glue dries, sand the door smooth.

7 Refit your table-mounted router with the $\frac{1}{4}$ " round-over bit in the setup shown on

7 DOOR (Viewed from back)

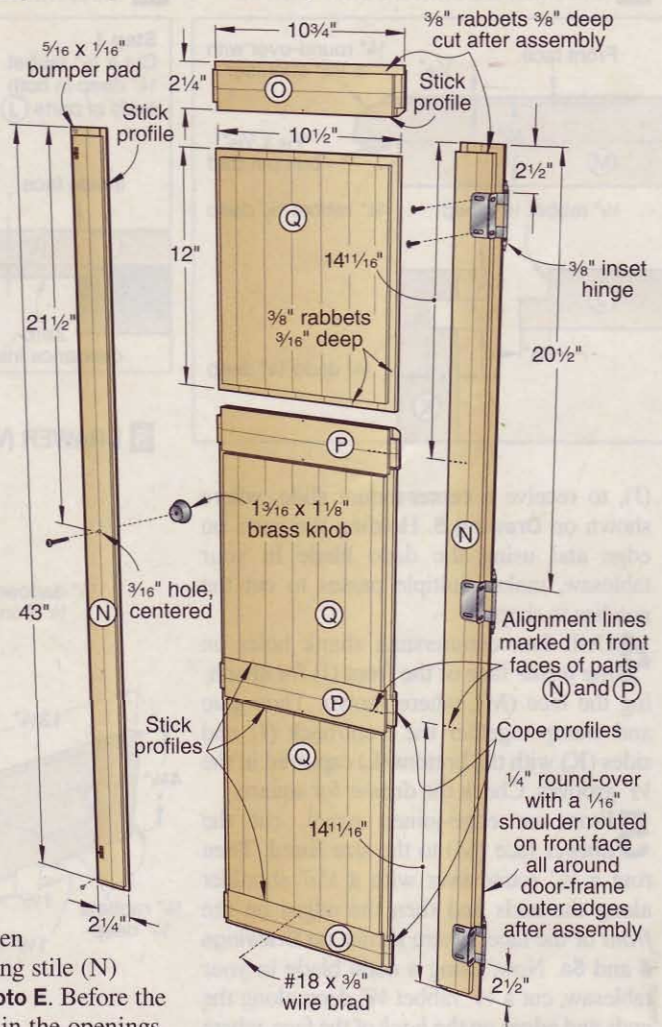

Drawing 4. Then rout around the outer edges of the door on the *front*, where shown on **Drawing 7**. Now, using a dado blade in your tablesaw, cut a $\frac{3}{8}$ " rabbet $\frac{3}{8}$ " deep along the outer edges of the door on the *back*.

8 Position three $\frac{3}{8}$ " inset hinges on a door stile (N), where dimensioned. (If you

ASSEMBLE THE COPE-AND-STICK-JOINED DOOR IN 3 EASY STEPS

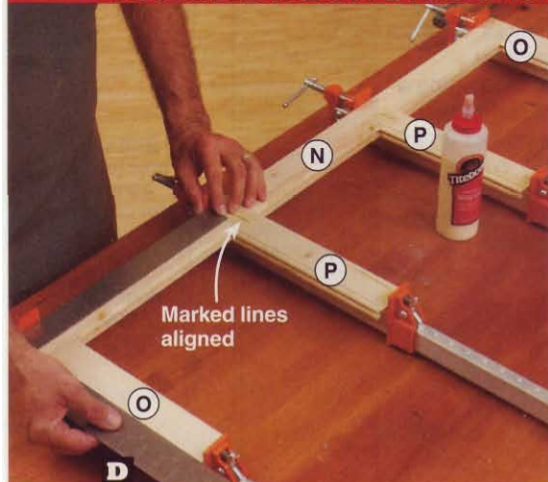

D Glue and clamp together the top/bottom rails (O), center rails (P), and a stile (N), aligning the marked lines. Check each rail for square.

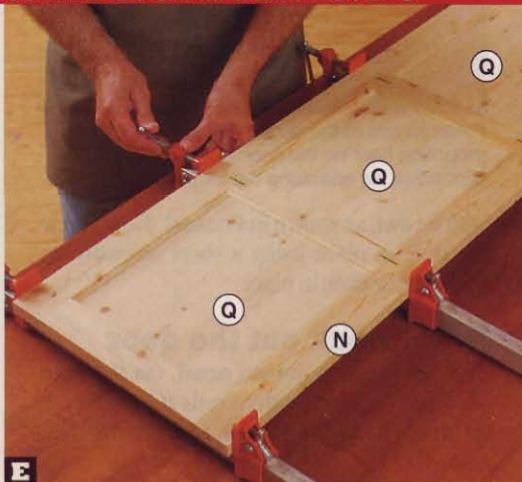

E Slide in the panels (Q). Then glue and clamp the remaining stile (N) in place, again aligning the center rails and checking for square.

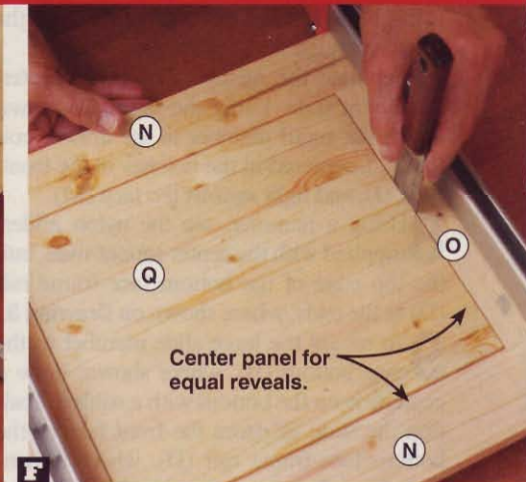

F Before any squeeze-out sets up, turn the door over. Using a putty knife, center each panel (Q) to create equal reveals all around.

painting secrets of a pro

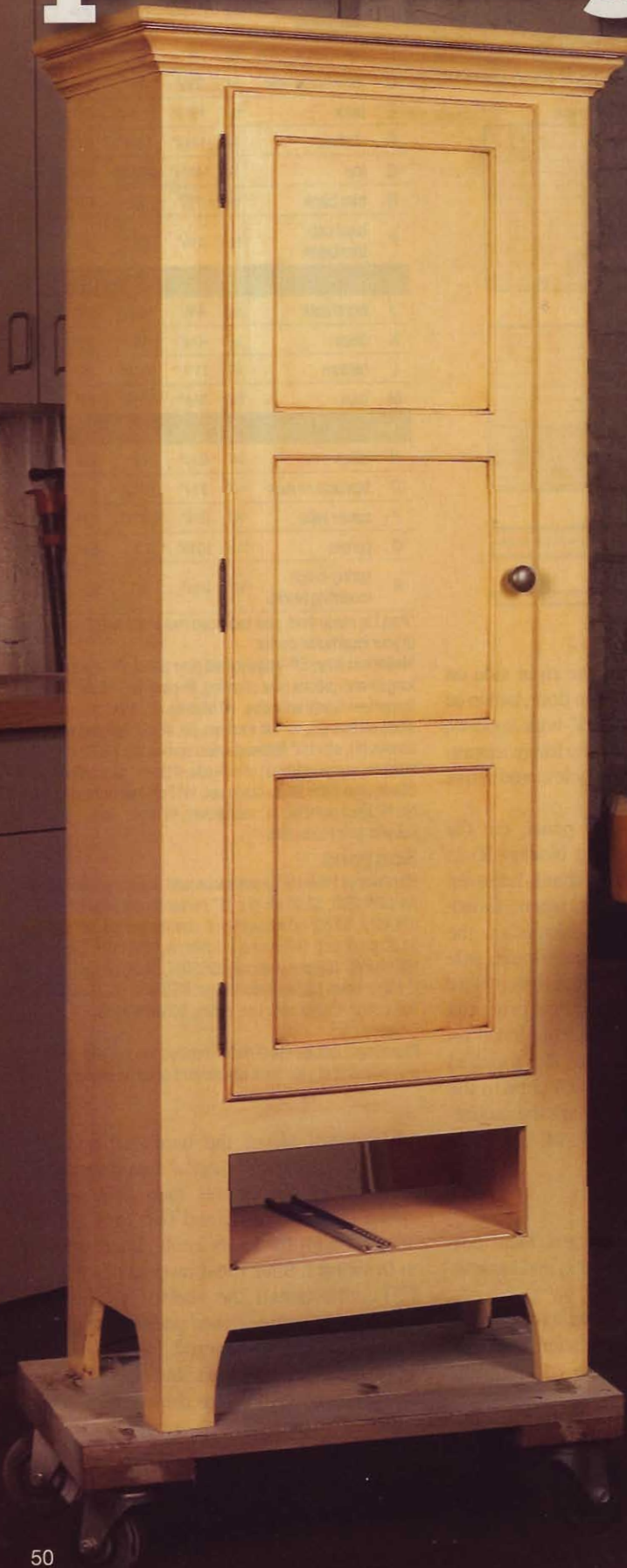

Finishing expert
Jeff Jewitt shows
how to hide
bargain woods
behind a
painted and
antiqued surface.

When it comes to finishing oak, cherry, or maple projects, “paint” sounds like a dirty word. But for inexpensive, less attractive woods, such as pine, poplar, and aspen, a little cover-up can do wonders. Painted finishes give you a rainbow of options to complement your home’s decor. Easy to maintain and repair, they stand up to direct sunlight far better than clear finishes, too.

For an attractive look, though, you’ll need to paint with more finesse than what’s required for walls, ceilings, or siding. For expert help on the subject, we sought out Jeff Jewitt of Cleveland, Ohio, who has authored four books and four videos on painting and finishing. Here, he demonstrates a surefire painting procedure that includes a coat of glaze for an aged look.

“Surface preparation is everything”

This old painters’ adage certainly applies to painting our chimney cupboard project on page 44. Paint telegraphs wood’s surface imperfections, so plan to spend the bulk of your finishing time patching problem areas.

To prepare the wood for paint, sand to 150 grit using separate blocks for flat and contoured areas, as shown *above right*. The primer you’ll apply in the next step fills the sanding scratches. After you sand the flat surfaces, use 150-grit abrasive to lightly round over the sharp edges. (Paint won’t stick to sharp edges, leading to premature wear.) Fill defects with vinyl putty, sand them smooth when dry, and then remove all surface dust using a vacuum or tack rag.

Prime for painting

Jeff matches his choice of primer to the surface he’ll paint. (See chart at right.) For our pine cupboard, he’s using pigmented shellac primer because it excels at sealing pine’s resinous knots.

With a synthetic- or natural-bristle brush, apply one coat on the surfaces and edges. Apply two coats, spaced 5–10 minutes apart, on the end grain. To save time while painting the doors, Jeff uses a board with exposed nail points, as shown at *right*, to support the wet side while applying primer to the opposite side and edges.

After the primer dries overnight, sand the large, flat faces using 220-grit abrasive on a random-orbit sander or a hand block. Hand-sand the smaller areas, and use a sanding sponge or profile block on routed profiles. Use a light, as shown on page 52, to spot any flaws in the primed surface.

Unlike the sealer coat of a clear finish, it’s okay if you accidentally sand through the

MATCH YOUR SANDING TOOLS TO THE SURFACE





Sanding profile blocks conform to routed contours and reach into tight spaces.



Foam sanding pads and sandpaper-wrapped blocks reach into corners.

a primer on paint primers

	Primer	Best Use	Comments	Dry Time
Water-based acrylic		Use on all new wood, except for pine and other knotty or resinous woods. Use under water-based acrylic paints.	Advantages include low odor, fast drying, and easy sanding with less clogging of abrasives. The water raises grain more than the two other types of primers. May not adhere well to sealed or stripped surfaces. Apply using a synthetic-bristle brush.	Dries to touch within 1 hour; a topcoat may be applied within 4 hours.
Oil-based (alkyd)		Suitable for new wood, oil-based primer penetrates deeper than latex primer to seal lightly weathered wood. Spot priming seals knots in pine.	Use beneath oil-based paint. Check the label to see if it seals in smoke damage or surface marks that might bleed through an unprimed painted finish. Apply using a natural-bristle or all-purpose brush.	Dries to touch in 45 minutes; topcoat after 8 hours (longer in cool weather and high humidity).
Pigmented shellac		Seals knotty or resinous woods that might bleed through latex and some oil-based primers. For refinishing, shellac also seals stripped wood surfaces where residue from the stripping process may interfere with the new painted finish.	Shellac’s alcohol base dries within minutes, and the odor can be less objectionable than oil-based primers. Shellac can be used beneath both oil- and water-based paints. Apply using a natural-bristle or all-purpose brush.	Dries to touch in 15 minutes; recoat after 45 minutes.

NAIL BOARDS SPEED THE PRIMING PROCESS



A nail board supports the freshly primed door of the chimney cupboard, allowing both sides and all four edges to be finished at once. With their fine points, drywall nails provide even support with only imperceptible marring.

primer to bare wood. Just reprime, let it dry, and sand until smooth. Then wipe the surface clean with a tack cloth.

Apply vinyl putty to fill any cavities that need it, as shown *below right*, and then sand the patches flat. Apply one more coat of primer, and sand it with 220-grit abrasive. Sanding the primer and putty creates a lot of dust, so vacuum the surface before wiping it with a damp rag (for latex paint) or a tack cloth (for oil-based paint).

Jeff's 6 success tips for handling a paintbrush

1 Never start the newly loaded brush in a corner or paint will pool there. When working on a flat surface, start 3" from an edge and pull the brush toward the edge to avoid drips. Then come back to where you started, and complete the stroke.

2 If paint pools in corners or crevices, use a brush emptied of paint to collect the surplus.

3 Brush in long, even strokes. Then lightly drag the tip of your brush over the still-wet surface to level it out.

4 Limit your work to manageable sections where you can maintain a wet edge on your finish before the latex dries enough to form a skin.

5 Keep your worksurface horizontal, even if that means tipping the piece on its sides to apply finish.

6 Two thin coats are better than a single heavy coat, which can run or sag.

SMALL SHADOWS CAN SPELL BIG PROBLEMS



Shining a light parallel with a primed surface creates shadows that signal finish flaws. Sand and reprime these areas as needed.

ATTACH THE BACK LAST FOR EASIER ACCESS



By waiting until after the cupboard is finished, but before attaching the back planks, Jeff has more convenient access to the inside.

PATCH AND PRIME WOOD FLAWS FOR A SMOOTHER PAINTED FINISH



STEP 1

Rough surfaces and knots telegraph through the primer, making them easy to spot and fix with latex putty, shown in Step 1. On molded edges like those in Step 2, Jeff applied putty using an easy-to-find tool: his finger. Recreate crisp profiles in the patched details using a block with sandpaper on two sides, as shown in Step 3.

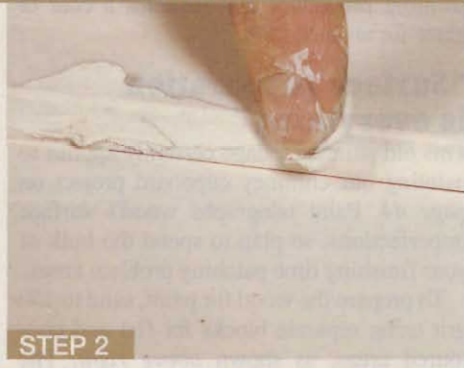

STEP 2



STEP 3

SHOP TIP

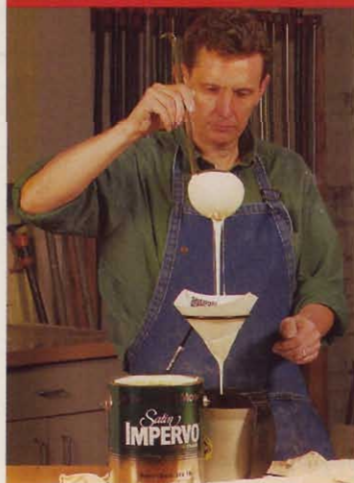

Dip, don't drip

A common kitchen ladle makes a handy tool for transferring paint from a can to a paper cone filter that removes lumps or debris. Ladling the paint instead of pouring it keeps it from collecting in the can rim and preventing a good seal. Transferring paint to a smaller container prevents contaminating the unused finish in the can with brush debris and makes paint easier to carry about.

Pick the right paint

Painting furniture with a typical latex wall paint can produce "block." That happens when objects stick to painted surfaces, such as shelves, because the paint remains soft even after it dries. Instead, use acrylic latex trim enamel for added durability.

For a smooth finish and easier brushing, include an additive such as Floetrol to slow drying time and allow brush marks, like those shown at *right*, to level off.

Jeff usually adds one part Floetrol to 10 parts of paint, equal to about 3 oz. Floetrol per quart of paint. Mix it with the paint in a separate container rather than adding it directly to the original can.



Paint like a pro

Latex paint (See “Pick the right paint” on the *previous page*) requires two types of synthetic-bristle brushes: a 2½” square chisel brush for flat areas and a 1½” angled sash brush for the details, as shown *below*.

Practice your brushstroke on scrap or an unseen area to get a feel for how paint flows out of the bristles. First condition the bristles by dunking them in tap water and wringing

CHOOSE THE CORRECT BRUSH



An angled sash brush reaches into corners and around routed profiles.

out the brush. This helps smooth the finish and makes the brush easier to clean afterward. Next, dip the brush halfway up the bristle length, and tap it against the side of the cup if necessary to remove excess paint.

Jeff holds the brush at a 75° angle to flow the paint onto the surface. Before it can dry, he lightly brushes back and forth to further spread the paint and reduce brush marks.

Sand with 320- or 400-grit sandpaper between the first and second coats. Then remove the dust using your vacuum and a wet rag. Let the second coat dry overnight. Stop here if you want the look of a newly painted surface, or see “Add glaze for instant age in 5 easy steps” for an antiqued look.

Written by **Bob Wilson** and **Jeff Jewitt**

Sources

The following products were used to create the finishes shown here:

Primer: BIN shellac-based primer and sealer, Zinsser Co., 732/469-8100 or zinsser.com

Paint: Waterborne Satin Impervo (#314) acrylic latex enamel in Ivory Tusk (#OC-91), Benjamin Moore & Co., 800/672-4686 or benjaminmoore.com.

Glaze: Glaze Effects water-based glaze in VanDyke Brown, General Finishes, 800/783-6050 or generalfinishes.com. Available from Rockler Woodworking and Hardware, 800/279-4441 or rockler.com, and Klingspor's Woodworking Shop, 800/228-0000 or woodworkingshop.com.

Clear Finish: General Finishes Water-Based Poly/Acrylic Blend in satin. Available from Rockler Woodworking and Hardware and Woodworker's Supply, 800/645-9292 or woodworker.com.

Sandpaper: SandBlaster from 3M, 800/364-3577. Available at most home center stores. An alternative is Royal silicon carbide/aluminum oxide abrasive from Mirka Abrasives, 800/843-3904 or mirka-usa.com.

Floetrol: The Flood Company, 800/321-3444 or flood.com.

Add glaze for instant age in 5 easy steps

To give this cupboard a rustic appearance, add a water-based glaze (see Sources) atop your newly painted surface. Start by lightly smoothing the dried paint with 600-grit sandpaper on the flat surfaces and a gray synthetic abrasive pad on the contours to remove minor blemishes.

Apply the glaze at room temperature, and avoid excess ventilation that might dry it too quickly. If you've never used glaze before, practice spreading it on scrap. Start on the back and inside of the project to get a feel for how much time you have to apply and remove the glaze.

Once applied, give the glaze 24–48 hours to dry. Then protect it with a coat of clear water-based acrylic finish.



STEP 1

Apply the glaze with the same sash brush used to apply the paint. Work the glaze into all the crevices and grooves.



STEP 2

Brush the glaze across the flat surfaces where it will highlight brushstrokes and minor flaws in the painted surface.



STEP 3

Wipe off the excess glaze, and even it out by wiping lightly with a clean, soft cloth. Avoid removing it completely from the flat areas.



STEP 4

Around the moldings and door frame, work the glaze into the contours by lightly whisking a dry brush over the surface.



STEP 5

If you make a mistake or the glaze starts to dry, reactivate it with a mist of water or remove it with a damp cloth. 🌿



In addition to running *Homestead Finishing Products*, a finishing materials supplier and wood dye maker, **Jeff Jewitt** continues to teach and refinish furniture. The latest of his four books, *The Complete Guide to Finishing*, won awards from the *National Association of Home and Workshop Writers*.

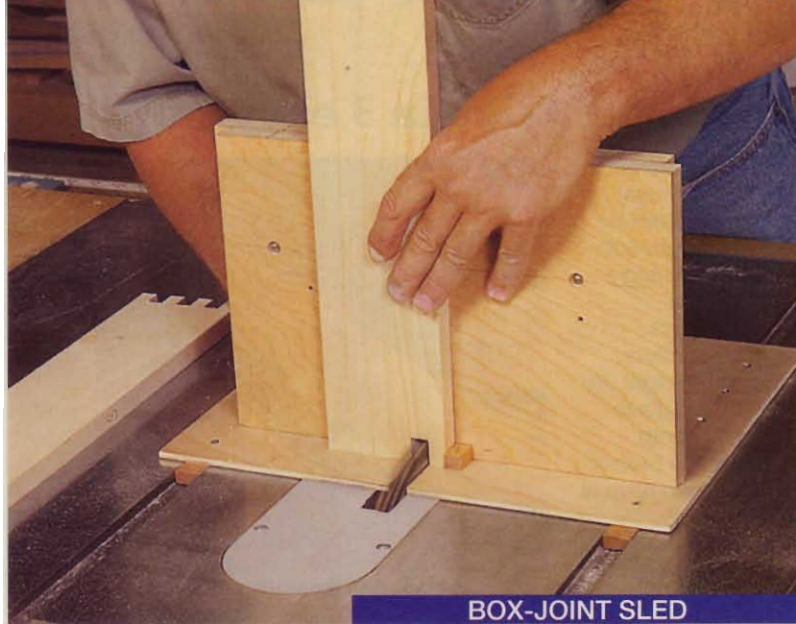

BOX-JOINT SLED



THIN-STRIP RIPPER



TENON-SHOULDER-CUTTING JIG

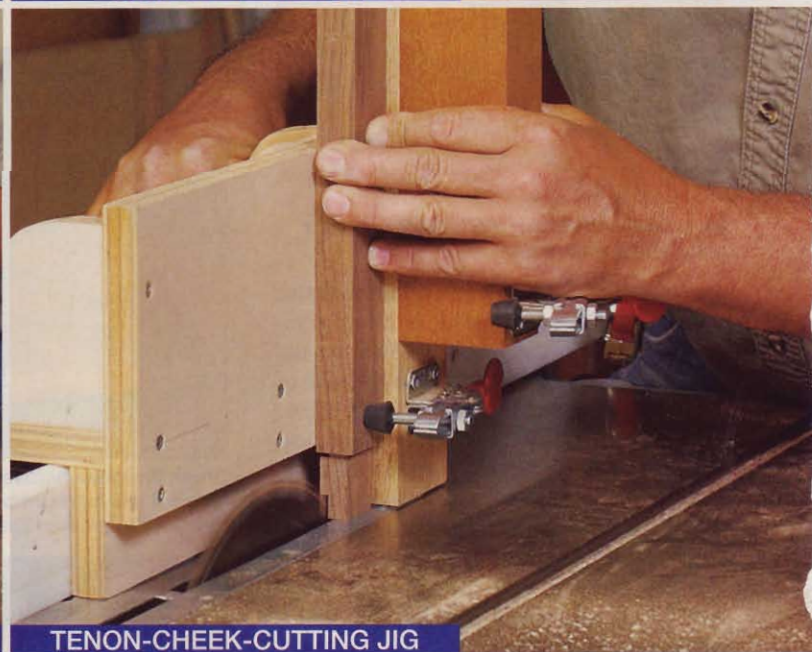

TENON-CHEEK-CUTTING JIG

4 task-tackling tablesaw jigs

Safe, simple, inexpensive, with repeatable precision—these shop-made devices will have you dancing a jig the first time you use them.

There are numerous jigs and upgrade devices available for tablesaws. Many seem overly complex to build or too expensive to buy. But the tablesaw jigs shown here, designed by Zane Powel of Indianapolis, take a different approach, being easy to construct and still easier to use. They include a box-joint sled, a thin-strip ripper, and a complementary pair of tenon-making jigs. With 15 year's experience as a cabinetmaker and another 11 years as a woodworking instructor, Zane has learned to cut through complexity and get maximum results while minimizing his building time and material cost. Build one or more of Zane's jigs to make your saw work harder.



Craftsman Zane Powel teaches at the Marc Adams School of Woodworking. For details and courses, visit the Web site marcadams.com.

The box-joint sled

Sometimes mistakenly referred to as a finger joint, the box joint features good looks and great strength. A well-made one consists of crisp, interlocking, rectangular fingers that fit snugly together. To achieve this, set-up is critical. Thankfully, Zane's jig provides the adjustment capability you need, regardless of how wide or thick your workpiece. And by merely switching adjustable fences, you can use the basic sled for different size fingers. The overall dimensions of the jig can vary depending on the length and width of your table saw's top, or your available scrap. **Drawing 1** provides recommended sizes. The size of, and the width between, the runners depends on the dimensions and spacing of your saw's miter-gauge slots.

Building the jig

1 Cut the base to size from $\frac{1}{4}$ ", $\frac{1}{2}$ ", or $\frac{3}{4}$ " material. Now cut two miter-gauge runners to the height and width of your slots, each at least 14" long. Test the fit in the slots, avoiding any play. Use your saw fence to square the sled base, locating the saw blade at the center of the base. Now, with the runners extending 2" beyond the front edge of the base, and with the base resting flat on the saw top, attach the runners. "I like to use an 18-gauge brad nailer and $\frac{5}{8}$ " nails to temporarily pin the base to the runners to make sure everything remains square," says Zane. "Then I drive $\frac{1}{2}$ " wood screws through the $\frac{1}{4}$ " base and into the runners for strength."

2 Cut two fences to size – one a fixed fence, the other an adjustable one. Zane cautions, "The fences need to be rigid, so I use $\frac{3}{4}$ " birch plywood." Drill and cut out the $\frac{1}{4} \times 1$ " slots in the fixed fence where shown. Attach this fence perpendicular to the base, spacing it 2" behind the front edge. "I glue,

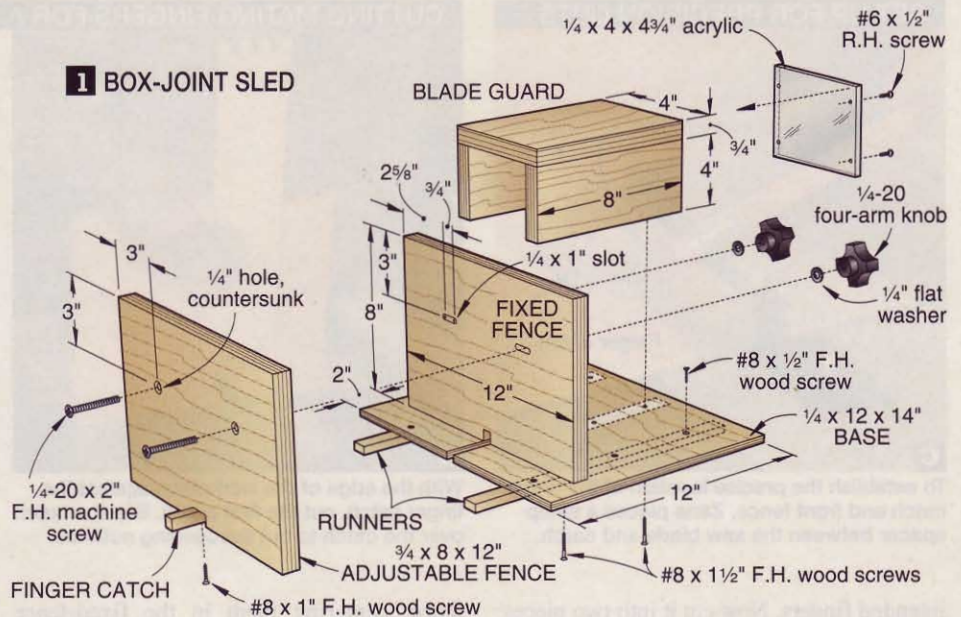

staple, and screw the fence to the sled base," says Zane. "I don't want this assembly to move at all."

3 Next, for safety, and fixed-fence support, add a blade guard to the sled. Begin by cutting the parts to size, and assemble it as shown using glue and screws. Now, screw the blade guard to the base, making sure it fits snugly against the fixed fence. Then, close up the back of the blade guard. Says Zane, "I use a piece of $4 \times 4 \frac{3}{4}$ " acrylic for two reasons: I like to be able to look inside to see if I have unwanted chunks of wood that can bind the dado blade, and I am much less prone to cut through the acrylic back plate. For me, this reminder makes the jig an even safer tool." (See **Photo A**.)

Completing the sled for dead-on box joints

To finish the sled, install your dado blade in the saw, and set it to the width of the fingers that you intend to cut. Raise the top of the blade $\frac{1}{2}$ " above the sled base. Make a single pass to create the initial kerf in the fixed fence. To avoid cutting through the back of the blade guard, Zane offers a safety tip: "Insert and clamp stops into the miter slots to limit sled travel."

Clamp the adjustable fence to the fixed fence, with the bottom edge and ends flush to the sled base. Now make another pass with the dado blade to create an opening equal to the desired finger width. Cut a 4"-long, $\frac{1}{2}$ "-thick piece of wood to the exact width of the

A BLADE GUARD WITH A VIEW

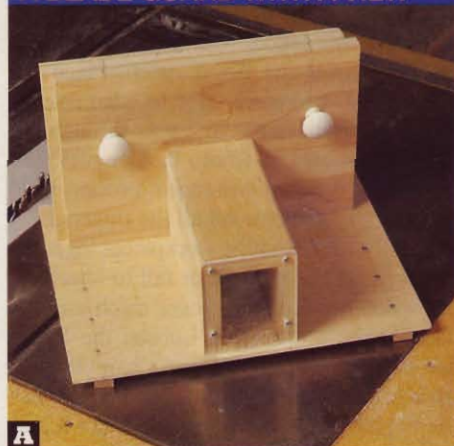

A An acrylic back to the blade guard reminds Zane not to saw through the jig. Four screws hold the piece in place.

MAKE A FACE FOR EVERY FINGER



B Zane makes several easy-to-add front faces for different size box-joint fingers. These attach with machine screws, washers, and knobs.

SET UP FOR PRECISION CUTS

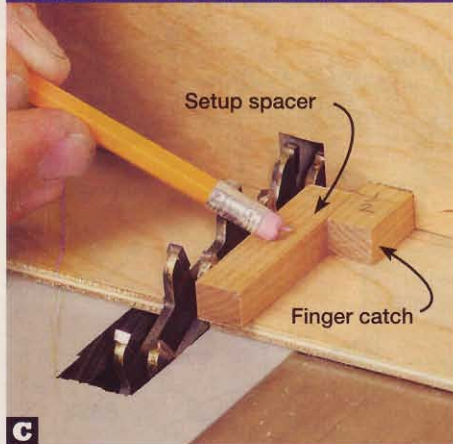

C To establish the precise location of the finger catch and front fence, Zane places a setup spacer between the saw blade and catch.

CUTTING MATING FINGERS FOR A SNUG-FITTING JOINT

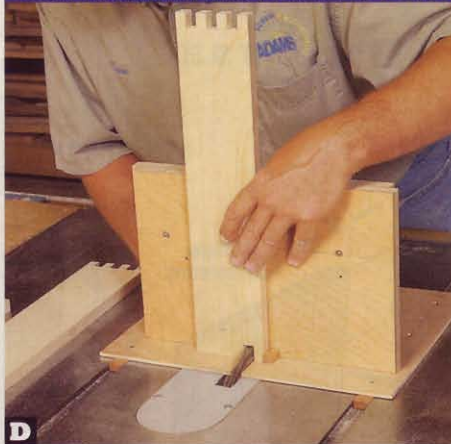

D With the edge of the workpiece against the finger catch, cut the first notch. Slip the notch over the catch to cut succeeding notches.



E Use the notched first workpiece, as shown, to establish the location of the beginning (open) notch to be cut in the mating workpiece.

intended fingers. Now cut it into two pieces: one 1½" long; the other, 2½" long. Use the shorter piece for the finger catch on the adjustable fence. The longer piece will be your setup spacer when positioning the adjustable fence on the sled. Glue and screw the finger catch into the opening on the adjustable fence, flush with the back face. *Note: Zane recommends making an adjustable front fence for each finger width you want to make the jig more versatile, as shown in Photo B on page 55.*

To position the adjustable fence accurately, first place it against the fixed fence, and slide the sled forward until the dado blade is next to the finger catch. Place the setup spacer between the blade and the finger catch. Now clamp the adjustable fence to the fixed fence, and drill two ¼" holes through the adjustable

fence, centering them in the fixed-fence slots. Finally, insert the machine screws through the holes and slots, adding the washers and knobs. (Zane used drawer pulls he had lying around the shop. We used better-suited four-arm knobs in the drawing.) Make a cut through the adjustable fence and check it, as Zane does in Photo C.

Let's cut some box-joint fingers

The length of box-joint fingers equals the thickness of the mating sides. Adjust the dado-blade height accordingly. (See also *More Secrets for Box-Joint Success, below.*) Zane has a great piece of advice when setting up for the actual depth. "Err on the side of making fingers too long. That way, once you glue the joint, you easily can sand the ends

flush because they stand proud of the mating sides. I cut the sides and ends of the box ¼" longer than the plan calls for. Then I set the blade height ⅓₂" higher than the thickness of my boards. After gluing and assembling the joint, I sand away the extra finger length. This results in perfect-fitting joints with glass-smooth faces."

Now test-mill two scraps of wood of the exact thickness. Place the first workpiece (outside face out) on the jig with one edge snug against the finger catch and one end resting on the sled base. According to Zane, "It is absolutely critical that you hold the workpiece firm and motionless." Make your first pass through the saw, as shown in Photo D. Slide the sled back from the blade, reposition the workpiece by slipping the notch you just cut over the finger catch, and make the second cut. Continue cutting notches until you have cut out all the fingers across the entire end of the test workpiece.

To cut the corresponding fingers in the mating test workpiece, flip the first board around so that its front face now rests against the adjustable fence, with the first slot you cut fitted over the finger catch. Place the second test workpiece edge to edge against the first and make the first pass through the blade, as shown in Photo E. Complete the cuts using the step-and-repeat process used earlier until you have cut all the fingers.

Finally, fit the mating workpieces together. If the fingers seem tight or fail to interlock, the space between the finger catch and the dado blade is too wide. Loosen the knobs and slide the adjustable fence a hair closer to the blade. Retighten. If you have play between the fingers, move the adjustable fence a hair away from the blade. Repeat the test until you get a snug fit. Now you're ready to glue up the joint.

More Secrets for Box-Joint Success

- Before cutting the fingers for your project, take a few minutes to lay out how the joints will go together. As the box in Photo B shows, the sides of the box are cut closed, meaning they have a finger on top of each corner of the box. The ends of the box are open, as they start with a slot. Label the top edge of each board, indicating which side goes against the finger catch. Cut both ends of each side first, as they have the same starting point. The fingers on the end pieces are cut last, as they need one of the side pieces positioned over the finger catch to cut the first slot. To alternate the top finger at each corner to give the piece a different look, mark each workpiece clearly so you know whether to cut each end open or closed.

Cut all closed ends first, and then all open ends.

- The artistic aspect of cutting box joints lies in the dimensions and layout of the fingers. The best results are achieved when all the fingers are of equal width. To get these results, select a finger width that evenly divides into the width of the box sides. For example, if the box has 5"-high sides, ½"-wide fingers would mean you will have 10 perfectly spaced fingers at each corner.
- Once you have cut fingers wider or longer than the ones you are cutting now, add a backer between the front face of the adjustable fence and workpiece to preserve the sharp, crisp edges of the fingers. Zane uses scrap ¼"-thick lauan plywood for this.

Super-safe thin-strip ripper

If you have cut multiple thin strips of wood, all to the same thickness, then you know how difficult and dangerous this operation can be. Zane's thin-strip ripper combines the functions of a guide fence and a pushblock to perform this function quickly and safely. Because the jig has only four parts, you can build it in less than an hour. Here's how.

Building the ripper in four easy steps

1 Rip a piece of 5/4 or 6/4 stock to 5" wide and 22" long. You want the ripper wide enough to fit comfortably between the saw fence and the blade without the saw's blade guard interfering with the operation. Adjust the width if necessary. It's important that you cut the jig to an exact whole-inch measurement, to make setting the strip thickness easy. For example, with a 5"-wide jig, you can set the saw fence to exactly 5 1/8" to cut 1/8" strips.

2 Next, crosscut the base extension to size, and then bandsaw stepped notches into one end where shown in **Drawings 4** and **4a**. (The notches make room for the pivoting toggle, and provide a positive stop as you rotate it into the horizontal position to support your workpiece when cutting thin strips.) Note that the pivoting toggle and the maximum width of the notches are both 2 1/4", but the toggle is installed with a 1/8" gap between its end and the end of the notch. Glue and clamp the base extension to the end of the base at this time.

3 Cut the pivoting toggle to size and counterbore a 3/8" hole into the back face of the toggle, 1/4" deep. Drill a shank hole through the part for a #10 panhead screw. Then drill

4 THIN-STRIP RIPPER

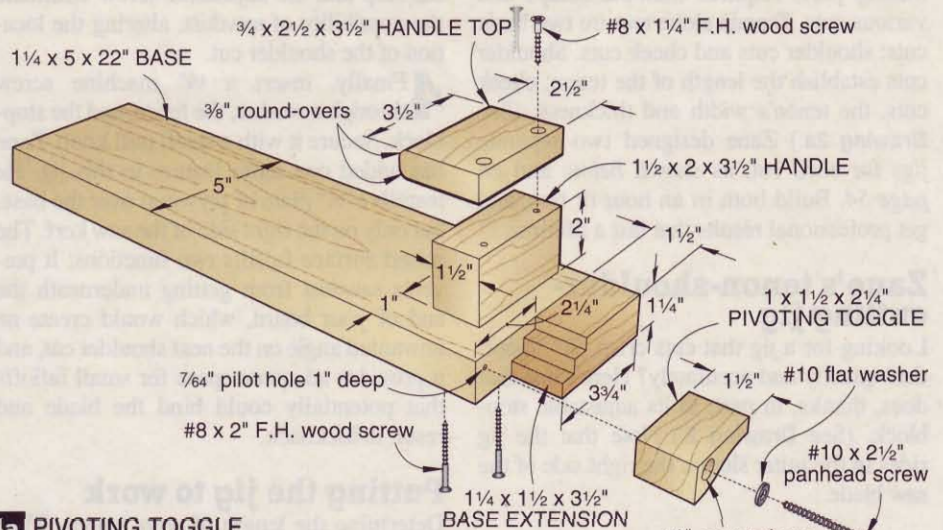

4a PIVOTING TOGGLE

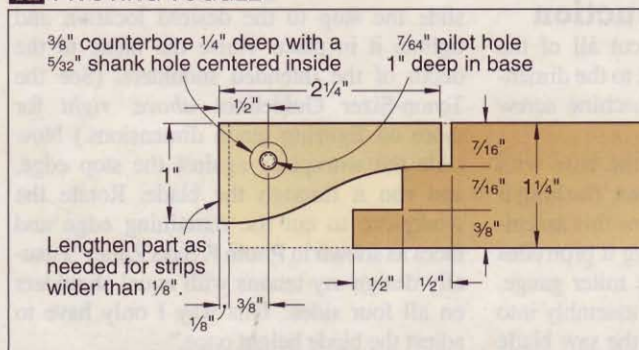

a pilot hole into the end of the base, where shown on **Drawing 4** and **4a**. Screw the pivoting toggle in place so it rotates easily.

4 Mill the two-part handle to the dimensions shown, including the round-over, and glue and screw the parts together. Now, screw the handle assembly to the base. Note:

As a cabinetmaker, Zane often uses his thin-strip ripper to cut loads of edge banding for shelves. For comfort, he contoured the handle of his jig. To ensure a safety margin as you push the jig past the saw blade and guard, leave at least 1" of space between the left end of the handle and the left edge of the main body, as shown **Photo K**.

Let'er rip

Set the saw fence for a width of cut equal to the width of the base plus the thickness of the strips you wish to cut. With the pivoting toggle in the vertical position, place the jig against the fence and slide it forward until the toggle is against the saw table, as shown in **Photo J**. Use the jig as a fence and push the workpiece into the blade to begin cutting the strip. When the trailing edge of the workpiece has passed the toggle, transition the jig from a fence to a pushblock by rotating the toggle into the horizontal position, as shown in **Photo K**. Holding the workpiece flush against the jig, you can now push the entire assembly through the blade to complete the cut and sever off the thin strip.

RIPPING STRIPS IN TWO STEPS



J First use the base of the thin-strip ripper as a fence by sliding the workpiece along its edge after setting up the desired strip width.



K As the cut proceeds, drop down the toggle to serve as a ledge for supporting the workpiece and safely completing the cut.

A trusty pair of tenoning jigs

The mortise-and-tenon joint offers two major advantages: strength and invisibility, making it ideal for furnituremaking. Shaping the mating parts requires multiple setups and various cuts. Tenons alone require two basic cuts: shoulder cuts and cheek cuts. Shoulder cuts establish the length of the tenon; cheek cuts, the tenon's width and thickness. (See **Drawing 2a**.) Zane designed two separate jigs for each cut, as shown *below* and on *page 54*. Build both in an hour or two, and get professional results that last a lifetime.

Zane's tenon-shoulder-cutting jig

Looking for a jig that cuts crisp, 90° shoulders quickly and accurately? Here's one that does, thanks, in part, to its adjustable stopblock. (See **Drawing 2**.) Note that the jig rides in the miter slot on the right side of the saw blade.

Step-by-step construction

1 Referring to **Drawing 2**, cut all of the parts, except the stopblock, to the dimensions shown. Drill the 1/4" machine screw hole in the fence.

2 Next, attach the fence to the base with glue and countersunk screws, flushing it along the base back edge. Screw this assembly to the miter gauge, ensuring it protrudes 1" or more to the right of the miter gauge. Next, set the miter gauge and assembly into the miter-gauge groove, raise the saw blade 1/4" above the jig base, and cut through both the base and the fence. Use the kerf to guide you in centering and installing the blade cover with screws and glue.

3 From 3/4" stock, cut a 6" blank ripped to 1 1/4" wide. With a dado blade, cut the 1/4 x 1 1/2" notch on the bottom edge. Now cut the stopblock to finished length. To form the 1 1/4"-long slot used to adjust the jig when cutting tenons of various lengths, drill 1/4" start holes, where shown, and then scrollsaw

between the holes. Drill a centered pilot hole in the notched end and screw a panhead adjustment screw into the hole. The notch in the stop and the adjustable screw eliminate the possibility of sawdust, altering the location of the shoulder cut.

4 Finally, insert a 1/4" machine screw through a washer, the fence, and the stopblock. Secure it with a small pull knob. Zane has added one more feature to this jig. He installs a 1/4" plate of plywood over the base, but only on the right side of the saw kerf. The raised surface fulfills two functions: It prevents sawdust from getting underneath the end of your board, which would create an unwanted angle on the next shoulder cut, and it provides adequate space for small falloffs that potentially could bind the blade and result in kickback.

Putting the jig to work

Determine the length of your tenons. Then slide the stop to the desired location and tighten it in place. Raise the blade to the depth of the intended shoulders. (See the Tenon-Sizer Guidelines *above*, *right* for more on figuring tenon dimensions.) Now slide the workpiece against the stop edge, and run it through the blade. Rotate the workpiece to cut the remaining edge and faces as shown in **Photo F**. Says Zane, "I usually design my tenons with equal shoulders on all four sides. This way I only have to adjust the blade height once."

"One final thought, when cutting the shoulders, you don't need to push the jig all the way through the saw blade. Once the top of the blade reaches the fence, the shoulder cut is complete."

Tenon-Sizer Guidelines

When the time comes to figure the tenon size, keep in mind the thickness of the wood you're working with, the widths of the chisels and drill bits you own, and the purpose for which you are using a mortise-and-tenon joint. Consider the basics:

- Apply the rule of thirds. For 3/4" stock, that means making a 1/4"-thick tenon with 1/4" shoulders along each side.
- Regarding tenon width, make top and bottom shoulders the same depth as the side shoulders. (Doing this lets you cut all four shoulders using the same saw setup.)
- For full strength, make tenon lengths as long as two-thirds the width of the mating mortised workpiece. Err on the side of creating more gluing surface. The longer the tenon, the stronger. Application is your best guide. In a small picture frame, a short "stub" tenon may suffice; where racking may occur, as in a table leg/apron joint, opt for the "deeper" tenon prescribed above.

SAWING SAME-DEPTH SHOULDERS



F Raise the blade to the establish the needed tenon depth. Then, using the jig, cut shoulders on the workpiece faces and edges.

2 TENON-SHOULDER-CUTTING JIG

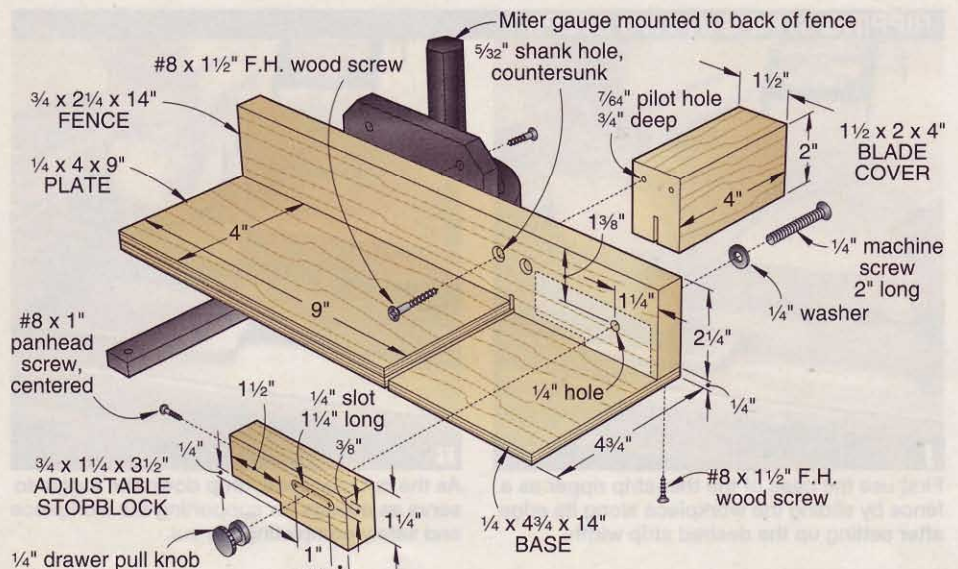

2a MORTISE-AND-TENON JOINT

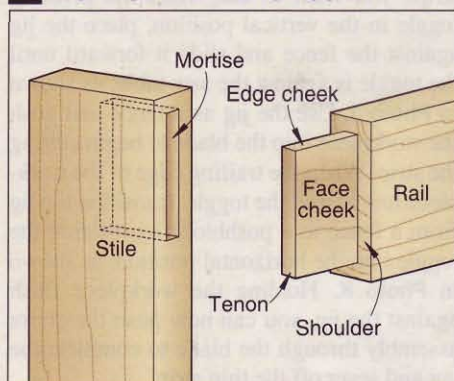

Tenon-cheek-cutting jig

One of the trickiest (and potentially most dangerous) operations on the tablesaw is making cuts into the end of a board stood vertically. The typical tablesaw fence stands too low to provide adequate support when holding the workpiece this way. That's why many woodworkers bandsaw these delicate cuts, and try to sand the cut tenons to perfection, or spend more than \$100 to buy a commercial tablesaw tenoning jig. But Zane's tenon-cheek-cutting jig provides absolute accuracy and safety for the cost of two toggle clamps (and free stock from your scrap bin).

How to build the jig

This jig rides on both the fence and saw table, as shown in **Photos G and H**. Zane says, "It's absolutely critical that the jig holds the workpiece firmly. Any flexing will ruin your tenons, so I use only $\frac{3}{4}$ " cabinet-grade plywood for the jig's box and fence assembly."

Note: The design shown here is based on a tablesaw fence with parallel sides, such as a Biesmeyer-style fence. If your fence does not have this feature, the basic saddle assembly can be secured to a sliding base mounted on runners that ride in the miter tracks, or a base that slides along the fence.

1 Using **Drawing 3**, cut the sides of the saddle to the exact height of your tablesaw fence. Cut the top of the saddle to span both sides when they sit flush against the fence. Glue and screw the top to the sides, ensuring perfect alignment.

2 Cut this jig's fence and braces to size, and then glue and screw them to the base. (The clearance area makes room for the waste while avoiding binding and kickback problems.) Zane advises, "Don't skimp on screws. This assembly needs to be rigid and dead true."

3 Finally, cut and glue up the parts for the vertical workpiece support. It accommo-

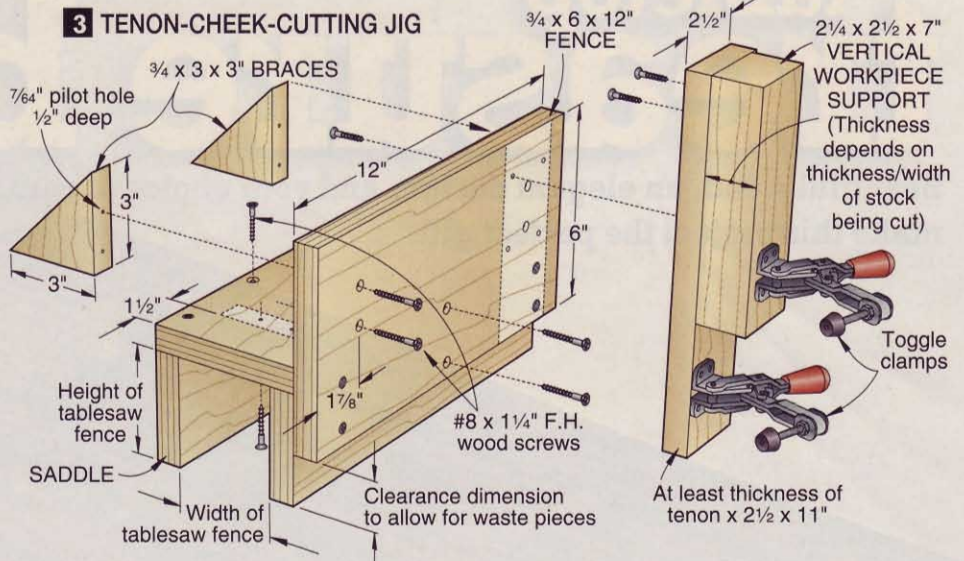

dates boards of varying widths. The first (inside) piece is $\frac{3}{4}$ " thick, the second $2\frac{1}{4}$ ". Note that these dimensions may vary, depending on the dimensions of the stock cut. Glue them together, leaving the thicker piece about 4" shorter than the thinner one. Glue and screw this assembly to the fence and install the low-silhouette toggle clamps. (Find these at woodworking specialty stores or in mail-order catalogs, such as Woodcraft: 800/225-1153, woodcraft.com.)

Now cut dead-on tenons

Set up the jig by adjusting the saw fence to cut the inside cheek of the workpiece. If you have shoulders of equal depth, you will cut all four cheeks without repositioning the fence. When cutting the face cheeks, be sure to lay the workpiece flush to the fence and secure it with the lower clamp, as shown in **Photo G**. When cutting the edge cheeks, add a spacer board for relatively thin stock and clamp it with the outer clamp (**Photo H**). If

the workpiece is wide enough, the upper clamp will hold it in place without a spacer, as shown in **Photo I**.

When cutting tenons, the first cuts you typically make are the shoulder cuts. As a word of precaution, Zane says, "If you set your blade too high on a shoulder cut, you create a shallow kerf in the tenon that will be totally hidden when the joint is assembled. But if you set the blade too high on the cheek cuts, you will cut a kerf into the finished piece that will be visible where the two pieces of wood are joined." Keep a mortised mating piece on hand to test-fit the tenon while fine-tuning your saw setups. Once you achieve a snug-fitting mortise-and-tenon joint, you're ready to cut all of the tenons of that size needed for your project. Set your jigs aside until the next tenoning assignment. ♣

Written by Roger McEvoy
Photos by Ken Kneringer
Illustrations: Roxanne LeMoine

CUTTING CLEAN, STRAIGHT FACE AND EDGE CHEEKS



G Only if the jig fits snugly over the tablesaw fence and rides smoothly along it will it cut clean, well-proportioned tenon cheeks.

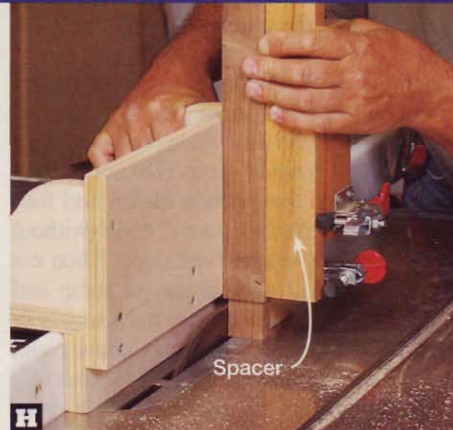

H When cutting edge cheeks, Zane sometimes places a spacer between the opposite edge and outer clamp to achieve a firm hold.



I On wider stock, Zane nixes the spacer and relies on the outer clamp to secure the workpiece when cutting cheeks.

tabletop treasure box

Beautiful wood, an elegant design, and your choice of corner joinery make this project the perfect gift.



A divider made of the same wood species as the lid divides the box interior.

An artful break from regular finger joints, the alternating-width finger joints featured in this design add interest to the corners. You might also consider alternating-width dovetails in place of the finger joints. A small project like this one provides an opportunity to learn how to hand-cut dovetails. See how on *page 64*.

To make it easy to build a box just like the one shown *above* (mahogany box, bocote lid and divider, and wenge handle and feet), we provide a mail-order wood kit. (See **Source**.) You also can use those odd pieces of figured wood you've stashed away. Just pick out contrasting species to set apart the box, lid, and handle. For instance, make the ends and sides from cherry, the lid and divider from maple, and the handle and feet from walnut.

First build the box

1 Plane stock to $\frac{3}{8}$ " thick and cut the ends (A) and sides (B) to the sizes listed on the

Materials List. (We used mahogany.) To make your box with hand-cut dovetail corners, see *page 64*. Then skip to **Step 4** in this section. You also can make your box with alternating-width finger joints that mimic the spacing of the dovetails by following the next two steps.

2 To set up your tablesaw to cut the finger-jointed corners shown on **Drawings 1** and **1a**, first install a $\frac{3}{4}$ " dado blade and cut a test dado in a piece of scrap. (Do not use any shims, just the two outside blades and four $\frac{1}{8}$ " chippers.) Switch to a $\frac{1}{4}$ " dado (without shims) and cut another test dado. Then cut two $\frac{3}{8}$ "-thick, 12"-long pieces of scrap and make spacers by planing one to fit snugly in the $\frac{3}{4}$ " dado, as shown in **Step 1** *above right*, and the other to fit snugly in the $\frac{1}{4}$ " dado.

3 Reinstall the $\frac{1}{4}$ " dado blade in your tablesaw and adjust it to cut $\frac{7}{16}$ " deep. Attach an extension to the miter gauge so it extends about 6" to the right of the blade.

Then pass the extension over the blade, cutting a $\frac{1}{4}$ "-wide notch $\frac{7}{16}$ " deep. Cut a 2"-long pin from the 12"-long $\frac{1}{4}$ " spacer and insert it in the extension notch. Now adhere a stopblock to the extension with double-faced tape, as shown in **Step 2** *above right*, and cut a pair of notches in both ends of the ends (A), as shown in **Step 3**. Next, without changing the depth of cut, switch to a $\frac{3}{4}$ " dado blade and cut notches in both ends of the sides (B), as shown in **Step 4**. Finally adhere a second stopblock to the extension with double-faced tape, as shown in **Step 5**; remove the first stopblock; and cut the center notch in both ends of each end (A), as shown in **Step 6**.

4 To rout stopped grooves in the ends (A) for the bottom (C), where shown on

CUT ALTERNATING-WIDTH FINGER JOINTS IN SIX EASY STEPS

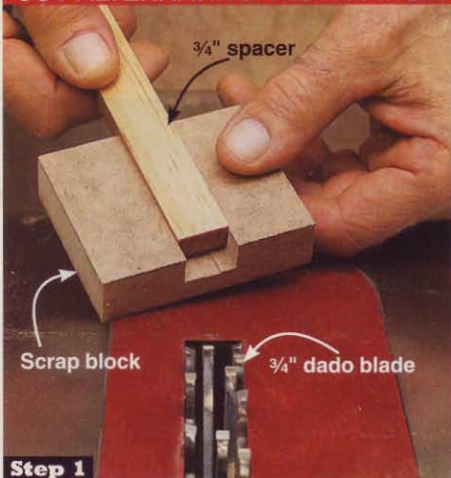

Step 1

After cutting a $\frac{3}{4}$ "-wide dado in a scrap block, plane a $\frac{3}{8}$ "-thick, 12"-long spacer to $\frac{3}{4}$ " wide and test the fit. Repeat with a $\frac{1}{4}$ "-wide dado.

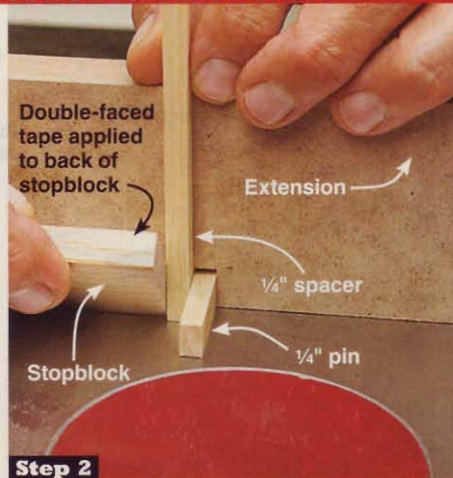

Step 2

Place the $\frac{1}{4}$ " spacer against the $\frac{1}{4}$ " pin in the extension notch. Position a stopblock against the spacer and adhere it to the extension.

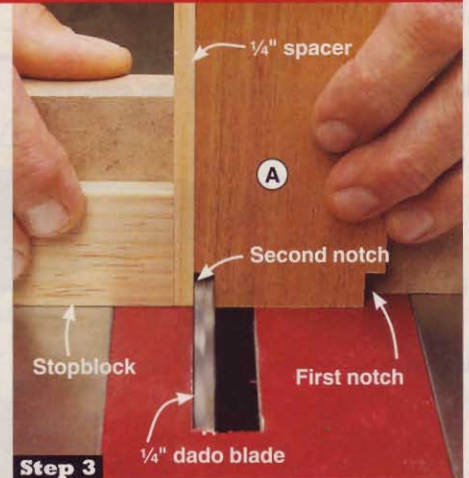

Step 3

Remove the pin. With the $\frac{1}{4}$ " spacer between the end (A) and the stopblock, cut the first notch, rotate the end, and cut the second.

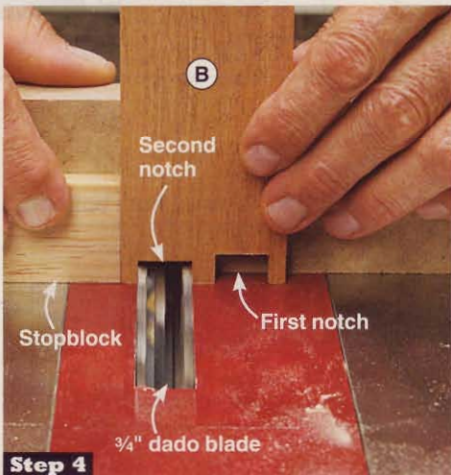

Step 4

Switch to a $\frac{3}{4}$ " dado blade, and with the side (B) directly against the stopblock, cut the first notch, rotate the side, and cut the second.

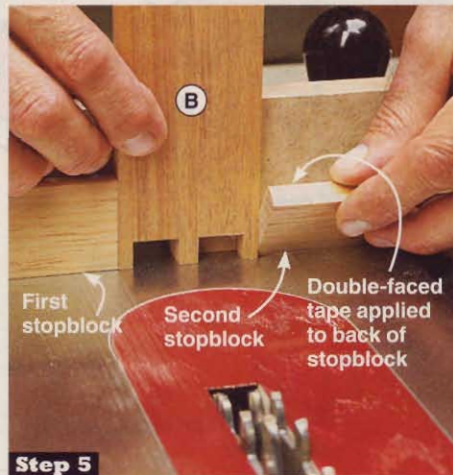

Step 5

With a side (B) against the first stopblock, position a second stopblock against the side, and adhere this stopblock to the extension.

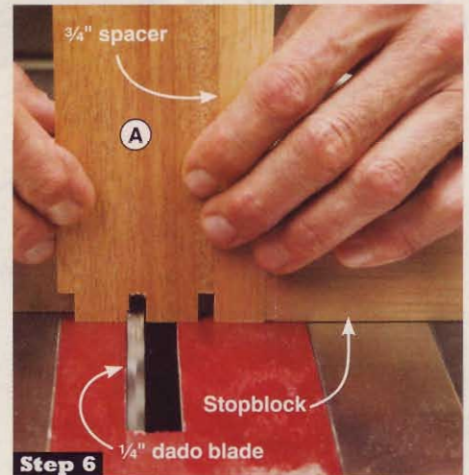

Step 6

Insert the $\frac{3}{4}$ " spacer between the end (A) and the stopblock and cut the center notch in two passes, rotating the side between passes.

Drawing 1, page 62, chuck a $\frac{1}{8}$ " straight bit into your table-mounted router and adjust it to cut $\frac{3}{16}$ " deep. Position the fence $\frac{5}{16}$ " from the bit. Apply masking tape to the fence and mark a groove start line $\frac{1}{4}$ " to the left of the

bit and a groove stop line $\frac{1}{4}$ " to the right. Now adhere scrapwood handles to the outside faces of the ends with double-faced tape, place the bottom edges against the fence, and rout stopped grooves in the inside faces, as

shown in **Photos A and B.** Finally, without changing the setup, rout unstopped grooves in the inside faces of the sides (B).

5 From $\frac{1}{8}$ " Baltic birch plywood, cut the bottom (C) to size and finish-sand it.

ROUT STOPPED GROOVES WITH A SIMPLE SETUP

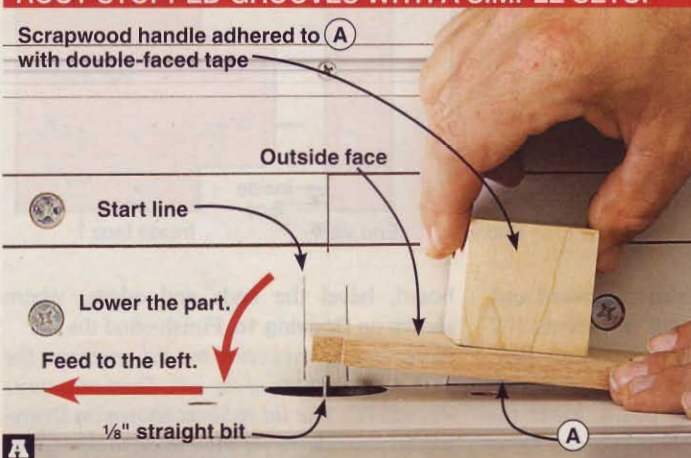

Lift one end of the end (A) to clear the bit and align it with the start line. Then lower the part onto the spinning bit and feed it to the left.

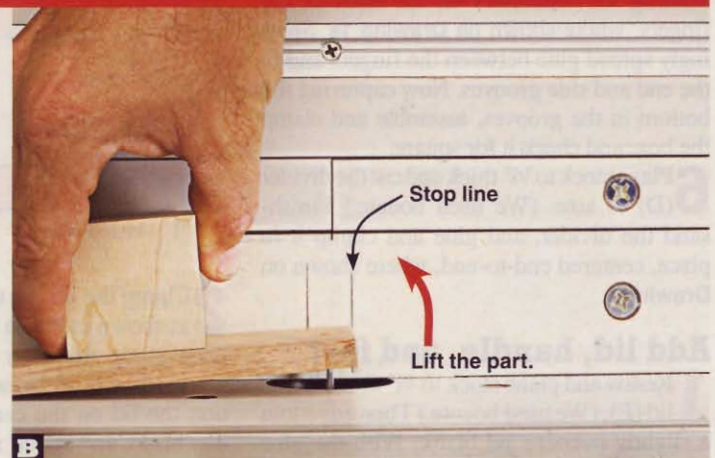

Stop feeding the end (A) to the left when the trailing end aligns with the stop mark. Then lift the end of the part off the bit.

1 EXPLODED VIEW

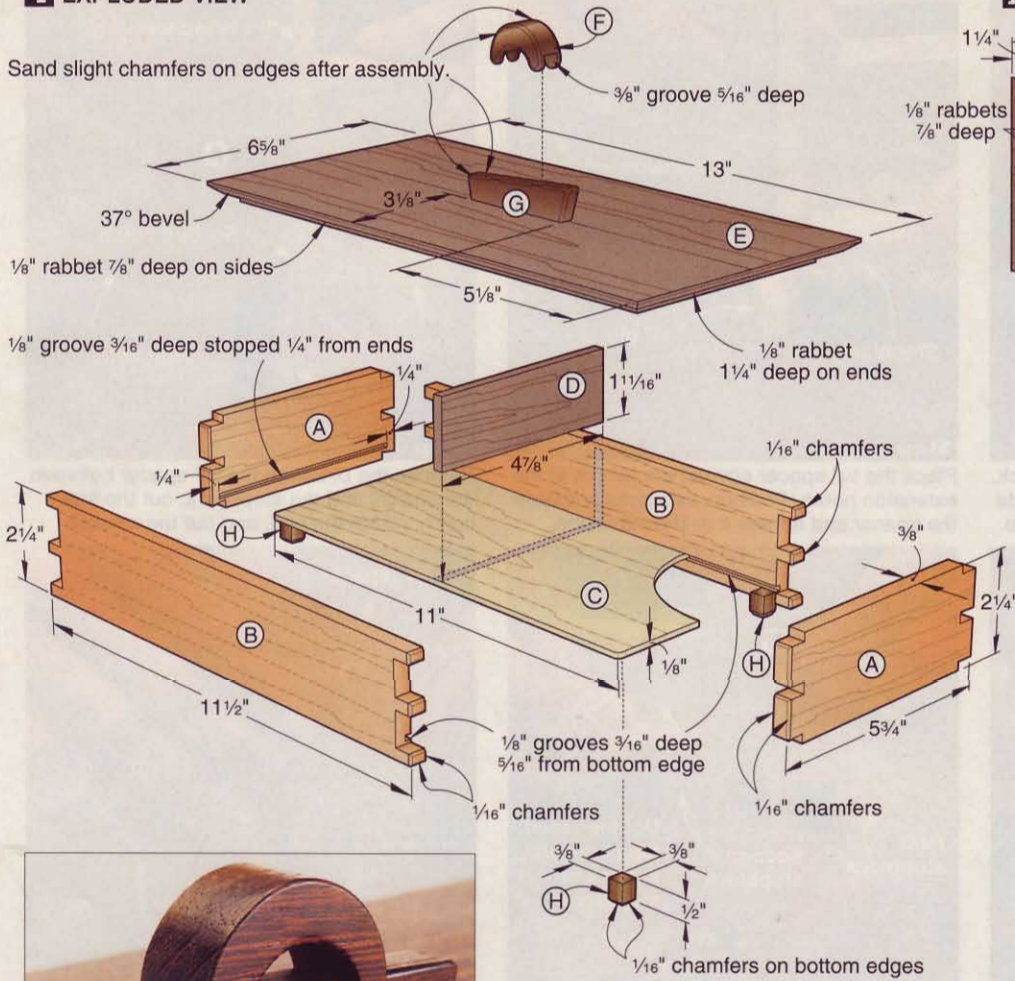

1b LID (Bottom face shown)

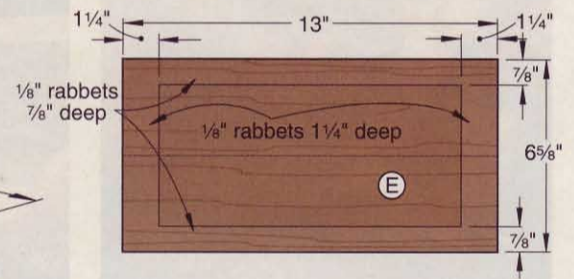

1c LID DETAIL

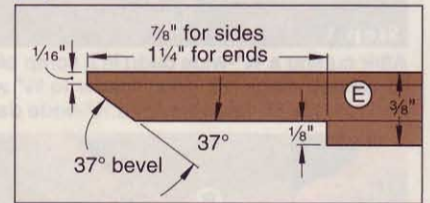

1d FOOT (Viewed from bottom)

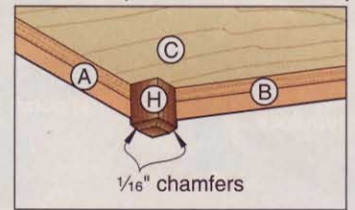

Although it looks complex, the asymmetrical handle gracing the lid is easy to make.

(You also can use 1/8" tempered hardboard.) Then finish-sand the ends (A) and sides (B), sanding 1/16" chamfers on the ends of the fingers, where shown on **Drawing 1a**. Sparingly spread glue between the fingers and in the end and side grooves. Now capturing the bottom in the grooves, assemble and clamp the box, and check it for square.

6 Plane stock to 1/4" thick and cut the divider (D) to size. (We used bocote.) Finish-sand the divider, and glue and clamp it in place, centered end-to-end, where shown on **Drawing 1**.

Add lid, handle, and feet

1 Resaw and plane stock to 3/8" thick for the lid (E). (We used bocote.) Then edge-join a slightly oversize lid blank. With the glue dry, sand the blank smooth and trim it to finished size.

1a FINGER JOINT

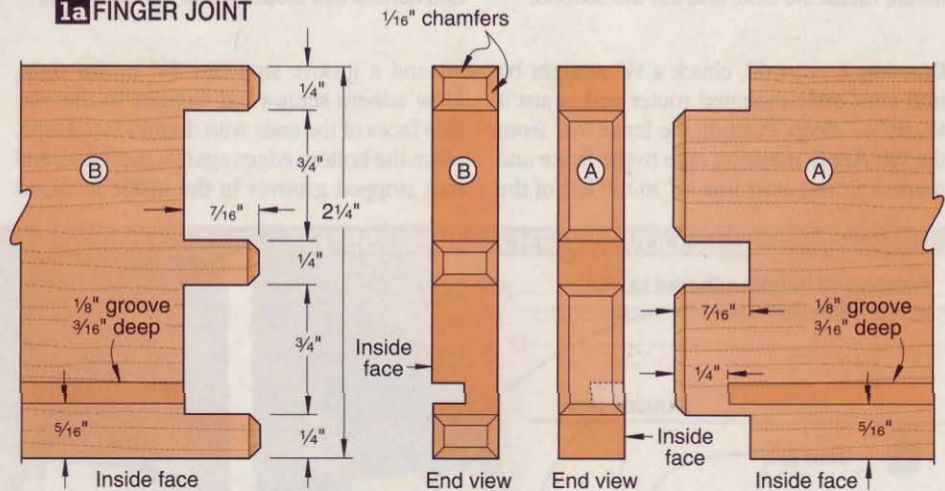

2 Clamp the lid (E) to a carrier board, as shown in **Photo C**, cut 1/8" rabbets 1 1/4" deep along the ends of the bottom face, where shown on **Drawing 1b**. Then reposition the lid on the carrier board, lower the saw blade, and cut 1/8" rabbets 7/8" deep along the lid edges. Now tilt the saw blade to 37 degree and again clamping the lid to the carrier

board, bevel the ends and edges, where shown on **Drawing 1c**. Finish-sand the lid.

Note: Before rabbeting the lid, measure the inside dimensions of the box. Ours measures 4 7/8 x 10 5/8". The lid rabbets shown on **Drawing 1b** provide 1/8" of play in each direction. If your inside dimensions differ, make the necessary adjustments to the lid rabbets.

CUT THE END RABBETS SAFELY



C To steady the lid (E) and keep your fingers away from the blade when cutting the end rabbets, clamp the part to a carrier board.

FORM THE HANDLE LOOP

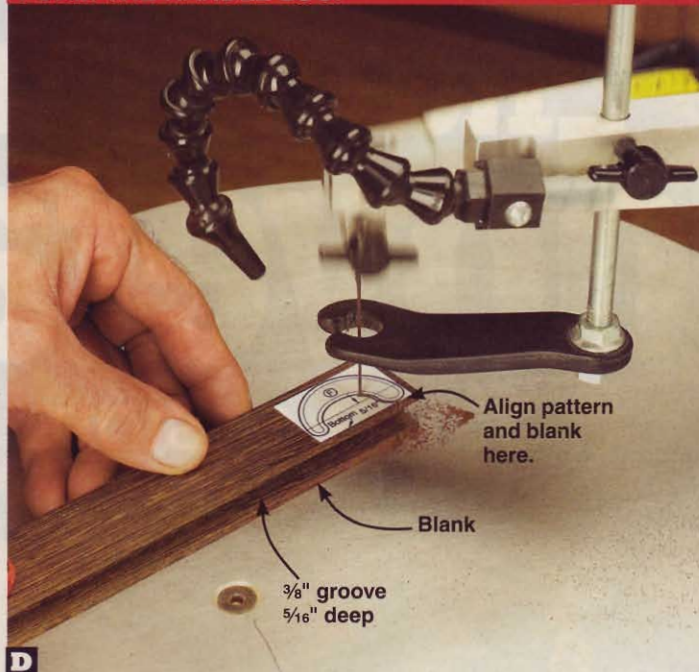

D Adhere the handle loop (F) pattern to the blank, aligning the pattern bottom edge with the blank grooved edge. Scrollsaw the part.

3 Cut a $\frac{3}{8} \times 1\frac{1}{8} \times 12$ " blank for the handle loop (F), handle base (G), and feet (H). (We used wengé.) With a $\frac{3}{8}$ " dado blade in your tablesaw, cut a $\frac{5}{16}$ "-deep groove, centered in one edge of the blank. Then make a photocopy of the handle patterns on the *WOOD Patterns*® insert, and cut them along the rectangular outlines. Using spray adhesive, adhere the handle loop pattern to the side of the blank at one end, and scrollsaw the handle loop to shape, as shown in **Photo D**. Sand the edges smooth.

4 Plane the remaining handle blank to $\frac{3}{8}$ " thick, checking it for a snug fit in the handle loop (F) groove. Adhere the handle base (G) pattern to the blank, aligning the bottom edge of the pattern with the blank edge opposite the groove. Then scrollsaw and sand the handle base to shape.

5 Glue and clamp the handle loop (F) to the handle base (G). Center the loop end-

to-end on the base with the large lobe of the loop at the uphill end, where indicated on the handle base pattern. With the glue dry, sand slight chamfers on all the edges, except for the bottom edges of the base. Then centering the handle (F/G) on the lid (E), glue it in place and secure it with a rubber band.

6 From the $\frac{3}{8}$ "-thick stock remaining from the handle base (G), rip a $\frac{3}{8}$ "-wide strip and crosscut four feet (H) to length. Then

sand $\frac{1}{16}$ " chamfers on the bottom edges and finish-sand the feet. Now glue and clamp the feet into the bottom corners of the box, where shown on **Drawing 1d**.

7 Inspect all the parts and finish-sand where necessary. Apply a clear finish. (We applied three coats of satin lacquer from a spray can, sanding with 320-grit sandpaper between coats.) Now present it to a loved one and enjoy the reaction. ♣

Written by **Jan Svec** with **Jeff Mertz**

Project design: **Steve Altman**, Boonton, N.J.

Illustrations: **Roxanne LeMoine**; **Lorna Johnson**

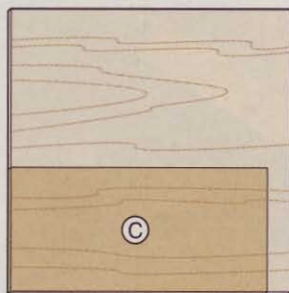

$\frac{1}{8} \times 12 \times 12$ " Baltic birch plywood

Cutting Diagram

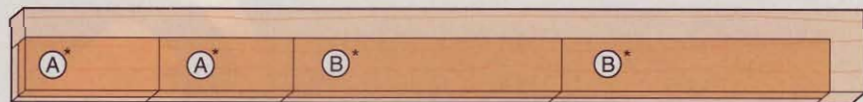

$\frac{3}{4} \times 3\frac{1}{2} \times 36$ " Mahogany (1 bd. ft.) *Plane or resaw to the thicknesses listed in the Materials List.

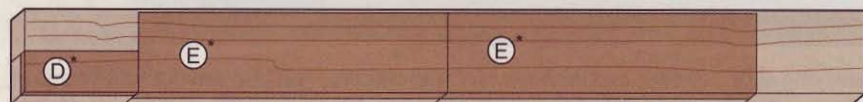

$\frac{3}{4} \times 3\frac{1}{2} \times 36$ " Bocote (1 bd. ft.)

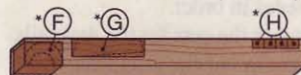

$\frac{3}{4} \times 1\frac{1}{8} \times 12$ " Wengé

Materials List

Box	FINISHED SIZE			Mtl.	Qty.
	T	W	L		
A ends	$\frac{3}{8}$ "	2 $\frac{1}{4}$ "	5 $\frac{3}{4}$ "	M	2
B sides	$\frac{3}{8}$ "	2 $\frac{1}{4}$ "	11 $\frac{1}{2}$ "	M	2
C bottom	$\frac{1}{8}$ "	5 $\frac{1}{4}$ "	11"	BP	1
D divider	$\frac{1}{4}$ "	1 $\frac{1}{16}$ "	4 $\frac{7}{8}$ "	B	1
Lid and handle					
E* lid	$\frac{3}{8}$ "	6 $\frac{3}{8}$ "	13"	EB	1
F* handle loop	$\frac{5}{8}$ "	1"	1 $\frac{5}{8}$ "	W	1
G* handle base	$\frac{3}{8}$ "	$\frac{3}{4}$ "	3 $\frac{1}{8}$ "	W	1
H feet	$\frac{3}{8}$ "	$\frac{3}{8}$ "	$\frac{1}{2}$ "	W	4

*Parts initially cut oversize. See the instructions.

Materials key: M—mahogany, BP—Baltic birch plywood, B—bocote, EB—edge-joined bocote, W—wengé.

Blade and bit: Stack dado set, $\frac{1}{8}$ " straight router bit.

Supplies: Double-faced tape, spray adhesive.

Source

Wood kit. Stock planed to thickness plus plywood for the parts listed above. Kit no. W-168, \$39.95 ppd., five kits for \$169.95 ppd. Heritage Building Specialties, 205 N. Cascade, Fergus Falls, MN 56537. Call 800/524-4184, or go to heritagewood.com.



hand-cut dovetails

for a custom look

Cutting dovetails the old-fashioned way is more than a link to the past. Such well-made joints add a one-of-a-kind handcrafted appearance to your work.

With practice and patience, you can master the satisfying skill of hand-cutting dovetails. If your first attempt isn't perfect, don't worry. Everyone makes kindling-quality practice joints before getting the knack.

Start by gathering the essential tools, shown *opposite top*. Practice on moderately soft wood, such as poplar, and machine your pieces to equal

widths and thicknesses. (With practice, you also can dovetail boards of unequal thicknesses.) Temporarily label the part faces ("front inside" or "side inside") and edges ("top") to keep pieces in order.

We'll cut the pins first, and use those to mark the cuts for the dovetails. But in some situations, it makes more sense to cut the tails first. We'll show you that process, starting on *page 67*.



ESSENTIAL TOOLS

Tools you'll need include a mallet (A), chisels (B), a combination or try square (C), a marking gauge (D), sliding bevel (E), and fine-tooth saw (F). Not shown are a crafts or marking knife, a ruler, and pencils.

1 Set your sliding bevel

Here's a simple way to find the correct angles for the dovetails you'll make. Place a square along the straight edge of a scrap panel and mark a 90° line about 10" long down the center, as illustrated at *right*. Mark that line at 6" and 8" from the edge. Now, place two marks on the edge, 1" from the line on both sides. Draw lines from your 1" marks to the 6" and 8" marks. Set your sliding bevel to the angle of the shorter triangle for softwoods or the longer triangle for hardwoods, as shown in the photo at *far right*.

Traditionally, dovetail angles in softwood are steeper than in hardwood because softwood compresses and slips as the joint is stressed. But the difference is small: an 81° angle (a 1:6 ratio) for softwoods versus 83° (a 1:8 ratio) for hardwoods.

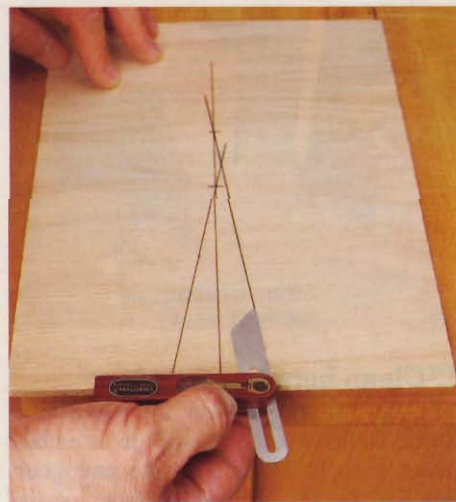
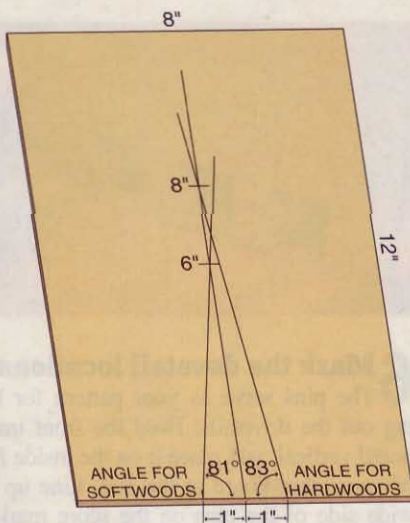

2 Mark your pin cuts

Pins always include the pieces closest to a part's edges and are marked at an angle on the ends, while tails have angled marks on their faces. The number and position of the pins is up to you. For evenly spaced pins, select the number of pins you want between the half-pins on the ends. Divide the space between the half-pins by that number, and then mark the centers of the pins at even distances along the end of the board at the edge of the inside face. After deciding what width you want for the pins at their narrowest point, mark the edge of the board. Avoid making the narrow side of the pins $\frac{1}{4}$ " or smaller; you'll need more working space than that between the tails to be cut later.

Using a marking gauge set to $\frac{1}{64}$ " greater than the thickness of your stock, score a line on both faces and edges of the ends where you'll cut your pins and, later, your dovetails. You'll sand both faces flush after the final assembly. With your sliding bevel set, mark your pins on the end of the board with a crafts knife, as shown at *right top*.

Using a square, score lines from the edges of the pin lines down to the line you scored earlier, as shown at *right bottom*. Shade the scrap areas to be removed.

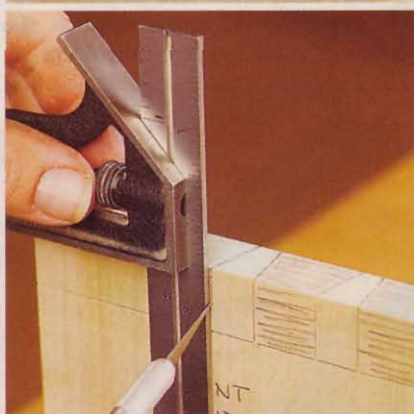
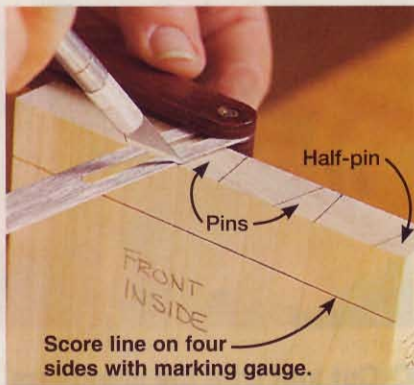

3 Cut the pins

Use a thin-kerf saw, such as the Japanese pull saw shown *below*, to cut along the score lines to the scored marking-gauge lines on both sides. Hold your saw at 90° to the end grain, and cut slowly to prevent the grain of the wood from drawing the saw blade off course. A small square beside your saw can help you maintain a true 90° angle until experience allows you to visualize it unaided.

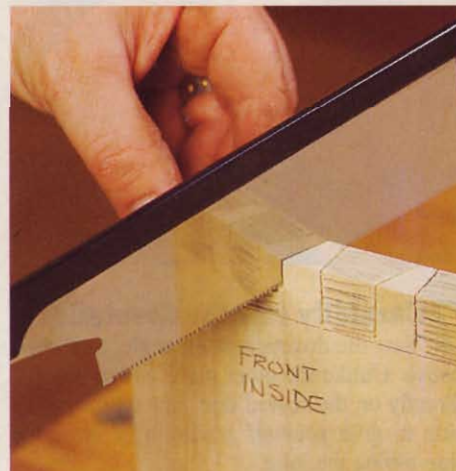

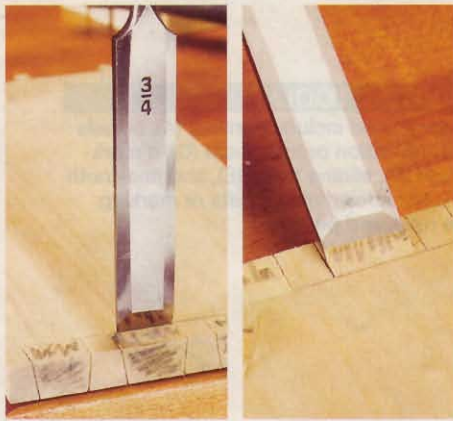

4 Chisel away the waste

Using the widest chisel that will fit between the pins where they're closest together, make shallow stop cuts along the scored line, as shown at *far left*. Don't cut too deep into the wood— $\frac{1}{8}$ " is deep enough for the first pass. Your goal is a clean, straight line. Carefully remove the waste from the end, as shown at *left*, with light taps on the chisel. Make another set of stop cuts, remove the waste, and repeat these two steps until you're about halfway through the thickness of the board. Creating small V-notches helps the waste pop out as you cut between the

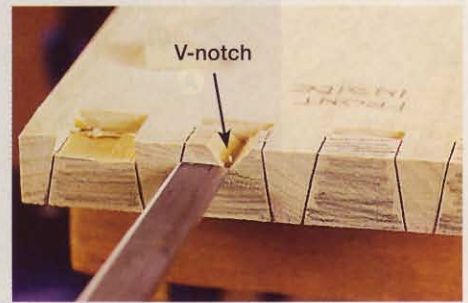

wide faces of the pins, as shown *above*. Flip and reclamp your workpiece to repeat this process on the other face.

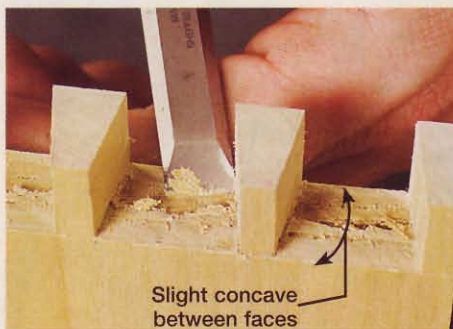

5 Clean between the pins

Clean the area between the pins with a chisel. To make the joint easier to assemble, create a slight concave in the end grain between the pins below the faces of the board, as shown *above*. Your pins are now ready; don't alter them after you begin cutting the dovetails.



6 Mark the dovetail locations

The pins serve as your pattern for laying out the dovetails. Hold the front inside board vertical, and place it on the inside face of your other board at the end. Line up the wide side of the pins on the score mark of



the other board. Mark the dovetails using a crafts knife, as shown *above left*. Once those are clearly scored, use a square and a knife to mark your 90° saw lines along the end of the board, as shown *above right*. Darken the waste areas, if necessary.

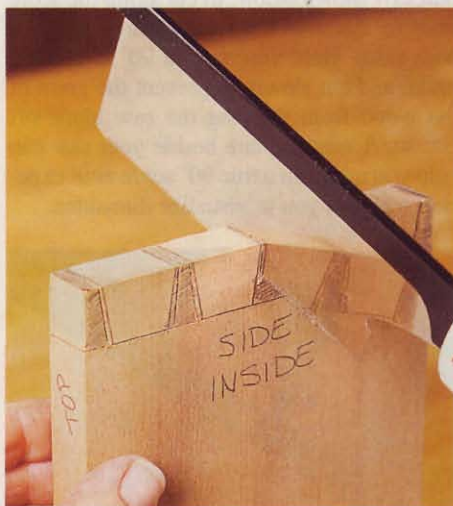

7 Carefully saw the dovetails

Saw the dovetails at an angle, as shown *above*. Unlike the other piece where you cut directly on the scored line, **saw on the waste side to give yourself a margin of error for fine-tuning the joint.**

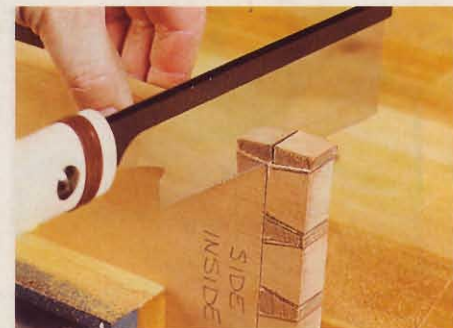

8 Cut and trim the shoulders

Cutting on the waste side, as shown *above left*, saw away the shoulders of the

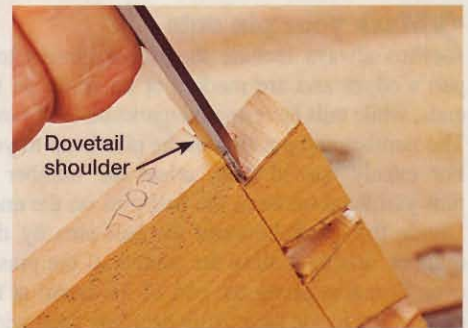

dovetails. Then clean up your work with a chisel, as shown *above*, until the shoulders match the scribed line.

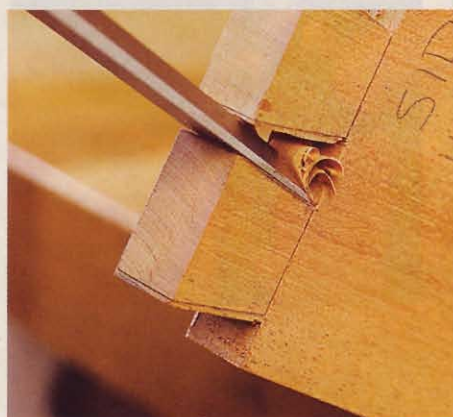

9 Cut between the dovetails

This step resembles cleaning between the pins, except that you'll cut on the waste side up to your score lines to fine-tune the joint. You can see at *left* why we cautioned you against making your pins too narrow at their tips: Narrow pins make it hard to work a chisel between the dovetails.

10 Fine-tune the dovetails

Working slowly and precisely, use your chisel to remove waste almost to the lines you scored with your crafts knife. Begin test-fitting your joint as you work, as shown at *right*. Remove tiny amounts of waste from

the dovetail with each fitting until the joint squeezes together with light mallet taps. Avoid altering the pins. This can be time-consuming until you gain experience, but it makes the difference between a joint you'll admire and one you'll patch.



When making the keepsake box shown *above* and featured on *page 60*, you'll want to reverse the procedure shown earlier and cut the tails first. Why? You'll likely have too little space between the tails to squeeze in a chisel and clean up your cuts, as shown on **Step 9**. By marking the tails first and sawing to your marks, you eliminate the need to clean up the tails, just as you didn't need to fine-tune the pins when you cut those first.

As explained in the previous section, temporarily mark each of your box parts to

identify the front, back, and left or right sides; the inside surfaces; and the top edges. While preparing your stock, cut a couple of backup parts and save any remaining scraps for practice. You'll use the same tools as before, but a $\frac{1}{8}$ " bevel-edge chisel will help you reach between the tails.

The design of this box calls for the ends of both pieces to extend about $\frac{1}{16}$ " proud of the faces. To do this, set your marking gauge $\frac{1}{16}$ " greater than the thickness of your stock, and score lines on the faces and edges at both ends where you'll cut your pins and tails.

1 Lay out the tail locations

Refer to the tail locations specified in the pattern on the *WOOD Patterns*® insert, and then measure and mark the tails on the ends of your stock using a crafts knife, as shown at *right*. At each mark, use your square to extend the mark across the thickness of the ends. Using a fine-tip pencil, darken your score lines to make them more visible.

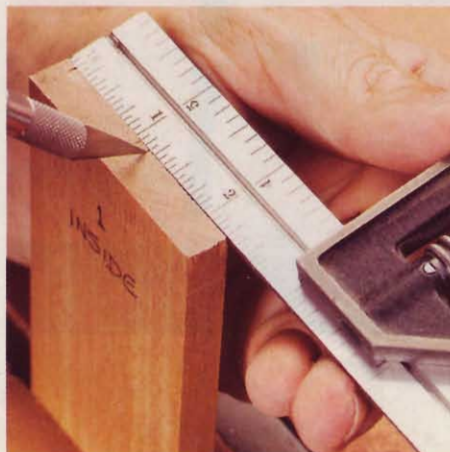

2 Mark angles from the ends

For a precise way to extend your tail lines from the ends down the sides, hold the top of your crafts knife inside the end score line at the edge and lightly push your sliding bevel's metal edge against the knife, as shown *below*. Let the knife tip travel over the end of the workpiece and along the sliding bevel down to your score line. Slightly darken the score lines with a sharp pencil, and mark the waste areas to be removed, if needed.



3 Saw the tails

Rest the tip of your thumb against the smooth blade of your saw for support, as shown *below*, and carefully saw along the angled tail marks down to the score lines on both faces. Note the tight working space; there's less than $\frac{1}{8}$ " between the wide ends of the dovetails. Next, cut on the waste side of your score line to remove the shoulders. You'll remove the rest with your chisel for a clean, precise line.



4 Clean between the tails

Here's where you'll need a $\frac{1}{8}$ " bevel-edge chisel, although you can remove the waste using a $\frac{1}{4}$ " chisel close to the score line and the tip of a crafts knife inserted carefully between the tails to pry loose the waste material. Start with a shallow cut barely $\frac{1}{32}$ " above the score line in the waste area, as shown *below*, and begin removing the waste on each face of the workpiece. Then go back with your chisel and remove the last of the waste down to the score line.

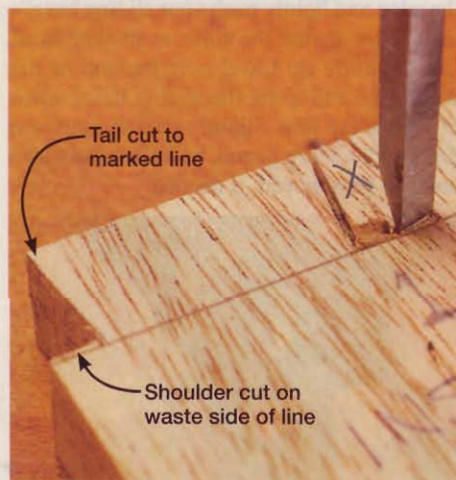

5 Use tails to mark pin cuts

Turn the tail piece so that the inside faces downward. Clamp the pin piece in a vise so the inside faces the inside of the tail piece, as shown *below*. With the shoulder resting along the inside face of the pin piece and the two boards aligned along their edges, score the locations of the pins on the end of the pin workpiece. Light cuts with the crafts knife can be darkened with a pencil.

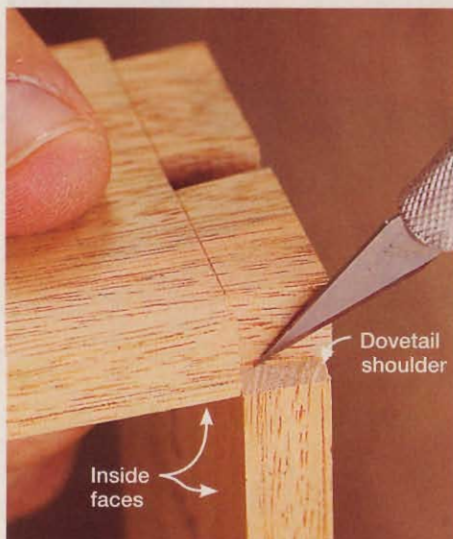

6 Mark the pin locations

Hold the tip of your crafts knife at the edge of your end grain score marks and slide your square against the knife, as shown *below*. Then extend the pin lines down to the scored line. Repeat on the other face. If needed, mark the waste areas to be removed.

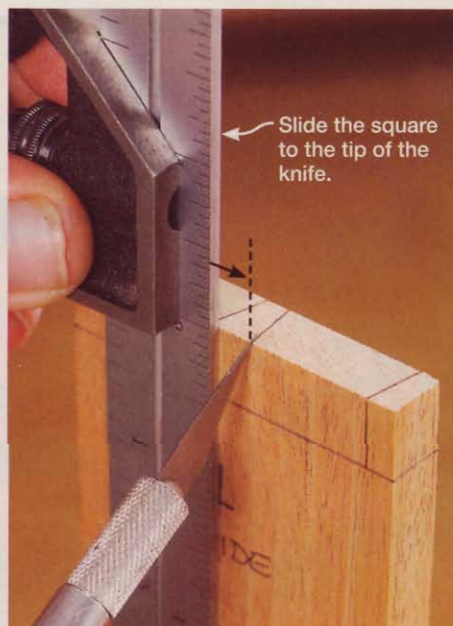

7 Rough-saw the pins

Place your saw blade about $\frac{1}{32}$ " into the waste side of your line and cut to the score line, as shown *below*. Chisel away waste between the pins using the same technique from **Steps 4 and 5** of the previous section. Then use your chisel to shave away the remaining waste on the edges of the pins, bringing them down to your score line as shown in **Step 9** of the previous section. Avoid cutting beyond your score lines.

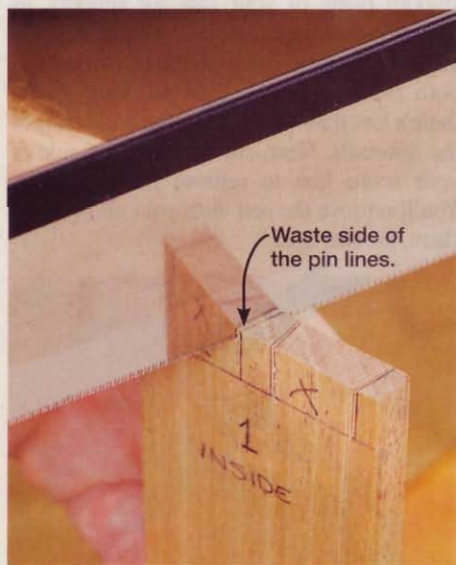

8 Test fit and fine-tune the joint

As you chisel to your marks, periodically test-fit the joint to see which areas mate well, as shown *below*. Trim any pins that need it. The joint should go together with gentle taps from the bottom of the mallet handle. Aim for a joint with consistent wood-to-wood contact between the pieces, not one that has to be hammered together.



9 Bevel the edges and assemble

Once you assemble the joint, use 150-grit sandpaper on a hard sanding block to create a 45° chamfer on the ends of the dovetails and pins, as shown *below*. Sand carefully to create a consistent angle. Then sand the faces, ends, and edges up to 180 grit before gluing and assembling the joints. ♣

Written by Bob Wilson with Jeff Mertz

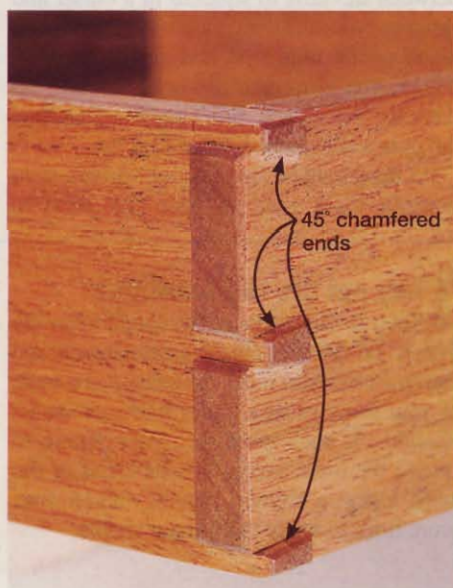



SHOP TESTED

8" jointers

Big and powerful, an 8" jointer may be just the ticket for your shop. Our cutterhead-to-cutterhead test of eight beefy machines compares the performance of straight knives and spiral-style cutters.





Why buy an 8" jointer?

Not every woodworker needs a jointer in the shop—only those who insist on working with stock that is flat, straight, and square. With 6" jointers selling for as little as \$350 these days, you might wonder why you should consider a machine selling for two or three times that much. That's a fair question, and we offer three good reasons to buy an 8" jointer: capacity, capacity, and capacity. Need specifics?

■ **Joint wider stock.** That extra 2" of width may not sound like much, but it makes it possible to face-joint rough-cut lumber (often sold in 6–8" widths), and common widths used in furniture or cabinets, including drawer faces.

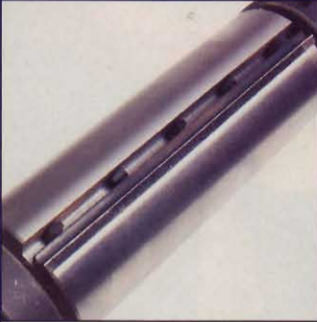
■ **Joint longer stock.** As a rule of thumb, you can joint stock accurately up to about 1½ times as long as the bed (the combination of the infeed and outfeed tables). With an 8" jointer, that amounts to about

COMPARING THE CUTTERHEADS

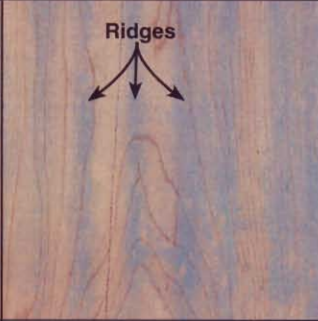
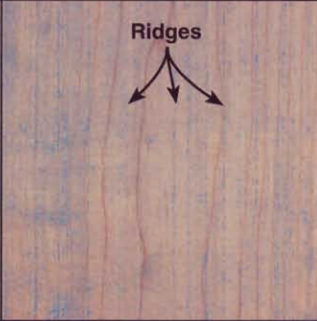
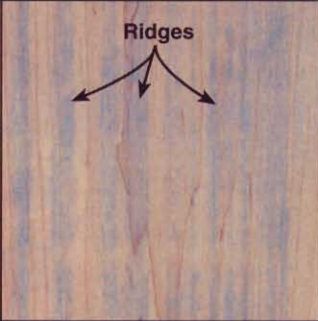
	Straight knives	Helical strip knives	Square inserts	Radiused inserts
Found on:	Craftsman, Delta, Jet, Powermatic	Sunhill	Grizzly, Shop Fox	Yorkcraft
				
Description	The classic jointer cutterhead design: Three long, high-speed steel knives mounted at 120° intervals in the cutterhead.	Three flexible high-speed steel knives become rigid when snugged into the spiral slots around the cutterhead. The spiral design shears the wood, rather than chopping it like straight knives.	Four staggered rows of square cutters arranged in spiral fashion around the cutterhead. Each solid-carbide insert has four sharp edges, which will stay sharp many times longer than high-speed steel.	Similar to square inserts, but the cutting edges are skewed 10°, slightly arched instead of straight, and arranged in six rows. These inserts cut with a shearing effect similar to helical strip knives.
Cut quality				
	Smooth, consistent surface in our tests cutting hard maple, feeding stock at a rate of about 1" per second. Highly figured woods tend to tear out, especially as the knives dull.	In figured woods, we observed little to no tear-out when making a 1/16"-deep cut. Chalking the cut surface of hardwoods revealed wide ridges (the blue stripes) running with the grain.	Narrow, blue-chalked ridges show minor differences in height of individual inserts. Figured woods tear out a bit more than helical strips or radiused inserts, but less than straight knives.	We observed wide-ridge striping similar to that caused by helical strip knives. Tear-out in figured woods is about equal to that of the helical strip knives.
Effect on stock feeding	Feeding too fast can result in cross-grain scalloping.	Because only a small part of the knife contacts the wood at any given time, feeding is easy with little motor strain.	Feed rate requires greater pressure and patience because this style of cutterhead doesn't clear chips as well as others.	Moderate feed pressure required; more than straight or helical strip knives, but less than square inserts.
Bottom line	If you rarely work in figured woods, you'll save money and still get smooth surfaces in hardwoods.	Great for figured woods, and the self-indexing strip knives make knife changes fast. Jointed surfaces require light sanding.	Jointed surfaces require sanding. You'll like replacing only a dinged insert instead of sharpening three knives.	Same convenience as the square inserts, but with a slightly better cut quality. Some sanding still required.

a 9'-long workpiece (compared with a 6' max for the typical 6" jointer). Bigger fences also support stock better when edge-jointing.

■ **Joint with less motor strain.** Manufacturers recommend cutting no deeper than 1/8", so an 8" jointer won't remove any more thickness per pass than a 6" jointer. But even if you never face-joint 8"-wide boards, these big machines cut narrower boards with less stress on the motor, extending its life.

Having said that, we can think of two solid reasons why an 8" jointer might be too much for you:

■ **Tight quarters.** These machines run about 6' long and 24" deep and can quickly eat up a wall in a small shop. That footprint doesn't even include infeed and outfeed room, which adds another 6-7' on both ends.

■ **Tight budget.** Even the least expensive 8" jointers, starting at around \$650, cost more than all but the most expensive 6" machines. The models we tested range in price from \$995 to nearly \$1,400 (a price higher than many woodworkers are willing to spend on a tablesaw!).

Choose your cutterhead: Straight or spiral

Among the eight jointers in our test, we found four different cutterhead styles, shown at *left*. Four tested machines use straight-knife cutterheads—a design as old as the tool itself. The other four jointers use some variation of a “spiral” cutterhead, with knives or inserts arranged in a spiral fashion around the cutterhead.

An increasing number of manufacturers now install spiral-style cutterheads on their jointers—or offer them as an option—because their shearing action produces less grain tear-out in figured wood. Our test results bear that out, as we face-jointed curly white oak, lacewood, and bird’s-eye maple (much to the chagrin of our tester, who nearly wept while jointing these beautiful boards into chips).

We conducted the bulk of our testing, however, in hard maple, and were surprised to find that in that wood we favored the finish left by most straight-knife cutterheads. Face-jointing 8"-wide pieces at a feed rate of about 1" per second, all of the jointers left surfaces that looked acceptably smooth. Not all of them felt smooth, though, and rubbing chalk over the jointed faces revealed ridges—some wide, some narrow—on the spiral-cut samples. (These imperfections sanded away easily.) Meanwhile, chalk on the straight-knife cuts showed consistently smooth and notably scallop-free surfaces.

Manufacturers of the tested spiral-cutterhead jointers weren’t surprised by our findings. Grizzly’s Bill Crofutt explained that a difference of as little as .0005"—that’s half of $\frac{1}{1000}$ "—in the size of an insert (or its pocket in the cutterhead) can create a slightly uneven surface. “Even a layer of machine oil can cause that, so you need to be meticulously clean when installing inserts,” says Crofutt.

Besides jointing figured woods cleaner, spiral-style cutterheads are noticeably quieter in the cut. And, you’ll never sharpen knives or mess with knife-height gauges again: Sunhill’s disposable strip-knives (\$30 for four) and the solid-carbide inserts on the identical Grizzly and Shop Fox cutterheads, and on the Yorkcraft, index to the cutterhead for no-fuss installation.

If you cringe at the thought of downtime due to dull or nicked knives, insert cutters hold their edge longer than high-speed steel knives because they’re made of solid carbide. Also, each insert sports four cutting edges, so you simply rotate it to cut with a fresh edge. Square inserts cost \$2 each to replace, or \$80 to replace all 40 in the Grizzly/Shop Fox cutterhead. Although that’s about twice the cost of three high-speed steel straight knives, you get, essentially, four sets of more durable carbide knives, so square inserts make good economic sense, too. Radiused inserts cost more than \$3 each and there are more of them to replace, so a complete swap of inserts costs close to \$180, making them less of a bargain.

Know the ups and downs of infeed and outfeed tables

All of the tables in our test were within .010" of perfectly flat—well within the acceptable range for an 8" jointer. The infeed and outfeed tables should also be *coplanar* (parallel from end to end as well as front to back); and, again, these machines arrived nearly perfect.

Table heights adjust either by lever or handwheel, as shown in the photos, *top right*. Because matching the height of the outfeed table to the cutter is crucial, we prefer a handwheel adjustment there; levers work fine for infeed table adjustments unless you’re the kind of woodworker who likes to rip stock slightly oversize, and then joint that edge before gluing.

For safety’s sake, we like the fact that Craftsman, Powermatic, and Yorkcraft provide a depth stop that prevents removing more than $\frac{1}{8}$ " of stock, unless you override the stop. (The only good reason to cut deeper is when rabbeting.)

WHEELS OR LEVERS DRIVE TABLES UP & DOWN



Lowering the infeed table increases the amount of material removed with each pass, and the tested jointers use two different systems for adjusting table height. Handwheels, such as the one shown *above* on the Jet infeed table, make fine adjustments easier than levers.

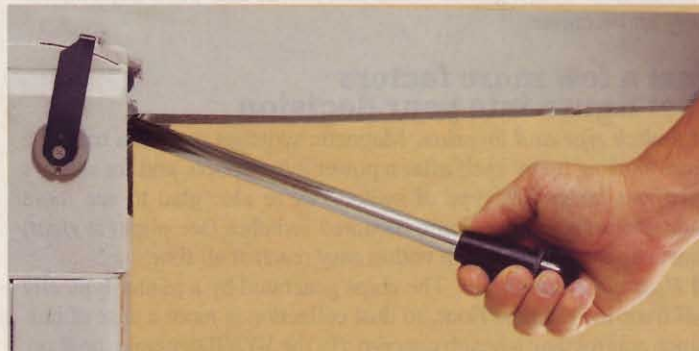

Levers make fast adjustments, usually with less precision, although the levers on the Delta (*above*) and Powermatic tables we tested operated smoothly without the “lurch” we’ve seen in lesser lever-adjusted tables.

RACK & PINION FENCE MAKES A JOINTER BIGGER

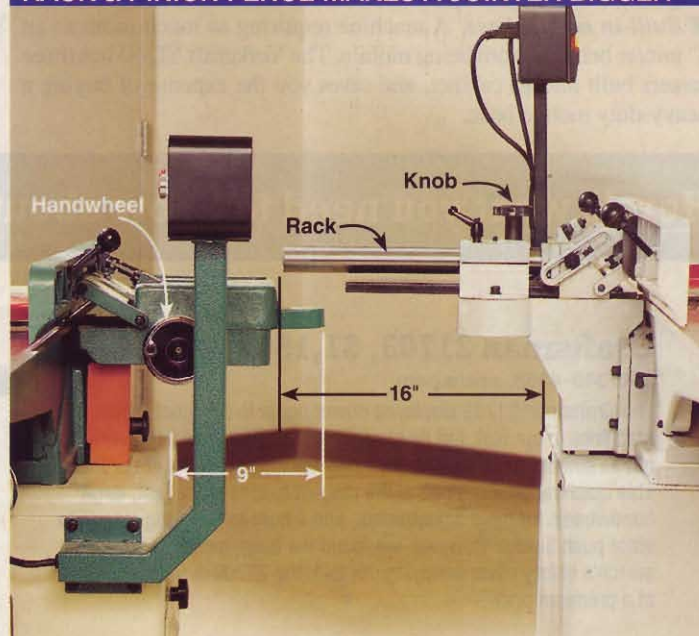

To make a full-width cut on the Yorkcraft jointer (at right, *above*), you’ll need to allow at least 16" behind the machine’s base for the rack. Grizzly’s similar system (left, *above*) requires only 9" behind the base. (6–8" is typical for an 8" jointer without a rack-and-pinion fence.)

Part of your decision hinges on the fence

Once again, we came away impressed with the overall quality of the fences on these machines. All of them measured acceptably flat, locked solidly, and supported stock well, all of which you should expect in a jointer fence. Some manufacturers go above and beyond the basics, though, to make their fences more user-friendly.

For instance, Grizzly and Yorkcraft employ a rack-and-pinion system to mechanically assist with moving those heavy cast-iron fences forward and backward. (See photo, *previous page*.) We found Grizzly's handwheel easier to operate than the smallish plastic knob on the Yorkcraft.

Any cast-iron fence riding directly on a cast-iron table can scratch and damage that table, and Powermatic and Shop Fox prevent this marring with plastic inserts on the bottoms of their fences. Besides protecting the table, these inserts also help the weighty fence to glide more easily.

For making bevel cuts, all of the fences tilt 45° forward and backward with adjustable stops at those angles and at 0° (right angle to the table). Powermatic's bevel system, shown at *top right*, proved best-in-class with a geared crank that makes fine bevel adjustments easy and accurate.

Just a few more factors that figure into your decision

■ **Switch type and location.** Magnetic switches prevent a machine from starting up by itself after a power interruption, and for safety's sake, we prefer this type of switch. We're also glad to see more manufacturers using column-mounted switches (see photo at *right*) that keep the power switch within easy reach at all times.

■ **Dust-collection hood.** The chips generated by a jointer typically fall harmlessly to the floor, so dust collection is more a case of nuisance control than a health concern. (In the *WOOD*® magazine shop, we don't bother with dust collection on our jointer, opting instead to simply scoop up the chips at the end of the day.) Except for the Sun-hill, all of the machines in our test come with a 4" dust-collection port that can be removed from the dust chute if you choose to let the chips fall where they may.

■ **Built-in mobile base.** A machine requiring as much room as an 8" jointer benefits from being mobile. The Yorkcraft YC-8J has three casters built into its cabinet, and saves you the expense of buying a heavy-duty mobile base.

SIMPLE, SMOOTH, AND ACCURATE BEVEL CUTS

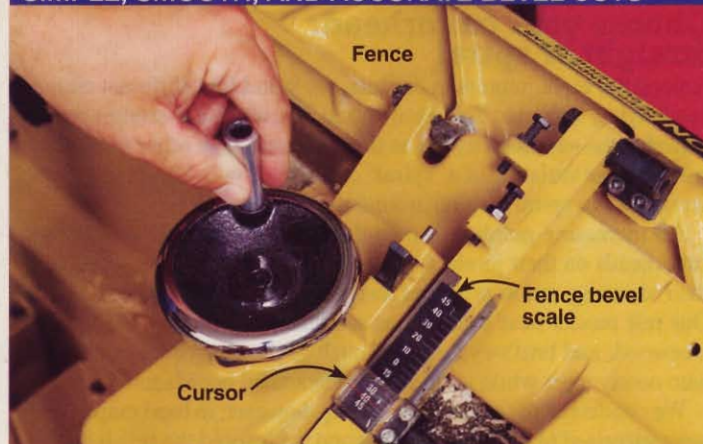

A heavy handwheel precisely dials in the bevel angle on Powermatic's fence, and the large angle scale and hairline cursor make it easy to precisely set the tilt of the fence.

WE LIKE THE SWITCH UP HIGH, JUST IN CASE

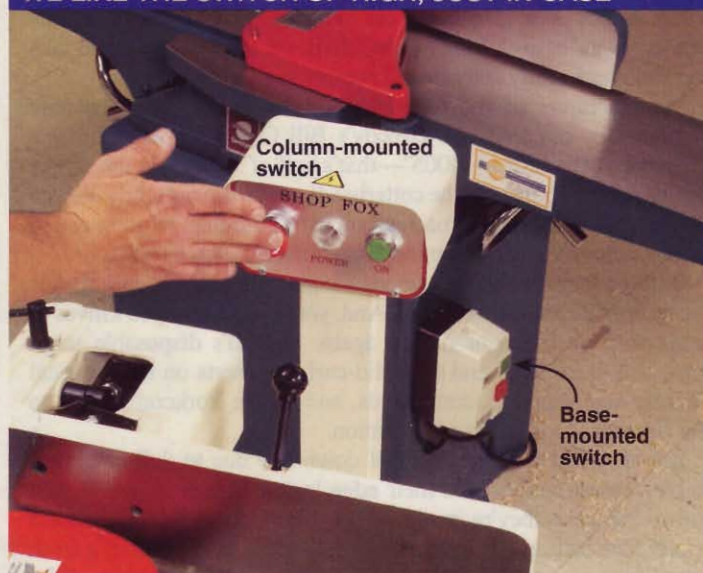

A column-mounted power switch stands tall above the fence for easy access, even in the middle of a cut. Base-mounted switches can be difficult to find and reach before, during, and after the cut.

Here's what you need to know about the biggest machines in the joint

Craftsman 21703, \$1,150

800/349-4358, sears.com

The Craftsman 21703 displayed power equal to the most robust machines in our test, but its straight-knife cutterhead left a surface not as smooth as other straight-knife-equipped jointers in our test. This machine provides one of the longest fences in the test, large handwheels for table adjustments, and a built-in "docking stand" to store push blocks. However, we found the base-mounted power switch's safety cover annoying. All told, the 21703 is a decent jointer at a premium price.



Delta 37-350A, \$1,100

800/438-2486, deltamachinery.com

Excellent cut quality and power make the 37-350A one of the top contenders in our test. Its 43½"-long infeed table provides great support for long boards, while keeping the overall bed length manageable at a little more than 72". The trade-off for this, though, is only about 31" of support on the outfeed end—you'll need a roller stand or other additional support for those same long boards. We'd rather have equal-length tables.

Generally, we prefer the accuracy of handwheels for table-height adjustments, but the 37-350A's infeed table moved smoothly enough to make precise adjustments with its lever. On our wish list for this jointer: a depth-of-cut limiter and magnetic power switch. Both would make the machine safer.



Grizzly G0593, \$995

(also available with straight-knife cutterhead, model G0586, for \$655)
800/523-4777, grizzly.com

The solid carbide square inserts—with four sharp sides on each—in this jointer's spiral cutterhead will go well more than four times as long as high-speed steel straight knives before needing replacement. And you can rotate or replace individual inserts as they dull or become damaged. The square inserts left small ridges (similar to those caused by a nicked straight knife) on the surface. Also, the square inserts cut slower and require more feed pressure than any other style of cutterhead we tested because they don't clear wood chips as well.

We like the G0593's rack-and-pinion system for moving the heavy fence across the table. However, we wish this jointer had a depth-of-cut limiter. If you don't work much with figured woods, Grizzly sells this same jointer with a straight-knife cutterhead for only \$655—a real steal, in our book.



Jet JJ-8CS, \$1,200

800/274-6848, wmhoolgroup.com

We found the handwheel adjustments for the infeed table smooth and precise, and the knives easy to change thanks to this jointer's spring-loaded cutterhead and knife setting gauge. The JJ-8CS also plowed through hardwoods easily and demonstrated cut quality nearly on par with the test-best Powermatic. It matches Powermatic's five-year warranty and price tag, but offers the shortest bed in the test, a base-mounted power switch, and no depth-of-cut limiter. A very good machine, but dollar for dollar, it falls short of the Powermatic.



Powermatic 60B, \$1,200

(stock no. 1610077K)
800/248-0144, powermatic.com

The Powermatic 60B ran away with Top Tool honors in this test. Priced comparably to the Craftsman and Jet jointers, it ranks at the top in many areas: cut quality (from the fastest cutterhead), bed length (83", or nearly 8" longer than the next longest), and weight (its solid 600+ lbs gives this machine great stability, even when working long, heavy stock).

Other pluses on the 60B include the rack-and-pinion fence-tilt system, a plastic fence glide that protects the tabletop, column-mounted magnetic power switch, and a depth-of-cut limiter. We can't even knock the lever system for adjusting infeed-table height, despite our preference for handwheel adjusters; it proved silky smooth and precise in our tests.





Shop Fox W1705, \$1,395

(also available with straight-knife cutterhead, model W1684, for \$1,050)
800/840-8420, shopfox.biz

The W1705 uses the same square-insert cutterhead as the Grizzly G0593, with all of its advantages (durable carbide cutters, little tear-out in figured wood, quiet cut) and disadvantages (ridges, slow cut, more feed pressure required). We like the handwheels for adjusting table height, the column-mounted magnetic power switch, and the plastic glide on the bottom of the heavy, 40"-long fence to protect the table from damage. But other jointers we tested offer the same features for a lower price. If you rarely joint figured wood, you can save more than \$400 by buying the identical W1684 with its straight-knife cutterhead.



Sunhill CT-204L with spiral cutterhead, \$1,000

(also available with straight-knife cutterhead for \$795)
800/929-4321, sunhillmachinery.com

This jointer, with its optional three-knife helical cutterhead, is priced about the same as the Grizzly G0593. The CT-204L doesn't come with a dust-collection port, column-mounted power switch, or push blocks like the other machines, but the helical head rapidly sliced through figured woods with no visible tear-out and with the easiest feed rate of all of the spiral designs. In our hard maple test pieces, the CT-204L's helical knives tended to leave wide, shallow ridges that striped our test samples, but they sanded down easily.

THE STRAIGHT

BRAND	MODEL	MOTOR			
		VOLTAGE (1)	AMPERAGE AT 110V, 220V (2)	TYPE (3)	LOCATION (4)
CRAFTSMAN	21703	220	8.6	M	B
DELTA	37-350A	110/220	16.3, 8.1	N	B
GRIZZLY	G0593	110/220	24, 12	M	C
JET	JJ-8CS	220	12	M	B
POWERMATIC	60B (1610077K)	220	9	M	C
SHOP FOX	W1705	220	12	M	C
SUNHILL	CT-204L (w/spiral)	220	12	M	B
YORKCRAFT	YC-8J	110/220	22, 11	N	C

1. All wired from the factory for 220 volts. All testing conducted at 220 volts.
2. According to manufacturer's specifications.
3. (M) Magnetic
(N) Nonmagnetic
4. (B) Base
(C) Column
5. (H) Helical knives
(RI) Radiused inserts
(SI) Square inserts
(ST) Straight knives
6. (C) Carbide
(S) High-speed steel

When all is said and done, here's where we'd put our money

Insert-style spiral cutterheads have definite advantages over traditional straight-knife cutterheads. Most of the advantages relate to convenience, though, not cut quality. Frankly, unless you frequently joint a lot of figured woods, we're not convinced that today's spiral

cutterheads are worth the extra money: In domestic hardwoods, we found the surface left by most straight-knife cutterheads smoother. That's part of the reason why we named the Powermatic 60B our Top Tool. If your budget (or spouse) can't handle the \$1,200 ticket,

Yorkcraft YC-8J (#2350) with spiral cutterhead (#6200), \$1,050

(also available with straight-knife cutterhead for \$600)
800/235-2100, wilkemachinery.com

The radiused inserts on the spiral cutterhead combine the characteristics of square inserts and helical knives: easy-to-change cutters that leave wide but shallow ridges, which sand away easily. The inserts mount at a skewed angle, clearing chips better and faster than square inserts, so less feed pressure is required. It also directs more chips out the back end of the cutterhead, where they escape the suction of the dust collector.

We like the rack-and-pinion fence mover, but the smallish knob requires more effort than Grizzly's handwheel, and the rack sticks way out the back of the machine on an 8"-wide cut. The YC-8J's built-in mobile base adds at least \$60 in value. Since we completed our tests, the manufacturer has added another jointer in the category with a slightly more powerful motor (item #2351, \$1,100 with spiral head; \$650 with straight knives).



SCOOP ON EIGHT 8" JOINTERS

SWITCH		CUTTERHEAD				TABLE				FENCE		PERFORMANCE GRADES (13)				ACCESSORIES (14)							
KNIFE STYLE (5)	KNIFE MATERIAL (6)	MAXIMUM WIDTH OF CUT (INCHES)	SPEED (RPM) (7)	BED LENGTH (INCHES) (8)	INFEEED TABLE ADJUSTMENT TYPE (9)	OUTFEED TABLE ADJUSTMENT TYPE (9)	MAXIMUM CUTTING DEPTH (INCHES) (10)	DEPTH-OF-CUT LIMITER (YES/NO)	FENCE SIZE (L X H, INCHES)	FRONT-TO-REAR ADJUSTMENT TYPE (11)	TILT ADJUSTMENT TYPE (12)	CUT QUALITY	TABLE ADJUSTMENT EASE	FENCE ADJUSTMENT EASE	BLADE CHANGING EASE	ACCESSIBILITY OF CONTROLS	STANDARD	OPTIONAL	CORD LENGTH (FEET)	WEIGHT (POUNDS)	WARRANTY (YEARS)	COUNTRY OF ASSEMBLY (15)	SELLING PRICE (16)
ST	S	8 1/8	5,181	71	H	H	1/2	Y	40x4 7/8	S	M	B-	A	B	B+	B-	D,K,P		8	420	1	C	\$1,150
ST	S	8 1/8	5,588	72 3/4	L	L	5/8	N	35x5	S	M	A-	A-	B	B	B+	D,P	M	6	394	2	C	\$1,100
SI	C	8	5,782	75 1/8	H	H	1/2	N	38x4	R	M	B-	A	A-	B+	A	D,K,P	M	8 1/2	418	1	C	\$995
ST	S	8 1/8	5,737	62 1/4	H	H	1/2	N	38x4	S	M	A-	A	B	A-	B	D,K,P	M	5 1/2	398	5	T	\$1,200
ST	S	8 1/8	7,169	83 1/8	L	L	1/2	Y	38x4 3/4	S	H	A	A-	A	B	A	D,K,P		5 1/2	610	5	T	\$1,200
SI	C	8	5,692	70 1/2	H	H	1/2	N	40x5	S	M	B-	A	B+	B+	A	D,E,P	M	10	465	2	T	\$1,395
H	S	8 1/8	5,672	73 1/2	H	H	1/2	N	38x4	S	M	B	A	B	B+	B	K		5 1/2	470	1	T	\$1,000
RI	C	8	5,588	72 3/4	L	H	1/2	Y	35x5	R	M	B	A-	A-	B+	A-	D,E,M,P		6	500	1	C	\$1,050

7. Measured by phototachometer under no load.

8. Infeed and outfeed tables are the same length on all models except Delta. The Delta infeed table makes up 43 1/2" of its 72 3/4" total bed length.

9. (H) Handwheel
(L) Lever

10. For rabbeting only. Manufacturers recommend removing no more than 1/8" of material when face- or edge-jointing.

11. (R) Rack-and-pinion gear
(S) Slide-in keyway

12. (H) Handwheel control
(M) Manual tilt

13. **A** Excellent
B Good

14. (D) 4" dust port
(E) Extra inserts
(K) Knife-setting gauge
(M) Mobile base
(P) Push blocks

15. (C) China
(T) Taiwan

16. Prices current at time of article production and do not include shipping where applicable.

Written by Dave Campbell with Jeff Hall

Grizzly's G0586—identical to the G0593 we tested, but with straight knives—comes nicely featured for about half that.

In wild-grained figured woods, the Sunhill CT-204L cut cleanest, but only a bit better than the Yorkcraft YC-8J with spiral cutterhead,

and the prices are about equal as well. However, the Yorkcraft comes with some nice amenities, such as the built-in mobile base, rack-and-pinion fence, push blocks, and a dust hood, making it a better value than the Sunhill. ♣

at-your-side magazine rack/table



Placed beside a sofa or easy chair, this handsome accessory keeps favorite reading materials at hand and provides a place for a beverage, TV remote, lamp, or other objects essential to your relaxation.



As an option, leave off the table and fit the rack with a handle.

Here's a project you can build in a weekend and enjoy every day. With many of the parts shaped identically, you'll find the construction quick and easy. Make it even simpler by omitting the top, as shown in the inset photo *above* and explained in the article on *page 30*.

Start with the ends

1 Edge-join $\frac{3}{4}$ "-thick stock (we used walnut) to form two $12\frac{1}{2} \times 13\frac{1}{2}$ " blanks for the ends (A). Then crosscut and rip the blanks to the finished size of $12\frac{1}{4} \times 13\frac{1}{8}$ ".

2 Mark centerpoints for four mounting holes on the *outside* face of each blank, where dimensioned on **Drawing 1**, where dimensioned on **Drawing 1**. Drill a $\frac{3}{8}$ " counterbore $\frac{3}{8}$ " deep at the centerpoints. Then drill a $\frac{5}{32}$ " shank hole, countersunk, centered inside each counterbore. On each blank, mark the top and draw a centerline along the length on the counterbored face.

3 Make four copies of the full-size end half pattern from the *WOOD Patterns*® insert. Spray-adhere two pattern halves to each blank, aligning their edges and marked centerlines, as shown in **Photo A**.

4 Bandsaw and sand the end blanks to shape, leaving a $1\frac{1}{4}$ "-long flat, centered, at the tops for mounting the posts (H), where shown on the pattern and **Drawings 1** and **2**. Lightly ease the edges of the ends (A) with 150-grit sandpaper. Save the cutoffs to make color- and grain-matched plugs for the counterbores later. If you plan to mount an optional handle in place of the post/top assembly (H/I/J), round the top edge of the ends, as explained in the article on *page 30*. Remove the patterns using a cloth moistened with paint thinner.

1 PARTS VIEW

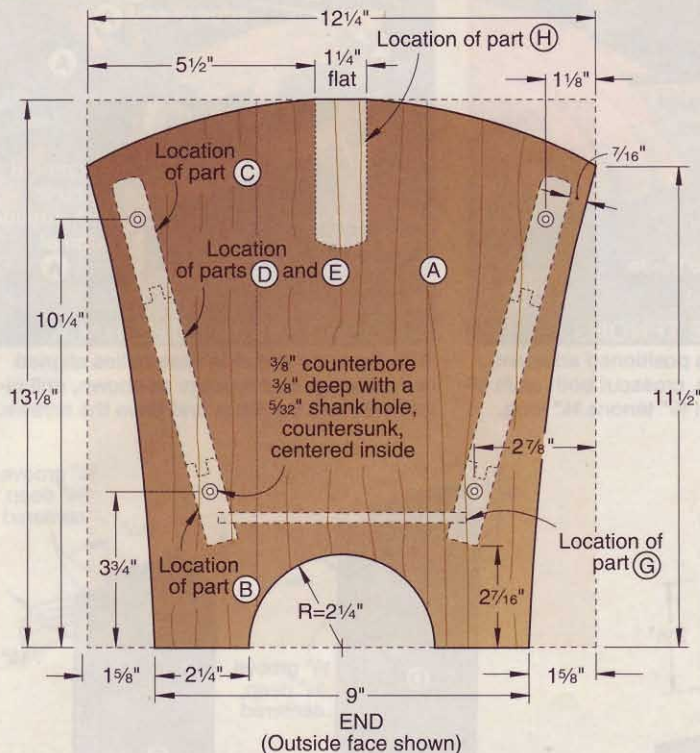

A ADHERE THE END HALF PATTERNS

Align and adhere the pattern halves to the blank for each end (A), positioning one pattern half faceup and the other facedown.

cut a 1/4" groove 3/8" deep, centered, along the *inside* edges of the bottom rails (B), top rails (C), and end stiles (D), and *both* edges of the center stiles (E), where shown on **Drawings 3** and **3a**. Sand the parts smooth.

4 To form 1/4" tenons 3/8" long on both ends of the end stiles (D) and center stiles (E) to fit the grooves in the bottom rails (B) and top rails (C), where shown, refit your tablesaw with a 3/8" dado blade raised to 1/4". Attach an auxiliary fence to the rip fence and an extension to the miter gauge. Using the auxiliary fence as a stop, as shown in **Photo C**, crosscut both ends of the stiles on both faces to create the tenons. (We made test cuts in a cutoff first to verify the setup.)

5 Mark the center and ends of the arch on each top rail (C), where dimensioned on **Drawing 3**. Draw the arches using a fairing stick. (Go to woodmagazine.com/fairing for a free fairing stick plan.) Then bandsaw the arches to shape, saving the cutoffs. Do not sand and round over the top edges until indicated.

6 From 3/4"-thick stock resawn or planed to 1/4" thick, cut the four panels (F) and bottom (G) to the sizes listed. Sand the parts to 220 grit, and remove the dust. Then apply two coats of a clear finish to both faces of the parts. (We used AquaZar Water-Based Clear Satin Polyurethane, sanding to 320 grit between coats. For two other ways to finish walnut, see the article on [page 32](#).) Prefinishing the panels and bottom prevents unfinished edges from showing when the wood shrinks during seasonal changes.

Now make the sides

1 From 3/4"-thick stock, cut the bottom rails (B), top rails (C), end stiles (D), and center stiles (E) to the sizes listed in the **Materials List**, except rip the top rails (C) to 4" wide. (Cutting the top rails extra wide lets you use the curved cutoffs from the top edges as clamping aids later.)

2 Using a dado blade angled 15° from vertical in your tablesaw, cut a 1/4" groove 3/8" deep 3/8" from the *bottom* edge on the *inside* face of each bottom rail (B), where shown on **Drawings 2** and **3** and as shown in **Photo B** on [page 78](#).

3 Return the dado blade to vertical. Adjusting the blade height and fence, as needed,

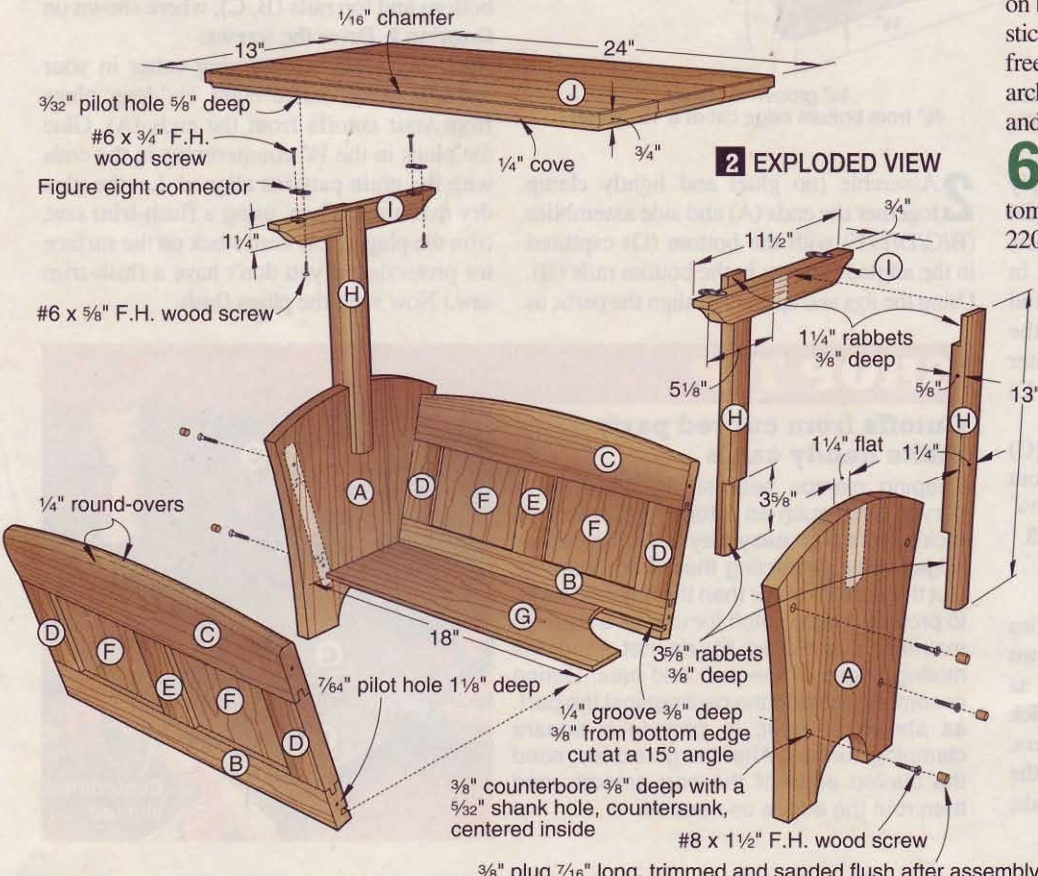

2 EXPLODED VIEW

2a FIGURE EIGHT CONNECTOR DETAIL

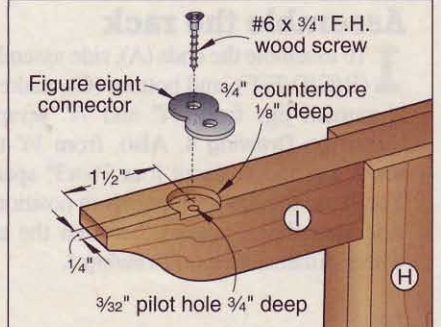



B CUT THE BOTTOM-RAIL GROOVE

Using a pushblock to safely guide and hold each bottom rail (B) tight against your rip fence, cut an angled $\frac{1}{4}$ " groove in the rail.



C FORM THE STILE TENONS

With an auxiliary fence positioned adjacent to your $\frac{3}{8}$ " dado blade, crosscut both ends of the stiles (D, E) to form $\frac{1}{4}$ " tenons $\frac{3}{8}$ " long.

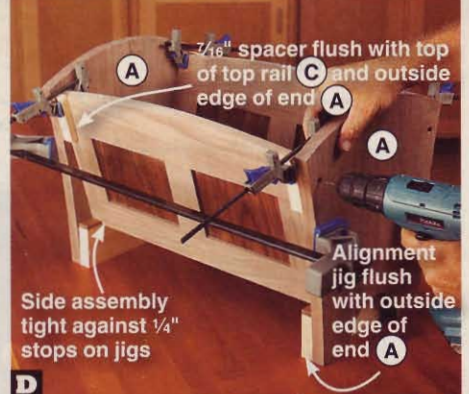

D ALIGN/ASSEMBLE THE RACK

With the ends and side assemblies aligned using the jigs and spacers as shown, drill pilot holes into the sides and drive the screws.

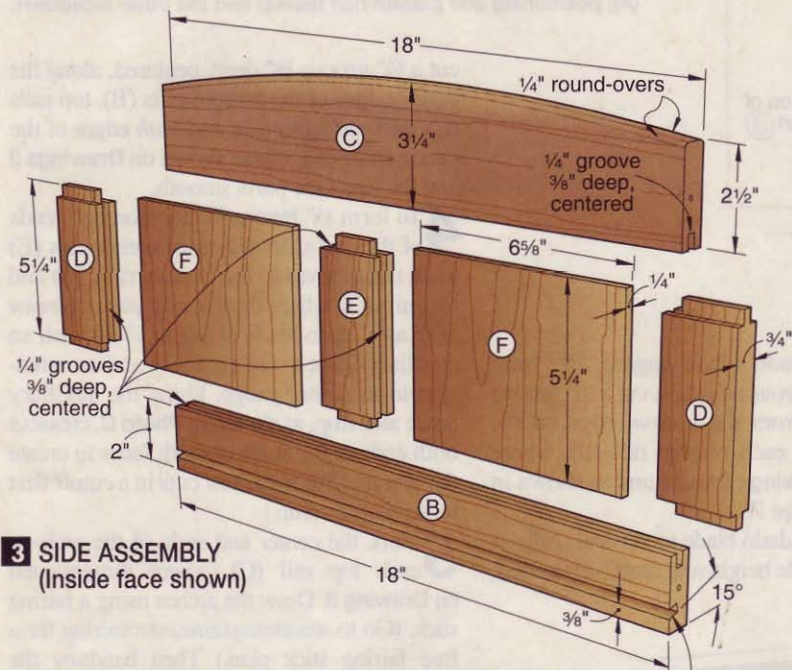

3 SIDE ASSEMBLY (Inside face shown)

7 To assemble the sides, draw centerlines on masking tape on the bottom rails (B), top rails (C), and center stiles (E) on the *inside* faces for aligning the stiles. Apply glue *only* to the tenons of the end stiles (D) and center stiles. Then, using the cutoffs from the top rails as cauls, as explained in the **Shop Tip**, *below right*, assemble and clamp together the rails and stiles with the panels (F) captured in the grooves, the center stiles aligned, and the ends of the rails (B, C) flush with the end stiles.

8 After the glue dries, sand the top rail (C) arches smooth. Then round over the front and back edges of each arch using a $\frac{1}{4}$ " round-over bit, where shown on **Drawing 3**.

Assemble the rack

1 To assemble the ends (A), side assemblies (B/C/D/E/F), and bottom (G), make two alignment jigs from $\frac{1}{4}$ " and $\frac{3}{4}$ " scrap, as shown on **Drawing 4**. Also, from $\frac{3}{4}$ "-thick scrap, rip and crosscut four $\frac{7}{16} \times 3$ " spacers. You'll use the jigs and spacers to position the side assemblies, angled, between the ends, where dimensioned on **Drawing 1**.

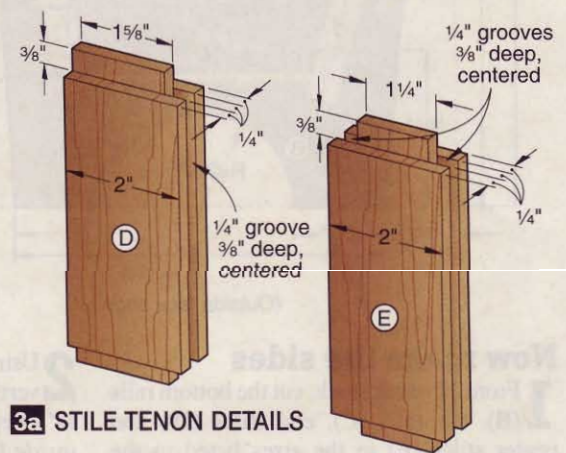

3a STILE TENON DETAILS

shown in **Photo D**, tighten the clamps. Then, using the mounting holes in the ends (A) as guides, drill pilot holes into the ends of the bottom and top rails (B, C), where shown on **Drawing 2**. Drive the screws.

3 Using a $\frac{3}{8}$ " tapered plug cutter in your drill press, make eight $\frac{7}{16}$ "-long plugs from your cutoffs from the ends (A). Glue the plugs in the $\frac{3}{8}$ " counterbores in the ends with the grain patterns aligned. Let the glue dry overnight. Then, using a flush-trim saw, trim the plugs. (Lay card stock on the surface for protection if you don't have a flush-trim saw.) Now sand the plugs flush.

$\frac{1}{4}$ " groove $\frac{3}{8}$ " deep
 $\frac{3}{8}$ " from bottom edge cut at a 15° angle

2 Assemble (no glue) and lightly clamp together the ends (A) and side assemblies (B/C/D/E/F) with the bottom (G) captured in the angled grooves in the bottom rails (B). Using the jigs and spacers to align the parts, as

SHOP TIP

Cutoffs from curved parts make handy cauls

Keeping clamps securely in place on a curved part, such as a top rail (C), can be tricky. Here's an easy way to clamp curved edges while protecting them from marring. Cut the part $\frac{3}{4}$ " wider than the finished width to provide a rigid cutoff for use as a caul. To maintain a matched fit, do not sand the mating edges of the part and caul. During assembly, position the caul against the part, as shown at *right*, to provide a square clamping surface. After the glue dries, sand the curved edge of the part smooth, and then rout the edges as needed.

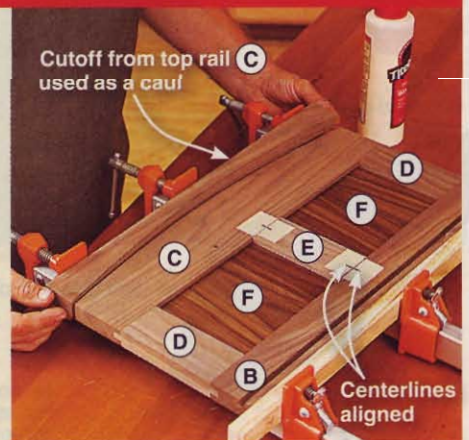

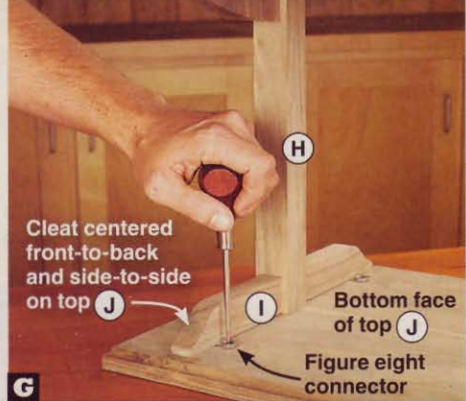
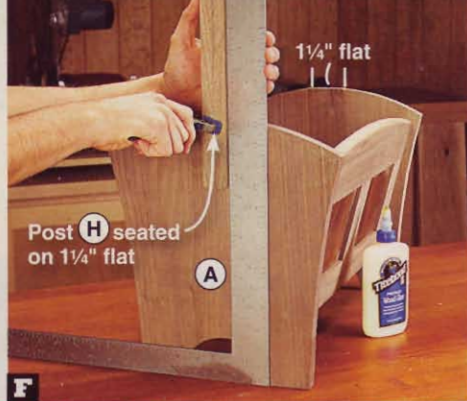
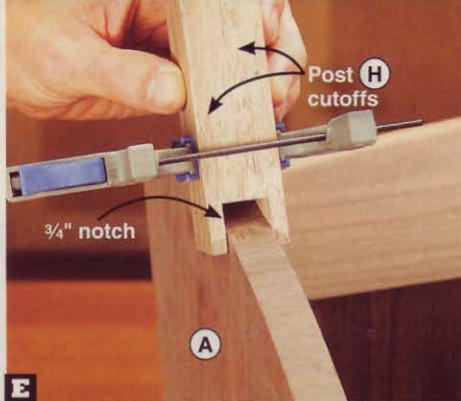

TEST-FIT FOR THE POST NOTCHES, AND THEN MOUNT THE POST/CLEAT ASSEMBLIES AND TOP

Clamp together the post (H) cutoffs with the rabbets facing inside. Slip the notch over an end (A), and check for a snug fit.

Glue and clamp each post/cleat assembly (H/I) to an end (A), using a framing square to plumb the assembly.

With the cleats (I) centered front-to-back and side-to-side on the top (J), mark the centers of the figure eight connectors using an awl.

4 SIDE ASSEMBLY ALIGNMENT JIG

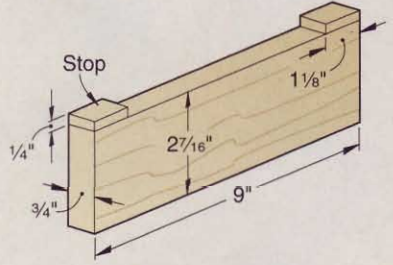

Add the top

1 From 3/4"-thick stock planed to 5/8" thick, cut four 1 1/4"x13" pieces to form the two 1 1/4"-thick laminated posts (H), saving your cutoffs. Also, cut two 1 1/4"x11 1/2" pieces from 3/4" stock for the cleats (I).

2 Fit your tablesaw with a 3/4" dado blade. Using an auxiliary fence on the rip fence as a stop and an extension on the miter gauge for backup, cut a 3/4" rabbet 3/8" deep in one end of two of your post cutoffs. Clamp the cutoffs together, and test-fit the 3/4" notch on an end (A), as shown in **Photo E**. Adjust your setup, if needed. Then cut 3 3/8" rabbets in one end of each of the four post halves (H) to fit over the ends (A) and 1 1/4" rabbets in the other ends to receive the cleats (I), where shown on **Drawing 2**.

3 Laminate and clamp the post (H) halves together, keeping the edges flush. After the glue dries, make two copies of the post full-size bottom pattern. Adhere a copy to

one face of each post. Bandsaw and sand the posts to shape, and remove the patterns.

4 Mark two centerpoints on the top edge of each cleat (I), where dimensioned on **Drawing 2a**, for 3/4" counterbores to receive figure eight connectors. Using a Forstner bit in your drill press, bore the 1/8"-deep holes. Then drill 3/32" pilot holes 3/4" deep, centered in the counterbores.

5 Make four copies of the cleat end pattern. Adhere two patterns to the ends of each cleat (I). (You'll need to flip one pattern over on each cleat.) Bandsaw and sand to shape, and remove the patterns.

6 Glue and clamp a cleat (I) in the small notched end of each post (H), centering the cleat end-to-end. Then glue and clamp each post/cleat assembly (H/I) to an end (A), tight against the 1/4" flat area, where shown on **Drawing 2** and as shown in **Photo F**.

7 Edge-join 3/4"-thick stock to form a 13 1/2"x24 1/2" blank for the top (J). Then crosscut the ends and rip the edges to the finished size of 13x24".

8 Chuck a 1/4" cove bit in your handheld or table-mounted router. Rout a cove along the ends and then edges on the *bottom* face of the top (J), where shown on **Drawing 2**. Switch to a 45° chamfer bit. Then rout a 1/16" chamfer along the ends and edges on the *top* face. Sand the top smooth.

9 Place the top (J) on your workbench with the *bottom* face up. Next, screw-mount figure eight connectors in the counterbores

in the cleats (I), where shown on **Drawings 2** and **2a**. Now position the magazine rack on the top, centering the cleats front-to-back and side-to-side. Mark the centers of the figure eight connectors, as shown in **Photo G**. Drill 3/32" pilot holes 3/8" deep into the top, and drive the screws.

Finish up

1 Remove the top (J). Sand any areas that need it to 220 grit, and remove the dust. Apply two coats of clear finish to the parts, as before.

2 Remount the top (J). Then place the rack where desired, and fill it with your favorite books and periodicals, including *WOOD*® magazine, of course! 📖

Written by **Owen Duvall**
Project design: **Jeff Mertz**
Illustrations: **Roxanne LeMoine; Lorna Johnson**

Cutting Diagram

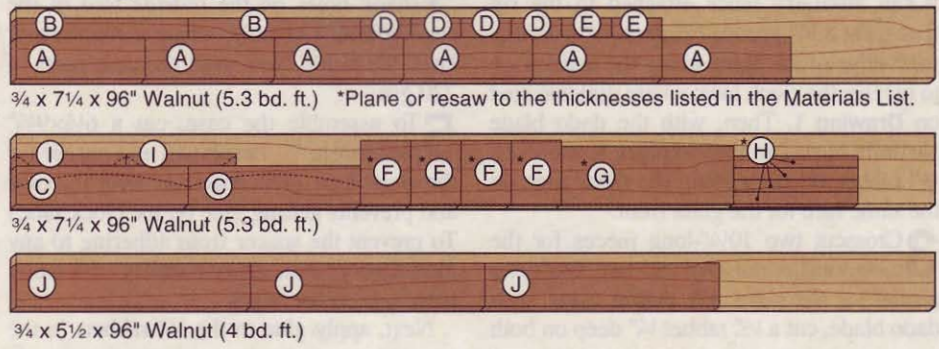

Materials List

Part	FINISHED SIZE			Matl.	Qty.
	T	W	L		
A* ends	3/4"	12 1/4"	13 1/8"	EW	2
B bottom rails	3/4"	2"	18"	W	2
C* top rails	3/4"	3 1/4"	18"	W	2
D end stiles	3/4"	2"	5 1/4"	W	4
E center stiles	3/4"	2"	5 1/4"	W	2
F panels	1/4"	6 5/8"	5 1/4"	W	4
G bottom	1/4"	6"	18"	W	1
H posts	1 1/4"	1 1/4"	13"	LW	2
I cleats	3/4"	1 1/4"	11 1/2"	W	2
J* top	3/4"	13"	24"	EW	1

*Parts initially cut oversize. See the instructions.
Materials key: EW—edge-jointed walnut, W—walnut, LW—laminated walnut.

Supplies: Spray adhesive, #8x1 1/2" flathead wood screws (8), #6x3/4" flathead wood screws (4), #6x5/8" flathead wood screws (4).

Blades and bits: Dado-blade set; 1/4" round-over, 1/4" cove, and 45° chamfer router bits; 3/8" tapered plug cutter; 3/4" Forstner bit.

Source

Hardware: Figure eight connectors no. 13K01.50, \$2.10 pkg. of 20 (1 pkg.). Call or click Lee Valley, 800/871-8158, leevalley.com.



arts & crafts

mantel clock

Whether placed above a fireplace or on a shelf, this timeless masterpiece will draw admiring eyes for generations.

Although this clock looks sophisticated, you'll find it simple to build. Easy-to-make false tenons give the appearance of traditional through-tenon joinery without the layout, mortising, and fitting challenges. And full-size patterns make cutting the false tenons and tapered clock sides a snap. See the end of this article for a convenient source for the clock movement and handsome copper-overlay clock face.

Let's start with the quick 'n' easy case

1 From $\frac{3}{4}$ "-thick stock planed to $\frac{1}{2}$ " thick (we used quartersawn white oak), cut a

$1\frac{1}{4}\times 36$ " blank to form the case top/bottom (A) and case sides (B).

2 Using a dado blade in your tablesaw and an auxiliary fence attached to the rip fence, cut a $\frac{1}{4}$ " groove $\frac{1}{4}$ " deep $\frac{3}{8}$ " from the front edge of the blank along the inside face to receive the clock face, where dimensioned on **Drawing 1**. Then, with the dado blade partially buried in the auxiliary fence, cut a $\frac{1}{8}$ " rabbet $\frac{1}{4}$ " deep along the front edge on the same face for the glass front.

3 Crosscut two $10\frac{1}{4}$ "-long pieces for the case top/bottom (A) and two $6\frac{1}{8}$ "-long pieces for the sides (B). Again using your dado blade, cut a $\frac{1}{2}$ " rabbet $\frac{1}{4}$ " deep on both

ends of the top/bottom on the inside face, where shown.

4 Mark centerpoints for four countersunk shank holes on the outside face of the case bottom (A) only, where dimensioned. Drill the holes. Now sand the case parts to 220 grit.

5 To assemble the case, cut a $6\frac{1}{8}\times 9\frac{3}{4}$ " piece from $\frac{1}{4}$ " hardboard as a spacer for the clock face. (The spacer squares the case and prevents getting glue on the clock face.) To prevent the spacer from adhering to any glue squeeze-out, apply paraffin or a wood paste wax to the edges.

Next, apply glue to the $\frac{1}{2}$ " rabbets in the

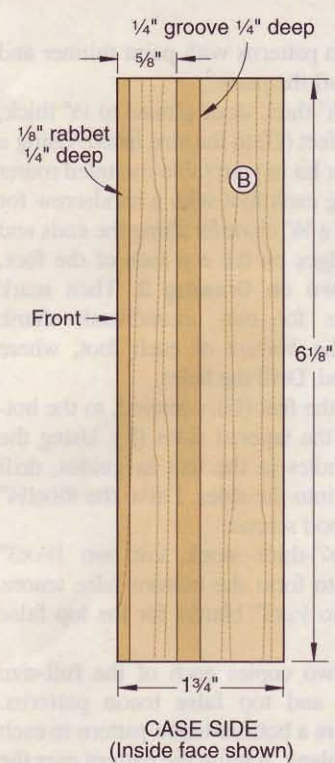

1 PARTS VIEW

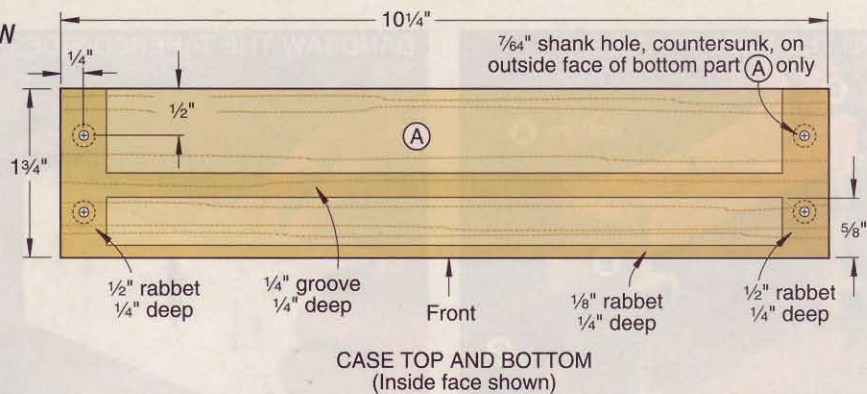

CASE TOP AND BOTTOM
(Inside face shown)



With the case top/bottom (A), sides (B), and 1/4" spacer clamped together, drill pilot holes and drive the screws through the bottom (A).

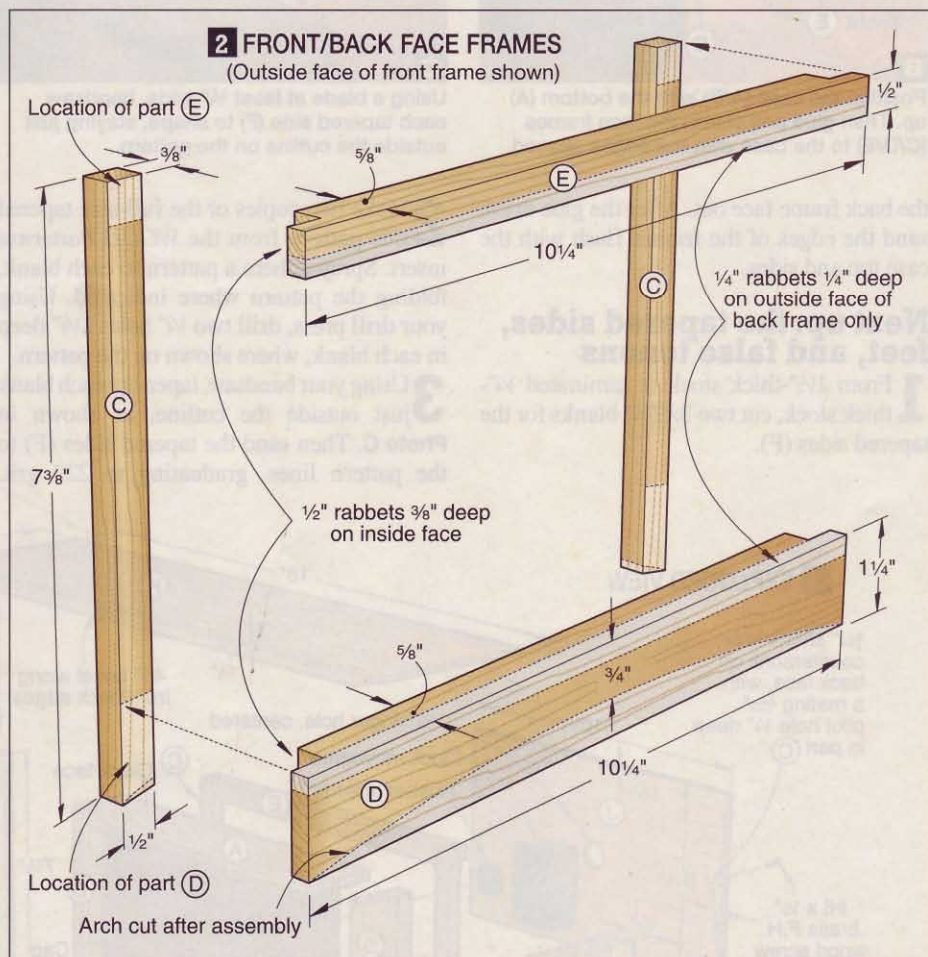

case top (A). **Do not apply glue to the rabbets in the case bottom (A) so that you can remove it later to install the clock face and glass.** Now clamp together the case top/bottom and case sides (B) with the spacer captured in the 1/4" grooves, as shown in **Photo A**. Using the shank holes in the case bottom as guides, drill pilot holes into the case sides, and drive the screws. Set the case aside, leaving the spacer in place.

Now add the face frames to the case front and back

1 From 3/4"-thick stock resawn or planed to 3/8" thick, cut the face-frame stiles (C)

to the size listed in the **Materials List**. Then, from 3/4"-thick stock planed to 5/8" thick, cut the face-frame bottom rails (D) and top rails (E) to the sizes listed.

2 Using a dado blade, cut 1/2" rabbets 3/8" deep on both ends of each face-frame bottom rail (D) and top rail (E) on the *inside* faces, where shown on **Drawing 2**, to fit the face-frame stiles (C). Then, on the *outside* faces of the bottom rail (D) and top rail (E) for the *back* face frame only, cut or rout a 1/4" rabbet 1/4" deep along the *inside* edges, where shown, to receive the back (J).

3 Glue and clamp the face-frame stiles (C) and bottom and top rails (D, E) together

to form the front and back frames, checking for square. After the glue dries, mark the center of the arch on each bottom rail (D), where dimensioned. Draw the arches using a fairing stick. Then bandsaw and sand the arches to shape. (For a free fairing stick plan, go to woodmagazine.com/fairing.)

4 To assemble the face frames (C/D/E) to the case, where shown on **Drawing 3**, apply glue to the front and back edges of the case top (A) and sides (B). **Do not apply glue to the edges of the case bottom (A).** Now align and clamp the face frames to the case, as shown in **Photo B**, making sure the 1/4" rabbets in the bottom and top rails (D, E) of

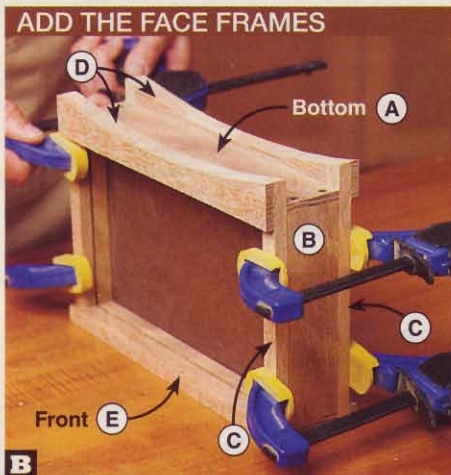

B Position the case (A/B) with the bottom (A) up. Then glue and clamp the face frames (C/D/E) to the case with the edges aligned.

the back frame face out. After the glue dries, sand the edges of the frames flush with the case top and sides.

Next up: the tapered sides, feet, and false tenons

1 From 1½"-thick stock or laminated ¾"-thick stock, cut two 3×7⅞" blanks for the tapered sides (F).

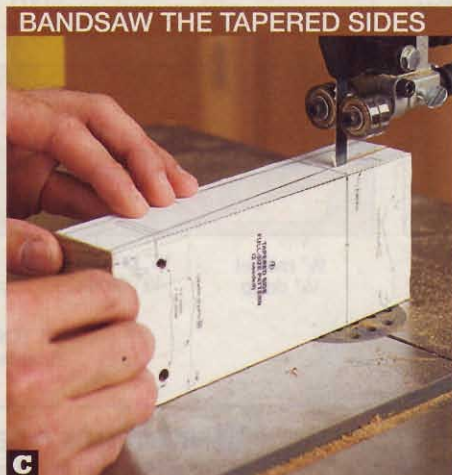

C Using a blade at least ¼" wide, bandsaw each tapered side (F) to shape, staying just outside the cutline on the pattern.

2 Make two copies of the full-size tapered side pattern from the *WOOD Patterns*® insert. Spray-adhere a pattern to each blank, folding the pattern where indicated. Using your drill press, drill two ¼" holes 1⅞" deep in each blank, where shown on the pattern.

3 Using your bandsaw, taper-cut each blank just outside the cutline, as shown in **Photo C**. Then sand the tapered sides (F) to the pattern lines, graduating to 220 grit.

Moisten the patterns with paint thinner and peel them off the parts.

4 From ¾"-thick stock planed to ½" thick, cut the feet (G) to the size listed. Using a 45° chamfer bit in your table-mounted router and holding each foot with a handscrew for safety, rout a ⅜" chamfer along the ends and then the edges on the top face of the foot, where shown on **Drawing 3**. Then mark centerpoints for two countersunk shank holes on the bottom of each foot, where dimensioned. Drill the holes.

5 Clamp the feet (G), centered, to the bottom of the tapered sides (F). Using the mounting holes in the feet as guides, drill pilot holes into the sides. Drive the #8×1¼" flathead wood screws.

6 From ¾"-thick stock, cut two 1¼×3" blanks to form the bottom false tenons (H) and two ½×3" blanks for the top false tenons (I).

7 Make two copies each of the full-size bottom and top false tenon patterns. Spray-adhere a bottom-tenon pattern to each ¾×1¼×3" blank, folding the pattern over the ends of the blank, where shown. Then adhere a top-tenon pattern to a face of each ¾×½×3" blank. Using your drill press, drill a ¼" hole ⅓⅛" deep in both ends of each bottom-tenon

3 EXPLODED VIEW

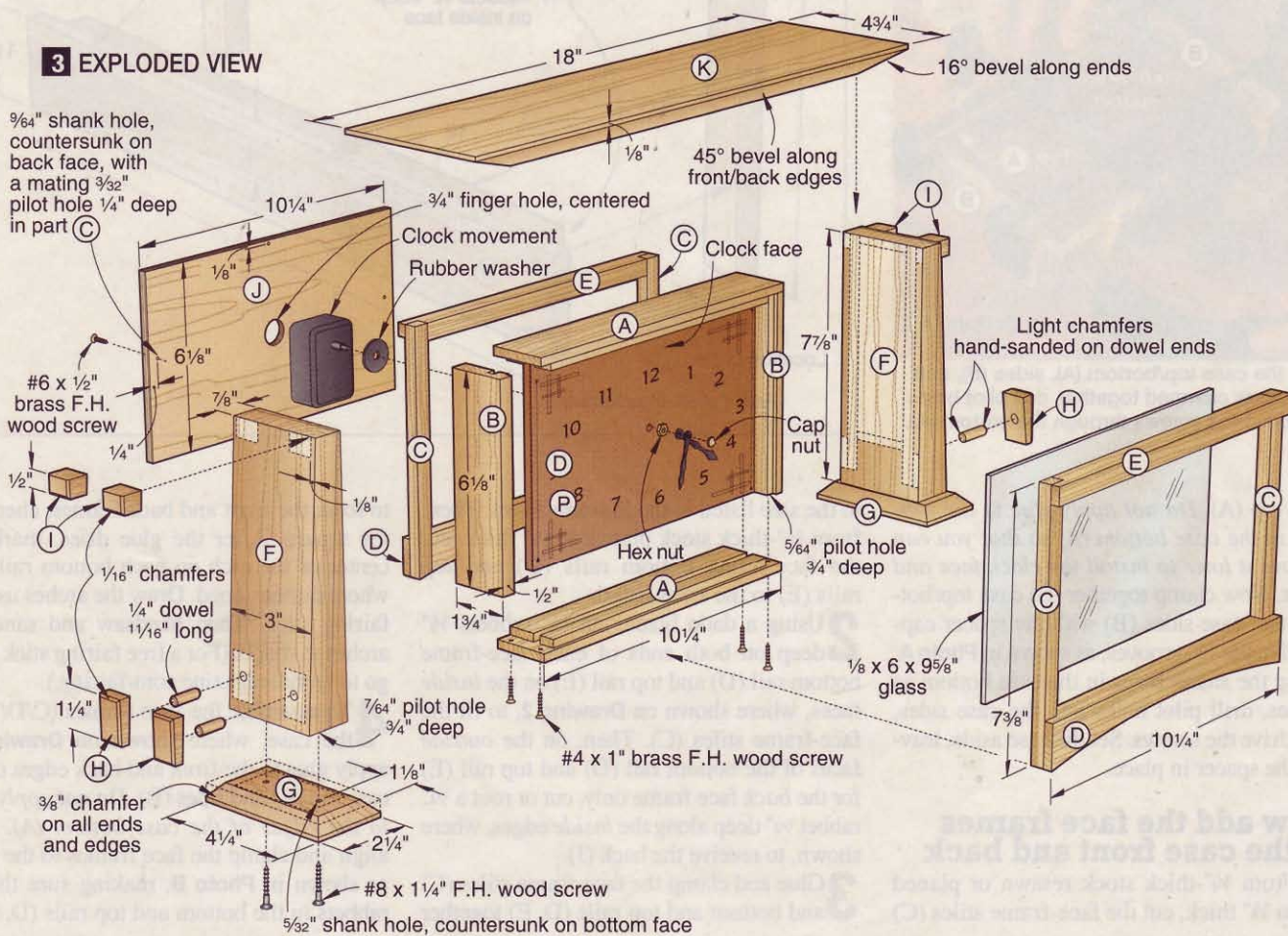

blank, where shown on the patterns and as shown in **Photo D**.

8 Using your bandsaw or a scrollsaw with a #2 reverse-tooth blade, separate the two bottom false tenons (H) from each blank by cutting along the nonangled ends of the tenons ("Cut 1" on the patterns). Then, holding each tenon with a handscrew, cut along the angled line ("Cut 2"). Next, separate the two top false tenons (I) from each blank by cutting along the angled cutlines. Using a sanding block, sand the tenons smooth. Now sand a 1/16" chamfer on the front edges of the tenons, where shown on the patterns and **Drawing 3**. Remove the patterns. Set the top tenons aside.

9 From a 1/4"-diameter birch dowel 6" long, cut four 1 1/16"-long pieces for mounting the bottom false tenons (H) to the tapered sides (F), where shown on **Drawing 3**. To ease insertion into the mating holes, hand-sand a light chamfer on both ends of each dowel. Then glue and clamp the dowels in the holes in the tenons (not the tapered sides). After the glue dries, test-fit (no glue) the dowels in the holes in the tapered sides to verify the tenons seat tight against the sides. Trim the dowels, if needed. Now glue and clamp the dowels and tenons in place.

10 Apply glue to the case sides (B). Then clamp the tapered side assemblies (F/G/H) to the case, flush with the outside faces of the face-frame bottom and top rails (D, E) at the front and back, as shown in **Photo E**.

Time to make the back and top, and finish up

1 From 1/4" oak plywood, cut the back (J) to size to fit the clock opening. Using a Forstner bit in your drill press and a backer to prevent tear-out, bore a 3/4" hole for finger access, centered, through the back. Position the back in the opening. Then drill four countersunk shank and pilot holes through the back and into the face-frame stiles (C) and bottom and top rails (D, E), where dimensioned on **Drawing 3**. Drive the #6x1/2" brass flathead wood screws.

2 From 3/4"-thick stock planed to 5/8" thick, cut the top (K) to size. Tilt your tablesaw blade 16° from vertical. Then, using a carrier board or a rip-fence saddle on your fence, bevel-rip the ends of the top on the bottom face, where shown. (For a free rip-fence saddle plan, go to woodmagazine.com/saddle.) Now tilt the blade to 45°, and bevel-rip the front and back edges. Sand the top smooth.

3 Glue and clamp the top (K) to the clock, centered front-to-back and side-to-side. Then glue and clamp the top false tenons (I) to the top, tight against the tapered sides (F) and 1/8" from the edges of the sides, where shown on **Drawing 3**.

4 Remove the feet (G), back (J), case bottom (A), and 1/4" hardboard spacer. Sand any areas of the clock that need it to 220 grit, and remove the dust. Then apply a stain, if you wish, and a clear finish. (We used Varathane Premium Wood Stain no. 263, Mission Oak, followed by three coats of Deft aerosol Satin Clear Wood Finish, sanding to 320 grit between coats.)

5 Mount the clock movement and hands to the clock face, using the supplied rubber washer, hex nut, and cap nut, where shown on **Drawing 3**. Insert a AA-size battery in the movement and set the time, following the supplied instructions. Now slide the clock face into the 1/4" grooves in the case.

6 Finally, have a piece of 1/8"-thick glass cut to 6x9 5/8". Clean the glass. Then slide it into the 1/8" grooves in the case behind the front face frame. Remount the case bottom (A), feet (G), and back (J). Now display your timepiece where everyone can admire it and your craftsmanship. 🌟

Materials List

Part	FINISHED SIZE			Matl.	Qty.
	T	W	L		
A* case top/bottom	1/2"	1 3/4"	10 1/4"	QWO	2
B* case sides	1/2"	1 3/4"	6 1/8"	QWO	2
C face-frame stiles	3/8"	1/2"	7 3/8"	QWO	4
D face-frame bottom rails	5/8"	1 1/4"	10 1/4"	QWO	2
E face-frame top rails	5/8"	1/2"	10 1/4"	QWO	2
F* tapered sides	1 3/8"	3"	7 7/8"	LQWO	2
G feet	1/2"	2 1/4"	4 1/4"	QWO	2
H* bottom false tenons	3/4"	1 1/4"	3/8"	QWO	4
I* top false tenons	3/4"	1/2"	5/8"	QWO	4
J back	1/4"	6 1/8"	10 1/4"	OP	1
K top	5/8"	4 3/4"	18"	QWO	1

*Parts initially cut oversize. See the instructions.

Materials key: QWO—quartersawn white oak, LQWO—laminated quartersawn white oak, OP—oak plywood.

Supplies: Paraffin or wood paste wax, spray adhesive, #4x1" and #6x1/2" brass flathead wood screws (4 ea.), #8x1 1/4" flathead wood screws (4), 1/4"-diameter birch dowel 6" long, 1/8x6x9 5/8" glass, AA-size battery.

Blades and bits: Dado-blade set, 45° chamfer router bit, #2 reverse-tooth scrollsaw blade, 3/4" Forstner bit.

Source

Clock kit: Clock movement and clock face, kit no. 200CRT, \$29.95 ppd. Add \$24.95 for each additional kit. Schlaubaugh & Sons Woodworking, 720 14th Street, Kalona, IA 52247. Call 800/346-9663.

Written by **Owen Duvall** with **Kevin Boyle**

Project design: **Schlaubaugh & Sons**

Illustrations: **Roxanne LeMoine; Lorna Johnson**

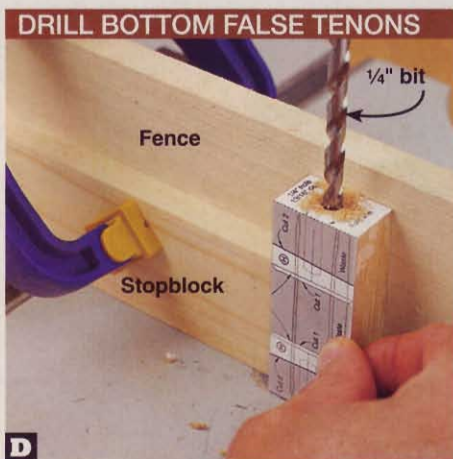

D Holding a blank for the bottom false tenons (H) tight against a stopblock and fence, drill a 1/4" hole 1 3/16" deep in each end of the blank.

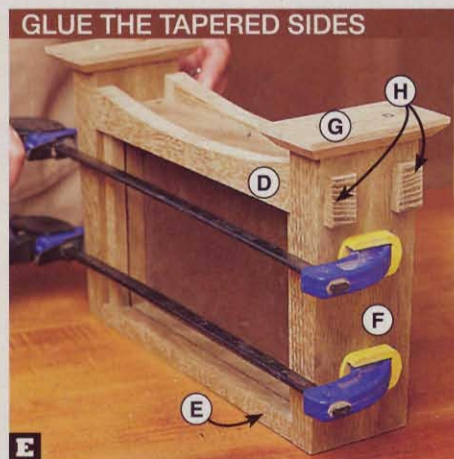

E Glue and clamp the tapered side assemblies (F/G/H) to the case sides (B), flush with the face-frame bottom and top rails (D, E).

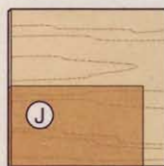

Cutting Diagram

1/4 x 12 x 12" Oak plywood

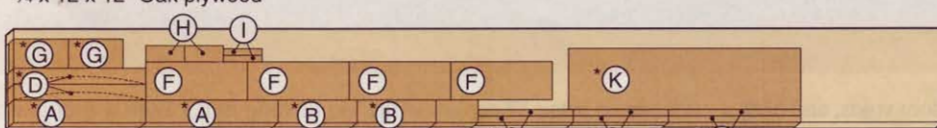

3/4 x 7 1/4 x 72" Quartersawn white oak (4 bd. ft.)

*Plane or resaw to the thicknesses listed in the Materials List.

eye-pleasing platter

The graceful, shallow profile of this 10"-diameter platter makes it the perfect project for showcasing fancy grain.

Maple burl



Redwood burl

With its spectacular swirling grain, random voids, and bark inclusions, few materials look better in a finished turning than burl. (See **Source** for a burl-blank supplier, and the

sidebar on *page 87* for some tips on turning burl.) With a four-jaw chuck and a screw center, you can turn out an impressive platter in an afternoon. Here's how.

1 Create the templates and mount the blank

Make a photocopy of the two templates on the *WOOD Patterns*® insert, and adhere them with spray adhesive to 1/8" tempered hardboard. Scrollsaw, and then sand the templates to shape, as shown at *right*. Mark the center of the top face of a 1 3/4 x 10 1/2 x 10 1/2" turning blank, and draw a 10 1/2"-diameter circle on it. (See the **Shop Tip**, below.) Bandsaw the blank to shape. Then drill a centered pilot hole sized to fit your screw center in the top face of the blank. Clamp the screw center into your four-jaw chuck, and mount the blank, as shown at *far right*. Now support the blank with the tail center.

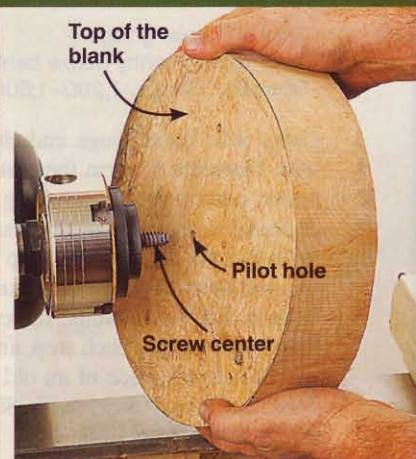
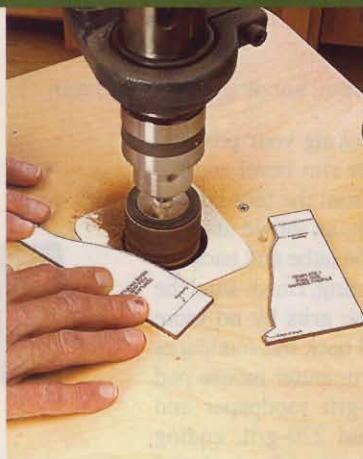
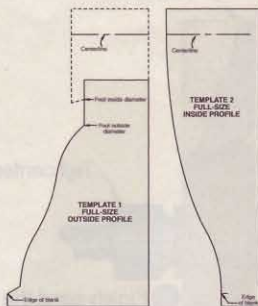

2 True the edge and bottom

Tool: 3/8" bowl gouge.
Tool rest: Slightly below center.
Speed: 600–800 rpm.

True the edge of the blank with your bowl gouge, reducing the blank to 10" in diameter. Then true the bottom face, cutting from the edge to the center, as shown at *right*. Work as close as possible to the tail center.

Note: Because of the swirling nature of burl grain, you may find in some instances that pulling your cut from the center to the edge gives you a smoother surface.

Now mark the bottom and top of the platter rim bevel with pencil lines on the edge of the blank, 1/4" and 1 1/2" respectively from the bottom face. Mark the foot outside diameter with a 3 1/2"-diameter circle and the foot inside diameter with a 2 1/2"-diameter circle.

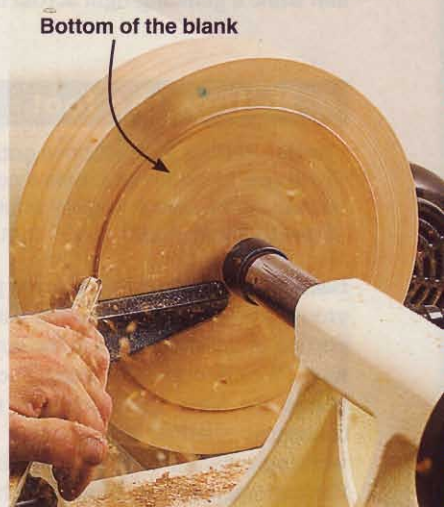
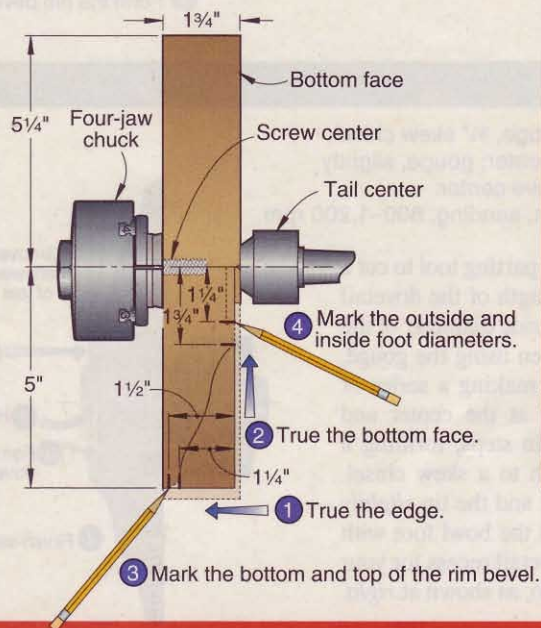

SHOP TIP

Disks do the job when a compass can't

Before you mount a turning blank on your lathe, you'll bandsaw it round for balance and to avoid the punishing task of roughing it to round on the lathe. To guide the bandsaw blade on a flat blank, you can draw a circle with a compass, but you'll need another method when rounding a blank cut from a log. Here's a trick that professional turners use.

From scraps of 1/4" hardboard or plywood, bandsaw a series of disks starting at 5" in diameter and increasing in 1/2" increments up to the capacity of your lathe. Drill a 1/8" hole at the center of each disk. To mark a half-log blank, fasten the appropriate disk to the blank with a wood screw through the center hole. Then, guiding the blade along the

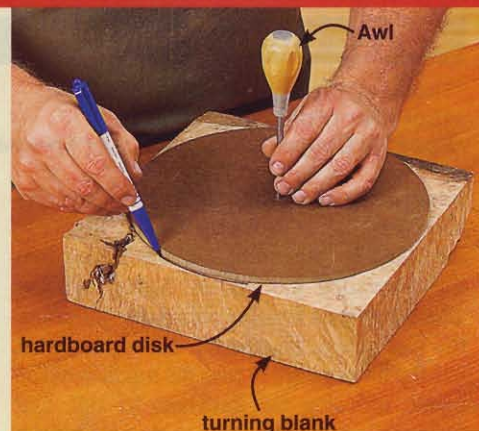

edge of the disk, bandsaw the blank, as shown above. (To make turning blanks from a log, see page 102.) Once you make a set of disks, you'll find them handy for

marking flat blanks too. Just position a disk on the blank, anchor it with an awl through the center hole, and trace the circle, as shown above.

3 Form the bottom profile

Tool: 1/2" bowl gouge.

Tool rest: Slightly below center.

Speeds: Gouge, 1,200–1,600 rpm; sanding, 800–1,200 rpm

Using your bowl gouge and checking your progress with **Template 1**, form the platter rim bevel and the platter bottom profile, working from the foot outside diameter to the edge of the blank, as shown at *right*. With the profile complete, stop the lathe and back the tool rest away. With the lathe running, finish-sand the bottom. For best results, increase grits by no more than 50 percent at each step, and back the sandpaper with a pad. (A piece of an old computer mouse pad does the trick.) Start with 80-grit sandpaper and progress through 120-, 180-, and 220-grit, ending with 320-grit. To inspect the turning for tool and scratch marks as you progress through the grits, remove the dust, wet the surface with paint thinner, and shine a glancing light across the surface.

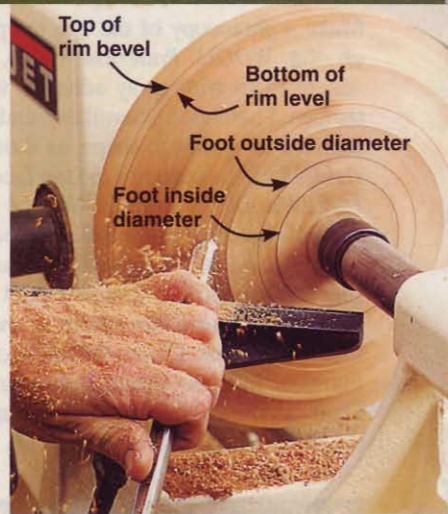
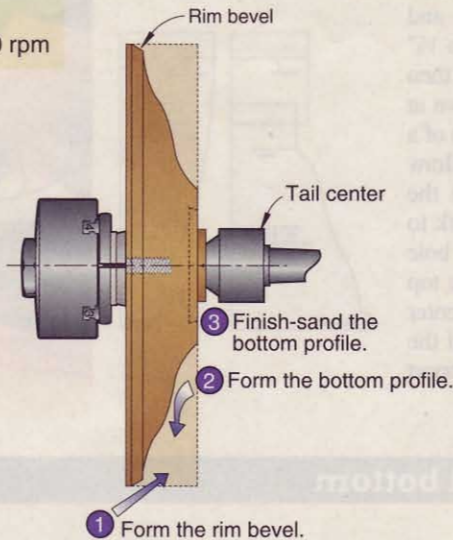

4 Hollow the foot

Tools: Parting tool, 1/2" bowl gouge, 3/4" skew chisel.

Tool rest: Parting tool, below center; gouge, slightly below center; skew, slightly above center.

Speed: Tools, 1,200–1,600 rpm; sanding, 800–1,200 rpm.

Back the tail center away. Use the parting tool to cut a groove 1/16" shallower than the length of the dovetail portion of the chuck jaws at the inside diameter of the foot. (We cut ours 3/16" deep.) Then using the gouge, hollow the foot to this depth by making a series of concentric shallow cuts starting at the center and working outward to the groove in steps, forming a flat-bottomed recess. Now switch to a skew chisel. With the tool flat on the tool rest and the tip *slightly* raised, undercut the inside rim of the bowl foot with the toe of the skew, forming a dovetail recess for your four-jaw chuck jaws to expand into, as shown at *right*. Finish-sand the foot.

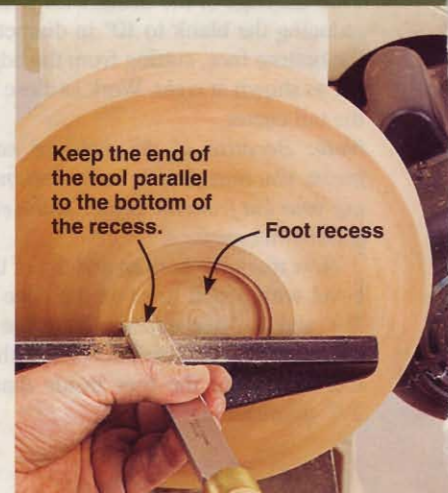
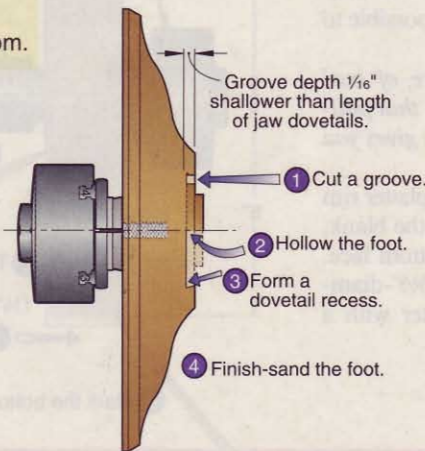

5 True the top surface

Tools: 1/2" bowl gouge, 1/2" Forstner bit.

Tool rest: Slightly below center.

Speeds: Gouge, 1,200–1,600 rpm; Forstner bit, 800 rpm.

Remove the blank from the screw center and the screw center from the chuck. Remount the blank by expanding the chuck jaws into the dovetailed foot recess. Make sure the chuck jaw ends firmly contact the bottom of the foot recess. Engage the tail center. Then use the bowl gouge to true the top face of the blank, reducing the thickness to 1 1/2". Cut from the rim to the center, as shown at *right*, working as close as possible to the tail center. Back the tail center away and check the tightness of the chuck jaws in the foot recess. Now true the blank center.

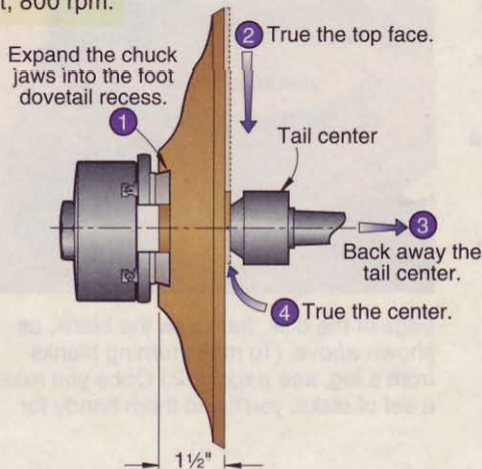

6 Hollow the top of the platter

Tool: 1/2" bowl gouge.
Tool rest: Slightly below center.
Speed: 1,200–1,600 rpm.

To gauge the depth for hollowing the platter, remove the tailstock center, install a drill chuck, and chuck in a 1/2" Forstner bit. Mark a 13/16" depth (1/4" less than finished depth) on the bit with masking tape. With the lathe running, slowly feed the bit into the center of the blank to the marked depth. Now, checking your progress with **Template 2**, use your bowl gouge to hollow the platter by making a series of concentric shallow cuts starting at the center and working outward to the rim in steps, as shown at *right*. Then smooth the interior by making light finishing cuts from the rim to the center. Use double-end calipers to check for uniform wall thickness.

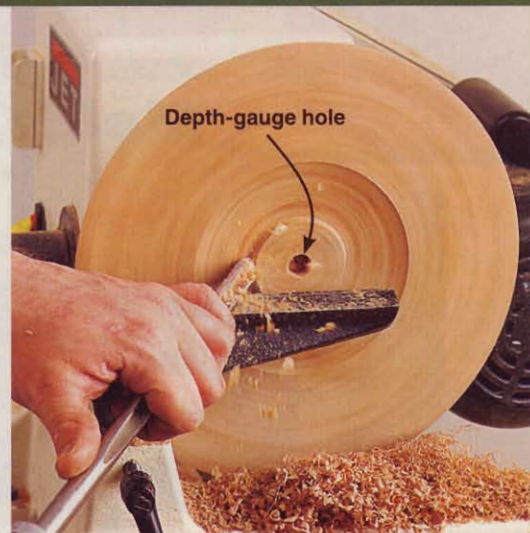
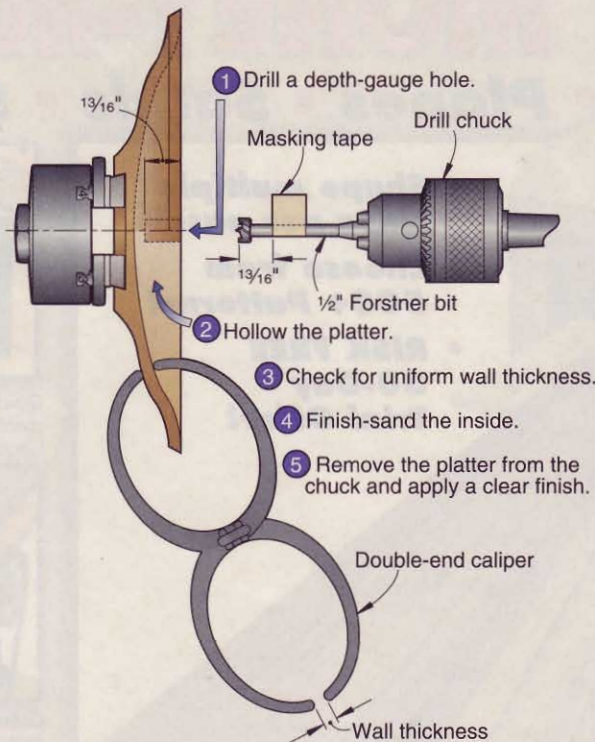

7 Apply the finish

With the profile complete, finish-sand the inside and remove the dust. Cover the lathe bed under the platter. Turning the lathe by hand, apply a liberal coat of oil-polyurethane finish to the top and bottom surfaces. (We used Minwax Antique Oil Finish.) Let the finish penetrate for about 15 minutes, and wipe off any excess. Then switch on the lathe and buff the finish with a paper towel. (A paper towel tears

easily if it catches. Do *not* use a cloth rag.) Remove the platter from the chuck, finish the foot, and let it dry. With the finish dry, rechunk the platter and lightly buff it with an ultra-fine (gray) Scotch-Brite pad. Repeat the finish application until the wood is completely sealed (three to six coats, depending on the porosity of the burl), omitting the Scotch-Brite buffing after the final coat. ♣

QUICK TIPS ON TURNING BURL

Cutting into a burl exposes to view some of the most spectacular grain patterns known to woodworkers. While some species of burl, such as redwood, turn like a dream, others, such as mesquite, are more demanding. Here are a few tips that'll ensure turning success.

Choosing a blank Due to slow and uneven drying, burls may develop cracks and contain deteriorated wood. Avoid blanks with obvious fractures and punky and deteriorated areas.

Design With burl, the grain is the thing. Choose a simple form with a minimum of added design elements. While turning, you may encounter loose bark inclusions. Either carefully remove the inclusions with a pick and leave the void as a feature, or fill the void with colored epoxy.

Turning technique Turn burl with a *sharp* gouge. Avoid scraping. Burls include hard and soft areas, and tools tend to bounce off the hard parts and plow into the soft parts. To eliminate this tool chatter, experiment with lathe speed, both faster *and* slower.

Finishing For a satin sheen, oil finishes are easy and foolproof. Before applying oil, remove wood dust from all fissures with a shop vacuum and compressed air. Oil finishes weep out of burl grain, so wipe the turning several times as it dries. Before applying lacquer for a high-gloss finish, seal the piece with sanding sealer. As the sealer penetrates tiny fissures, it drives out air and may form bubbles as the finish dries. Simply sand out any bubbles and apply more sealer.

New to woodturning or looking for more turned project ideas?

Visit the WOOD Online woodturning forum at woodmagazine.com/turning where you can post questions on this project or any turning technique. Phil Brennon, our turning expert, monitors this forum, and he and other turners will be happy to assist you. To see more woodturning projects go to woodmagazine.com/turnedprojects.

Source

Burl turning blanks. 13/4x101/2x101/2 redwood and maple burl turning blanks (minimum size, actual sizes available may be slightly larger). About \$20 each, price subject to change. From Exotic Burl. Call 800/843-2875 or go to exoticburl.com to check availability and current price.

Written by **Jan Svec** with **Phil Brennon**
Project design: **Jeff Mertz**
Illustrations: **Roxanne LeMoine**

SHOP-TESTED

great glue-up gadgets

Whether you're a toy maker, cabinetmaker or furniture builder, turner or scrollsawyer, you likely use glue. Lots of it. Maybe that's why a quick spin through any woodworking catalog yields an impressive array of applicators designed to help you put the sticky stuff where you need it—on narrow edges; deep

inside biscuit slots and dowel holes; or into the tiniest nooks, crannies, and crevices.

To find out which ones deserve a place on your bench, we bought dozens of the gizmos and tried them all in the *WOOD*® magazine shop. After the honeymoon was over, these five earned a permanent home in our shop.

A BETTER BOTTLE WITHOUT THE GLUE-BLOB BATTLE

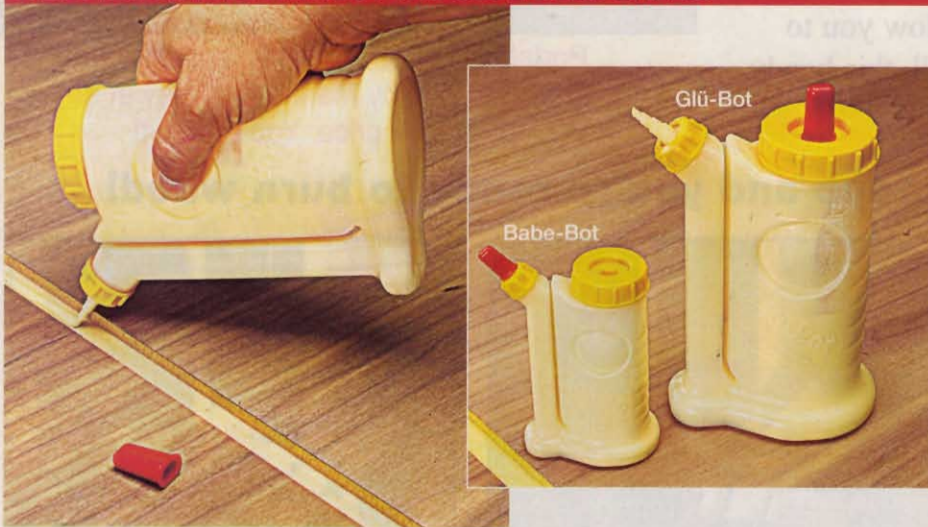

The unique design of Glü-Bot actually makes it suck glue back into the bottle when you stop squeezing. That prevents glue from hardening in the tip and eliminates the messy blob that often oozes from a more traditional glue bottle. It also means the bottom quarter of the glue in the 16-oz. bottle gets to the tip as fast as the top quarter did, saving you time.

Speaking of tips, Glü-Bot comes with interchangeable flat and tapered tips (for biscuit slots, dowel holes, etc.). We especially like the 4-oz. version, called Babe-Bot, for its compact size and maneuverability.

Glü-Bot, \$7; Babe-Bot, \$5; replacement tip kit (5 each, plus caps), \$5.

MULTI-TIP SPREADER SET EXCELS AT GLUING DOWELS

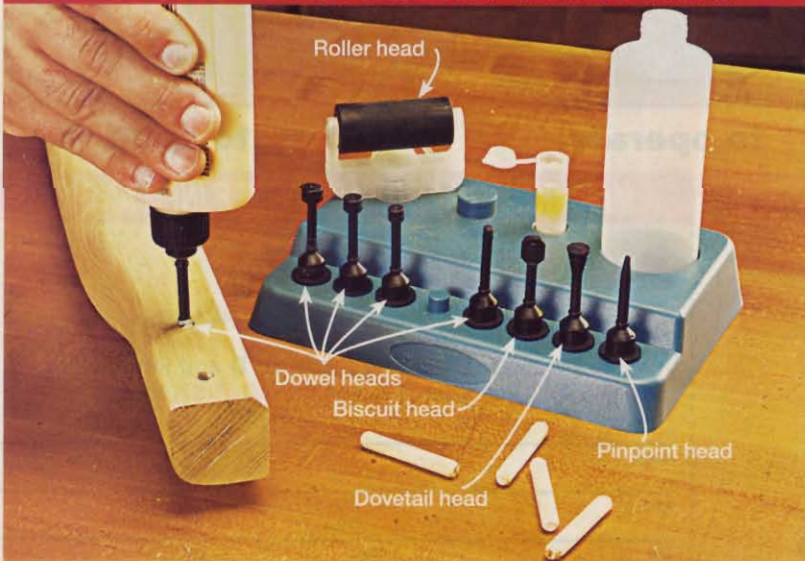

Talk about a glue dispenser that can handle nearly any situation. This comprehensive kit includes nine specialized heads, including a broad roller head for spreading glue on the edges and faces of a workpiece (it works equally well for both applications), a head for gluing biscuit slots, another for $\frac{1}{2}$ " dovetails, and a pinpoint head for tight spots. But this kit's real strength is its five dowel heads, one each for $\frac{1}{4}$ ", $\frac{5}{16}$ ", $\frac{3}{8}$ ", $\frac{7}{16}$ ", and $\frac{1}{2}$ " dowels. Simply plunge the right sized dowel head in the hole and squeeze the bottle as you draw it out of the hole: The clearance between the wall and head automatically meters the correct amount of glue.

By happy coincidence, the heads fit perfectly on the typical store-bought glue bottle, and saved us the inconvenience of refilling the bottle that came with the kit. (We fill that bottle with water and use it to flush the heads clean of glue after use.)

Glue Spreader Set, \$15.

600-PSI INJECTOR PUTS GLUE WHERE NOTHING ELSE CAN



Sometimes, such as when repairing the rungs or backsplats on a chair, you need a way to get glue into a joint that's already assembled. We've tried a number of medical syringes and those little accordionlike injectors with limited success—they're difficult to fill and require a lot of pressure to get a small amount of glue out. But this high-quality, high-pressure glue injector impressed even the most skeptical on our staff.

To use it, drill a 1/16" hole into the joint to be repaired, insert the injector's durable brass tip into the hole, and push the plunger to drive glue into the hole at up to 600 psi. The injector fills easily (suck glue in through the brass tip), holds enough glue to eliminate frequent refilling, and cleans painlessly—simply squirt the remaining glue back into the bottle, then draw in and eject clean water a few times.

High-pressure glue injector, \$26.

POINT-AND-SHOOT EPOXY WITH NO MEASURING, NO MIXING



Two-part epoxy can be mighty handy to have around the shop for joining dissimilar materials, such as metal to wood, or whenever you need a gap-filling adhesive. But this versatile adhesive has its own two-part problem: namely, metering out equal parts of resin and hardener, and mixing them thoroughly.

No more. When you pull the trigger on System Three's Goof-Proof dispenser, it doles out equal amounts of both components, blends them automatically in a disposable mixing tip, and then deposits the epoxy on your workpiece with pinpoint accuracy. The next time you need epoxy, simply snap off and discard the mixing tip (now filled with a half-gram or so of hardened epoxy), install a new mixing tip, and you're ready to roll. For general woodworking, System Three's 15-minute epoxy provides about the right amount of working time.

Goof-Proof epoxy dispensing gun, \$45; extra mixing tips, six for \$8.

(only at Woodworker's Supply)

DE-GLUE GOO DISSOLVES GLUE DRIPS AND SMEARS



Smeared and drips of glue hide like a frightened cat until you apply finish; then they stand out like Santa Claus in summer. De-Glue Goo reveals hidden glue, similar to wiping on mineral spirits, but it goes one step further, dissolving dried water-based glue without affecting the wood or finishes applied after de-gluing. And it won't penetrate into and weaken the joint.

We found nontoxic De-Glue Goo particularly handy when fixing furniture because it easily dissolved the glue from disassembled parts, such as chair rungs or mortise-and-tenon joints, in preparation for regluing. We even de-glued a piece of canvas from a tambour door. The canvas was stubborn at first, but after we covered it with plastic and let it stand overnight, it peeled off without leaving any residue behind.

De-Glue Goo, 8 oz. for \$9.

(not available at Woodworker's Supply)

Sources

- Klingspor's Woodworking Shop, 800/228-0000, woodworkingshop.com
- Woodcraft, 800/225-1153, woodcraft.com
- Woodworker's Supply, 800/321-9841, woodworker.com

Prices may vary by retailer.

finger joints with flair

Sure, they're tough and functional, but finger joints also can add a decorative touch to your projects.

Finger joints give this cherry and maple checkerboard box an eye-catching accent. See the plan on page 98.

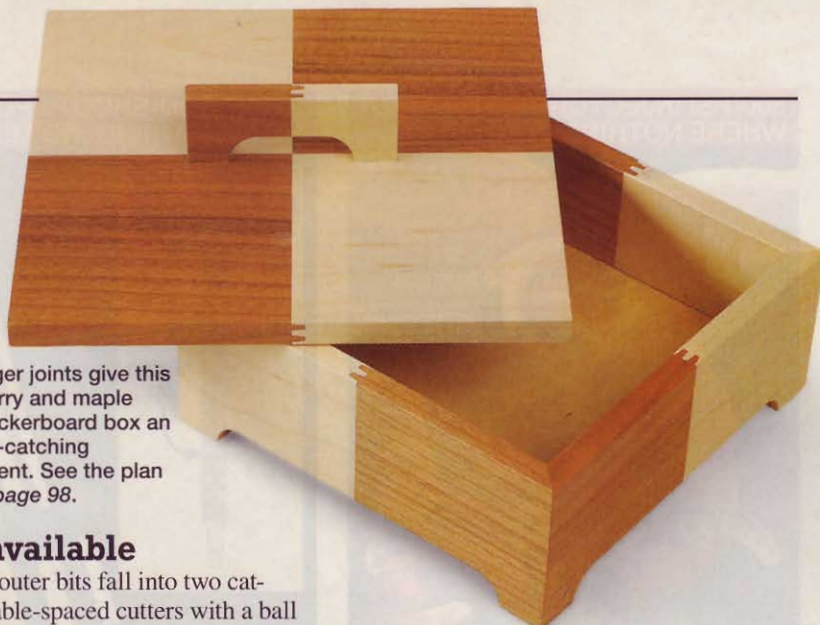

Many woodworkers mistakenly refer to finger joints as "box joints," yet they're not the same. Box joints are normally a row of alternating square openings and "teeth" cut into the ends of two boards. When joined, the two boards form a strong and decorative 90° corner, as in a box, and thus the name.

By contrast, finger joints traditionally refer to the end-to-end mating of short pieces of stock that have several tapered fingers cut into their end grain to gain a longer board. A finger joint can exceed the strength of clear wood because its fingers provide plenty of nonporous grain for gluing. However, finger joints also can add a decorative element when they're used as an alternative to simple edge-joining, as shown in the cherry and maple box above right.

What's available

Finger-joint router bits fall into two categories: variable-spaced cutters with a ball bearing (used for the joints pictured here) and one-piece, eight-finger cutters without a ball bearing. The one-piece type will cut fingers in wood from 1/2" up to 1 1/2" thick, and costs about \$70 from several manufacturers. Adjustable bits cut finger joints of 1/2" to 1 3/8", but by adding or removing shims, you can vary spacing between the fingers for decorative effect. You also can shorten cutting heights by removing cutters. But expect to pay more than \$100 for a variable-spaced cutter. Both types have 1/2" shanks.

Note: *Because finger-joining requires fine adjustments, a plunge router or a table fitted with a router lift works best. For safe operation, finger-joint bits should never be used in a handheld router!*

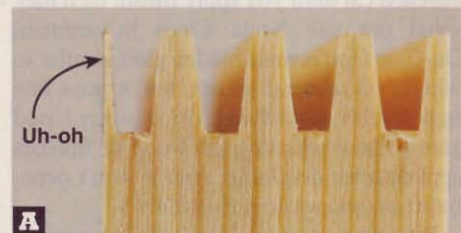

A A strong finger joint should have a full shoulder at top and bottom, not a thin sliver.

Setting up an adjustable bit

Ideally, there should be a full finger on the top and bottom of a finger joint. Avoid a thinly shaved finger, such as shown in **Photo A**, that could break out or protrude when sanding.

To begin, align the fence so that it's parallel to your router table's miter-gauge slot.



B The ball-bearing guide of an adjustable bit must be flush with the router fence.

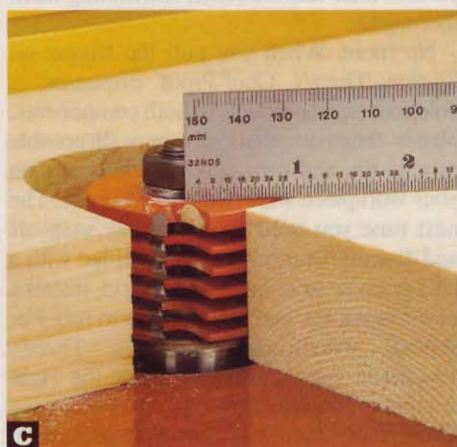

C The large abetting head cutter is the height reference in an adjustable bit.

Then, using a steel rule, make sure to flush the fence with the ball-bearing guide, as shown in **Photo B**.

Next, set the bit height according to the thickness of your workpiece, with the abetting edge cutter (the thickest one) set to cut into the topmost surface. As shown in **Photo C**, the bit is set for a cut in 1 3/8"-thick stock, and the abetting edge cutter is aligned with the top edge of the wood. **Photo D** shows it set for 3/4" stock, with the thick cutter in place lower in the stack. (Be sure that all the stock to be finger-joined, as well as test scrap, measures exactly the same thickness and that the faces and edges are square to each other.)

Aligning a one-piece bit

Because all finger cutters on a one-piece bit are the same thickness, you create a reference point by inserting the bit in your unplugged router; then rotate it until the cutting edge with the highest finger faces you;



D For end-grain cuts, mount an auxiliary face on your miter gauge. Note that the abetting head cutter is now set for cutting thin stock.

continued on page 98

just-right joinery

and using a permanent, felt-tip pen, mark the third finger down, as in **Photo E**. This cutter becomes your reference for the joints.

Next, align the fence parallel to your router table's miter-gauge slot and set far enough back to get a cut as deep as the full bit profile. To set the router-bit height, pencil a centerline along the edge of a scrap piece of wood the same thickness as your workpiece. With the still-unplugged router and bit in your router table, adjust its height until the point-of-reference finger aligns with the centerline on the scrap stock, as shown in **Photo F**.

Once you have the bit aligned, test the fence position with a cut into scrap stock. If the fingers do not contact the exit side of the fence, decrease the depth of cut by moving the fence toward you. If the workpiece fingers contact the fence, but are not smooth and rounded on their ends, you need to increase the cutting depth by moving the fence away from you.

Cutting finger joints

Now that your bit is aligned, cut two pieces of scrap stock, flip one piece over, and fit together the finger-jointed edges. If the faces don't align flush, adjust the bit's height

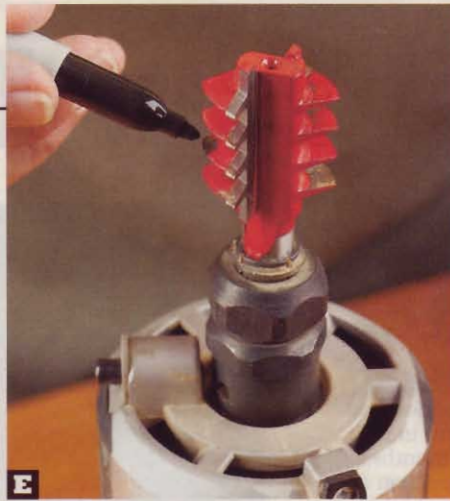

E With a fixed bit, you must mark a reference point before setting bit height.

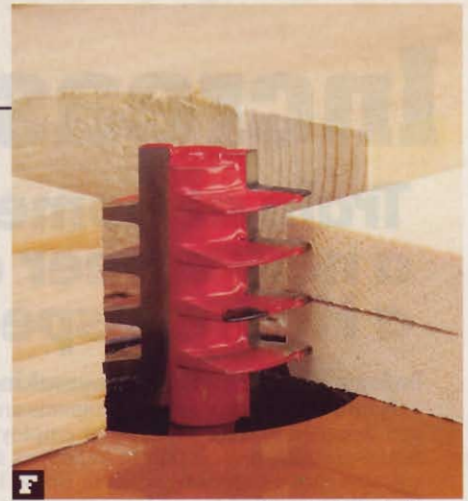

F The marked reference cutter of a fixed bit should align with the center of the stock.

either up or down by one-half the misalignment thickness.

In the example, **Photo G**, the faces misalign by about $\frac{1}{16}$ ". So, we lowered the bit by $\frac{1}{32}$ ". If, on the other hand, the stock on the right side was $\frac{1}{16}$ " too high, we would raise the bit $\frac{1}{32}$ ".

To cut the workpieces for a finger-jointed edge-to-edge glue-up, place the edge grain of the workpieces firmly against the fence, and, using a pushstick, move the wood from right to left across the bit. To join them, flip one over end-to-end. If they fit, as in the end-grain example in **Photo H**, begin gluing.

TIP: With a small brush, apply glue evenly to all cut surfaces of only one of the workpieces to be joined. Applying glue to both pieces just creates excess squeeze-out.

For end-to-end finger joints, attach an auxiliary wooden face to your miter gauge. Make sure that the end against the fence contacts it without interfering with a smooth pass through the bit. Doing this prevents end-grain chipping upon exiting the cut.

Make the cut by holding the workpiece with the good face up firmly against the auxiliary face with one end butted against the router fence, as seen in **Photo D**. Then slowly push the miter gauge and workpiece through the cut. To cut the mating piece, place its good face down and repeat.

Note: From our experience in making finger joints in the *WOOD* magazine shop, you'll probably have to do some light sanding to get the surfaces completely smooth no matter how accurate your settings. Also, have plenty of scrapwood on hand for the setup process.

FINGER-JOINED BOX EXPLODED VIEW

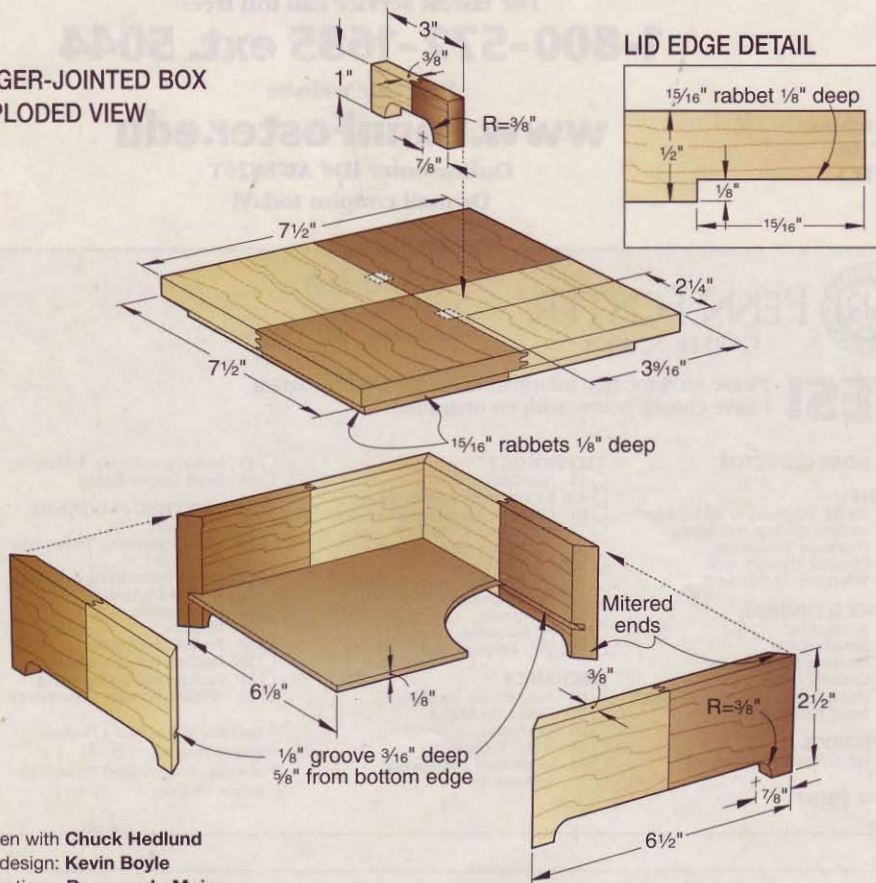

Written with **Chuck Hedlund**
Box design: **Kevin Boyle**
Illustrations: **Roxanne LeMoine**

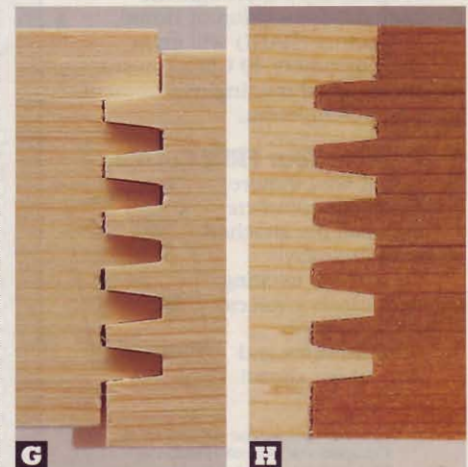

G This joint is misaligned by $\frac{1}{16}$ ", so the bit must be lowered $\frac{1}{32}$ ".

H A perfectly aligned finger joint in $1\frac{3}{8}$ "-thick stock made with an adjustable bit.

from trees to turning blanks

If a tree falls in the forest (or your neighborhood), can you salvage it for turning stock? Here we'll show you how to make quality bowl blanks from a promising log.

What woodturner can drive by a downed tree without thinking, "Hmmm, turning stock?" In this article you'll learn how to cut up and preserve such finds for bowl blanks.

While experienced turners use features such as knots and eccentric growth rings of branches to great advantage, those features can cause blanks and finished turnings to crack or warp excessively. So when selecting wood for turning blanks, avoid limb wood and look instead for trunk logs with minimal knots.

Because the ends of a log start to dry immediately after cutting, seal them right



away to avoid checking. Use a commercial green-wood sealer. (Available from Packard Woodworks. Call 800/683-8876, or go to packardwoodworks.com.) These sealers clean up with water, dry clear, and are superior to paraffin, which can flake off, and paint, which may require several coats for a good seal.

If there is checking on an old unsealed end, make a fresh crosscut to expose an unchecked surface and seal it immediately. Leave the logs in long yet manageable lengths until you are ready to cut them into turning blanks. This limits potential checking (and waste) to just the two ends

of the log rather than both ends of multiple blank-length sections.

Leave tight bark in place. Bark slows moisture loss, helps prevent checking, and leaves the option of using the stock for a natural-edge vessel.

When ready to cut blanks, saw the log into sections about 4" longer than its diameter. This way, if you find any checking after sealing and storing the blank, you'll have ample stock to trim from both ends, exposing check-free surfaces.

When chainsawing a log section lengthwise to form bowl blanks, lay it on its side and support it to prevent rolling. Cut along the grain, as shown *above*. Do not stand the section on its end and cut across the end grain. Doing that takes longer and can overheat and dull the chain.

At the center of a log is the original tree stem, called the pith, surrounded by a zone of very unstable wood. You'll usually be able to recognize this unstable zone by a change in wood-grain color. The size of this zone varies more with wood species than log diameter. Because this unstable wood may cause uneven drying and splitting, remove it. When slicing log sections with a small-diameter unstable zone (1" or less) into turning blanks, make your cut through the pith. For log sections with a larger-diameter zone, remove additional wood adjacent to the pith, as shown in **Photo A**. To guide you when removing the unstable zone from a log section of irregular shape, draw potential bowl shapes around the pith, as shown in **Photo B**.

Continued on page 104

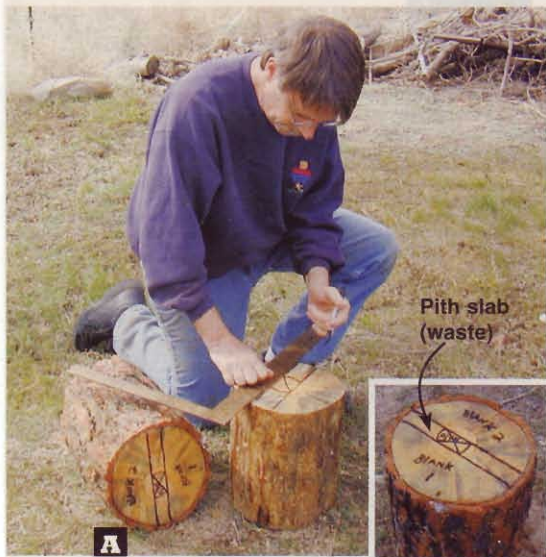

A To remove the pith and a large-diameter unstable zone around it, draw lines with a permanent marker to guide your cuts. The slab marked here is about 1 1/4" wide.

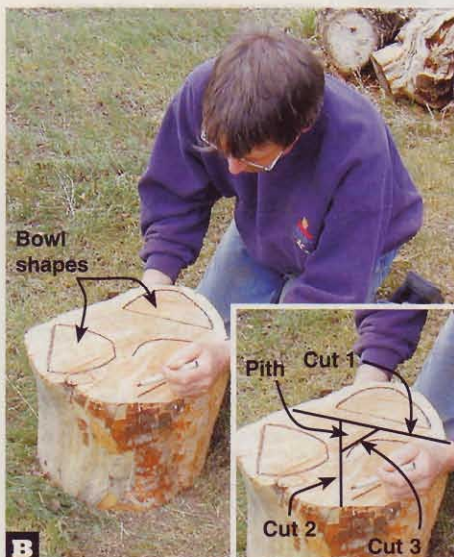

B Irregular-shape logs often yield more than two bowl blanks. It is helpful to draw potential bowl shapes arrayed around the pith before slicing the log into blanks.

Warm to the comfort of radiant heat

RADIANT

Floor Company

Efficient, Quiet, Reliable

It's never been easier to do it yourself

compatible
with any fuel source:

- GAS, PROPANE
- SOLAR, OIL, WOOD
- ELECTRIC,
- GEOTHERMAL



VISIT OUR WEBSITE
CALL FOR A FREE QUOTE
www.radiantcompany.com
Barton, Vermont

(toll free) 1.866.WARM-TOES (927.6863)

> What Size? > How Many? > How Much?

Get It Right The First Time!

PROJECTCALC® PLUS

DO-IT-YOURSELF PROJECT CALCULATOR



Painting

Easily determine Pints, Quarts and Gallons of Paint required for an area, or an area of coverage per gallon.



Wallpaper

Simple keystrokes calculate Wall-paper coverage by area or per roll.

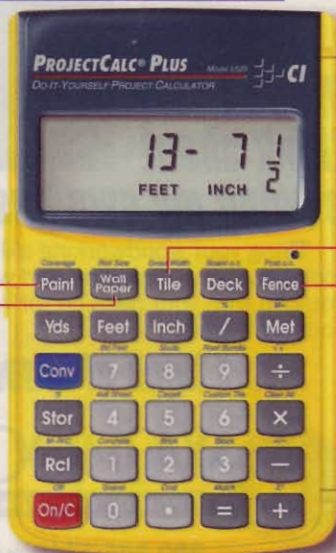

Tiles/Blocks

Quickly find the number of standard or custom Tiles, including the Grout, to cover any area.



Fences/Decks

Use built-in functions to calculate the number of Boards and Rails needed, plus spacing for decks and fences.

Available at Home Centers and Hardware Stores everywhere.

Design, apply, install and finish your home improvement projects with precision and confidence, just like the Pros. Work in Feet-Inch-Fractions, Yards and Meters, including Square and Cubic formats. Use dedicated function keys to quickly and easily

find the amount of material required for common home and building projects — Painting, Wallcovering, Tile, Decks, Fences, Carpet, Gravel, Concrete, Roof Bundles, Blocks, Bricks and more. Instantly calculate costs. **Save materials, time and money!**

CALCULATED INDUSTRIES
www.calculated.com

Call 1-800-854-8075 for the nearest dealer.

Promo Code: WD-206

pros know

Not all log sections must be sliced lengthwise to make bowl blanks. You can leave some log sections whole for turning end-grain bowls, which allows you to get the largest possible bowl from a given diameter log. Be warned, end grain is more difficult to turn than face grain, and end-grain bowls have a greater tendency to crack than face-grain bowls.

Seal the end grain of blanks, as shown in **Photo C**. If the wood is particularly prone to drying stress, such as some fruitwoods, coat the entire piece. When the sealer dries, mark each blank, as shown in **Photo D**. Because the sealer leaves a waxy surface, mark blanks that will be completely coated before applying the sealer. Store blanks off the ground in a dry, well-ventilated area.



C Apply sealer to the blank ends with an inexpensive 3" brush. When processing large quantities of stock at the same time, speed the task by using a paint roller.

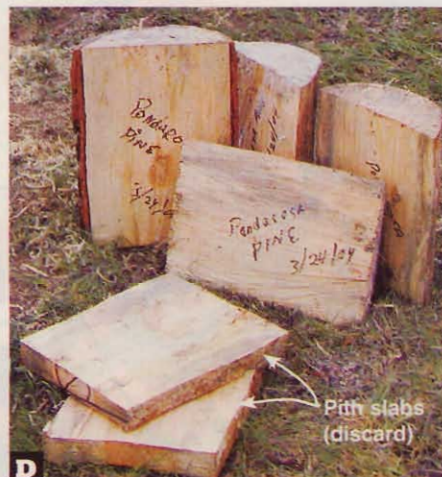

D When the sealer dries, use a permanent marker to label each bowl blank on an uncoated surface, identifying the species and the date it was prepared.

Written by **Phil Brennon**
Photographs: **Kara Brennon**

triple-treat photo frame

Turn a few scraps, a bit of acrylic, and an hour of shop time into a keepsake for family or friends.



1 Cut a piece of $\frac{3}{8}$ " stock (we chose curly maple) to $4\frac{1}{2} \times 11\frac{3}{8}$ " to form the picture holder (A). From $\frac{1}{2}$ " stock, cut the base (B) to $1\frac{1}{2} \times 9\frac{1}{4}$ ".

2 Lay out and cut the circular openings in the picture holder using holesaws or an adjustable circle cutter. Rout $\frac{1}{8}$ " coves around each opening on the front face. Then rout $\frac{1}{4}$ "-wide rabbets $\frac{1}{16}$ " deep on the back face of each opening.

3 To create the surround (C, D), start with a $\frac{3}{4} \times 2 \times 18$ " blank. (We used walnut.) Rout a $\frac{1}{8}$ " cove on each upper edge of the blank. Cut a $\frac{3}{16} \times \frac{1}{2}$ " rabbet along the lower edges of the blank, where shown in Drawing 1a. Then rip $\frac{3}{8}$ "-wide strips from each edge of the blank.

4 Now miter-cut the surround pieces to length, and dry-assemble them to check the fit.

5 Sand all parts to 220 grit. Then glue the surround pieces (C, D) to the picture holder (A). Glue the base (B) to the back side of the picture holder.

Continued on page 109

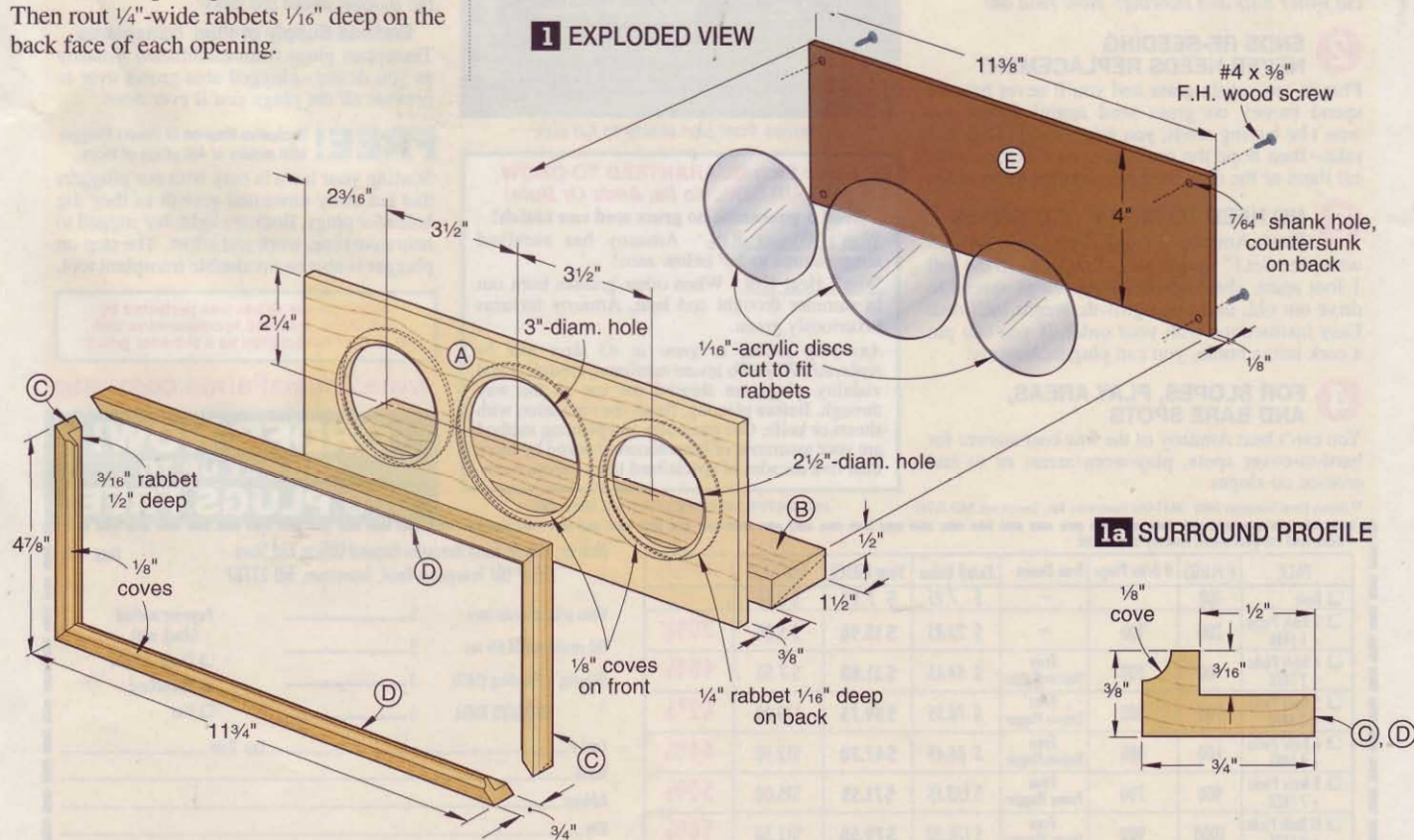

scrapwood projects

- 6** Cut the back (E) to size from $\frac{1}{8}$ " hardboard, test-fit it in the frame, and drill mounting holes. Set the back aside.
- 7** Bevel the bottom edge of the assembled frame, as shown in **Drawing 2** and **Photo A**. Sand the bevel to 220-grit, and finish the frame with two coats of satin polyurethane.
- 8** While the finish dries, cut three acrylic lenses to fit in the rabbeted openings in the picture holder. Now cut three favorite photos to size using the lenses as guides. Slip them into place in the frame, install the back, and admire your photos. ♣

Project Design: **Jeff Mertz**
 Illustrations: **Mike Mittermeier**

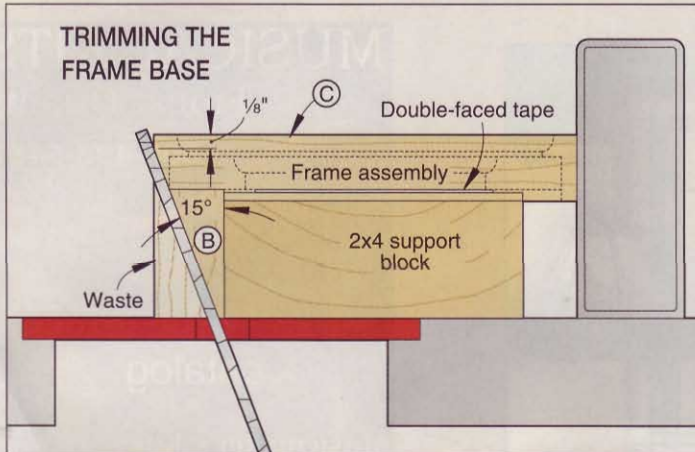

Adhere the assembled frame to a scrap of 2x4 stock using double-faced tape, and then bevel the base at the tablesaw.

NEW!

Easy Dovetails!



\$299
est. street

LEIGH'S NEW 16" DOVETAIL JIG

- through, half-blind and sliding dovetails
- fully adjustable spacing of pins and tails
- 16" capacity
- includes 3 cutters and one guidebush

LEIGH
Joining Tradition With Today

www.D1600.com
800-663-8932

Design Breakthrough!

It's the ultimate **workbench!**
 It's a **downdraft table!**
 It's a complete **air filtration system!**



Deluxe + 30" x 77"

- Generous Maple Worktops
- Powerful 1600, 2100, or NEW 2550 CFM Motor
- GFI Convenience Outlet
- Three Stage Filtering to 0.5 Micron



Ultra Grand 33" x 95"

Call now to find out
about our Specials

WOODMARK

P.O. Box 211434 • Bedford, TX 76095

1-800-845-4400

Visa • Mastercard • Amex • **FREE CATALOG!**

FEATURED PROJECT



China Cabinet

This traditionally styled mahogany showcase provides ample room for good china, or your finest collectibles. Build just the base for an accommodating buffet.

what's ahead

Your sneak peek at articles in the April/May issue (on sale March 21)

Projects from big to small



Eye-pleasing picture frame

Learn to capture riftsawn stock from common fir when crafting this simple design. See how to accent corners using chamfered buttons.



Tudor birdhouse

Give songbirds something to sing about with this charming design. Easy-to-apply trim and a copper-topped shingled roof lend a distinctive look.

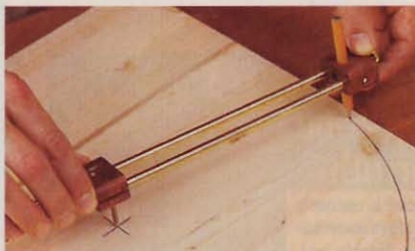

Adjustable beam compass

Scribe arcs or circles from 6" to 29" in diameter with this 16"-long homemade tool, or go up to 63" with a 34"-long version of the same tool.



Double-duty home organizer

Keep notices, bills, envelopes, pens, and other supplies in this compact, full-service center. Personalize it with favorite family photos.



Freestanding planter box

Locate this simply constructed container in front of a window, amid a bed of leafy plants, or anywhere outdoors that deserves a floral boost.

Tools and techniques



HVLP spray systems

Ten turbine-powered models, priced from \$100 to \$800, face off for best-performance and best-value honors.

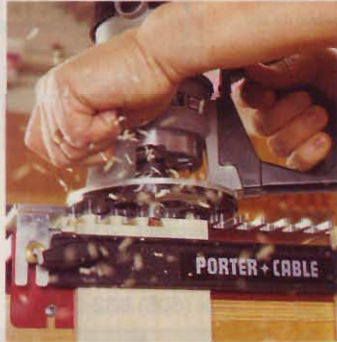

Success with dovetail jigs

Learn an effective way to set up dovetail jigs for well-aligned, snug-fitting joints in drawers, boxes, and chests.



Painless panes

Bypass making individually framed glass door lights with a much easier overlaid framework approach.



Outdoor projects that last

Discover the best woods, glues, hardware, and finishes for projects exposed to Mother Nature's worst.

Better Homes and Gardens WOOD magazine (ISSN-0743-894X) is published seven times a year in February/March, April/May, June/July, September, October, November, and December/January by Meredith Corporation, 1716 Locust St., Des Moines, IA 50309-3023. For subscription questions call 800/374-9663. Outside the U.S., call 515/247-2981. Periodicals postage paid at Des Moines, Iowa, and additional mailing offices. Better Homes and Gardens trademark registered in Canada and Australia. Marca Registrada en Mexico. One-year subscription prices: U.S. and its possessions, \$28; Canada, \$41; other countries, \$49. Canada Post Publications Mail Product Sales Agreement No. 2439. Send address changes to Better Homes and Gardens WOOD magazine, P.O. Box 37439, Boone, IA 50039.