

Better Homes and Gardens®

WOOD®

THE WORLD'S LEADING WOODWORKING MAGAZINE

FEBRUARY 1997 ISSUE NO. 95

RIP FENCE ROUNDUP

WE TEST 21 MODELS
Page 53

MUST-BUILD PROJECTS

- Country buffet
- Circle-top shelf
- Heirloom locomotive
- Bandsawn box
- Turned pocket watch
- Kid's stilts
- Cockatoo bank



Please display until February 11

The New Force of Grizzly!

Z-SERIES

Both Come With A
FREE
Carbide-Tipped
Saw Blade!



G1022Z

INTRODUCTORY PRICE

\$449⁰⁰!

G1023Z

INTRODUCTORY PRICE

\$1095⁰⁰!

We are proud to introduce our Z-SERIES line of woodworking tools. The Z-SERIES represents "top of the line" versions of our standard table saws. We've taken the most sought after features in a tablesaw and incorporated them into the best saws you can find. So, whether you are after the contractor or cabinet-style tablesaw, you owe it to yourself to give us a call— you won't be disappointed!

G1022Z

- Belt driven from the rear-mounted motor to the arbor
- Heavy-duty rip fence with micro-adjustment knob
- Quick-lock fence locks front and back
- All ball bearing mechanism
- Beveled table edge
- 1½ H.P. Single Phase, 110/220V motor
- Sturdy stand
- Precision-ground cast iron table and extensions
- Shipping weight: approx. 270 lbs.



*Purveyors of
Fine Machinery.*

G1023Z

- Front rail-mounted magnetic switch for easy access
- 4" dust port and clean-out
- SHOP FOX® Fence
- New saw guard
- Beveled table edge
- Motor Cover
- T miter slots
- 3 H.P., 220V motor
- Triple V-belt drive
- Shipping weight: approx. 425 lbs.

West of the Mississippi

1 • 800 • 541 • 5537

FAX: 1 • 800 • 225 • 0021

Call
TOLL FREE
24 hours a day!
Ask for your
FREE
'96 catalog!

East of the Mississippi

1 • 800 • 523 • 4777

FAX: 1 • 800 • 438 • 5901

Editor LARRY CLAYTON
Managing Editor JIM HARROLD
Art Director C. L. GATZKE
Design Editor JAMES R. DOWNING
Senior Editor/Features PETER J. STEPHANO
Senior Editor/How-To MARLEN KEMMET
Assistant Managing Editor/Products BILL KRIER
Senior Editor/Special-Interest LARRY JOHNSTON
General-Interest Editor KERRY GIBSON
Associate Art Director PERRY A. McFARLIN
Assistant Design Editor/Project Builder JAN HALE SVEC
Project Builder CHARLES I. HEDLUND
Production/Office Manager MARGARET CLOSNER
Graphic Designer CHERYL A. CIBULA
Administrative Assistant NATALIE COOLEY
Correspondence Writer DON MOSTROM
Contributing Editors KIM DOWNING, DAVE HENDERSON,
LORNA JOHNSON, ROXANNE LeMOINE, BOB McFARLIN

©Copyright Meredith Corporation 1997
All rights reserved. Printed in the U.S.A.

Better Homes and Gardens® WOOD® magazine (ISSN-0743-894X) is published nine times a year in January, February, April, June, August, September, October, November, and December by Meredith Corporation, 1716 Locust St., Des Moines, IA 50309-3023. Periodicals postage paid at Des Moines, Iowa, and additional mailing offices. Better Homes and Gardens trademark registered in Canada and Australia. Marca Registrada en México. ONE-YEAR SUBSCRIPTION PRICES: U.S. and its possessions \$25; Canada, \$36; other countries, \$45. Canadian GST Reg. #BN 12348 2887 RT. POSTMASTER: Send address changes to Better Homes and Gardens WOOD Magazine, P.O. Box 55050, Boulder, CO 80322-5050.

CUSTOMER SERVICE INFORMATION: For service on your magazine subscription including change of address, phone toll-free 800/374-9663. Or, write to Better Homes and Gardens WOOD Magazine, P.O. Box 55050, Boulder, CO 80322-5050. Please enclose your address label from a recent issue.

EDITORIAL INFORMATION: Address letters and questions to THE EDITOR, WOOD Magazine, 1912 Grand Avenue, Des Moines, IA 50309-3379.

MPA

WOOD ONLINE™ at <http://woodmagazine.com>

- Do you have questions on projects, tools, finishes, or woodworking in general? If so, post your questions on our Discussion Group. Most questions are answered within a few days.
- We've added several new shareware programs for your computer to help solve shop problems. You can now download all of the programs for free from our Woodworker's Software Library.
- Use our searchable index to find articles and projects from issue no. 1 to the present.

THE EDITOR'S ANGLE

A creative use for Tired-Out Trees

I don't know about you, but I've always been fascinated by chainsaw carvings. Whenever I watch one quickly taking shape under the skillful hands of the carver, I feel like I'm witnessing a miracle.

Lately, it seems like I've been seeing more of these carvings than ever, mainly used as outdoor sculpture. Recently, on the way home from work, I spotted one in the shape of a turkey in someone's front yard.

Then, at the Iowa State Fair last summer, I was in a large crowd that watched as carver Brian Ruth, of Hartsville, Pennsylvania, transformed a red maple log into a 24" tall roadrunner with his chainsaws.

The most interesting use of chainsaw sculpture I've seen, though, is in the yard of Bill Mays, a retired executive, in suburban Des Moines, Iowa. Bill's odyssey began after the city decided to widen the street adjacent to his lot. According to Bill, as a result of the city installing a retaining wall along his property, several 65- to 80-foot pine trees next to the wall died.

Faced with the prospect of having to saw the trees into firewood, Bill opted for what has turned out to be a traffic-stopping solution. He hired A.J. Lutter, a talented California chainsaw carver, to create five humorous bear sculptures (one is shown in the photo above). Bill tells me that the bears, which A.J. created without drawing pattern lines, have become such a popular tourist attraction that city officials and the police now offer interested parties directions to Bill's lot.

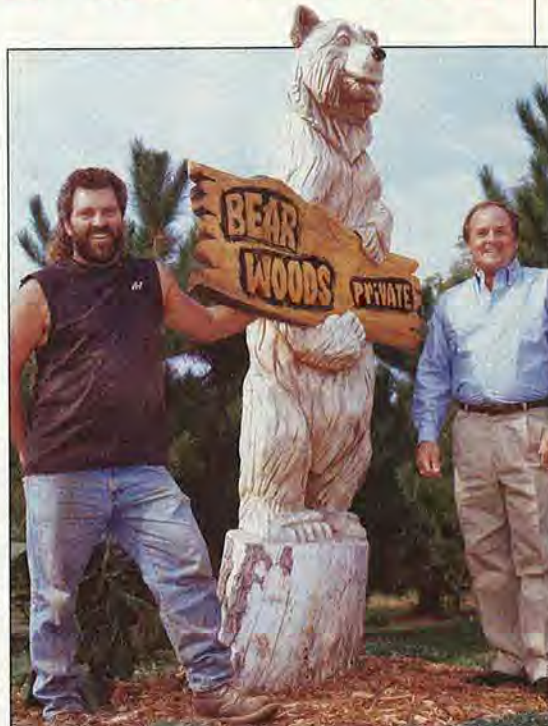

California chainsaw carver A.J. Lutter (left) and Bill Mays standing beside one of the five 10'-tall bear sculptures that grace Bill's property.

Thanks to this conservation-minded property owner's quick thinking, and to one terrific carver, the world is now a more lighthearted, more beautiful place. Thanks guys!

If any of you have a tree on your property that you're thinking about getting rid of, give Bill's solution some thought. To locate chainsaw carvers in your area, first call local chainsaw dealers. If that doesn't produce results, check with the local artists' association. No luck, there? Then write to me, and I will try to help you locate someone who can work on your project. (Note: A.J. charges anywhere from \$100 to \$300 per foot for his carvings.)

Larry Clayton

Better Homes and Gardens®

WOOD®

THE WORLD'S LEADING WOODWORKING MAGAZINE

CONTENTS

Page 27



Page 32



Page 44

27 His sticks are made for walkin'

When Tom Smith retired, he leaned on his woodworking skills for a new life.

42 Half-blind dovetails

Learn how to use your dovetail jig to make tough, tight-fitting joints.

48 A pro's pointers for preparation

Discover the finishing secrets from the WOOD® magazine workshop.

53 Rip fences

Before buying a new tablesaw fence, see our test results inside.

66 Wiring your shop

Let us help you figure the electrical needs for your shop.

70 Salvage: the new way to log old timber

Discover unique sources for old-growth fir, pine, and hardwoods

Woodworking projects in this issue

32 One cool catchall

Bandsaw a fine flip-top box in an evening using contrasting woods.

37 Chubby choo-choo

Make a locomotive for show or play.

44 Cockatoo cache

Build a bird that's really a bank.

50 Arched-top wall shelf

Display collectibles effectively on this mirrored painted project.

60 Country buffet & cupboard

Construct the buffet, then top it with the cupboard from issue 95.

68 Stupendous stilts

Let kids walk tall with this design.



Page 37



Page 60



Page 70

SHORT-SUBJECT FEATURES**1** The Editor's Angle**4** Talking Back**10** Tips From Your Shop (And Ours)**16** Router Review**20** Ask WOOD**24** Great Ideas For Your Shop**74** Yesterday's Tools**78** Products That Perform**100** Pocket Watch**103** Finishing Touches

**THE THINGS YOU BUILD WILL BE
STANDING LONG AFTER YOU DIE.
LEAVE A GOOD MARK.**



© 1997 S&B Power Tool Company

Artists sign the bottom of the canvas. Athletes set records. Yours is a more subtle signature.
But if you do it right, your legacy won't fade. And it will never be broken.

BOSCH



ENGINEERED FOR PERFORMANCE™

www.boschtools.com

GIANT SELECTION BIG SERVICE

Small Prices



Get your hands on some of the best woodworking tools and supplies around. All at the lowest prices everyday. Hundreds of items only available from us.

FREE CATALOG

Call or write us today to receive your FREE catalog of over 900 unique woodworking tools.

ALL GUARANTEED FOR LIFE!

Hartville Tool Company
13163 Market Ave N Dept. BHG297C
Hartville, OH 44632

1-800-345-2396

Circle No. 865

TALKING BACK

Converting decimals to fractions

A part of the course in cabinet-making that I took about 50 years ago included a way of changing decimal measurements into fractions. This technique came to mind when I read "What woodworkers need to know: Calipers" in the September 1996 issue. Here's how it works:

1 Take the decimal measurement reading from your dial caliper (I'll use the .768 from the article) and multiply it by the fractional denominator you're most likely to use (32 for working in $\frac{1}{32}$ " measurements):

$$\begin{array}{r} .768 \\ \times 32 \\ \hline 1536 \\ 2304 \\ \hline 24.576 \end{array}$$

How to reach us

We welcome comments, criticisms, suggestions, and even compliments. And you're sure to hear back from us, perhaps on this page! You can "talk back" by one of several ways:

• **Via mail.** Send your letter to Talking Back, *WOOD*® magazine, 1912 Grand Ave., Des Moines, IA 50309-3379.

• **Via computer.** Send your e-mail to one of these addresses:
CompuServe: 74404,3516
Internet:
74404.3516@compuserve.com

2 Round the answer to the closest whole number, in this case, 25. This becomes the numerator of your fraction. So, .768 roughly equals $\frac{25}{32}$ ".

—Donald Burrows, Euclid, Ohio

An addition to miter jig

I made Tim Hanson's miter jig as shown in the September 1996 Talking Back letter "Improvements on the miter jig." It was quick and easy to make, and the blade guard is an excellent safety feature.

However, I did make one addition to my version. I applied sandpaper to the entire face of each fence, using a spray adhesive applied to the paper. This helps prevent the workpiece from slipping while cutting the miter. And for cutting crown moldings, I add a second piece of sandpaper to the top surface of the jig.

Jim Liberti,
San Jose, Calif.

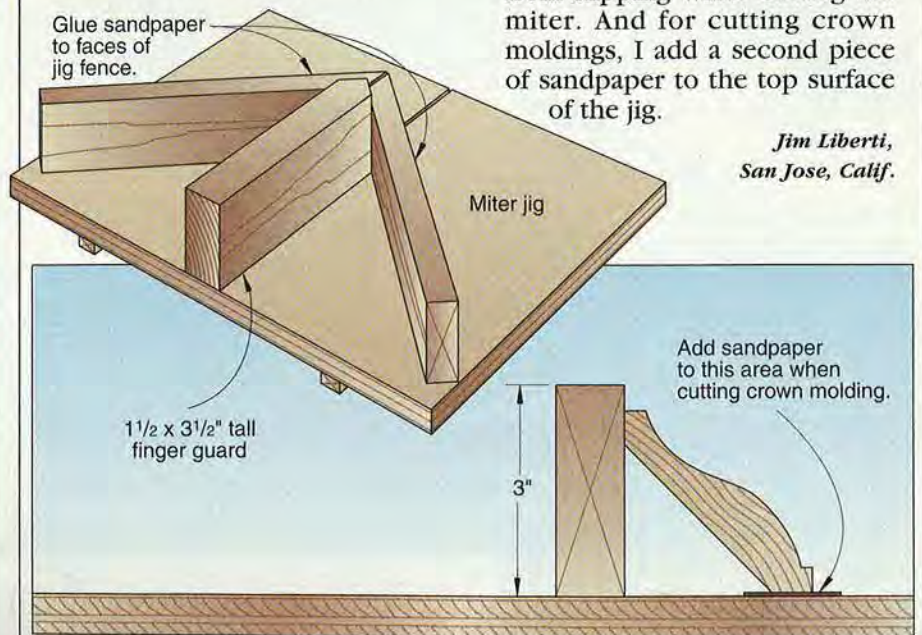

Continued on page 6

Better Homes and Gardens®

WOOD Advertising & Marketing
THE WORLD'S LEADING WOODWORKING MAGAZINE

Publisher **WILLIAM R. REED**
Advertising Director **MARK HAGEN**

Display Advertising: 333 N. Michigan Ave., Suite 1401, Chicago, IL 60601 Phone: 312/853-2890 FAX: 312/580-0113
Eastern Advertising Manager **JAMES N. FORD**
Western Advertising Manager **WILL MURPHY**
Administrative Assistant **JENNIFER HAMMEL**

Direct Response Advertising: 1912 Grand Ave., Des Moines, IA 50309-3379 Phone: 515/284-3785 FAX: 515/284-3343
Direct Response Advertising Manager **LISA WIEMKEN**
Direct Response Advertising **CINDY ANDERSON,**
PATRICK MADDEN

Administrative Assistant **MICHELLE GLOWACKI**
Classified Advertising: Phone: 800/424-3090 FAX: 312/464-0512

Ancillary Sales Director **MAUREEN RUTH**
Marketing Manager **RICK PALLISTER**
Marketing/Ad. Services Supervisor **PAT HENDERSHOTT**

Circulation Director **SUSAN SIDLER**
Associate Circulation Director **KATHI PRIEN**
Business Manager **JANET DONNELLY**
Senior Product Manager **RICK GROW**

Publishing Director **MAX RUNCIMAN**
MEREDITH PUBLISHING GROUP

CHRISTOPHER M. LITTLE, President
BILL MURPHY, Custom Marketing; **JERRY KAPLAN**, Group Sales;
MAX RUNCIMAN, Controller; **BRUCE HESTON**, Manufacturing;
HAL ORINGER, Circulation; **DEAN PIETERS**, Operations

Meredith
CORPORATION

JACK D. REHM, Chairman of the Board
WILLIAM T. KERR, President and Chief Executive Officer
E. T. MEREDITH III, Chairman of the Executive Committee

Super Dado

Super cuts in veneered plywood, melamine, chipboard and solid woods.

SD508
freud[®]

8" SUPER DADO

WITH ANTI-KICKBACK DESIGN

8" DIAMETER
29/32" MAX. CUT

TEETH: 24 OUTSIDE
4 CHIPPERS

ULTIMATE CUTS IN VENEERED PLYWOOD, MELAMINE,
CHIPBOARD AND SOLID WOODS.

Use on hardwood, softwood, plywood, and composition material. Never use chippers alone. Always use both outside blades. Always use safety glasses and guards where possible.

THIS SIDE OUT

When we listen to woodworkers, we understand what you mean — after all, we are woodworkers! You told us you needed a dado to cut plywood, solid wood, hardwood veneered plywood, laminates and melamine chip-free. You told us that it needed to cut precise slots and maintain accuracy. And it especially needed to accommodate today's undersized plywoods.

So we engineered a dado that would not only meet your needs, but would surpass your expectations. First we started with our superior tri-metal brazing to bond a special tooth design to an extra stiff blade body. You wanted dadoes with super smooth flat bottoms so we included 4-wing chippers. You said you hate it when chips build up in the chippers, so we perfected a gullet which ejects the chips. And then we eliminated the hub on the outside blade so chips cannot build up between the blades. The Super Dado will cut all your materials chip-free with a dado so smooth, you'll hate to cover it up.

To make it even better, we added something no other dado manufacturer has...a sixth chipper that is 3/32" thick. That doubles the number of possible slot widths (from 1/4" up to 29/32" wide), and allows you to set the dado to fit today's undersized plywoods. To make it even more flexible, we've included a set of precision steel shims for fine adjustments. Here is a dado that matches the slot width flexibility of an adjustable dado while maintaining the safety and finish of a stacked dado system.

And speaking of safety, we used the same anti-kickback technology associated with our saw blades and router bits. It's the anti-kickback shoulder design that reduces the chance of kickback from over-feeding. This higher level of safety lets you dado with confidence.

Precisely what you need.

High Point, NC 27264 • 800-472-7307

We also packaged all this in a sturdy carrying case. Once you use this new dado, you'll agree that it really is a *Super Dado*.



4 teeth per chipper for super smooth flat bottom dadoes.



Shim set included.



Exclusive 3/32" Chipper lets you perfectly adjust the width of the cut for today's undersized plywood.

TALKING BACK

Continued from page 4

Tips for buying router bits

I enjoyed the new column "Router Bit Review: Lock Miter Bit" in the February 1996 issue. I started checking the cost of these bits and found that the prices range all over the place. Locally, a home improvement store had this style bit for \$129. A mail-order company listed the bit at \$45 (standard) and \$90 for the anti-kickback design shown in the article. Does the anti-kickback feature justify the additional cost, and which bits would you recommend?

—Andy Grintbal, Green Township, N.J.

Andy, for an answer to your question, we contacted Jim Brewer at Freud. Jim stated, "We often find ourselves dealing with the erroneous perception that the anti-kickback feature adds to the cost of a router bit. However, when Freud introduced the anti-kickback technology about 6 years ago, we did not increase the price of our bits.

"The price difference that you see between router bits with the anti-kickback technology and those without generally reflects the difference in the quality of the bit rather than the addition of the anti-kickback feature. The additional cost lies in the use of better-quality and thicker carbide,

together with the better technologies involved in producing the advanced cutting geometry."

When we select a bit for our shop here at WOOD® magazine, we first look at the quality of the cutter in relation to the amount of use we expect the bit to receive. In our December 1994 review of router bits, the two top-rated manufacturers were Freud and CMT. We'd most likely consider buying one of these router bits for situations where we know the bit will receive heavy use. For a bit that we may use on only a few projects, we'd be more likely to consider the less-costly Taiwanese-made bits.

The second area we consider when buying a router bit is the shank size. We recommend you select router bits with a 1/2" shank for cutter profiles that remove a lot of wood (such as a 1/2" cove, 1/2" roundover, or panel-raising bits as shown above.)



The sliver of gray on the Freud bit is all the carbide that can grab the wood should a kickback occur. The larger exposed area of carbide on the bit in front can cause a much harder kickback.

\$50 REBATE.

Contractor's Saw® with any Unifence®, Biesemeyer® Fence or Precision Saw Guide. (Shown here with Biesemeyer Homeshop Fence and accessory table board and legs.)



\$50 REBATE.

14" Band Saw with 3/4 hp Model #28-275
14" Band Saw with 1 hp Model #28-280



\$75 REBATE.

DJ-15 6" Jointer with any motor configuration.

\$100 REBATE.

DJ-20 8" Jointer with any motor configuration.



\$50 REBATE.

Cabinet Shaper Model #43-355

HURRY! OFFER EXPIRES
MARCH 31, 1997

Visit us on the web: <http://www.deltawoodworking.com/delta>

Personalizing the mailbox

My husband Carl decided to build the "First-Class Mailbox" featured in your February 1996 issue, as he thought it would look great on our house. However, to add just the right personal touch, he replaced the word MAIL with our last name—GRICE. And boy, did it ever turn out great! We've received many compliments on it. Thanks for getting us started.

—Allison Grice, Millington, Tenn.

For those of you with names too long to fit on the mailbox, you may want to include your house numbers.



Knobs help protect precious fingers

I just finished building the "Kid's Country Cottage" from the April 1996 issue. And I am astounded at how much fun my 4-year-old daughter Ashley is having with it, even though it's still sitting in the basement waiting for warm weather to arrive.

However, I noticed a couple of things as I watched her play with the cottage. After she would walk through the door, she would try to close it. This resulted in her getting her fingers pinched. To solve this problem, I added a knob on the inside of the door, similar to the knob on the outside. I also added interior knobs on all the windows for the same reason.

I replaced the acrylic in the door and windows with screen material to allow for air circulation. This also lets Ashley and her friends play in the house and keep the insects on the outside. ♣

—Ken Kaplan, Oakridge, N.J.



TODAY, YOU'LL APPRECIATE THE REBATES. LATER ON, YOU'LL APPRECIATE THE QUALITY.

Here's a chance that doesn't come along every day. A chance to put Delta Quality in your shop and get a check in the mail from Delta to boot.

But only until March 31, 1997.

Granted, that rebate check will probably be spent by the time you get around to cashing it. But that new Delta machine will become more valuable each time you flip the switch. And you can take that to the bank.

Call for the name of your nearest participating Delta dealer. Delta International Machinery Corp., 800-438-2486. In Canada, 519-836-2840.

**THE
POWER
OF THE
PROS**

DELTA
WOODWORKING MACHINERY
A Pentair Company

\$25 REBATE.

12" Variable Speed Lathe
Models #46-700/701 with
or without stand.



\$50 REBATE.

15" Planer
with stand
Model #22-675

Delta is proud to nationally fund these two PBS programs for woodworkers. *The New Yankee Workshop* hosted by Norm Abram and *The American Woodshop* with Scott Phillips.



Catalogs for Craftsmen

Select the catalogs you want



1 TOOL CRIB OF THE NORTH—96 pages of the most requested woodworking and power tools from top name manufacturers. FREE



2 ADAMS WOOD PRODUCTS—Wood table legs, bases, and furniture components—no minimum. FREE

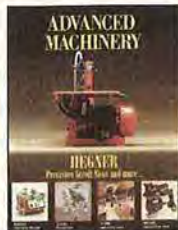

3 ADVANCED MACHINERY—Craft and woodworking catalog of top-quality tools and accessories. HEGNER Scroll Saws, blades and accessories. NEW & FREE!



4 ACCENTS IN PINE—Huge variety of top-quality plans...Over 1500 full-size patterns! Illustrated catalog PLUS sample pattern. \$2.00



5 AMERICAN CLOCKMAKER—High quality clock kits. Solid wood—traditional designs. Movements and accessories available. FREE



6 AMERICAN FURNITURE DESIGN—offers the finest furniture in easy to build plans with detailed instructions! \$3.00



18 CONSTANTINES—120 page catalog features new woods, tools, hardware, finishes, adhesives, books, plans and fabulous new veneers. 6000+ products. Prompt shipping. FREE



14 COUNTRY ACCENTS—Exciting addition to woodworking projects. Pierced metal panels, 100's of designs, sizes, many finishes. Do-it-yourself, too. \$5.00



16 CRAFT PATTERNS—Hundreds of project plans, d-I-y books, videos & CD-ROM at discount prices. \$2.50



15 CRAFTS SUPPLIES—Catalog offers courses for beginners and advanced woodturners. The finest selection of turning tools, supplies and equipment available. Satisfaction guaranteed. FREE



17 ECON ABRASIVES—We make abrasive belts, any size, any grit; plus hundreds of abrasive specialties. FREE



13 FALLS RUN WOOD-CARVING—Wood carving tools that change shape as the contour of the wood dictates. \$2.50



25 HARBOR FREIGHT—Thousands of quality brand name tools for the do-it-yourself or professional. 115 pg. FREE



26 HARTVILLE TOOL—Includes a variety of tools including over 50 we've designed ourselves, not available anywhere else. FREE



27 HIGHLAND HARDWARE—More than just a list of manufacturer's specs, Highland Hardware's giant catalog explains each woodworking tool in detail. FREE



28 HUT PRODUCTS—Pen turning supplies: large selection wood & acetates blanks, mechanisms and HUT finishes. Turning materials. \$1.00



29 INDUSTRIAL ABRASIVES CO.—Full line of quality abrasive products. Belts (any size, any grit), Sheets, Discs and Much More! FREE



30 JOINTHE CABINET MAKER'S SYSTEM VIDEO—Features Dr. Roger Cliffe and Dave Morgan demonstrating all capabilities of this patented system. 28 minutes. \$5.00

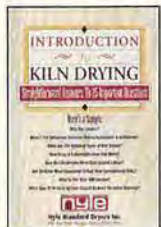

37 NYLE DRY KILNS—Free booklet answers your questions on affordable lumber drying right in your own shop. Comes with complete product literature. FREE



38 PACE EDWARDS CO.—Roll-top cover easily rolls out to keep contents secure and dry-rolls in when not required. Great ideal! FREE



39 PARAGRAPHICS—Now you can engrave too—Ultra High Speed Handpiece with easy to use patterns and video. FREE



40 PENN STATE INDUSTRIES—Unique products, projects and kits for the woodworker. Specializing in dust collection equipment and accessories. FREE



41 PERFORMAX PRODUCTS, INC.—Brochures on complete line of drum sanders for abrasive planing, thickness dimensioning, and fine finishing sanding. FREE



42 PPI—Ironwood Right-Mill—New innovative router milling center. A complete cabinet making and wood milling shop in a single machine. Free catalog and demo video. FREE



49 SPECIALTY FURNITURE DESIGNS—NEW '96 color catalog. Our plans offer a wide range of skill level from beginning child handcraft to advanced adult woodworker \$3.00



50 PATRICK SPIELMAN'S HOME WORKSHOP NEWS—Our 16-page full color bi-monthly publication includes scroll saw patterns, projects, tips, techniques and new monthly trends. Sample copy \$2.00



51 STAR TOOLS—New free catalog features over 44 pages of woodworking tools & accessories. FREE



52 STEELMASTER—Free catalog. Custom built arch style steel buildings. 100% clear-span. Perfect outdoor shop. FREE



53 TERRCO INC.—Produces equipment for all your sign carving & wood engraving needs. FREE



54 TOYS & JOYS—Executive wood toys—patterns and parts, wheels, pegs, for all your toy making needs. \$1.00

from these 60 listings!



7 KREG TOOL COMPANY—Specializes in tools & supplies for pocket hole joinery, KTC high quality router bits and other cabinet & furniture making tools & supplies. 50¢



8 BALDWIN TOY CO.—Plans and kits for collectors' and children's toys. \$3.00



9 BERA—Mechanisms for wooden barrel pens, pencils, rollerballs and fountain pens. \$1.00



10 BOULTER PLYWOOD—The finest cabinet makers select and blend lumber, veneer and plywood. 30 species. FREE



11 CHERRY TREE—Plans, kits, wood & clock parts. Check out our EXCLUSIVE embossed & smooth copper & aluminum sheets & projects. FREE



12 CMT UTENSILI—The original orange router bits, boring bits, and drill bits made in Italy. Full color 116 pages. FREE



19 FURNITURE DESIGNS INC.—Since 1968. Full-size plans for making fine furniture. \$3.00



20 FURNITURE MEDIC—If you like working with wood, turn your hobby into profit. \$1.50



21 GOOSE POND MILL—Exquisite full color catalog of our bird house and bird feeder plans. \$3.00 (refunded with order)



22 GORILLA & SONS—For a great selection of knives and optics. 120 page catalog. FREE



23 GREAT TOOLS DIRECT—This is not your typical all-things-to-all-people catalog. Everything here is an exceptional value. \$1.00



24 GRIZZLY IMPORTS—Free 192 page woodworking catalog! FREE



31 KLOCKIT—Clockmaking kits, plans, quartz and mechanical movements, clock inserts, dials, hands, hardware and more. For all skill levels. Color catalog. FREE



32 LAGUNA TOOLS—We sell band saws, combination machines, band saw blades, saw blades, router bits and shaper cutters. FREE



33 LIGNOMAT—"Mini-Ligno" moisture meter reads surface or core moisture. Works on rough sawn lumber, curved or round pieces. Catalog describes complete line. FREE



34 MINUTEMAN—Discover complete, easy, efficient furniture restoration business ideal for men, women, families. Successful for 28+ years; 3,000+ shops. FREE



35 MLCS LTD—Carbide tipped router bits, raised panel door sets, solid carbide bits, shaper cutters, forstner bits, clamps, tools and supplies. Free shipping. FREE



36 NATIONAL FLOOD INSURANCE PROGRAM—THE NFIP's Never Say Never brochure tells you how to cover yourself from a devastating loss. FREE

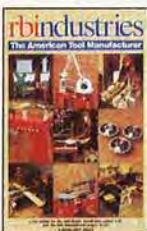

43 RB INDUSTRIES—1997 catalog—HAWK Precision ULTRA scroll saws, Universal wood planers, drum sanders, Panelmaster II, router tables, & more. FREE



44 THE ROUDEBUSH CO.—Buckboard bench kit with real springs, full-size instructions and matching trestle table. 50¢



45 SCM—Specializes in high speed engraving and sandblast-ing equipment. No artistic ability needed. In-house stencil making capability. Engrave on wood, glass, metal, stone. FREE



46 SECO—A fine line of dust collector, shaper, feeder and accessory. Best price and service in USA. FREE



47 TOOLS ON SALE—Division of Seven Corners Hardware Inc. Complete 496 page catalog of the most popular power tool brands at discounted prices. FREE



48 SMITHY—Do your own machining and shop work with a Smithy 3-in-1 Lathe-Mill-Drill. Ideal machine for hobbyists and small businesses. Request your info Pak today! FREE

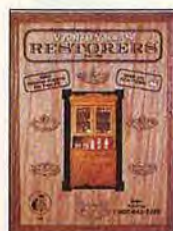

55 VAN DYKE RESTORERS—296 page catalog of furniture hardware, components, carvings, moldings and more! Over 8000 items! \$1.00



56 WILDWOOD DESIGNS—Amazing scrollsaw fretwork patterns and supplies—clock movements, blades, hardwood—48 pages. FREE



57 WOODHAVEN—Uncommon tools. 72 page, 4-color catalog of tools and accessories. \$2.00



58 WOODMARK—Traditional hard maple workbench, complete shop air filtration, and downdraft system for sanding, carving, etc. \$1.00



59 SUNHILL MACHINERY—36 pages feature our full line of quality woodworking machinery & accessories, plus special offers. FREE



60 THE WOODWORKERS' STORE—Over 4,500 products including hardware, wood, tools and know how. Exclusive, hard-to-find specialties! FREE



This symbol represents the quality, service & ironclad guarantee of **CMT Tools**

Win a trip for two to Florida!
See details below



Try the American-made bits from CMT Tools

This special introductory offer lets you experience CMT Tools' quality first hand! You'll get three bits with features like Fatigue-Proof® steel and micrograin carbide cutting edges, all for about half our regular price!

The orange color on router bits is a registered trademark of CMT Tools



1/4" radius Roundover



1/2" diameter Straight



1/2" diameter Flush Trim

800-701
3-Bit Set, 1/4" Shank,
Reg: \$69.60 **Special: \$34.90**

800-702
3-Bit Set, 1/2" Shank,
Reg: \$72.70 **Special: \$36.90**



Dear Friends,

For over five years I've been proud to bring you the finest woodworking tools. During that time, woodworkers across North America have come to recognize the CMT Tools Orange logo as a symbol they can trust.

What does our Orange mean to you? It stands for the highest quality products, it's a reminder of the orange color of our router bits (a registered trademark of CMT Tools) and it represents a solid commitment to service and customer satisfaction.

The CMT Tools Orange is also symbolic of our Florida home. Florida is where we started in 1991 and it's where our bits have been manufactured since early 1996.

We love to show the factory to our friends and customers, so please plan to visit. If you're in the Tampa Bay area just stop by the factory office at 10 am weekdays for a tour.

Be sure to enter our contest for a trip to Florida, I'll look forward to seeing you soon!

Best regards,

Carlo M. Venditto

Carlo M. Venditto, CEO

PS: If I can be of assistance please give me a call, and don't forget our famous guarantee: *If you aren't happy with your purchase, we'll take it back for immediate refund or exchange, period.*

Want to see how the world's best router bits are made? Take a free factory tour!

Stop by the factory office at 306 Mears Blvd., Oldsmar, FL for a tour. Tours are offered weekdays at 10 am, no appointment needed, closed holidays



Win a trip for two to Florida!

One lucky winner and a friend will win three days in Florida! The winner receives airfare, lodging, a day of fishing in the Gulf of Mexico (weather permitting), a superb dinner and of course a factory tour. Just fill in the entry form and return it by April 30, 1997 to CMT Tools, 310 Mears Blvd., Oldsmar, FL 34677

Contest rules:

- No purchase necessary
- Entries must be received by April 30, 1997
- CMT Tools employees & families ineligible.
- Void where prohibited
- Entrants must be at least 18 years old.
- Winner will be drawn at random from all complete entries on May 1, 1997.
- Only official entry forms accepted.
- Entries must include name, address, telephone number and signature.
- Prize includes airfare, lodging, fishing and dinner for two. Winner is responsible for any other expenses.

Official Contest Entry Form

Please print or type, must be completed in full

Name _____

Address _____

City _____

State _____ Zip _____

Daytime Phone: _____

Signature: _____

Come visit us on the Web!

Check out CMT TOOLS' Web site for special deals and lots of information.
<http://cmttools.com/catalog/>
E-Mail: cmttools@packet.net



To order, call toll-free
24-hours a day:

1-800-531-5559

Toll Free FAX: 1-800-870-7702

Free shipping on orders over \$200.00
(\$5.00 shipping & handling for orders under \$200.00)

Dealer inquiries welcome!

Export orders: (813) 891-6160 FAX: (813) 891-6259

CMT TOOLS, 310 Mears Boulevard, Oldsmar, FL 34677



In Canada, call: ToolTrend Ltd. 1-800-387-7005



Can you carve these?

Sure you can, with our exclusive 3D Router Carver™ System



Our free catalog has the complete line of 3D Carving™ Templates plus thousands of fine tools! Call for your copy today!

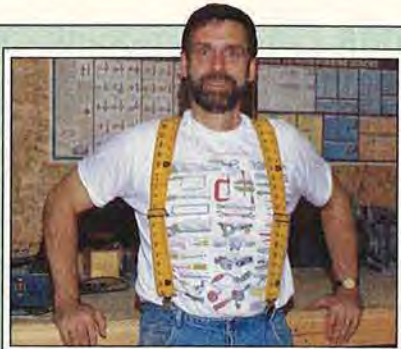

Glen Kraig spends a lot of free time relaxing in his workshop.

Chickens once roosted in Top Shop Tip winner Glen Kraig's workshop. But they've long since flown the coop, and the San Bernardino, California educator has converted his hen house into a spacious workshop that gives him plenty of room to spread his wings.

Glen calls himself an "eclectic" woodworker, producing projects ranging from an inlaid backgammon board to an oak corner cupboard. He developed the tip *right* while building a sofa table. We think it will be a real time saver for anyone who has to cut tapered legs.

To become a prizewinner like Glen, tell us how you solved a particular woodworking problem. We pay \$40 for all tips published. If yours is selected as the Top Shop Tip, you'll win a tool prize valued at \$250 or more and be featured in this column. Send a letter, including your daytime phone number, with a photo or drawing of your idea, to:

**Tips from Your Shop
(And Ours)**

**WOOD® Magazine
1912 Grand Ave.**

Des Moines, IA 50309-3379

We try to publish original shop tips, so please send your idea only to *WOOD* magazine.

Kerry Gibson

GENERAL-INTEREST EDITOR

Use extension blocks to cut tapered legs

After trying to cut tapered table legs by shimming them in my taper jig, I decided there had to be an easier, more accurate way. My solution requires a little more stock, but the results are well worth it.

I start by ripping the legs $\frac{7}{8}$ " longer than finished length (Step 1 of the drawing *below*). Next, I drill a $\frac{1}{8}$ " pilot hole 1" deep centered on the bottom end of each leg (Step 2). After making reference marks on each leg, I trim the legs to finished length (Step 3) and set the waste extension blocks aside.

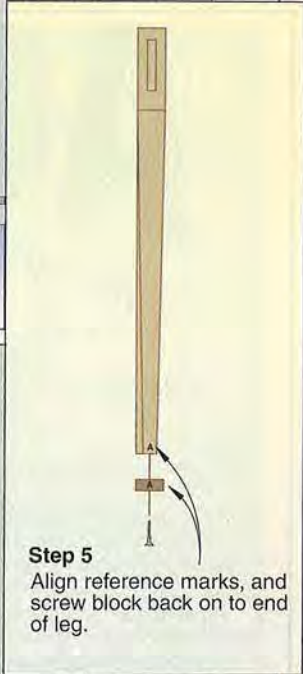
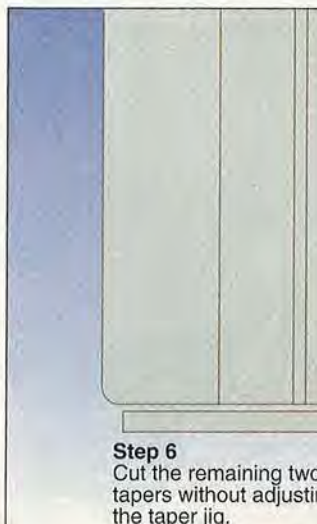
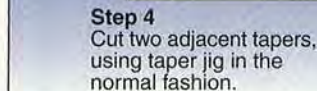
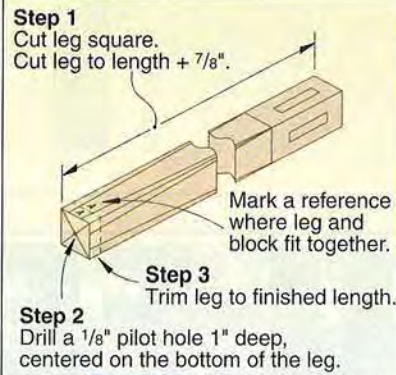

For submitting the Top Shop Tip for this issue, Glen receives a Porter-Cable FN250 16-gauge finish nailer.

Using my tablesaw taper jig, I cut the tapers on two adjacent sides (Step 4). Then, using the reference marks I made earlier, I reattach the extension blocks to the legs with 1" screws (Step 5). The blocks keep the legs properly positioned when making the final two taper cuts (Step 6).

—Glen Kraig, San Bernardino, Calif.



Continued on page 12

Continued from page 11

It's "crown down" when table-routing long workpieces

When molding long workpieces on a router table, the workpiece must be held flat against the table and fence in order for the router bit to cut a consistent, smooth profile. Even with the help of featherboards, bowed workpieces used to cause me fits because they wouldn't lie flat. Narrow stock, which nearly always has some bow in it, was always the worst.

To cut consistent profiles on bowed stock, I examine these workpieces and place them with the bow down for best results. This takes the spring out of the board that occurs with the crown of the bow up. I still use featherboards, but holding the workpiece firmly against the tabletop and fence at the router bit requires much less pressure with the crown facing down.

—Jim Downing, Design Editor,
WOOD magazine

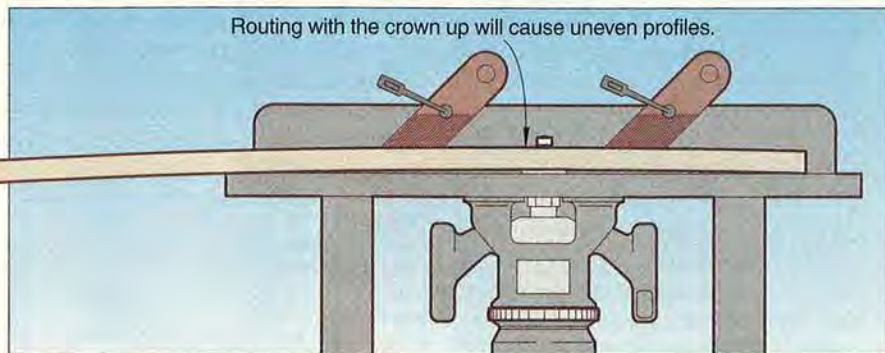
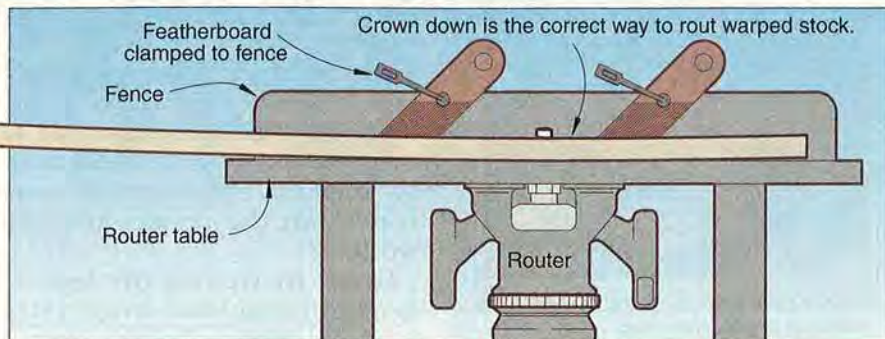

ACCU-FENCE

It's only fitting that we make the best fence for the best saw.

72A SAW

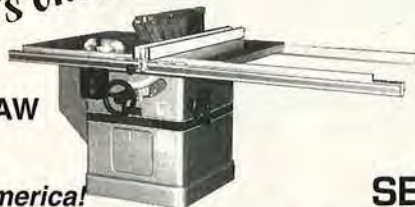

64 SAW



Made in America!

SET IT... LOCK IT!

With the recent changes that have developed in the fence market, Powermatic® set out to design the best fence system available. This seemed only fitting since it is going to be paired with the best table saws!

Powermatic® engineers and designers have developed the premier fence system. . . **The ACCU-FENCE.** The ACCU-FENCE head slide is designed without any "play" as you move the fence into position. The locking mechanism is made from extremely high wear resistant material which gives a positive lock. These important features allow you to **Just Set It and Lock It!** No more trying to find your mark two or three times. You spend your time cutting - not trying to set your fence.

The ACCU-FENCE has laminated covered side panels that provide a super slick surface for your material to

ride against. The important thing to note is how easy it is to change or adjust these side panels. It takes only a few minutes- not an entire day! The ACCU-FENCE side panels do not have exposed mounting screw holes that could catch your material as some fences do.

The ACCU-FENCE slides on Fluoroway, a reinforced Teflon material, that lasts a life time. The ACCU-FENCE is available as standard equipment on Powermatic® table saws. It is also sold as an accessory item that can be mounted on any table saw.

Try the ACCU-FENCE today and notice the difference!

POWERMATIC 
Internet Home Page: <http://www.powermatic.com>



66 SAW

CALL 1-800-248-0144 FOR YOUR NEAREST POWERMATIC DEALER

Quick-Grip clamp helps keep crosscuts square

When an elbow injury made it difficult for me to squarely crosscut long workpieces, I had to find another way to get the job done. My solution was to mount an aux-

iliary fence to my miter gauge, then clamp the workpiece to the fence with a Quick-Grip clamp as shown *below*. The clamp holds the workpiece tightly against the

auxiliary fence, ensuring a square cut. It also provides me with a convenient handle to help push the piece through the saw.

—Dave Rickett, Sylvan Lake, Alberta

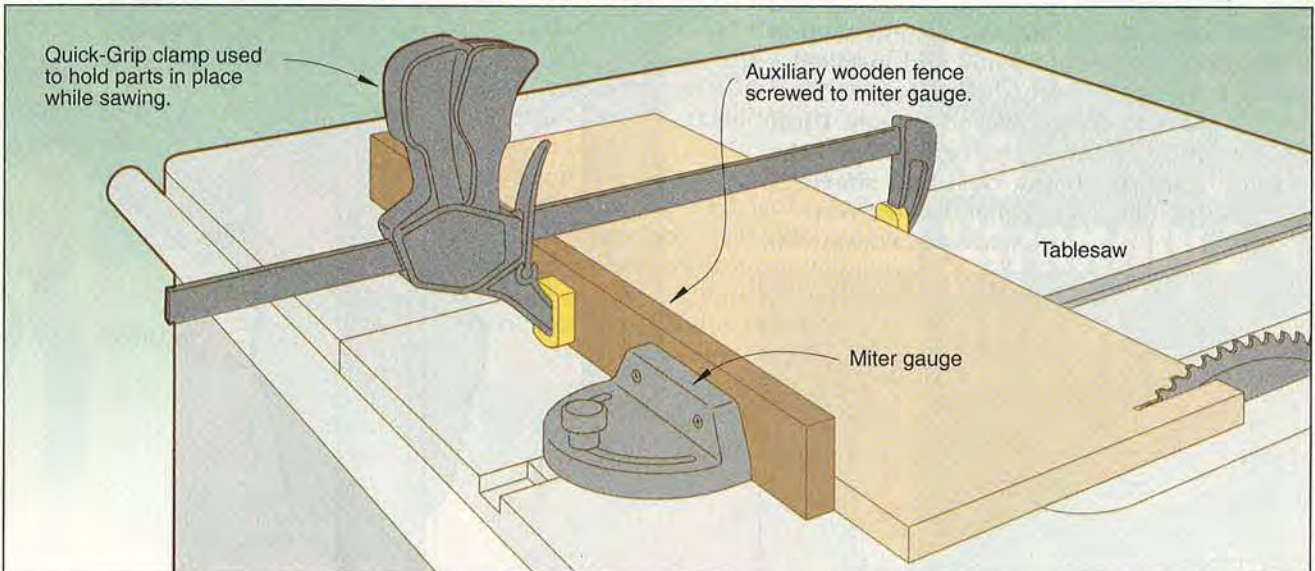

Continued on page 14

The hottest **NEW** woodworking projects...Humidors

The Woodworkers' Store
EXCLUSIVE
THE HUMIDOR COLLECTION



Step-by-step plans with detailed elevation drawings! Plus, our kits include hard-to-find hardware like hygrometers, brass inlays, regulators, specialty hinges —everything except the wood! Ask about Spanish Cedar.

A. TRAVEL HUMIDOR holds five 8½" long 42 ring cigars and Measures 10" x 5½" x 2"
35065 Plan.....\$9.95
35073 Hardware kit.....\$19.95

B. CLASSIC HUMIDOR holds 40 to 50 cigars and measures 10½" x 13½" x 4"
35180 Plan.....\$12.95
19209 Hardware kit.....\$89.95

C. GLASS TOP HUMIDOR holds 80 to 110 cigars and measures 18" x 11½" x 6½".
35081 Plan.....\$14.95
35099 Hardware kit.....\$89.95

Components also sold separately.
Call for a FREE catalog today!

Order today at 1-800-279-4441

Plus, shipping and state tax where applicable

Circle No. 965

Department 63117

Since 1954

The Woodworkers' Store

Hardware, Wood, Tools & Know How

Continued from page 13

Trapdoor lets workbench dust and chips fall free

The trough on my carver's style bench is great for keeping tools close at hand, but it also collects a lot of dust and chips. Instead of building a ramp to sweep waste up and out of the trough, I cut away a short section of the trough's bottom panel and installed a sliding trapdoor, where shown *below*. Now when I want to clean out the trough, I just place a trash can under the bench, open the trapdoor, and push the dust and shavings through the hole. Gravity handles the rest!

—R.B. Himes, Vienna, Ohio

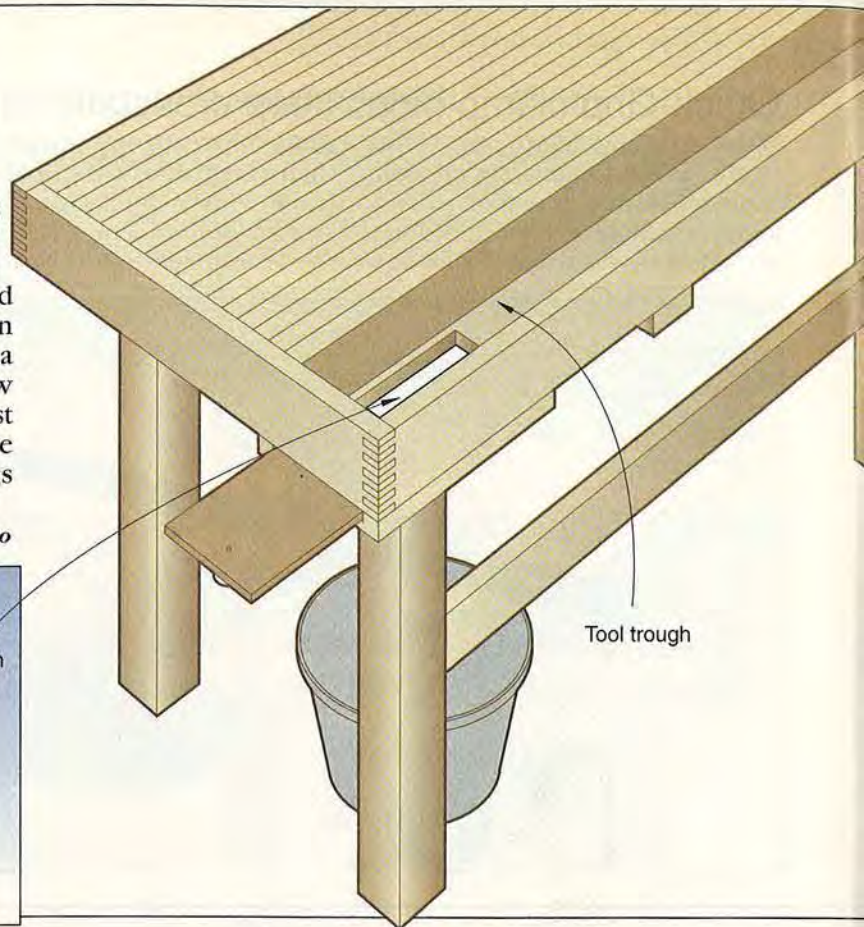
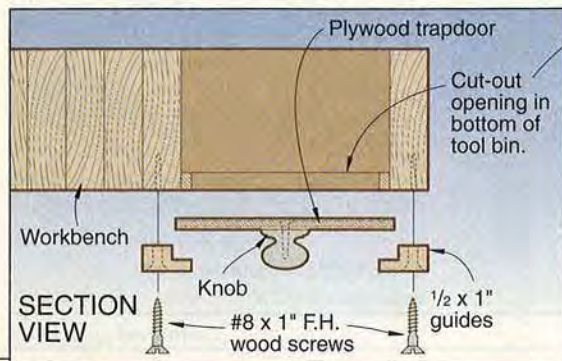

ZSERIES

The New Grizzly G1067Z

Our new G1067Z 7" x 40" Swivel-Head Wood Lathe beats the competition hands-down when it comes to quality and value. Can be used for spindle turning or the headstock and tool rest can be rotated for convenient bowl turning. Automatic speed control has six settings. No more changing belts!

- Cast iron bed and headstock housing
- 13 $\frac{3}{4}$ " swing over bed
- 40" gap between centers
- 1" x 12 T.P.I. RH spindle
- 1 $\frac{1}{2}$ " bore through spindle
- M.T. #2 spindle taper
- 1/2 H.P. TEFC motor, 1725 R.P.M.
- Dual voltage: 110/220v, 12/6 amps
- 6 speeds: 600, 950, 1300, 1700, 1900, and 2100 R.P.M.
- Ball bearings in motor and spindle assemblies
- Push-button ON/OFF switch
- Headstock can be locked at any location on bed
- Approx. shipping weight: 200 lbs.

Headstock swivels 90° & 180° for outboard turning

Quick release levers on both head and tail-stock

Spindle indexes every 15°

Reinforced stand will not flex!



G1067Z
INTRODUCTORY PRICE
\$449⁰⁰!

F.O.B. BELLINGHAM, WA
or WILLIAMSPORT, PA



IMPORTS, INC.

Purveyors of Fine Machinery.

Call TOLL FREE 24 hours a day!

Ask for your FREE 1996 catalog!

Ask for Department # 66D

West of the Mississippi

1 • 800 • 541 • 5537

FAX: 1 • 800 • 225 • 0021

East of the Mississippi

1 • 800 • 523 • 4777

FAX: 1 • 800 • 438 • 5901

Rake out the big pieces

A garden rake isn't standard shop equipment, but it sure comes in handy for separating hose-clogging chunks from a pile of shop debris. I rake through the pile before I vacuum.

—C.J. Jones, Fieldale, Va.



Sift through sawdust with a rake for large pieces of waste before vacuuming floor.

Link clamps to fit work

Band clamps work well on large, or irregular-shaped objects, but as a turner, I often need multiple clamps spread out along the length of a cylinder blank. I found that stainless steel hose clamps are an inexpensive alternative. Available in a variety of sizes, several clamps can be linked end-to-end when I need to encircle larger pieces. Added bonuses are that glue squeeze-out is easily scraped off the clamps and they don't rust.

—Wayne Gaul, Shannon, Ill.

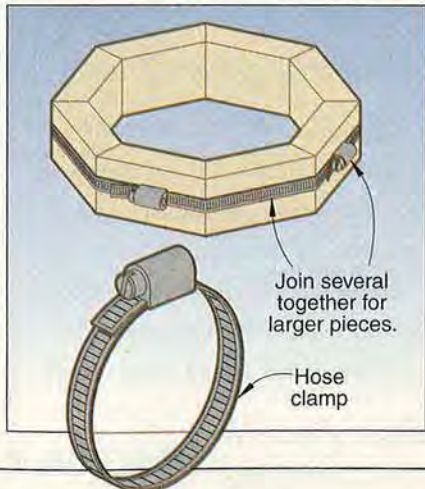

Join several together for larger pieces.

Hose clamp

Glue setscrews to keep tablesaw insert level

My tablesaw's throat insert used to cause me grief. Vibration from the motor loosened the setscrews a bit over time, and the insert dropped down below the table-top. When I tried to rip a board, the bottom edge of the forward end would catch, resulting in an endgrain tearout.

To keep the setscrews firmly in place, I put a dab of Loctite 242 glue on the threads. The glue prevents the setscrews from moving, but a hearty twist with an allen wrench breaks the glue bond.

—R.J. Lemerise, Utica, Mich.

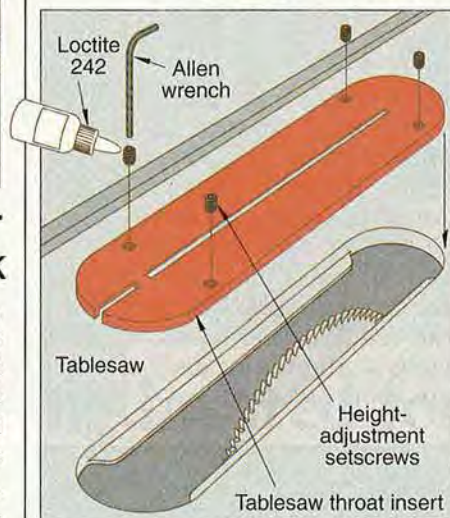

A FEW MORE TIPS FROM OUR WOODWORKING PROS

- When gluing a face-to-face lamination, the layers almost always slip out of alignment as you tighten the clamps. A crosswise clamp, as shown in the photo on page 68, can prevent the problem.
- Need to make a pivoting joint? Install a panhead screw with a washer into one end of a short dowel, as shown in the Pivot Pin Detail drawing on page 45.
- How does the electrical service in your shop rate? Find out how to bring it up to par on page 66. ⚡

The Glue Pros Feel So Strongly About.



Introducing The Glue Anything To Everything Glue.

ProBond™, the super-strong, waterproof glue that can bond virtually anything to anything. Wood, Glass, Ceramics, Metal, Stone, Most Plastics. It's stainable, sandable, and paintable. Requires no mixing, contains no volatile solvents, so it's perfect inside and outside. Pros demand it, so should you.



Vertical raised-panel bits



These cutters have grown increasingly popular in recent years because they don't require a big, variable-speed router (as horizontal raised-panel bits do). But, there are trade-offs that you need to consider.

The pros and cons of vertical raised-panel bits

Because vertical bits don't exceed 1½" in diameter, you can run them at full speed (about 24,000 rpm). So, most single-speed routers with at least 1½ hp will handle them.

You can buy these bits for \$45 to \$60 each—about the same price as or slightly less than horizontal bits. Vertical bits have ½" shanks, and cut the same profiles (ogee, cove, or straight bevel) and the same reveal (about 1½") as full-sized horizontal bits.

As you will see in the next section, vertical bits will cut almost as smoothly as horizontal bits, but only if you take your time and work slowly. You won't find their slow pace a big problem if you're not in a hurry and are making just a few panels.

Finally, vertical bits can only make cuts along straight edges. So, they won't help you make arch-topped panels.

router bit for a consistent cut. It also helps to keep your hands away from the bit.

After building the fence, clamp the guide bar in place, adjusting it so a panel snugly fits between the bar and fence. The panel should slide smoothly, but without any slop. We positioned the bar by placing two pieces of scrap panel stock between the fence and bar as shown in illustration A.

Now, install the bit and adjust its height so that all but ⅛" of its carbide cutting edge is above the table surface. Clamp the fence to the router table so the bit makes a cut about ⅛" deep.

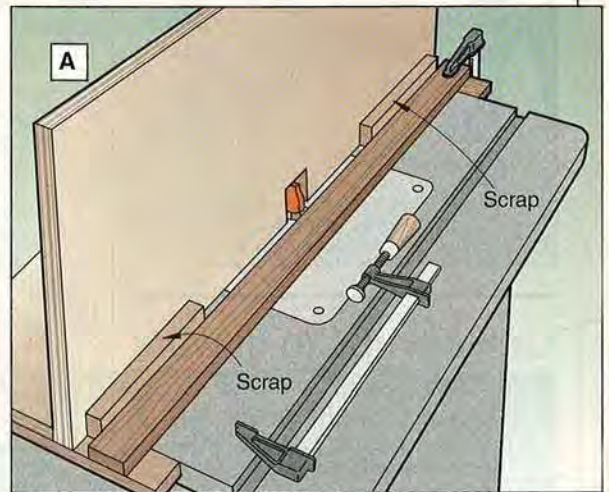

How to get smooth results

Note: Build the frame that the panel will fit into before you start the following procedures. Then, you can test-fit your first panel and be confident that all of your panels will fit in their frame grooves. These bits are designed to be used with ¾"-thick stock.

With vertical panel-raising bits, you stand workpieces on edge as you feed them, so you need a tall router-table fence for support. We've had our best success with the fence shown at right. It has a guide bar that holds the bottom of the panel in firm contact with the

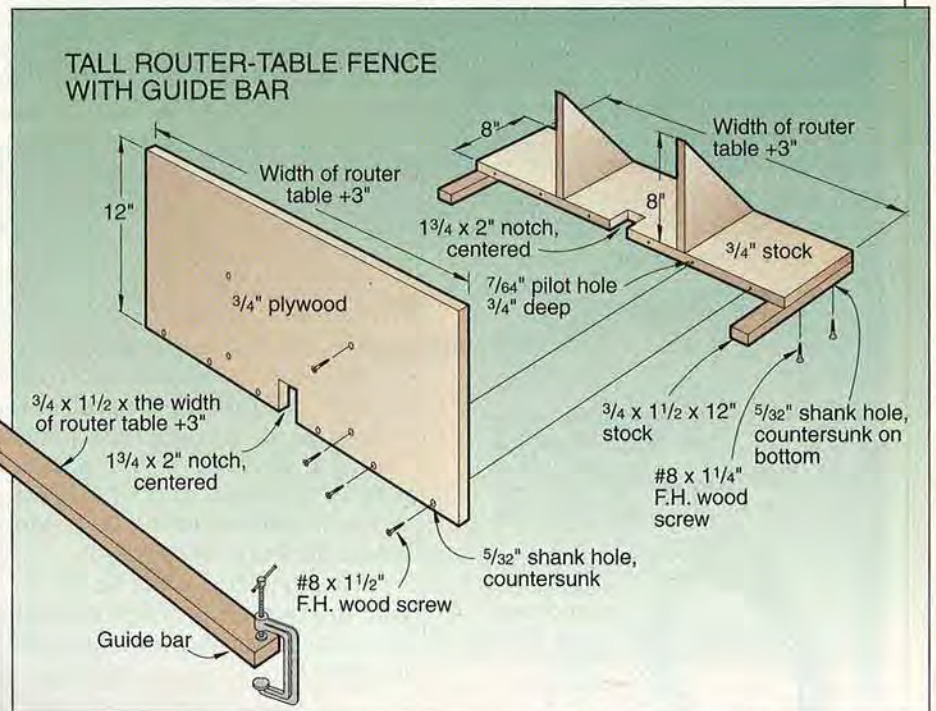

Continued on page 18

A flood isn't the worst thing that can happen to you.



Not being insured for one is.

A flood moves with frightening speed. In minutes, a flood can wash away everything you and your family have spent a lifetime building.

But often the worst isn't the flood. It's finding out, too late, that you're not covered for flood damage.

You're probably not covered.

The truth is, 90% of all natural disasters in this country involve floods. Yet, as many find out too late, most homeowner's insurance policies don't cover flood damage.

Everyone runs the risk of being a flood victim. In fact, between 25%

and 30% of flood insurance claims come from "low risk" areas. It could happen to you.

Give yourself peace of mind.

Fortunately, now you can protect your home and property with flood insurance from the National Flood Insurance Program.

Return the coupon or call your insurance company, agent or this toll-free number: 1-888-CALL FLOOD, extension 148. Act now, since it takes 30 days before your coverage begins. Because with floods, you can never say never.

1-888-CALL FLOOD ext. 148

Please send me information about NFIP.

MAIL TO: FEMA/MSC, PO BOX 1038,
JESSUP, MD 20797-9408

Do you have an insurance agent or company? Yes No

If yes, who is your insurance agent and/or company?

Mag. Issue Date _____

Your Name _____

Address _____

City _____

State _____ Zip _____ Tel. (____) _____



We can't replace your memories, but we can help you build new ones.

NFIP, 500 C Street SW, Washington, D.C. 20472 • TDD #1-800-427-5593 • <http://www.fema.gov/fema/nfip96-31.shm>



FEMA

Continued from page 16

Vertical raised-panel bits

Hold your panel as shown in *illustration B*, and make a cut along the end grain. Hold the top of the panel in solid contact with the fence, being careful not to tip the bottom of the panel into the bit. Feed the workpieces slowly to prevent scalloped cuts and grain tearout (the ends are especially susceptible to tearout). Don't pause as you feed, or the bits will burn. Make the same cut along the opposite end, and then cut the edge-grain sides.

With a pencil, mark the position of the fence on both ends of the table as shown in *illustration C*. These marks will help you reposition the fence for subsequent panels. Then, readjust the fence for another $\frac{1}{16}$ "-deep cut. Make the cuts, remembering to cut the ends first, and again mark the position of the fence. Repeat this procedure until you cut the profile to its final depth.

Depending on the wood, you may be able to take deeper cuts without any problem. But, it's best to err on the side of shallow cuts—even when you get smooth results with deeper cuts. Why? Large chunks of wood can unexpectedly break free from hard, open-grained woods such as red oak, seriously marring the panel.

As you approach the final depth (the panel edges should be about $\frac{1}{4}$ " thick), check the panel for fit into the frame groove according to the guideline in *illustration D*. If you're making multiple panels, clamp some stops onto the table in back of the fence as shown in *illustration E*. These will guarantee cuts of uniform depth on all of your pieces.

The final verdict

If you already own a 3-hp, variable-speed router, or can afford to buy one, go with horizontal bits for panel raising. They don't require any special jigs, but you may need an auxiliary tabletop if your router-table plate doesn't have insert rings for bits of various diameters. And, you'll get better results in much less time.

Vertical raised-panel bits make sense if you need to make a few panels and don't want to spend \$210 or more for a big router. Just remember to be patient and take your time. 🌲

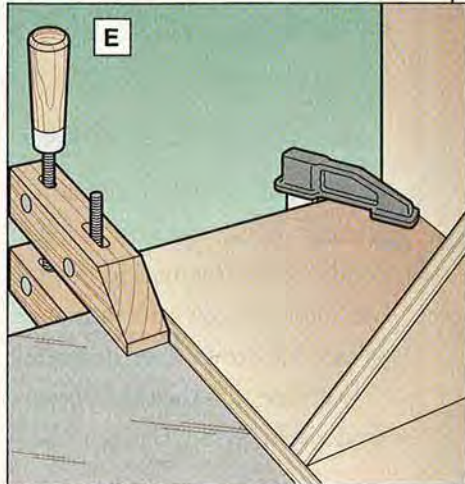
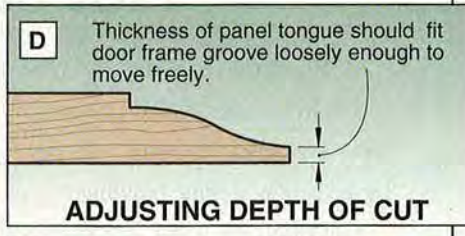
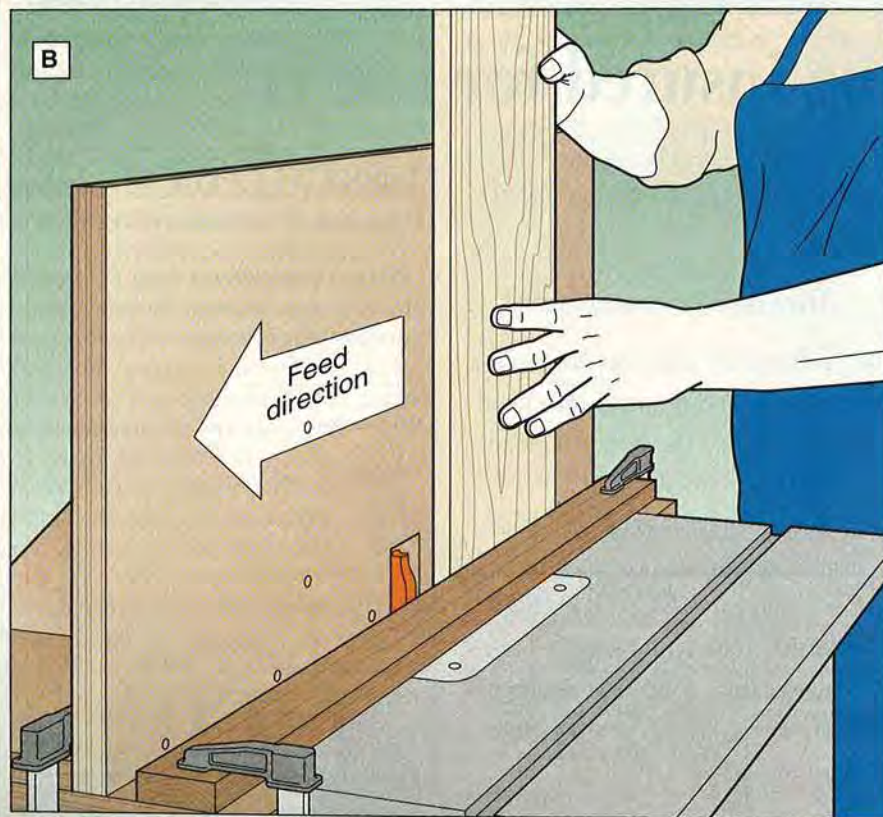
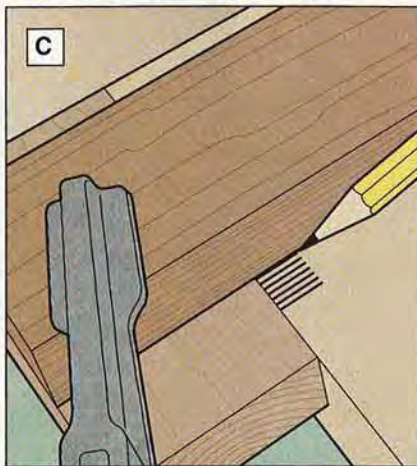

Written by Bill Krier with Jim Downing Illustrations: Kim Downing

FREE Shipping thru 2/28/97
 For INFO OR ORDER CALL 1-800-733-7111
10% to 20% OFF (Listed Items)
SUPER HOLIDAY COMBO SALE

FREE \$45 IN SHARPENING COUPONS
 GOOD ON ALL FORREST OR OTHER MAKES OF CARBIDE
 BLADES OR DADO SETS. Coupons expire 12/31/98.
 Must mention *WOOD* magazine for discounts & coupons with purchase.

BONUS OFFER

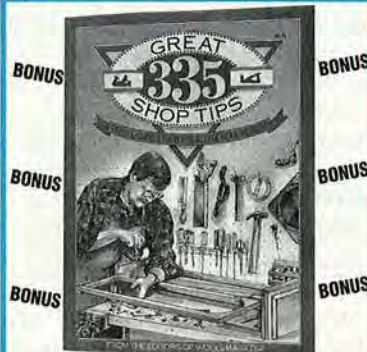

OR 300 Great Shop Tips or Forrest Logo cap FREE with any saw blade or Dado listed & purchased from this ad. You must mention you saw this offer in *WOOD* Magazine, when ordering.
 Offer Expires February 28, 1997.
 One book per order.
ORDER NOW SUPPLIES ARE LIMITED.

BUY 1 BLADE OR DADO AT **10% OFF** SALE PRICE, OR
 BUY 2ND BLADE AT **20% OFF** (EQUAL OR LESSER VALUE)
15% OFF DADO AS SECOND CHOICE.

WOODWORKER II — 6" - 7 1/4" - 14"
 ALL PURPOSE RIP & CROSSCUT

WOODWORKER II	LIST	SALE	10%	20%
12"X40TX1"	\$183	\$129	\$116	\$103
10"X40TX1/8" or 3/32"	\$156	\$119	\$107	\$95
8-1/4"X40TX 3/32"	\$136	\$99	\$89	\$79
8"X40T 3/32"	\$136	\$99	\$89	\$79
7-1/4"X30T	\$112	\$69	\$62	\$55

OTHER SIZES AVAILABLE - 30T LINE ALSO

OUR 30T & 40T OUTPERFORMED (E-EXCELLENT)
 23 other 40T & 50T premium blades both foreign & domestic on Ply, Melamine, MDF and Oak/Rip!
Fine Woodworking Magazine test Oct. 96 page 43



THE ONE BLADE THAT LEAVES A SMOOTH-AS-SANDED SURFACE!

BUY OUR BEST SELLER 10" X 40T FOR ONLY \$107 OR \$95 ON SECOND BLADE.

RECEIVE WITH EVERY FORREST BLADE OR DADO LISTED, 9 SHARPENING COUPONS WORTH \$5.00 EACH!

SAVE ANOTHER **\$45.00** AFTER USING SHARPENING COUPONS

TRY A FORREST CARBIDE BLADE TODAY!

WOODWORKER I - CROSSCUT — 7 1/4" - 14"
 For TABLE and RADIAL SAW - 10% to 20%

	LIST	SALE
14"X60Tx1"	\$224	\$159
12"X60Tx1" or 5/8" 1/8"K	\$198	\$139
10"X60Tx5/8" 3/32"K	\$162	\$129
8-1/4"X60T	\$150	\$109
8"X60T	\$150	\$109
7-1/4"X60T	\$150	\$109

OTHER SIZES AVAILABLE - 7 1/4" - 14"



CHOPMASTER FOR SLIDING COMPOUNDS & MITER SAWS

New specs, 5° Neg. Pts. & flat, runs out less than .002 for perfect, tight, smooth, splinter-free miter joints.

TAKE EXTRA 10% - 20% OFF COMBO SALE!

NEW SIZES AVAILABLE

	LIST	SALE
Delta Sidekick 6-1/2"X40Tx5/8"	\$149	\$89
Sears 8-1/4" & Delta 8-1/4"X60Tx5/8"	\$170	\$99
Hitachi 8-1/2"X60Tx5/8"	\$179	\$109
DeWalt 8-1/2" & Ryobi 8-1/2"X60Tx5/8"	\$179	\$109
Delta 9"X80Tx5/8"	\$204	\$119
Ryobi-Makita & all 10"X80Tx5/8"	\$207	\$129
DeWalt, Makita, B&D, Hitachi 12"X80Tx1"	\$229	\$139
Ryobi-Makita 14"X100Tx1"	\$266	\$179
Hitachi 15"X100Tx1"	\$277	\$189

For good general purpose cuts use Woodworker II 30T & 40T or Woodworker I. Use small stiffener where possible.

DURALINE HI-A/T FOR TABLE & RADIAL SAWS ALL FLAT FACE

5/8" HOLES. Boring up to 1-1/4" \$7.50 extra. Larger holes-time basis. Shipping \$4.50.

	SIZES AVAILABLE	LIST	SALE
Faster feed rates & absolute splinter control.	7-1/4"X60Tx3/32" K	\$149	\$129
Stops splintering on OAK/BIRCH PLY VENEERS & MELAMINE.	8"X80Tx1/8" & 3/32" K	\$202	\$169
	9"X80Tx1/8" & 3/32" K	\$207	\$179
	10"X80Tx1/8" & 3/32" K	\$207	\$159
Other sizes available	12"X80Tx1-1/8"K	\$212	\$181

SPECIAL COMBO SALE
 EXTRA 10%-20% OFF

Above 1" bore standard.
CARBIDE IS THE HARDEST OF THE C-4 GRADES AND 40% STRONGER, NOT WEAKER!
 FOR 50% TO 300% LONGER LIFE.



Standard C-2 Carbide (below, left) and FORREST still sharp Oxidation and Corrosion Resistant Sub-Micron C-4 Carbide (below, right). Each shown after cutting 3,500 feet of MDF. Similar results obtained cutting particle board, melamine, and plywood.



STILL SHARP
 AFTER 3,500 FEET OF CUTTING!

CUTTING PROBLEMS?

Call the factory for **FREE** technical help!!
1-800-733-7111

I just purchased your WOODWORKER II 3/32 blade, and I AM TICKLED PINK with it. My RYOBI BT 3000 saw acts like it had a 3 H.P. motor in it. Cuts so much easier and quieter and smoother. Don't need my jointer or sander now.

P. Rose, PA

After installing your blade and 5 in. stiffener the vibration in my saw went down another 20%. I ran several pieces of hardwood through the saw, both crosscut and ripping, and was amazed at the smoothness. It was like cutting butter, maybe smoother. I have never had a saw blade that cut this smooth.

NEW DELUXE DADO-KING!
 AS LOW AS \$184 NET AFTER USING SHARPENING COUPONS

C-4 Carbide Tips — 4 on each chipper with special negative face hoods.

	LIST	SALE	10%	15%
6" D. 5/8" Bore NEW	\$299	\$269	\$242	\$229
8" D. 5/8" Bore	\$321	\$289	\$260	\$245
10" D. 5/8" & 1" Bore	\$389	\$349	\$314	\$297
12" D. 1" Bore	\$499	\$449	\$404	\$382

(Bore up to 1-1/4" Add \$25 — Plus \$5.50 S&H)

BLADE DAMPENERS-STIFFENERS

FOR BETTER CUTS on all brands of blades, use our large 1/8" DAMPENERS-STIFFENERS against one side.

4"	\$21
5"	\$24
6"	\$25

7" AND LARGER AVAILABLE

REDUCES NOISE 50%-75%

WE RECOMMEND OUR FACTORY SHARPENING as some local sharpening creates problems with MICRO-CHIPPED EDGES reducing blade life & cutting quality. 3-5 DAYS ON THESE AND ALL MAKES OF FLAT FACE & CONCAVE CARBIDE TIP SAWS. Ship via UPS. Typical 10x40T \$17.00, 60T \$19.00. Add return UPS \$5.00, \$1.00 each additional blade.

FOR SPECIAL PRICE COUPONS MENTION *WOOD* MAGAZINE.

PHONE TOLL FREE! 1 (800) 733-7111
 (In NJ: 201-473-5236) FAX: 201-471-3333

Fine American saw making & sharpening since 1946.
 DEALER INQUIRIES WELCOME

Quality is why we're different!



(800) 733-7111 or (201) 473-5236

BUSINESS OPEN ACCOUNTS AVAILABLE



FL, NJ, NY Residents Please Add Sales Tax
 Shipping Charges with book:
 Sawblades \$9; Dado \$10; Stiffener \$2
 SATISFACTION GUARANTEED OR FULL CASH REFUND.

FORREST MANUFACTURING COMPANY, INC. • 461 RIVER ROAD, CLIFTON, NJ 07014 • FAX (201) 471-3333

I want it measured in board feet

Do you have an easy formula for converting lineal feet to board feet?

—Jack Jolley, Bellville, Texas

Here's how to do it, Jack:

1 Multiply the length of the board (in inches) by its average width.

2 Multiply this figure by the thickness of the rough-cut board (4/4=1" rough, or about 3/4" when planed. 5/4 lumber =1.25", or 1 1/8" after planing, etc.).

3 Divide your answer by 144 to obtain the final measurement in board feet.

Here's an example, using a 5/4 thick board 60" long and 4" wide:

$$4" \times 60" = 240 \text{ square inches}$$

$$240 \times 5/4 \text{ (or 1.25)} = 300$$

$$300 \div 144 = 2.08 \text{ board feet}$$

Have a question for our woodworking experts? Here's how to reach us.

No matter how simple or perplexing a woodworking problem you're faced with, we would love to hear from you. We'll do our level best to solve your mystery, and you might even find your question and our reply on this page.

You can reach us by one of several ways:

• **Mail.** Send your letter to Ask WOOD®, 1912 Grand Ave., Des Moines, IA 50309-3379.

• **Via Computer.** Send your e-mail to these addresses:

CompuServe: 74404,3516

Internet: 74404.3516@compuserve.com

A 4/4 board (1" thick rough, about 3/4" thick planed) of the same width and length would be calculated this way:

$$4" \times 60" = 240 \text{ square inches}$$

$$240 \times 4/4 \text{ (or 1.00)} = 240$$

$$240 \div 144 = 1.67 \text{ board feet}$$

Give Yourself Some Breathing Room.

MODEL 8-12
MODEL10-16



*Better Homes and Gardens® WOOD® Magazine (Nov. '95)

JDS AIR-TECH 2000™

Recent medical studies show that breathing wood dust can be hazardous to your health. The JDS AIR-TECH 2000 will dramatically improve the quality of the air in your workshop.

Our model 350 delivers 350 CFM of filtered air. This will clean the air in a 20 x 20 x 8 foot shop six and a half times per hour. For larger areas, our dual speed model 8-12 will deliver 800 or 1,250 CFM of filtered air for only \$495. Our model 10-16 will deliver 1,000 or 1,600 CFM of filtered air for \$695.

The JDS AIR-TECH 2000 systems will remove 99% of dust particles as small as five micron and 80% of the particles as small as one micron.

Our unique design makes both ceiling installation and filter changing quick and easy.

- All components UL Listed
- Lifetime Warranty
- 95% ASHRAE Tested Main Filter
- 30 Day Money Back Guarantee.

\$259.00
Model 350

Another quality product from
Manufactured in the U.S.A.

**JDS
COMPANY**

To place an order or for the dealer nearest you call us toll-free. And give yourself some breathing room.

1-800-382-2637

These tiger stripes aren't in the zoo

I've seen some projects that were built from "Tiger-stripe oak." Can you give me some information on this wood?

—John Evans, Kansas City, Mo.

John, we've seen the term "tiger stripe" used in two different ways when referring to oak. However, both uses refer to a grain pattern in the wood rather than a separate species of oak.

In the first usage, "tiger stripe" becomes interchangeable with the terms "fiddleback" or "curly." In this grain pattern, the annual rings move up and down in relation to the face of the board as the grain runs the length of the board. This results in the grain at the surface of the board alternating between light-reflecting side grain and light-absorbing end grain, creating a striped pattern (see the photo below left).

Some woodworkers also use "tiger stripe" to describe medullary rays that appear on the surface of rift cut oak boards. These rays appear as lighter stripes running across the longitudinal grain of the wood. This type of wood was commonly used in better pieces of Mission-style furniture, and in trimming Craftsman-style houses. See the photo below right for an example of this grain pattern. 🌲

WOODLINE ARIZONA, Inc
P.O. Box 1530 • Payson, AZ 85547
• All Major Credit Cards Accepted
• Shipping is only \$3.75 per order
• 24 hours a day • 7 days a week
1-800-472-6950

Great Router Bits! & Shaper Cutters



One-piece RAIL & STILE CUTTER, raise bit 3/8" to make matching cut. Available in Ogee, Roundover, and Cove & Bead profiles • Great fit! • No changing bits or reversing the pieces.

PANEL RAISER W/ UNDERCUTTER, 3 profiles: Ogee, 15° Face Cut, and Convex avail. Tongue thickness perfectly matches groove in Rail & Stile—everytime!

Best Buy!
BOTH RAIL & STILE CUTTER & PANEL RAISER W/ UNDERCUTTER,
ONLY **\$95.00**
or **\$49.00 ea**

SUPER BUY!
Great sets in attractive wooden boxes! Available in 1/4" and 1/2" shank

- 8 pc. Joint Making Set 2 Straight Bits, 6 Dovetails **\$49.00**
- 6 pc. Roundover Set 1/8", 3/16", 1/4", 5/16", 3/8", 1/2" radius **\$55.00**
- 5 pc. Cove Set 3/16", 1/4", 5/16", 3/8", 1/2" radius **\$49.00**

SUPER SALE!!
Cutters & Bearing Sets (to change depth of cut) Two-Flute Cutters avail. in 1/4" or 1/2" shank. Allen wrench included.

- 5/32" Kerf w/ 3 bearings, cuts slot to fit all biscuit sizes. Sample bag of biscuits incl.
- Rabbeting Bit w/ 4 bearings for rabbets of 1/4", 5/16", 3/8" & 1/2" depth
- 1/4" Kerf Slot Cutter w/4 bearings cut slots 1/4", 5/16", 3/8" & 1/2" depth

Priced at only **\$15.00 ea**
SAVE \$6. **\$39.00 Set of 3**

Best Prices • Same Day Service • Super Selection
32-page Catalog included with every order

Circle No. 1395

ARROW® Introduces The New Improved T50® Staple Gun Tacker!

All Steel Construction
Long-Lasting Reliability
Hard-Driving Power
And Now...

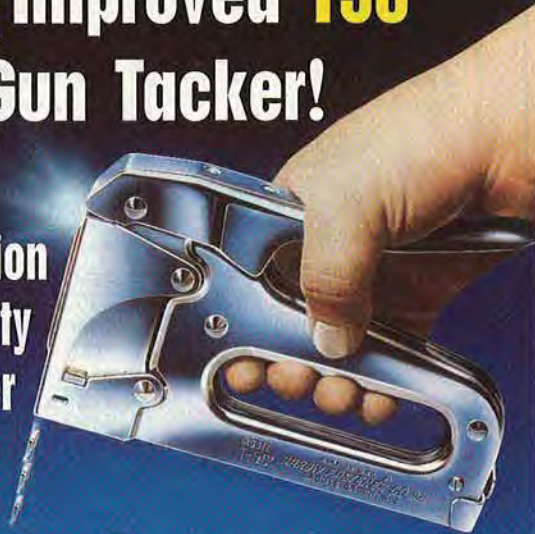

Easier to Squeeze THAN EVER BEFORE!

ARROW's T50P uses 6 different size staples: 1/4", 5/16", 3/8", 1/2", 9/16" and 17/32" Ceiltile.

All ARROW staple guns and staples are built in the USA under the strictest standards of quality assurance. *It's been that way for over 65 years!*

ARROW products are available at home centers, lumber yards, hardware stores and wherever fine tools are sold. *You work hard for your money. So, spend it wisely. The all-steel T50P will last and last and last....*

MADE IN
USA

ARROW FASTENER COMPANY, INC., 271 Mayhill Street, Saddle Brook, N.J. 07663
ARROW FASTENER (U.K.) LTD., 14 Barclay Road, Croydon, Surrey CR0 1JN
JARDEL DISTRIBUTORS, INC., 6505 Metropolitan Blvd. East, Montreal, Quebec H1P 1X9

VALUE ADDED SPECIALS
AT YOUR LOCAL RETAILER

FREE
HEAVY DUTY - DIE CAST - 4 POSITION
UTILITY
KNIFE
WITH BLADE INCLUDED

AT PARTICIPATING STORES • FOR A LIMITED TIME ONLY

OR

ENCLOSED
FREE
WIRING ATTACHMENT

ARROW

© 1996 ARROW FASTENER CO., INC.

100% SATISFACTION GUARANTEED!
***FREE SHIPPING!**
FOR ALL ITEMS SHOWN BELOW!

HARBOR FREIGHT TOOLS



Visit Our Web Site
HARBOR FREIGHT TOOLS
<http://www.harborfreight.com>

CENTRAL MACHINERY

16" SCROLL SAW



- Precision milled 14-1/2" x 8" table tilts 0° to 45°
- Uses pin end blades, 5-1/2" long
- Heavy duty cast iron frame and base reduces vibration • 7/8" blade stroke
- 1/8 HP, 110V, .83 amps
- 1750 SPM blade speed

ITEM 34618-05XA **\$59⁹⁹**

FOOT SWITCH WITH GUARD

Ready to use. Steel housing and 8 ft. cord.

ITEM 00495-65XA **\$9⁹⁹**

CENTRAL MACHINERY

SAVE OVER 30% FROM OUR FALL '96 CATALOG

6" INDUSTRIAL RABBETING JOINTER INCLUDES STAND



- Infeed table size: 22-1/2"
- Outfeed table size: 19-1/2"
- Motor: 1 HP, 110V, 4 amp, 4900 to 5900 RPM cutterhead speed
- Maximum depth of cut: 3/8"

ITEM 30289-55XA **\$199⁹⁹**

REPLACEMENT BLADE SET

ITEM 33271-15XA **\$9⁹⁹**

CHICAGO Electric Power Tools

SAVE 20% FROM OUR FALL '96 CATALOG

TRIM ROUTER



Now you can tackle those jobs that were too fine or exacting for a standard router. This compact router weighs only 4 lbs. for easy operation. Includes a straight and adjusting conductor to assist in trimming and engraving in both straight and circular patterns.

- 1/4" collet
- 30,000 RPM no load speed
- 110V, 3-1/4 maximum amp draw
- 8-1/2" overall length
- 4 lbs. tool weight

ITEM 33833-35XA **\$39⁹⁹**

CENTRAL MACHINERY

10", 2 HP, BENCH TABLE SAW



Die cast aluminum table 25-3/4" x 16", has adjustable 17-7/8" x 2" rip fence and inch/metric scale for precise cutting.

- Maximum depth of cut at 90°: 3-1/8"; at 45°: 2-1/2"
- Blade capacity: 10" with 5/8" arbor
- Miter gauge adjusts 0° - 60° left and right
- Motor: 2 HP, 115V, 60 Hz, 10 amp, 4500 RPM
- Blade sold separately, below
- Shipping weight: 36 lbs.

ITEM 35715-25XA **\$79⁹⁹**

10" 40 TOOTH CARBIDE TIP SAW BLADE

• 5/8" arbor **\$9⁹⁹**
 ITEM 00529-45XA

DELTA
 Delta 36-510

LIMITED QUANTITIES



10" BENCH SAW

Big saw capacity in a portable unit. Easy and safe to use with up-front controls and removable on/off switch. Front and rear locking rip fence and miter gauge maintain full sized accuracy.

- Motor: 13 amps, 115V, 4700 RPM
- 5/8" arbor • Table: 16" x 26"
- Capacity: 3" max. depth, 2-1/2" max. depth at 45°
- Dimensions: 15" x 26" x 19"
- 40 lbs. tool weight

ITEM 35734-45XA **\$109⁹⁹**

HITACHI

7-1/4" CIRCULAR SAW



- 115V, 10 amps, 60 Hz, single phase
- 5500 RPM • Tool weight: 8-3/4 lbs.
- Maximum cutting depth: 2-1/4"

Hitachi C7SC **\$64⁹⁹**

8-1/2" SLIDE COMPOUND MITER SAW

Hitachi C 8FB **\$429⁹⁹**

3/8" 9.6V DRIVER DRILL WITH KEYLESS CHUCK

Hitachi D 10DF2 **\$99⁹⁹**

4" DISC GRINDER

Hitachi G 10SD1S **\$54⁹⁹**
 ITEM 34644-75XA

3/8" 9.6V CORDLESS DRILL WITH KEYLESS CHUCK

Hitachi FDS10DVA **\$99⁹⁹**
 ITEM 34998-65XA

4-1/2" ANGLE GRINDER

Hitachi G125A **\$59⁹⁹**
 ITEM 35015-45XA

9.6 VOLT CORDLESS 1/4" IMPACT DRIVER

Hitachi WH8DC2 **\$139⁹⁹**
 ITEM 35254-25XA

McCULLOCH
 McCulloch 3214



14" GAS POWERED CHAIN SAW

- 32cc engine handles tough jobs
- Hard chrome cylinder bore for longer engine life
- Gear driven automatic chain oiler
- 3 position choke for easier starting
- Safety trigger prevents accidental acceleration • 15 lbs. ship. wt.
- Spark arrester screen reduces fire hazard
- Features: chain brake/hand guard, chain catcher, throttle latch, muffler shield, and low kickback chain
- 10-1/2 fl. oz. fuel tank capacity
- Factory reconditioned, factory perfect

ITEM 51502-15XA **\$79⁹⁹**

Pittsburgh

1/2 OFF

CORNER CHISEL



A slight hammer tap could give you perfect corners every time. Perfect for hinge plates.

- 5/8" working depth
- 3/8" cutting edge **\$4⁹⁹**

ITEM 07975-35XA

DEWALT

12" HEAVY DUTY COMPOUND MITER SAW



- 13 amps; 4000 RPM no load speed
- Spindle lock • Electric brake
- Stainless steel miter scale with 9 positive stops • 40 lbs. ship. wt.
- Includes 32 tooth blade
- 0-48° bevel capacity • 1" round arbor
- 0-48° miter left and right
- Capacities 5-1/4" crown moulding; 2 x 8 at 45° bevel; 4 x 4 & 2 x 6 at 45° miter
- Head lock down with handle for easy transport • 38 lbs. tool weight
- 100% ball bearing construction
- Factory reconditioned, factory perfect

ITEM 51594-45XA **\$299⁹⁹**

2 HP, 1200 PSI, 1.6 GPM PRESSURE WASHER



Starts when you pull the trigger, stops when you let go. Exclusive "Power-On-Demand" system dramatically increases the lifespan of your pump. Includes safety lock off trigger, fan to pinpoint spray nozzle, detergent cup, 19 ft. high pressure hose, and quick connection bayonet wand. Hooks to your garden water hose with no special adapters. For performance and value, this is an incredible deal. • Built in pressure relief safety valve • 120V, 13 amps

ITEM 50956-15XA **\$99⁹⁹**

PRESSURE WASHER TURBO NOZZLE

Increase your cleaning power by 20%! **\$9⁹⁹**
 ITEM 35935-05XA

CHICAGO Electric Power Tools



TRIANGLE DETAIL SANDER

Use 3-3/4" triangle pads to reach into corners conventional sanders can't.

- 110V, 1.2 amps
- 10,000 OPM
- Hook and loop sandpaper holder
- Includes dust collection bag
- 5 pc. sanding assortment 40, 80, 120, 200, and 240 grits

ITEM 35838-15XA **\$19⁹⁹**

5 PC. TRIANGLE SANDING PAD ASSORTMENT

• 40, 80, 120, 200, and 240 grits **\$3⁹⁹**
 ITEM 36082-05XA

DRILL MASTER

SAVE UP TO 40%



115 PC. TITANIUM NITRIDE COATED DRILL BIT SET

These titanium nitride coated high speed steel bits last up to six times longer than standard bits. Cool turning titanium bits are a must for metal workers. All bits can be resharpened. Straight shanks.

- Includes: 29 fractional sizes 1/16" thru 1/2"; 26 letter sizes A thru Z; 60 numbered sizes 1 thru 60; Heavy duty metal drill index

ITEM 01611-15XA **\$49⁹⁹**

115 PC. M-2 HIGH SPEED STEEL DRILL BIT SET W/INDEX

• Same sizes as above **\$29⁹⁹**
 ITEM 00528-15XA

* Within the 48 States / \$2.95 handling on all orders
 Call To Order or Ask for Free Catalog:
 Order 24 Hours a Day/7 Days a Week
 Most Phone Orders Shipped in 48 Hours



FAX TOLL FREE: 1-800-905-5220

1-800-423-2567

CHARGE IT!



Or Send Check or Money Order to: Harbor Freight Tools, 3491 Mission Oaks Blvd. Box 6010, Camarillo, CA 93011

FREE SHIPPING!

FOR ALL ITEMS SHOWN ON THESE TWO PAGES!

LOW PRICE GUARANTEE!

WE'LL BEAT ANY COMPETITOR'S PRICE ON ANY IDENTICAL ITEM - EVEN IF IT'S AN ADVERTISED SPECIAL



CHICAGO
Electric Power Tools

SAVE \$30 FROM OUR FALL '96 BOOK



8-1/4" COMPOUND MITER SAW

- Electric brake stops blade in seconds
- Powerful 1-3/4 HP motor, 120V, 9 amp, 4900 RPM no load speed
- 5/8" arbor
- Cutting capacity 2-1/8" x 5-1/8" miter, bevel, and compound cut
- Miter positive stops at 0°, 15°, 22.5°, 30°, and 45° left and right
- Bevel positive stops at 0° to 45° left
- 20 lbs. shipping weight
- Includes free 8-1/4" multi-purpose blade

ITEM 01078-2SXA

\$99⁹⁹

CENTRAL MACHINERY

1/3 HP



5 SPEED BENCH DRILL PRESS

- 620 to 3100 RPM
- 8-1/4" maximum distance spindle to table • 1/2" chuck
- 2" stroke, 8-1/4" swing
- 22-1/2" high, 49 lbs. shipping weight
- 1/3 HP motor

ITEM 05901-0SXA

\$48⁹⁹

DRILL PRESS WITH KEYLESS CHUCK

ITEM 34231-3SXA

~~\$69⁹⁹~~ **\$54⁹⁹**

CENTRAL MACHINERY

FREE ACCESSORIES:
Stand, 6" belt, 9" disc, open-end wrench, and hex key wrench



COMBINATION 6" BELT AND 9" DISC SANDER

1HP, 110V, 8 amps, 3450 RPM, all ball bearing motor; Overall height: 40"; Table tilt 0° to 50°; Table surface: 6-1/2" x 12-3/4"; Two position work table for disc or belt use; Disc speed: 1720 RPM; Belt: 6" W x 48" L; Belt speed: 1280 FPM; Weight: 121 lbs.

ITEM 06852-6SXA

\$169⁹⁵

DRILL MASTER



SAVE UP TO 25% FROM OUR FALL '96 BOOK

TiN COATED FORSTNER BIT SETS

Titanium nitride runs cooler, cuts easier, and lasts longer than standard steel! Includes 3/8" shanks and individually organized wooden case. Rockwell hardness range from 55-65 HRC.

20 PC. SET

- 20 sizes from 1/4" to 3/4" by 16ths, 7/8", 15/16", 1" to 2" by 8ths

ITEM 31130-7SXA

\$34⁹⁹

16 PC. SET

- 16 sizes from 1/4" to 2-1/8" by 8ths

ITEM 32404-8SXA

\$29⁹⁹

CHICAGO
Electric Power Tools

3-1/4" PLANER

- Front base has a V-groove to help guide in chamfering • 2 blade cutter
- Depth adjustment knob
- Includes rabbeting guide plate/fence, sharpening holder, blade setting jig, replacement brushes, replacement belt
- D-handle with lock-on button
- 1/10" maximum depth of cut; 3-1/4" planing width
- 110V, 5 amps, 17,000 RPM
- 34,000 cuts per minute
- Tool wt.: 6-1/4 lbs.

SAVE 24% FROM OUR FALL '96 BOOK

ITEM 32222-9SXA

\$39⁹⁵

2 PC. REPLACEMENT BLADES

ITEM 33262-2SXA

\$7⁹⁵

SAVE UP TO 33%

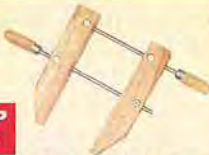

CONTROLLED PRESSURE, NON-MARRING HARDWOOD CLAMPS

These hand screws will clamp without scratching or marring your workpiece. Hardwood jaws distribute pressure evenly, and can easily be adjusted for non-parallel surfaces and odd shapes.

JAW LENGTH	JAW CAPACITY	ITEM	REGULAR PRICE	PRICE
8"	4-3/4"	04852-3SXA	\$5.99	\$3⁹⁹
10"	6"	04853-4SXA		\$4⁹⁹
12"	8-1/2"	04854-7SXA		\$5⁹⁹

CENTRAL PNEUMATIC
CONTRACTOR SERIES

18 GAUGE AIR BRAD NAILER

- This unit has the features you need: safety trigger, adjustable nailing depth, durable aluminum magazine, and easy jam clearance.
- 55-95 operating PSI • 1/4" NPT inlet
- 3/8" to 1-1/4" brad length capacity
- 100 brad maximum capacity
- 18 gauge brads • Tool wt.: 2-3/4 lbs.
- Stainless steel driver & cylinder

ITEM 31308-3SXA

~~\$49⁹⁹~~ **\$39⁹⁹**

18 GAUGE BRADS PACKS OF 5000 PRICE

SIZE	ITEM	PRICE
3/4"	33205-7SXA	\$2⁹⁹
1"	33206-3SXA	\$3⁹⁹

CENTRAL MACHINERY



DOVETAIL MACHINE

Just place stock and pull cam handles to positively lock material in place. Allows cutting tails, pins, half blind, and standard dovetails. Accepts stock up to 12" wide and 1-1/4" thick.

~~\$52⁹⁹~~ **\$39⁹⁹**

ITEM 34102-8SXA

DELTA
Delta 22-540

LIMITED QUANTITIES

12" PORTABLE PLANER

- Motor: 15 amp, 120V
- Capacities: 12" width, 6" thick, 3/16" depth of cut
- 26.2 FPM feed rate
- Table size with extensions: 12-1/8" x 26"
- 8000 RPM, 16,000 CPM
- Long lasting high speed steel, reversible, double edged knives
- Includes removable table extensions, and fold away depth adjustment for easy transport
- 27-1/4" x 20-1/2" x 15" overall dimensions
- 68 lbs. tool weight
- Factory reconditioned factory perfect

ITEM 06177-1SXA

\$299⁹⁹

PLANER BLADES

ITEM 33075-0SXA

\$19⁹⁹

CONVERTS A 4" GRINDER INTO A CUT-OFF SAW



CUT-OFF SAW CONVERSION KIT

- Turns your 4" grinder into a cut-off saw
- Plate dimensions: 9-1/2" x 9-1/2"
- Spring returns arm to ready position
- Uses grinders side handle mount
- Maximum vise opening: 4"

ITEM 31848-1SXA

\$9⁹⁹

CHICAGO HEAVY DUTY 4" DISC GRINDER

- 115V, 5.18 amps, 10,000 RPM
- 5/8"-11 spindle with 7/8" arbor adapter
- 11" long, 4-1/2" tool weight

ITEM 01711-4SXA

\$19⁹⁹

CENTRAL MACHINERY
DRILL 1/4", 3/8", AND 1/2" SQUARE HOLES

MORTISING MACHINE

Make a square hole in the fraction of the time it takes by hand! Fence with hold down clamp keep workpieces from lifting off the table. Large capacity - up to 5" maximum height. Includes fence, workpiece clamp, and 1/4", 3/8", and 1/2" mortising chisels and bits.

- 1/2 HP, 110V, 2.3 amps • 5" throat
- 5" maximum workpiece height
- Accepts .745" chisel shanks
- 3580 spindle speed • 13-3/8" x 6" table
- 10-7/8" x 7-3/4" base • 60 lbs. ship. wt.

ITEM 35570-1SXA

~~\$199⁹⁹~~ **\$169⁹⁹**



2 PC. SUPER STUBBY SCREWDRIVER SETS

These super short stubbys get into areas so small stubbys can't even fit! Perfect for appliances, stereos, television, and more. Features an easy grip handle and chrome vanadium bit. 1-5/16" overall length.

REGULAR PRICE: \$1.99

A. 3/16" AND 1/4" STANDARD

ITEM 35438-1SXA

99¢

B. #1 AND #2 PHILLIPS

ITEM 35437-1SXA

99¢

* Within the 48 States / \$2.95 handling on all orders
Call To Order or Ask for Free Catalog:
Order 24 Hours a Day/7 Days a Week
Most Phone Orders Shipped in 48 Hours



FAX TOLL FREE: 1-800-905-5220

1-800-423-2567

CHARGE IT!



Or Send Check or Money Order to: Harbor Freight Tools, 3491 Mission Oaks Blvd. Box 6010, Camarillo, CA 90101

Dovetail-jig stabilizer fence

It offers firm support and aids alignment

Have you ever struggled to keep boards properly aligned in your dovetail jig? Most jigs rely on a small cam to position the board; but don't provide enough support along the length of the board to prevent racking. Without proper alignment, the dovetails vary slightly in length, resulting in a poor fit.

Our dovetail jig fence provides support on both horizontal and vertical planes. And, the fence bars adjust so you can fine-tune them to match your jig setup. We built this fence for a Porter-Cable

model 5008 Dovetail Templet, but you can adapt the fence to fit your particular jig.

To make the fence, cut the body pieces (A, B, C, D, and E) to size. Using your tablesaw, rip a $\frac{1}{8}$ " groove $\frac{1}{4}$ " deep in the top plate (A) where shown on the Exploded View drawing. Reset the blade depth to $\frac{1}{2}$ ", then cut the rabbet in the front plate (B) where shown.

Fasten the top and front plates (A and B) to the clamping and support blocks (C and D) with glue and screws as shown. Then

position the dovetail jig in the groove and mount it with screws.

Drill $\frac{1}{4}$ " counterbored holes where shown in the front plate (B) and fence plate (E), and insert $\frac{1}{4} \times 2$ " carriage bolts in the holes. Clamp the fence plate (E) in position, making sure the top of the plate is flush with the face of the jig. Then, attach the fence plate with screws as shown.

Cut the fence bars (F and G) to size and cut a $\frac{1}{8} \times \frac{1}{8}$ " rabbet on one edge. Using a $\frac{3}{16}$ " bit, drill holes as shown in the Slot Detail drawing to create the $\frac{5}{16}$ " slots. Install the fence bars with washers and wing nuts as shown.

To adjust the fence, set the jig for a particular type of dovetail joint, then clamp a scrap board vertically in the jig. Insert a board horizontally in the jig and align its squarely cut end firmly against the vertical scrap. Then, position the top fence bar against the edge of the horizontal board and tighten the wing nuts down.

To make vertical adjustments, clamp a board horizontally in the jig, and index the squared end of a vertical board against it. Then, slide the front fence bar against the edge of the vertical piece and tighten the wing nuts.

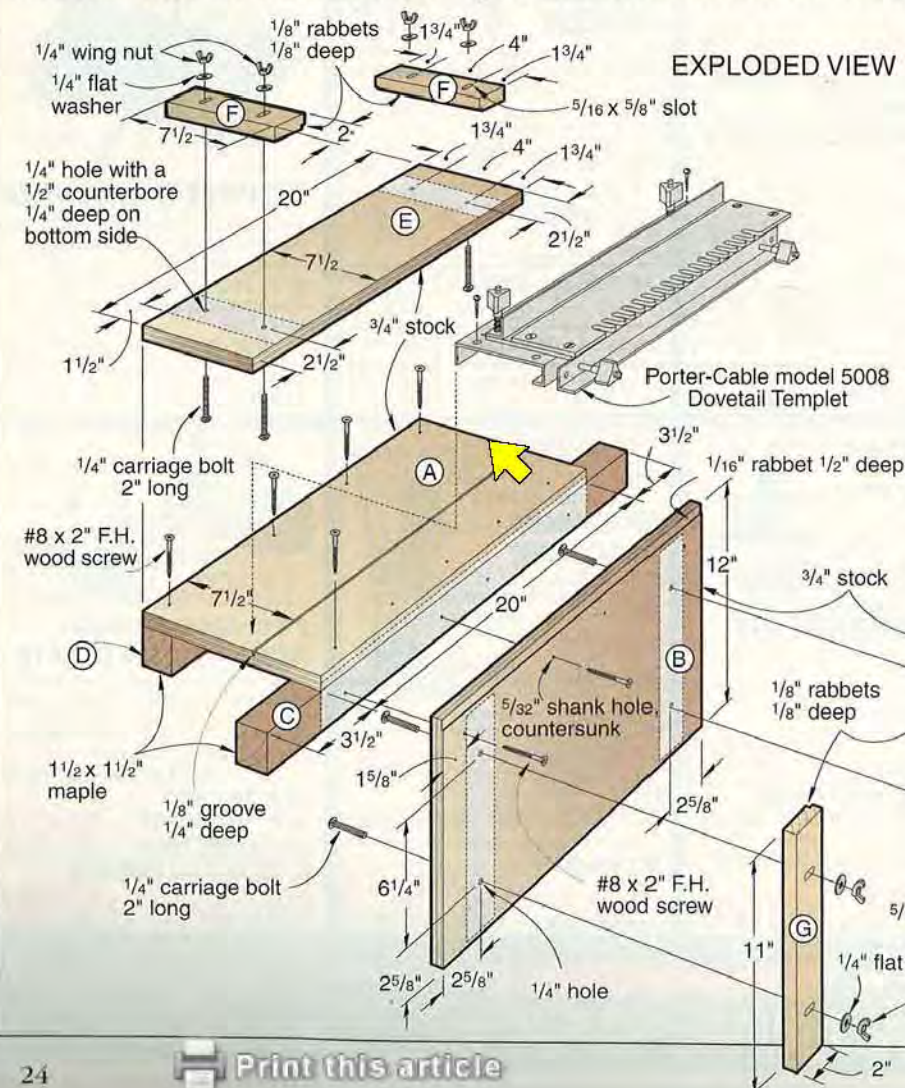
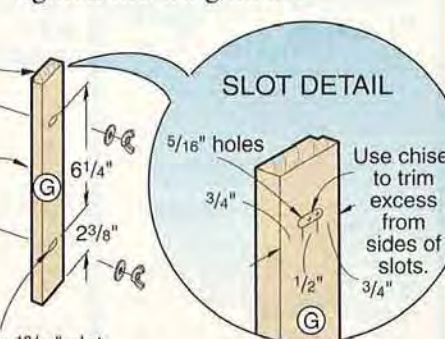

Project Design: Chuck Hedlund
 Illustrations: Roxanne LeMoine
 Photograph: John Hetherington



The Furniture Repair Business Can Put You On The Road To Independence.



Become the owner of a homebased, mobile franchise. Go right to where the business is; you don't have to wait for the business to come to you.

You can offer your customers furniture and upholstery repair, fabric cleaning and protection, refurbishment of kitchen cabinets, and reconditioning of wood decks.

You'll be backed by the largest supplier of furniture finishes in the U.S. and be partnering with an industry leader with strong name recognition.

"Guardsman makes the finishes, so who would a customer rather have repair their furniture? Guardsman also cared more about building market share than selling franchises."

Brian Fabre—Missouri

To learn more, please call:

1-800-4-WoodPro (800) 496-6377

In Canada (888) 966-3232

Investment range \$12,000 - \$20,000. Offer made by Prospectus only. Unit & Master Franchises available worldwide.

GUARDSMAN
**WOOD
PRO**

Saw Thick - Sand Thin

It's the best kept secret!

Scrollsaw thicker stock and then sand to your desired thinness. Even the most delicate fretwork, as thin as 1/64", can be sanded without breakage.

Imagine the satisfaction of sanding a wide surface (up to 32") to within .010" uniform thickness across its full width. Or sanding stock as short as 2 1/4" without a carrier board or scuffed up fingers.

We saved the best for last. There is an easy way to remove pattern paper. Simply sand it off!

16-32 Plus



Proudly Made in the USA

Make your
woodworking the
pleasure it was
meant to be.
Call us today for a
free brochure and
the dealer nearest
you.

**PERFORMAX
PRODUCTS, INC. X**

Drum and Brush Sanders Designed for
Maximum Performance, Maximum Value

12257 Nicollet Ave. So.
Burnsville, MN 55337

(612) 895-9922 1-800-334-4910

NEW - READY-TO-WRAP ABRASIVES

Circle No. 78

TOOLS OF THE TRADE

Any woodworker knows that using the right tools for a project makes all the difference. That's why the Titebond® Family of Wood Glues has been the choice of professionals for more than 35 years. Recognized as the premier name in wood glues, Titebond has five specially-formulated glues for your next woodworking project.

Titebond II Premium Wood Glue—Weatherproof

◆ Ideal for outdoor projects—passes Type II water-resistance

Titebond Original Wood Glue—Stronger than wood

◆ Strong initial tack—heat resistant and sands easily

Titebond Dark Wood Glue—For darker woods

◆ Offers all the benefits of Original Titebond

Titebond Liquid Hide Glue—Slow set

◆ Use to create "crackling" or antiquing effect

Titebond Wood Molding Glue—No runs, no drips

◆ Thicker formula—sets fast, yet allows realignment of pieces

To find out which glue will work best for your next project or to find out where you can purchase Titebond in your area, call our Technical Service Team at 1-800-347-GLUE.

The professional's choice
Titebond®



Save 55% on MLCS Raised Panel Door Bit Sets

Carbide Tipped!

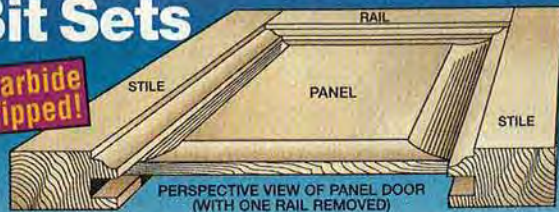

Make Beautiful Raised Panel Doors with your 1/4" or 1/2" Router, or with your 1/2" or 3/4" Shaper.

Our professional production quality router bits make it quick and easy to produce attractive raised panel doors. Our reversible combination bit makes a matching rail and stile frame. The panel raising bit with ball bearing guide makes a perfect raised panel every time!

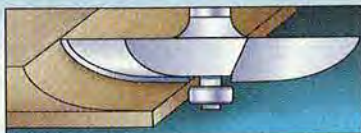

*Raised Panel Router Bit



*Reversible Combination Rail & Stile Bit Works with stock from 11/16" to 7/8".

Includes instructions & professional tips!

Carbide Tipped RAISED PANEL DOOR SETS

SET#	BIT STYLE	RAISED PANEL LRG. DIA.	SET PRICE
#1301	1/4" Shank Router	* 2"	\$69.95
#1302	1/2" Shank Router	* 3-1/2"	\$79.95
#1303	1/2" & 3/4" Shaper	4-5/8"	\$99.95

*Ball bearing included

QUANTITY DISCOUNT
When ordering 3 or more router bits deduct \$1.00 each!

1/4" SHANK CARBIDE TIPPED ROUTER BITS

Professional Production Quality Guaranteed!

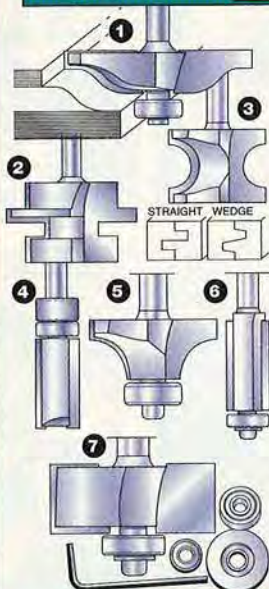

- OGEE RAISED PANEL**
#1423 2" Large Diameter\$29.95
- TONGUE AND GROOVE**
#1333 Straight\$29.00
#1335 Wedge\$29.00
- BULL NOSE**
#1330 1/2" Dia. of Circle\$16.00
#1331 3/4" Dia. of Circle\$21.00
- PATTERN/FLUSH TRIM**
#1340 1/2" Dia., 1" Cutting length\$15.00
#1341 3/4" Dia., 1" Cutting length\$17.00
- ROUND OVER**
#1314 (1/8" Radius)\$11.00
#1315 (3/16" Radius)\$11.00
#1394 (1/4" Radius)\$13.00
#1316 (5/16" Radius)\$14.00
#1369 (3/8" Radius)\$15.00
#1370 (1/2" Radius)\$17.00
- FLUSH TRIM**
#1337 3/8" Dia., 1" Cutting length.\$8.50
#1338 1/2" Dia., 1" Cutting length.....\$9.50
- RABBETING KIT**
Change ball bearing guides and select 4 depth of cuts: 3/8", 7/16", 5/16", 1/4". Set: 1/4" shank rabbeting bit, 4 bearings (3/8", 1/2", 5/8", 3/4") and hex key.
#1425 1-1/2" Large Diameter\$25.00

MLCS Woodworking Accessories **ON SALE!**



25pc Brad Point Drill Bit Set

Drill accurate holes in wood, plastics & composites.

Bit sizes from 1/8" to 1/2" by 1/64" increments. Bits are deep fluted to clear chips quickly.

ITEM #1413
REG. \$34.95 **SALE \$18.95**

METAL CASE & BIT HOLDER INCLUDED!



Biscuit Joining Set

5/32" Slot Cutter-1/4" Shank and 250 #20 Biscuits

"Biscuit Joining with your Router", Instructional sheet included.

ITEM #1385
REG. \$35.00 **SALE \$29.95**

FAST & EASY



MERLE The ADJUSTABLE CORNER CLAMP®

- Adjustable, uniform clamping pressure on all corners
- Great for wide cabinet frames (for center or edges)
- Forces a frame into perfect square
- Almost NO capacity limitation, ships with 23 FEET steel banding
- Aluminum & Steel construction

ITEM #1420
REG. \$39.95 **SALE \$24.95**



Router Speed Control

Gets the best results with the wood and bit you are using!

- Works with all routers 3-1/4" HP or LESS - 120V 15 Amp
- Full horsepower and torque at all speeds
- Gives your router a feature only available on routers costing hundreds of dollars!

ITEM #1304
REG. \$49.95 **SALE \$34.95**

Includes Dust Cover



NEW! Brass Piloted Router Bits

Carbide Tipped!

New bit saves hours of hand sanding!

Rout into those tight spaces and sharp corners! These professional grade router bits have smooth running Brass Pilots, measuring only 5/32" (approx.) in diameter, instead of the usual 1/2" ball bearing. Save hours of hand sanding or filing and get a more consistent edge.

Unique Brass Pilot:
Approximately 5/32" in diameter! It's 11/32" smaller than typical ball bearing.

Order 3 or more bits & deduct \$1.00 each!

Set #	Description	Shank Size	Price
#1428	1/8" R Round Over	1/4"	\$16.00
#1429	1/4" R Round Over	1/4"	\$17.00
#1430	3/8" R Round Over	1/4"	\$19.00
#1431	5/32" R Roman Ogee	1/4"	\$20.00

Expert Technical Help Before & After Sale

FREE 40 PAGE CATALOG!



FREE SHIPPING*
*IN CONTIGUOUS USA FOR ALL ITEMS

MLCS

Professional Woodworking Products

ORDER TOLL FREE
1-800-533-9298
24 HOURS A DAY

Order by Fax (215) 938-5070



Order By Credit Card or Send Check To:
MLCS, Ltd.,
P.O. Box 4053D N
Rydal, PA 19046

His sticks are made for **WALKIN'!**

Kentuckian Tom Smith supports his fishing with a unique brand of woodworking, and he couldn't be happier.



Daniel Boone wasn't much for spelling, and Tom Smith thanks him for that. "In one of his early letters from what was then the frontier, ol' Daniel spelled Kentucky 'Kantucke.' I just continued his style," explains Tom Smith about how he came to name the "Kantucke Wolken Stiks" he makes and sells. "If one misspelled word could catch someone's attention, why not misspell them all?"

"People throughout history liked to carry walking sticks. Even Moses had one," says Kentucky stickmaker Tom Smith, resting on a wall near his farm.

Continued



"My best-selling stick is the spiral in walnut, the diamond is next, then the plain," notes the stickmaker. The 52" stick *left of center*, with its brass tip, retails for about \$200. Tom also does custom sticks, such as the wading staff for fishing, at *left*.



The twisted sassafras for the tall hiking stick comes from Tennessee. Tom taps his supply of old tobacco-drying sticks to offer the simple, rectangular model. The design *far right* he calls the Tootsie Roll.

That christening four years ago has resulted in a retirement enterprise that has grown beyond the 65-year-old's greatest imagination. A member of the Guild of Kentucky Craftsmen, Tom now tallies nearly three dozen retail outlets for his sticks across the nation. Those accounts, plus the five or so craft fairs he does each year, keep his stick production at around 450 annually. That leaves plenty of time for fishing.

"All I wanted to do in retirement was keep active—find something to do to help support my fishing," Tom laughingly admits. "But golly, in my wildest dreams I never thought I could make anything that someone would pay so much money for," he says in wonderment. In his hands he displays a satin-finished walnut walking stick, its shaft decorated in a carved diamond pattern. Topped with a

bright brass hame knob from a horse collar and adorned with a woven leather lanyard, the 52" stick has a price tag of \$200.

Moses carried one, too

A few years before he retired from his job as a steel inspector with the Kentucky department of highways, Tom was giving serious thought to how he would spend his future days. "Then one day Sissy [his wife Elizabeth] and I were visiting a craft fair and saw this old gentleman," he recalls. "There he was, walkin' down the street in bib overalls and gum boots like you wear around the cattle barn. He was carrying this long stick with a bandanna wrapped around the holdin' end. Well, that sight started me thinking about walking sticks. Seems that people have always wanted something to aid their walking, kind of

like a companion. Why, even Moses carried a stick."

Back on their 63-acre farm outside of Frankfort, Tom began some experiments in stickmaking. "I went directly from working with steel to wood," he says. "I never had much to do with wood, but my dad once operated a sawmill right when I was born, so maybe there was sawdust in my blood and it finally came out."

The sawdust took a while to emerge, as Tom tells it. "I got to playing with the idea of making sticks and made two or three prototype models. Just whittled on 'em with a knife. Finally, Sissy said, 'Why don't you make some kind of design on them?' So I carved some spirals and some diamonds. But it was really tough."

Tom, a problem solver, figured there had to be a better way. And there was, right at his fingertips.

“Seems that people have always wanted something to aid their walking, kind of like a companion.”

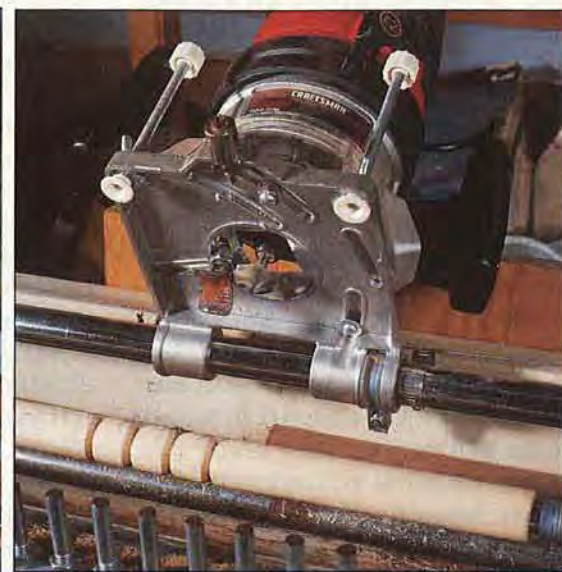

Notice the metal “saddle” to the left of the bit. It was added to prevent bowed wood from getting a deeper bite from the router.

The Craftsman Router Crafter gives Tom a design versatility and the speed to keep up with orders. He routs spirals with a 1½-hp router and an ogee bit.

Router to the rescue

“I got to lookin’ through the Sears Roebuck catalog and saw this Router Crafter,” Tom remembers. “It was like a lathe, with a router riding on top. Fitted with a bit, I could index it to cut designs on the sticks as they turned. But I needed a lathe, too. Eventually, I ordered a Router Crafter and a lathe, then wasted a lot of wood until I got the technique, and the right wood, down pat. You see, I was using green wood at first—I’d just go back on the property and cut down a wild cherry tree or a yellow poplar, split it out, then put the splits on the lathe to round them down to the diameter I wanted. With the Router Crafter, I’d add the designs.

“But the green wood fuzzed up,” he continues. “Then, the sticks cracked as they dried. But I was starting to sell them anyway, and

knew I had to do something to get better speed and quality. Finally, I bought kiln-dried wood.”

Tom now uses nothing but. And he buys the hickory and walnut stock already round in the form of 1"- and 1½"-diameter dowels cut to 36" and 48" lengths.

Horsing around for the perfect stick

Tom was busy perfecting his turning and cutting techniques while still making sales at craft fairs. He was purchasing preturned finials and attaching them to the top of his walking sticks. He also had found a source for a different style of stick.

“I met a guy from Tennessee who had a supply of sassafras sticks,” Tom explains. “Where he lives, young sassafras saplings get entwined with wild grape vines. The result is a naturally twisted

stick. I clean them up and leave some bark on, varnish them, and add a leather thong. They look more like a hiking stick, and the outdoor types buy them.”

Yet it was horses more than anything else that ended up offering Tom the most unusual adornment that now makes his sticks stand out. “Sissy and I took a day to tour Shaker Village of Pleasant Hill. There, they have a beautiful team of draft horses that pull a wagon around the village,” he says. “They really looked good, with oiled harnesses and polished brass fittings. Well, I got to looking at the brass hame knobs that guide the reins. Why couldn’t I put those knobs on my sticks?”

Why not, indeed. But Tom had to find them first.

Some turned up at flea markets. More were found at farm sales, especially in Amish areas. Garage

Continued

“A while back, I was thinking that maybe I was

sales turned up a few. To this day, the search goes on for horse collars with the valued hame knobs. “Friends and neighbors keep on the lookout for them,” says Tom, “but as yet I haven’t found a reliable supplier for new hame knobs.”

So far, Tom and Elizabeth have discovered five different shapes of knobs. “I started out by putting little round ones on my sticks, but everyone called them doorknobs,” notes Tom. “Now, I try to use only the longer type, which weigh three to four pounds.”

It’s a logical thought: With a heavy brass head and downright tough wood like hickory, Tom’s sticks might play a role other than that of a walking companion. The craftsman downplays the idea of his sticks as a means of self-defense, though. “That’s not part of my sales pitch,” he says. “Although I did have a fella come by at a show and ask for a plain hickory stick—no carving—with a heavy hame knob. Turns out there was a bad neighborhood between

his house and his favorite tavern, and he wanted something strong to carry walking through it.”

Tom fulfills more personalized requests, too. Such as a special type of wood, or a brass plate engraved with names and dates. He even provided a shovel fitted with a hame knob to the governor of Kentucky for an official groundbreaking. Usually, however, the requests are minor, and he handles them on the spot.

“One time we had a short man from California come up to our booth. He wanted a walking stick, but a littler one. I told him I could cut a 36” one down, and proceeded to saw off an inch, then another inch, and he kept nodding to keep going. Finally, it was down to about two feet long before he said that would do. ‘You had better buy it now,’ I said, ‘because no one else will.’ And he did.”

And when a new opportunity arises, Tom doesn’t hesitate to add to his lineup of sticks. “A while back, I was thinking that maybe I

was missing a whole end of the market—the low end,” he says, reaching to snare yet another stick from his stock. “These are tobacco sticks, used to hang tobacco leaves up in the barn to dry. In this part of the country they’re mainly white oak. I cut them off to 45”, sand the heck out of them and varnish them, and brand on ‘Kentucky Tobacco Stick.’ Then, I wholesale them with a leather thong for seven bucks apiece. My other sticks start at \$35 wholesale. And I’ve got about 5,000 tobacco sticks out in the barn left from the time when I raised tobacco.”

Round and round, he makes his mark

Key to getting an impeccably cut design on a walking stick is centering and indexing, advises the stickmaker about his main tool, the Router Crafter. “Of course, I start with a round stick blank that’s usually 36×1”. To find the exact center of each end for mounting, I use a center finder,



missing a whole end of the market—the low end.”

then make a hole at each point with an ice pick.”

Tom mounts the stick to be routed onto the machine, lining it up with the index points for the number of cuts per inch of stick circumference he's selected.

Next, Tom turns the crank on the Router Crafter to check the straightness of the wood. “If the stick has a little bow in it, I'll go to a less demanding design, such as fewer spirals,” he says. “For the spirals, you see, I can cut four to six for every inch. No closer than six, though. To get the diamonds, I set the index, say to four, then go down the stick. When finished, I reverse the stick end to end and go down it again. I do it all with a Vermont American ogee bit chucked in my 1½-hp router.”

To counter any bow in the stick, Tom devised a half-round metal saddle mounted on the router base ahead of the bit (see close-up, page 29). “It acts like a bumper to keep the bit the same distance from the turning stick so that it won't tear out if the wood has a bow in it,” he notes.

For 4' sticks, Tom uses his second Router Crafter. He extended its original 36" rails to

48". “I also added a support under the rails because the longer sticks want to whip,” he notes. “The compression of the stick between the drive center and the tailstock also exaggerates any bow. Without that support, I couldn't use 40 percent of the wood I buy!”

After routing the design in a stick, Tom removes it from the machine and clamps it in his shaving horse. There, he hand-sands the cuts smooth with a teardrop-shaped sander made of foam rubber covered with 120-grit paper. The handwork takes about 20 minutes, except for hickory sticks.

“Hickory is so hard that I have to make two or three passes on the Router Crafter to just one for walnut. It often burns in the routing, too, so I have to take a flexible-shaft carving tool with a sanding wheel and clean it out,” says Tom.

While Tom has the stick clamped in the shaving horse, he takes the opportunity to shave one end of the shaft with a drawknife to accommodate the hame knob. For final sanding, Tom mounts the cleaned-up and shaved stick in his lathe and sands it with 80-grit.

For a finish, he coats the stick

once with polyurethane varnish and lets it dry. A light sanding with 60-grit cuts the raised grain. “The last coat of polyurethane, followed by a sanding with 120-grit, gives me a durable finish that looks just like I want it to,” says Tom. “I don't want my sticks real slick and shiny, but I like the yellowish cast of the varnish. It brings out the color of the wood.”

For the finishing touch, Tom fits the stick with a shiny hame knob of solid brass and predrills the screwholes with a hand brace. A few twists with a screwdriver and another Kantucke wolken stik is ready for market. Tom admires his work, then says: “I've gotten so now that I have a piece of power equipment for every major step that I need to do on my walking sticks. But it always makes me feel good to end it up with a good old hand tool.” ♣

For a bit of Olde Kantucke

To receive a catalog sheet describing Tom's line of walking sticks, send your request with a SASE to Olde Kantucke Wolken Stiks, Inc., 1280 Old U.S. 60, Frankfort, KY 40601.



Far left: Tom built the solid cherry shaving horse to grasp sticks for detail sanding. Here he shaves the end of a stick with a drawknife in order to add the hame knob. Note the harnesses hanging about.

Middle: Today, the lathe gets little use for turning. Tom mounts sticks there for sanding. “But I did waste and use up an awful lot of wood at it,” says the craftsman.

Near left: Tom predrills screwholes with a hand brace to attach the brass hame knob, just part of the handwork that goes into his line of walking sticks.

Written by Peter J. Stephano Photographs: John F. Schultz

One cool Catchall

A beautiful box that's a breeze to build



Desktops and dressers act like clutter magnets—stuff always seems to be drawn to them. This clever little box can help contain it all. And building this bandsawn beauty is so simple, you'll want to make several for family and friends.

Bandsaw the lid and bottom

1 Cut two pieces of stock $1\frac{1}{16} \times 4 \times 5\frac{3}{4}$ " for the lid (A) and bottom (B). (We used walnut.) Stack them, then look at the edges. The grain should run in the same direction, giving roughly the appearance of one thick piece of stock. If not, turn one piece around or flip it over to achieve the most seamless look. Mark the mating faces for orientation.

2 Chuck a $\frac{3}{8}$ " round-over bit in your table-mounted router. Rout the upper edges of the lid and the lower edges of the bottom where shown by the Lid and Bottom Side View drawing.

3 Transfer the inside cutting lines from that drawing to the lid (A) and bottom (B). You can photocopy the drawing, cut it into the two parts, and adhere them to the stock. Or, you can lay out the cutting lines directly on the stock, measuring from the drawing.

4 Adjust your bandsaw for a 6" cutting depth. Then, standing the lid (A) on its unpatterned end, saw along the inside line. Then, saw the bottom, as shown *right*.

5 Sand the lid and bottom inside and out with 100-, 150-, and 220-grit sandpaper. Wrap your sandpaper around a length of dowel rod to sand the inside corners, as shown *opposite page*. Using a disc sander, sand about $\frac{1}{16}$ " from one end of the lid, making it shorter than the body. This will allow the lid to open freely after assembly.

The ends come next

1 With double-faced tape, laminate two $\frac{1}{2} \times 3 \times 5$ " pieces of stock, good faces together, for the ends. Choose a wood that contrasts with the body. (We used maple.)

2 Photocopy the Ends pattern. Adhere the copy to the laminated stock with rubber cement or spray adhesive.



Stand the lid and bottom on end to saw the inside contours.

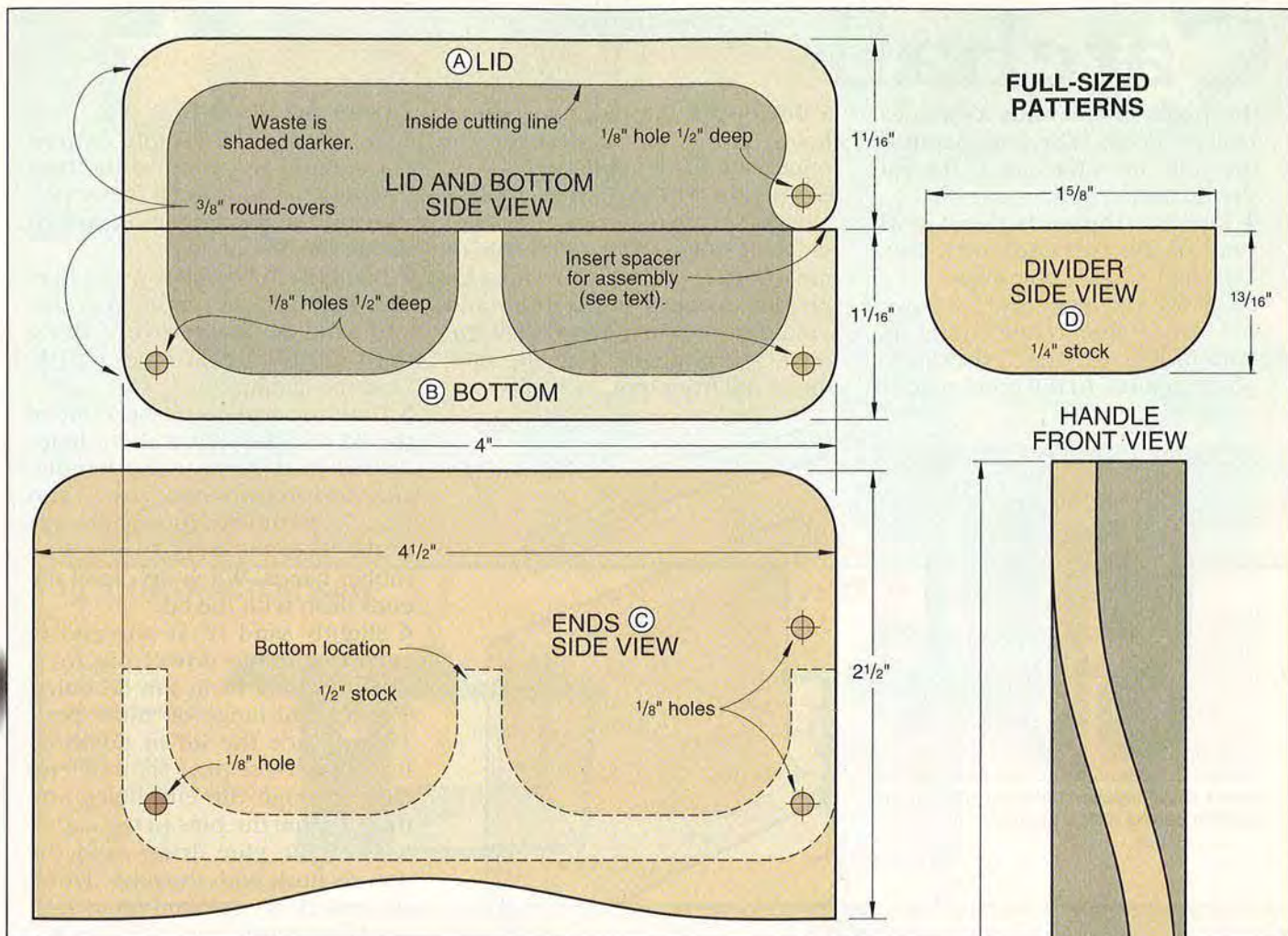

3. Drill the three $\frac{1}{8}$ " holes through both ends where shown. For accuracy, employ a drill press. Back the workpiece with scrap-wood to prevent tearout.

4 Bandsaw around the outer pattern line. For a smooth edge, saw slightly outside the pattern line,



Sand the inside curves with sandpaper wrapped around a dowel.

then sand down to it. Remove the paper pattern, and separate the two pieces. Remove traces of adhesive with lacquer thinner.

5 Rout a $\frac{3}{8}$ " round-over along the front, back, and top edges of the outer face on each endpiece. Rout the parts facedown on a router table, making multiple shallow cuts.

Glue on the ends

1 Sandwich a spacer about $\frac{1}{16}$ " thick between the top and bottom. (We used the cardboard back from a memo pad.) Bind the pieces together with masking tape as shown *next page*, keeping the ends and edges flush.

2 Clamp the ends to the bottom/lid assembly. Position the ends flush with the top of the lid and the back (hinge side).

3 With a drill press, drill two $\frac{1}{8}$ " holes in each end of the body and one in each end of the lid, using

Continued

Catchall

the holes in the ends as guides. Drill $\frac{1}{2}$ " deep. (The total depth of the holes from the face of the end should be 1".)

4 Remove the ends. Sand both sides of the two ends with 100-, 150-, and 220-grit abrasives.

5 Cut six $1\frac{1}{8}$ " lengths of $\frac{1}{8}$ " dowel rod. Apply glue to one end of the bottom (B), and attach the appropriate end (C) to the bottom. Push

a dowel pin into the two lower holes on the end. Repeat for the other end. Clamp until dry.

6 Adhere a photocopy of the Divider pattern (D) to a $\frac{1}{4}\times 1\times 2$ " piece of stock. (We used maple to match the ends.) Cut out the divider, place it in position, and sand it to fit. Then, finish-sand the divider, and glue it into the middle of the front tray.

Dress up the lid

1 Photocopy the Handle pattern (E). Adhere the copy to the best face of a piece of stock $\frac{3}{8}\times\frac{3}{4}\times 5\frac{3}{4}$ ". (We cut the handle from maple to match the box ends.)

2 Bandsaw or scrollsaw the handle. Remove the paper pattern, and sand $\frac{1}{8}$ " round-overs along both edges of that face. Finish-sand the handle.

3 Glue the handle to the front of the lid (A), the side without holes drilled in it. Center the handle, and position it so the lower surface fits flush with the lower edge of the lid at the ends. Clamp with rubber bands. When dry, sand the ends flush with the lid.

4 Slightly sand $\frac{1}{2}$ " at one end of each remaining dowel pin for a snug, rotating fit in the lid holes. The lid will hinge on these pins. Then, place the lid in position. Push a dowel pin, sanded end first, through the end holes into the lid. Glue the pins to the ends.

5 After the glue dries, sand the dowels flush with the ends. Finish as desired. We sprayed on a clear, semigloss finish inside and out. ♣



Insert a $\frac{1}{16}$ " spacer between the lid and bottom before fitting the ends.

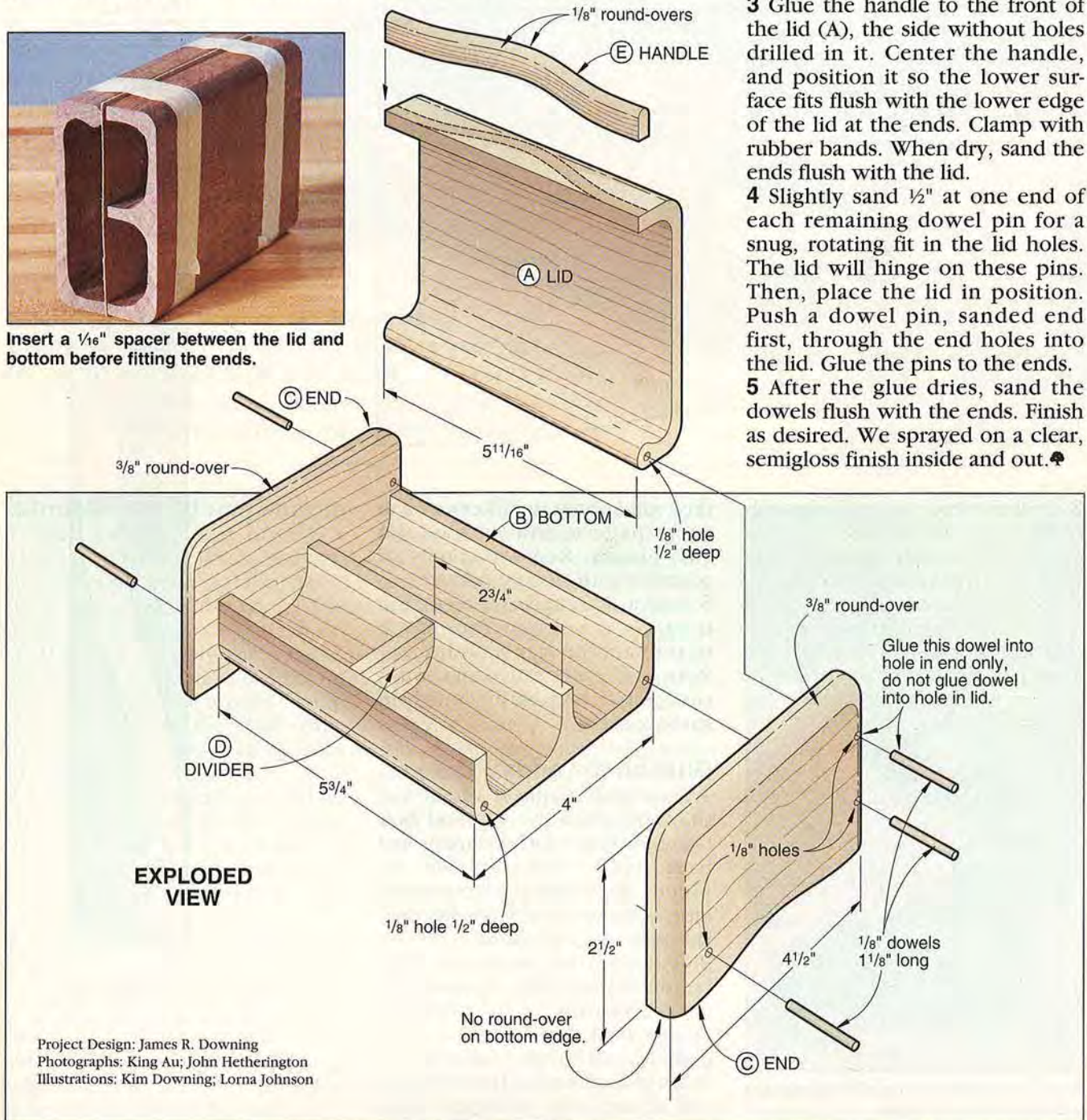

EXPLODED VIEW

Project Design: James R. Downing
Photographs: King Au; John Hetherington
Illustrations: Kim Downing; Lorna Johnson



STAR TOOLS, LLC.
TOLL FREE

1-888-678-8777

MON, - FRI, 7:00AM - 5:00PM (Pacific Time)



STAR TOOLS INTRODUCES TWO NEW MODELS FOR 1997

S3408 18" DUAL DRUM SANDER
3 H.P., (2) SPEEDS, REVERSIBLE
INTRODUCTORY PRICE ← \$925.00

S3206 12" CABINET SAW
5 H.P. SINGLE PHASE MOTOR
36" RIP CAPACITY, 4" DUST PORT
INTRODUCTORY PRICE ← \$1,750.00

1-1/2 H.P. SHAPER

- 1/2" & 3/4" SPINDLES
 - 2 SPEEDS / REVERSIBLE
 - **FREE** DUST HOOD S3302
- \$455.00**



3 H.P. SHAPER

- 1/2" & 3/4" & 1" SPINDLES
 - 2 SPEEDS / REVERSIBLE
 - **FREE** DUST HOOD S3303
- \$795.00**



OSCILLATING SPINDLE SANDER

- 1 H.P. 110 /220 VOLT
 - 1725 RPM
 - 24" X 24" TABLE TILTS 45°
- S3407
\$485.00



COMBINATION SANDER

- 6" BELT W/12" DISC
 - QUICK RELEASE ON BELT
 - 4" DUST PORT
- S3702
\$375.00

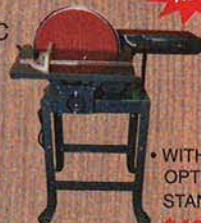

NEW

• WITH OPTIONAL STAND
\$400.00

10" CONTRACTOR SAW

- 2 H.P. 110/220 VOLT
 - 36" RIP CAPACITY
 - BUILT IN DUST CHUTE
 - **FREE** MICRO ADJUSTER S3226
- S3205
\$499.00
- TABLE BOARD NOT INCLUDED

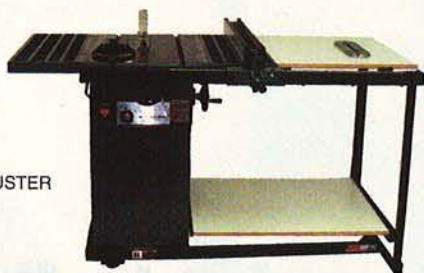

HEAVY DUTY CABINET SAW

CALL FOR NEW STAR TOOLS CATALOG



- S3202
SPECIAL PRICE \$995.00
- INCLUDES **FREE**:
- S3221 MOTOR COVER
 - S3226 MICRO ADJUSTER
 - S3857 DUST HOOD & FREE FREUD LU82 10" BLADE
- \$850.00**
- (SAW AND FENCE ONLY)

14-1/2 BANDSAW

- 3/4" H.P. 110/220 VOLTS
 - 6" RESAW CAPACITY
 - 1/8"-1" BLADE
- S3501
\$325.00



20" BANDSAW

- 3 H.P. 220 VOLT
 - 12" RESAW CAPACITY
 - ROLLER GUIDES
- S3506
\$1,295.00



EDGE SANDER

- 1-1/2 H.P. 110 /220 VOLT
 - 6" X 30" BELT SIZE
 - SANDS VERTICALLY & HORIZONTALLY
- S3406
\$465.00



25" DUAL DRUM SANDER

- 5 H.P. 220 VOLT
 - 2 SPEEDS 11 & 17 FPM /REVERSIBLE
 - CAST IRON WORK TABLE
- S3409
\$1,275.00



2 H.P. DUST COLLECTOR

- 1182 CFM
 - 2 INTAKES @ 4" or 1 @ 5"
 - STEEL IMPELLER
- S3820
\$270.00



12 1/2" PORTABLE PLANER

- 2 H.P. REVERSIBLE HSS BLADES
 - **FREE** 4" DUST HOOD
- S3712
\$385.00



8" JOINTER

- 2 H.P. /220 VOLT
 - 3 KNIFE CUTTERHEAD
 - 8" X 65" BED LENGTH
- S3107
\$725.00



6" JOINTER

- 1 H.P. 110 /220 VOLT
 - 3 KNIFE CUTTERHEAD
 - 47" BED LENGTH
- S3104
\$399.00



(JOINTERS SHOWN WITH OPTIONAL MOBILE BASE)

MAIN OFFICE SHOW ROOM
9825 PIONEER BLVD.
SANTA FE SPRINGS, CA. 90670
TEL; 310-654-3065
FAX; 310-654-3066

WEST COAST



EAST COAST



SHIPPING WAREHOUSE SHOWROOM
12 ARMORY ROAD,
CLARKSBURG, WV. 26301
(TECH SUPPORT ONLY) TEL; 304-624-6685
FAX; 304-624-8928

HELP WANTED: Strong, hardworking, dependable worker to assist in numerous large projects, including, but not limited to sawing, planing, sanding, ripping, routing and cutting. Must be able to press up to 350 lbs. Days, evenings, nights, weekends and holidays. No wimps, please.

CARPENTER NEEDED

Good help just got easier to find.

With the HorsePower™ Handy Clamp, you can get the help you need anytime, anywhere. It attaches easily to a saw horse, workbench or work vehicle. It turns your work surface into a clamping center so you can work safely and efficiently by yourself. And it never needs a coffee break. Find them wherever quality tools are sold.



Turns your work surface into a clamping center.

CHUBBY CHOO-CHOO

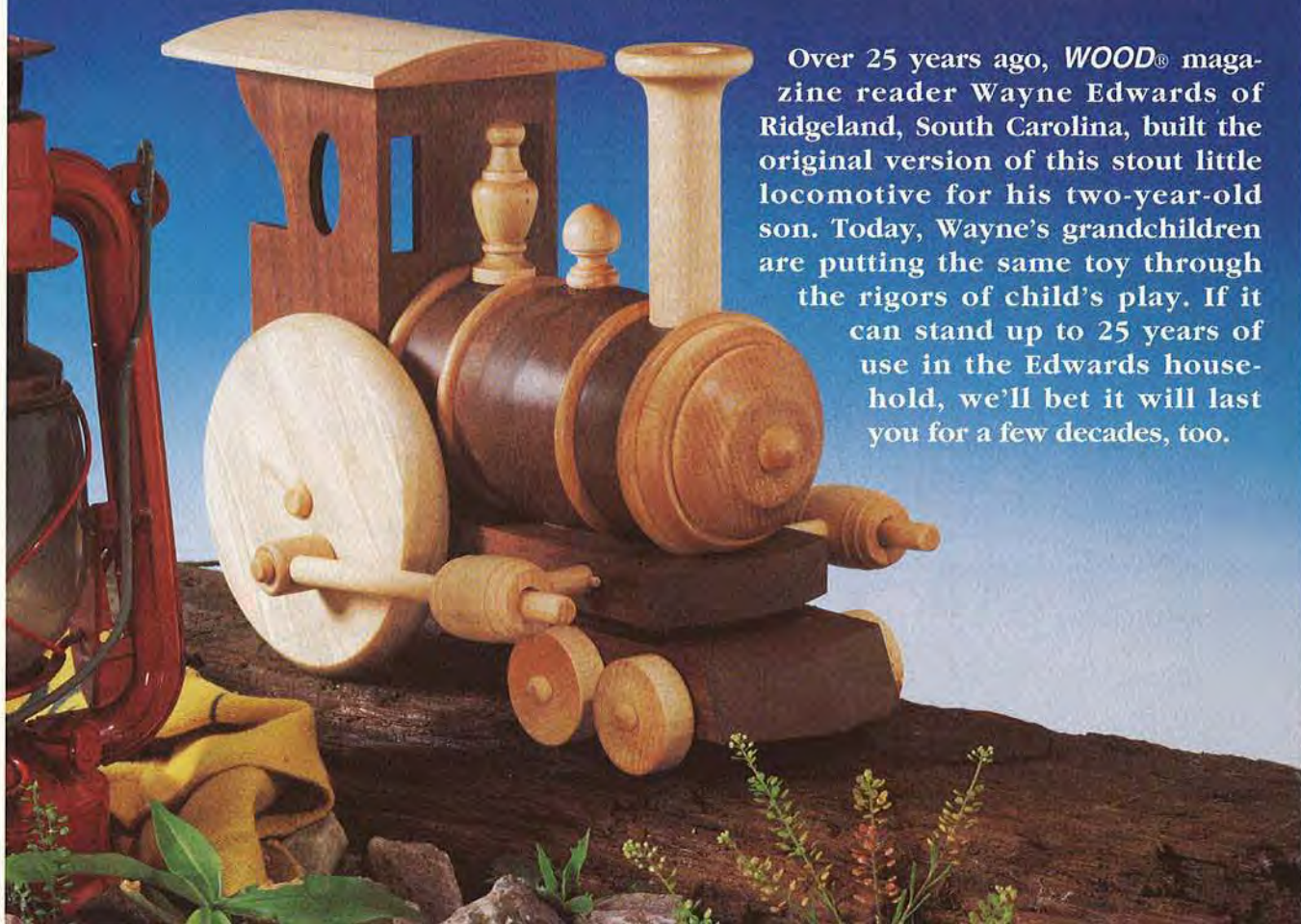

Over 25 years ago, *WOOD*® magazine reader Wayne Edwards of Ridgeland, South Carolina, built the original version of this stout little locomotive for his two-year-old son. Today, Wayne's grandchildren are putting the same toy through the rigors of child's play. If it can stand up to 25 years of use in the Edwards household, we'll bet it will last you for a few decades, too.

Let's get things rolling with the walnut chassis assembly

1 From $\frac{3}{4}$ " walnut, cut the chassis (A) to the size listed in the Bill of Materials. Mark a 3" radius on each end of the chassis where shown on the chassis (A) pattern on the *WOOD PATTERNS*® insert in the center of the magazine. Bandsaw the ends of the chassis to shape. Then, sand the ends smooth to remove the saw marks.

2 Cut the spacer (B) to size from $\frac{1}{4}$ " stock (we resawed this piece from $\frac{1}{2}$ " material), and glue it to the bottom of the chassis where shown on the full-sized chassis pattern on the pattern insert.

3 Cut the cowcatcher (C) to size, but to 12" in length. The extra length is necessary when cutting the beveled front end to shape.

4 Cut the front end of the $1\frac{1}{16}$ "-thick cowcatcher (C) to shape as illustrated on the Cutting the Cowcatcher drawing on the following page. Also, see the full-sized cowcatcher pattern on the pattern insert for reference.

5 Crosscut the cowcatcher to final length ($4\frac{1}{8}$ "), and glue it to the bottom of the spacer (B) where shown on the full-sized cowcatcher pattern. Keep the back end of the cowcatcher flush with the back end of the spacer.

Add a cab to house the conductor

1 Cut the cab floor (D) to size. Glue and clamp it to the top of the chassis (A) where located on the full-sized chassis pattern.

2 Cut the cab sides (E) to size from $\frac{1}{4}$ " stock. Use double-faced tape to adhere the pieces face-to-face, with the edges and ends flush. Transfer the full-sized side pattern from the pattern insert to the taped-together pieces. Drill a $\frac{1}{4}$ " blade start hole, and cut the window to shape. Then, cut and sand the back edge of the cab sides to shape. Separate the pieces and remove the tape.

CHUBBY CHOO-CHOO

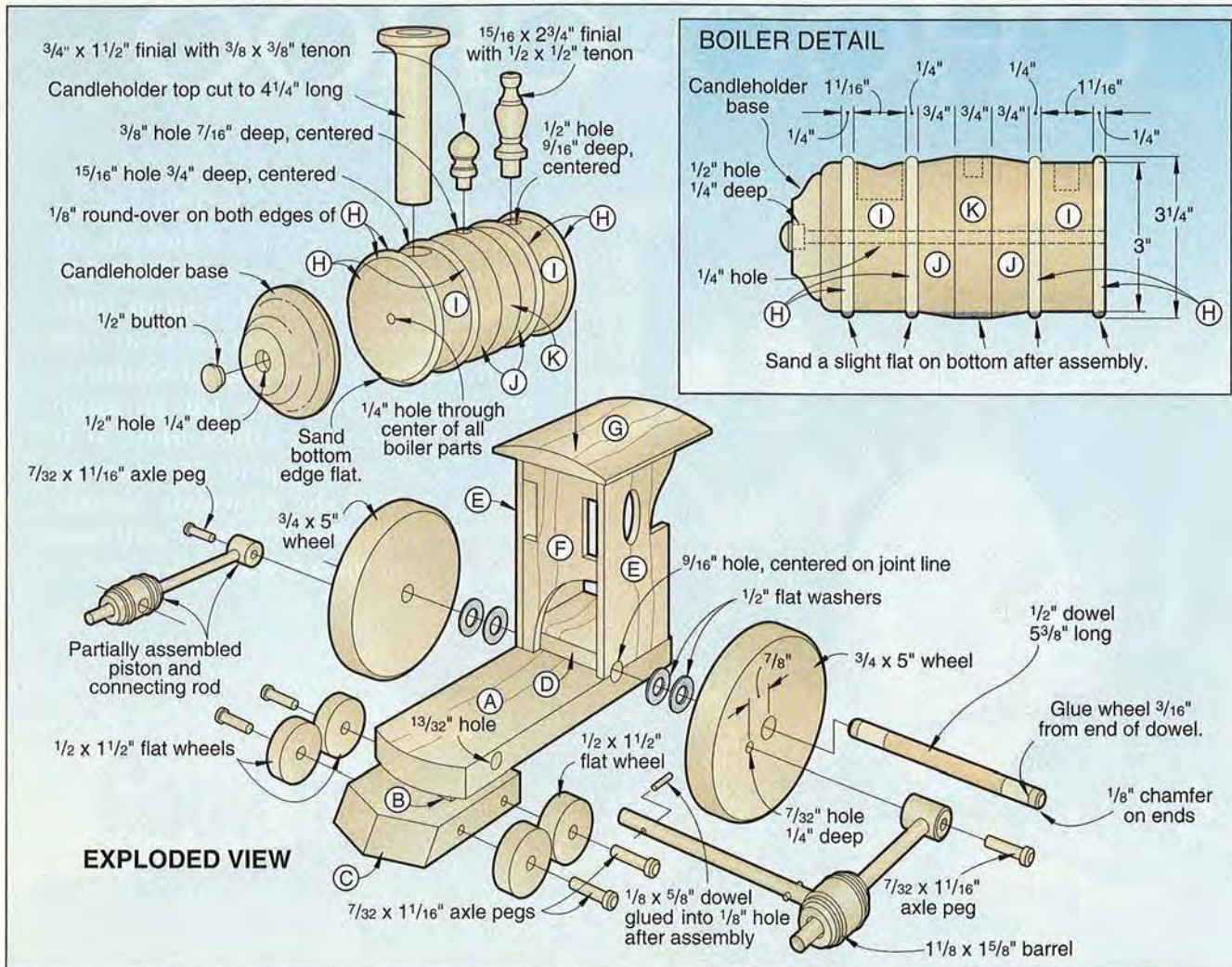

CUTTING THE COWCATCHER

STEP 1 Angle miter gauge and saw blade, and then cut through the auxiliary fence.

STEP 2 Mark a cutline on the bottom side of (C). Align marked cutline with kerf cut in fence, and make the first cut across (C).

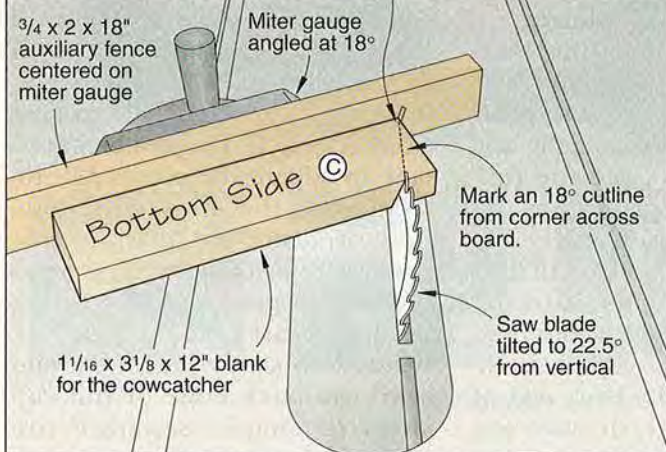

STEP 3 Switch miter gauge to the slot on the left-hand side of the blade, and cut through the fence. Mark a reference line square to one edge, align reference line with kerf, and make the second cut.

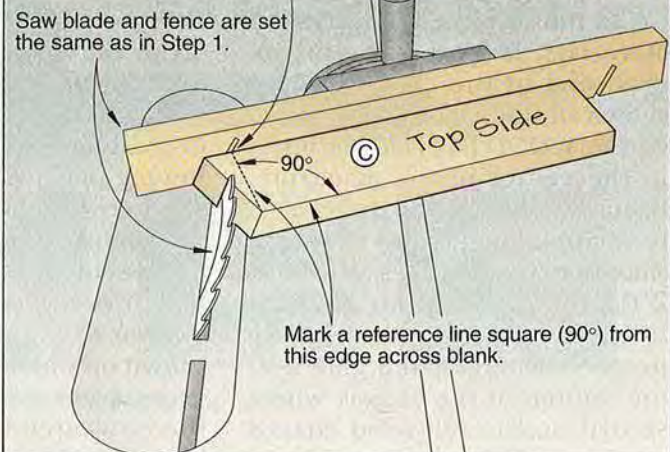

Bill of Materials											
Part	Finished Size			Mati.	Qty.	Part	Finished Size			Mati.	Qty.
	T	W	L				T	W	L		
CHASSIS ASSEMBLY						BOILER					
A chassis	3/4"	3 1/8"	9 1/2"	W	1	H* bands	1/4"	3 1/4" dia.	M	4	
B spacer	1/4"	2"	2"	W	1	I* discs	1 1/16"	3" dia.	W	2	
C* cow-catcher	1 1/16"	3 1/8"	4 1/8"	W	1	J* discs	3/4"	3 1/4" dia.	W	2	
CAB						K* disc	3/4"	3 1/4" dia.	W	1	
D floor	1/2"	2 5/8"	2 3/4"	W	1	*Initially cut parts marked with an * oversized. Trim to finished size according to the instructions.					
E sides	1/4"	3 1/4"	5 3/4"	W	2	Materials Key: W-walnut, M-maple					
F front	3/8"	2 5/8"	5 3/4"	W	1	Supplies: 1/8", 3/8", 1/2", and 3/4" dowel stock, 4-1/2" flat washers, clear finish.					
G roof	1/2"	4"	5"	M	1						

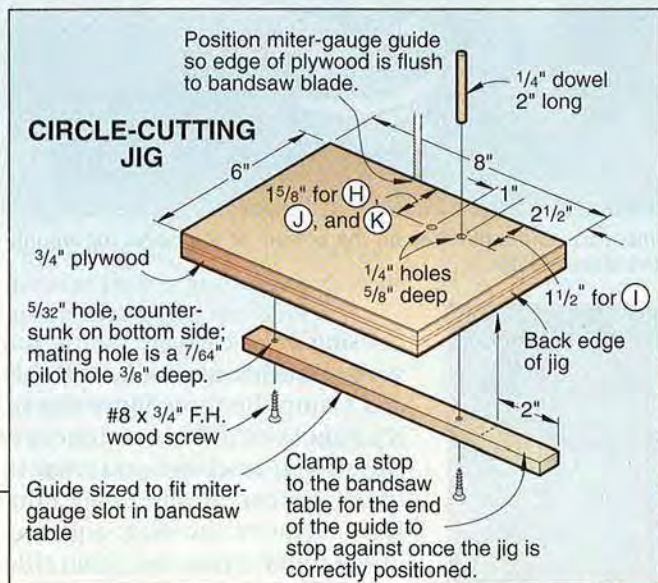

With the square boiler-band blank mounted on the dowel in the jig, slide the jig until it hits the stop, and bandsaw the disc to shape.

3 Cut the cab front (F) to shape. Lay out the notch locations along the edges, and cut them to shape.

4 Glue and clamp the cab sides (E) and front (F) to the floor (D).

5 Carefully lay out the hole centerpoints on the chassis sides (A, C) where dimensioned on the Chassis/Cab drawing on the following page and on the full-sized pattern. Drill the holes where marked. (For support and consistent placement, we used a fence on our drill-press table when drilling the holes. A vernier caliper came in handy when checking the depth of the 7/32" holes in C.)

6 Cut the cab roof (G) to size. Sand the top to the shape shown on the pattern insert, being careful to keep a 1/8" flat area along the edges. (We used double-faced tape to adhere the roof to a 2x4 to act as a handle when sanding.)

7 Center the cab roof side-to-side on the cab assembly, with a 1/2" overhang over the front edge. Glue and clamp (or tape) the cab roof in place until the glue dries.

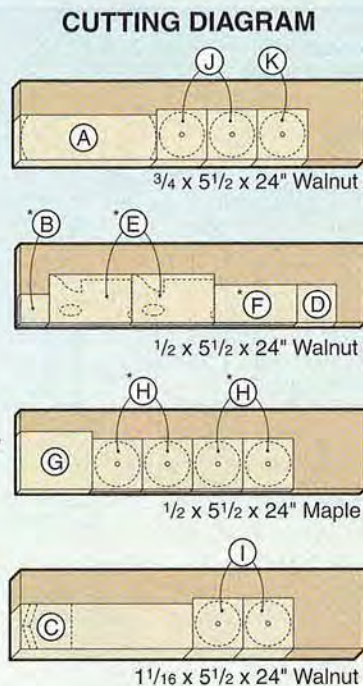

*Plane or resaw to the thicknesses listed in the Bill of Materials.

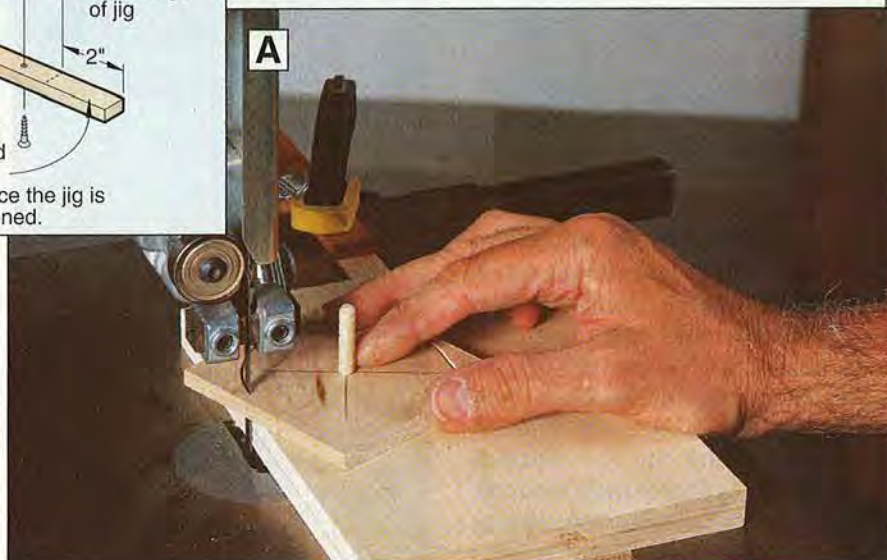

A boiler gives this engine power to spare

1 To form the boiler bands (H) and discs (I, J, K), you can cut the discs freehand or build a circle-cutting bandsaw jig like the one shown on the Circle-Cutting Jig drawing. Cut four pieces of 1/4"-thick maple to 3 1/2" square for the boiler bands (H). Draw diagonals to find center. Drill a 1/4" hole at the marked center of each piece.

Continued

CHUBBY CHOO-CHOO

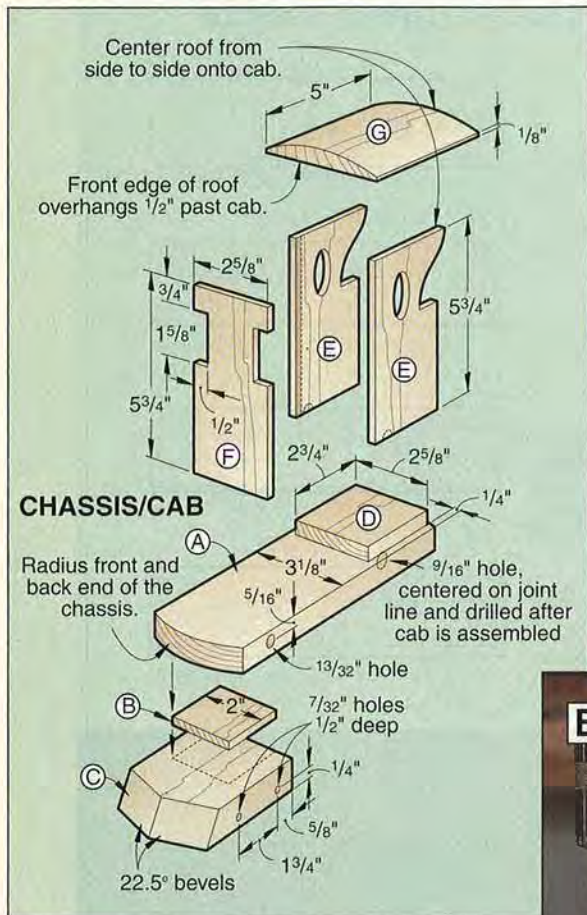

C Use a disc sander to sand a flat area on the bottom of the boiler for mounting the boiler to the chassis later.



B Chuck the threaded end of the carriage bolt into your drill press, and sand the center boiler section smooth.

2 To use our handy jig to cut the discs to near-perfect shape, position the jig on your bandsaw table so the center of the hole being used in the jig is directly across from the center of the blade (we recommend a 1/4" bandsaw blade). Without moving the jig, clamp a stop in the miter-gauge groove directly behind the jig. Mount one of the square boiler-band blanks on the 1/4" dowel in the jig. Start the saw, and push the jig until it comes in contact with the stop. When doing this, you'll have cut into the square blank. Now, rotate the blank to finish cutting the disc as shown in Photo A. Turn the saw off, and remove the disc from the jig. Repeat to form the other three boiler bands.

3 Using 3/4" stock and the jig's 3 1/4"-diameter setting, bandsaw the boiler discs (J, K) to shape. Then,

move the 1/4" dowel to the other hole in the jig, and cut the I parts to 3" in diameter. Note that the I parts are cut from 1 1/16" material.

4 Fit your table-mounted router with a 1/8" round-over bit and a V-notched fence, and rout the edges of the boiler bands (H).

5 Using a 1/4" carriage bolt 4" long with a washer and wing nut, glue and clamp the three inner discs (J, K) together. The carriage bolt allows you to clamp and align the three pieces at the same time. Later, remove the bolt, and use a disc sander, with the table tilted to 12° from horizontal, to sand the edges of each J.

6 To finish-sand the edges of the center section (J, K), remount it to the carriage bolt, and chuck the threaded end of the carriage bolt into your drill-press chuck. Start the drill, and sand the edges smooth, as shown in Photo B. Repeat the process on your drill press to sand the edges of the front and rear discs (I) smooth.

7 Drill a 1/2" hole 1/4" deep centered in the front end of the candleholder base piece used to form the front of the boiler. See the Boiler detail for reference. Then, drill a 1/4" hole through the center of the 1/2" hole.

8 Using a 12"-long piece of 1/4" all-thread rod, glue and clamp the remaining boiler pieces H, I, and the candleholder base to the center boiler section (J, K).

9 steps to great-looking **Half-Blind Dovetails**

Simple dovetail jigs such as the one here help you make tight-fitting half-blind dovetails quickly and easily. Follow these key steps and tricks for using your dovetail jig, and you're sure to enjoy success.

Note: To make your dovetail jig faster and easier to use, build the dovetail jig fence on page 24. If you make a lot of dovetail joints, you'll find that this handy accessory more than pays you back for the small investment in materials and time required to make it.

1 Dovetail jigs come with a template or "comb," with a series of "fingers" that you guide a router along to cut the dovetails. A standard $\frac{1}{2}$ " template works in conjunction with a $\frac{1}{2}$ " dovetail bit, and typically has fingers spaced $\frac{7}{8}$ " apart as shown *right*. However, we've seen some templates with 1" spacing. And, manufacturers offer optional templates with smaller finger spacing. For example, with our Porter-Cable jig we occasionally use a $\frac{1}{4}$ " template that has fingers spaced $\frac{7}{16}$ " apart. Measure the spacing and make note of it.



3 Most likely, your dovetail jig will have a set of stops on both ends that the edges of the workpieces butt against. Set these according to which template you are using.

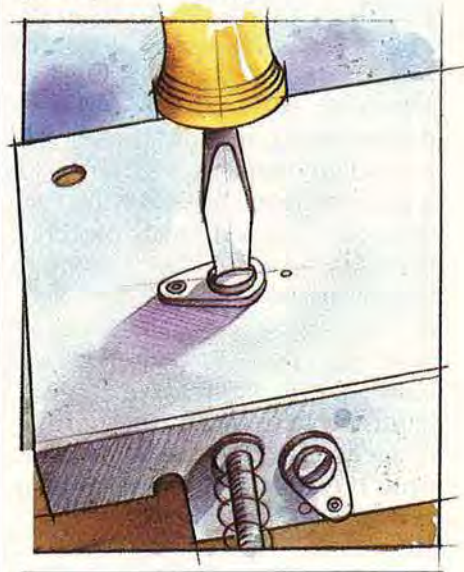

4 Now, select your stock and plane or resaw it if necessary. Drawers typically have $\frac{3}{4}$ "-thick fronts and $\frac{1}{2}$ "-thick sides and backs. With our Porter-Cable jig, the $\frac{1}{2}$ " template requires workpieces at least $\frac{1}{2}$ " thick. The $\frac{1}{4}$ " template works with drawer fronts at least $\frac{3}{8}$ " thick, and sides at least $\frac{5}{16}$ " thick.

Cut your workpieces to size, making sure they are square, and arrange them as shown *below*. Mark the top edges and number all of the matching inside corners.

2 Make the width of your workpieces an increment of the finger spacing. For example, a template with $\frac{7}{8}$ " spacing will work nicely with $3\frac{1}{2}$ "-, $4\frac{3}{8}$ "-, or $5\frac{1}{4}$ "-wide pieces. That way, your workpiece will have equal half dovetails at the top and bottom of the joint as shown *left*.

This also leaves a full tail correctly positioned for a drawer bottom. Plan to center a $\frac{1}{4}$ "-wide, $\frac{1}{4}$ "-deep bottom-holding groove on this tail *after* you machine the dovetails.

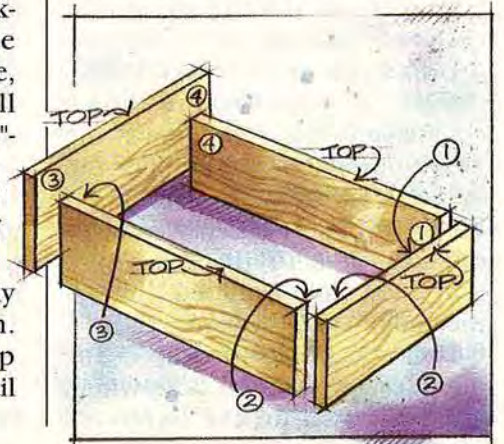
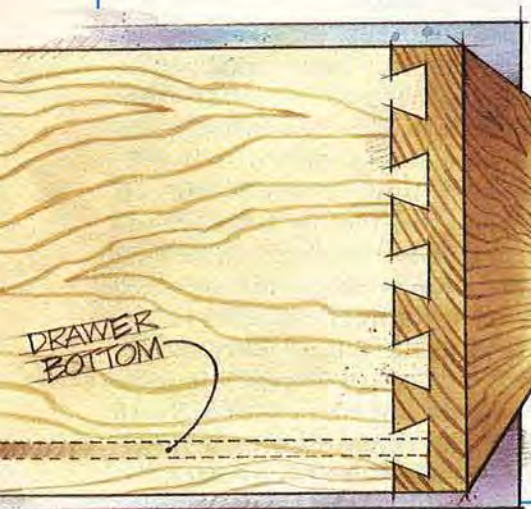

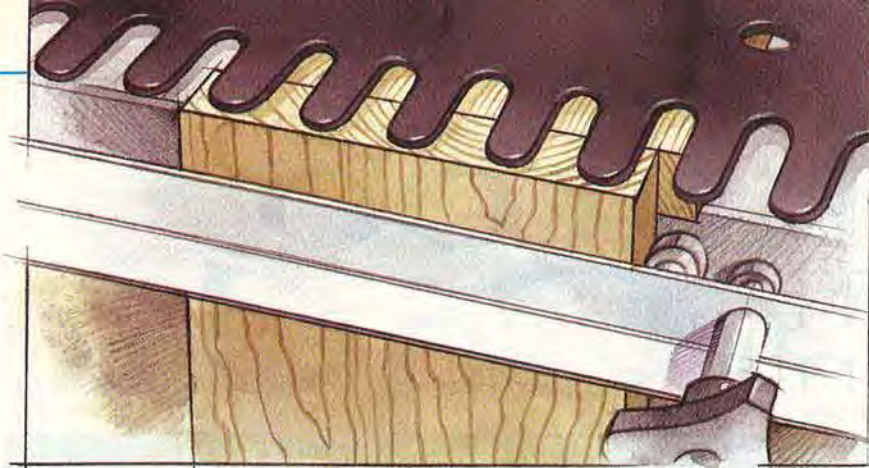

5 Grab two workpieces with same-numbered corners. Place them into the jig with the numbered ends together, the drawer side positioned vertically, and the front or back sitting horizontally as shown *above*.

The inside (numbered) surface of the drawer parts should be facing away from the jig, visible to you. The workpieces should be in contact with the stops, and tight against each other, with the face grain of the horizontal workpiece

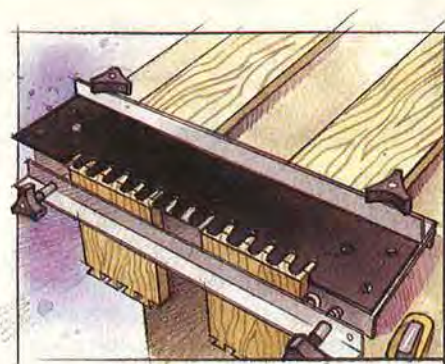

flush with the end grain of the vertical piece.

To speed things up, place workpieces on both ends of the jig as shown *above*. This only works if the width of your pieces is less than half of the jig's capacity.

6 Mount the correct guide bushing into your router's base. Our jig requires a bushing with a $\frac{7}{16}$ " outside diameter (O.D.) when using a $\frac{1}{2}$ " template, and $\frac{5}{16}$ " O.D. bushing for its $\frac{1}{4}$ " template. Secure the necessary dovetail bit, and use a metal rule to adjust its height according to the instruction manual.

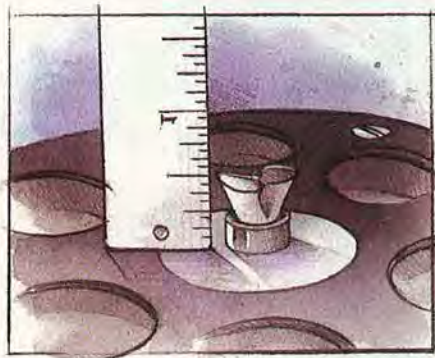

Note: Perform the following steps in scrap stock that's of the same dimensions as your workpieces. After you're satisfied with the results, cut your actual workpieces as described in Step 7.

7 Working from left to right, move the router in and out of each of the template fingers. Go slowly, especially near the ends of the cut, to ensure clean results.

Remove the two workpieces and check their fit with one another. The dovetailed ends should slide together with firm hand pressure or light tapping with a rubber mallet. If the joint requires more force than that, or won't go together at all, decrease the height of the bit and repeat your test cuts. If the dovetails fit together too sloppily, increase the bit height.

8 If you run into grain splintering near the end of the cut, add a scrap piece as shown *below*. The scrap may splinter, but it will help keep the workpiece clean if the two are tightly butted together.



9 Now, check if the dovetails go together so that the face grain of the drawer sides aligns flush with the end grain of the front or back. If they won't align flush, you need to increase the length of the dovetail cuts by adjusting the templates in, away from the router. If the dovetail cuts are too long and the workpieces go more than a hair past flush, adjust the templates out, toward the router. With our Porter-Cable jig, we do this by loosening a holding screw and micro-adjusting a setscrew in or out with a hex key as shown.



Written by Bill Krier with Chuck Hedlund
Illustrations: Brian Jensen

Cockatoo

A bird with lots of cents Cache

Kids love to stash their cash away. That's why we're sure any youngster will welcome this colorful cockatoo as a roommate: This bird conceals a bank under one wing, as shown in the *inset photo*.

Begin with the body

1 Photocopy the Full-Sized Body Pattern (A), in the *WOOD PATTERNS*® insert in the middle of the magazine. Using rubber cement or spray adhesive, adhere it to a 1½×6×10" piece of stock (basswood, poplar, or pine would be good choices for the painted bank). Bandsaw the body.

2 Chuck a ¼" bit in your drill press, and drill through the body at the center mark for the 3½"-dia. hole. Piloting on that hole, bore about halfway through the body with a 3½" hole cutter. Flip the body over, and bore in from the other side to complete the cavity.

3 With a ¼" rabbeting bit, rout a ⅛"-deep rabbet around the hole on the patterned side of the body.

4 Drill a ⅛" pilot hole through the body at the eye location. Guiding on the pilot hole, drill a ½" eye hole about ⅛" deep on each side of the body. Drill a ⅛" hole ¼" deep and a ¼" hole through the body where shown. On the right side of the body, counterbore the ¼" hole ¼" deep with a ⅜" bit.

5 Install a ¼" round-over bit in your table-mounted router. Rout the body on both sides, starting in front of the line marking the front of the notch for the feet. Continue around the body to the tail notch at the back.

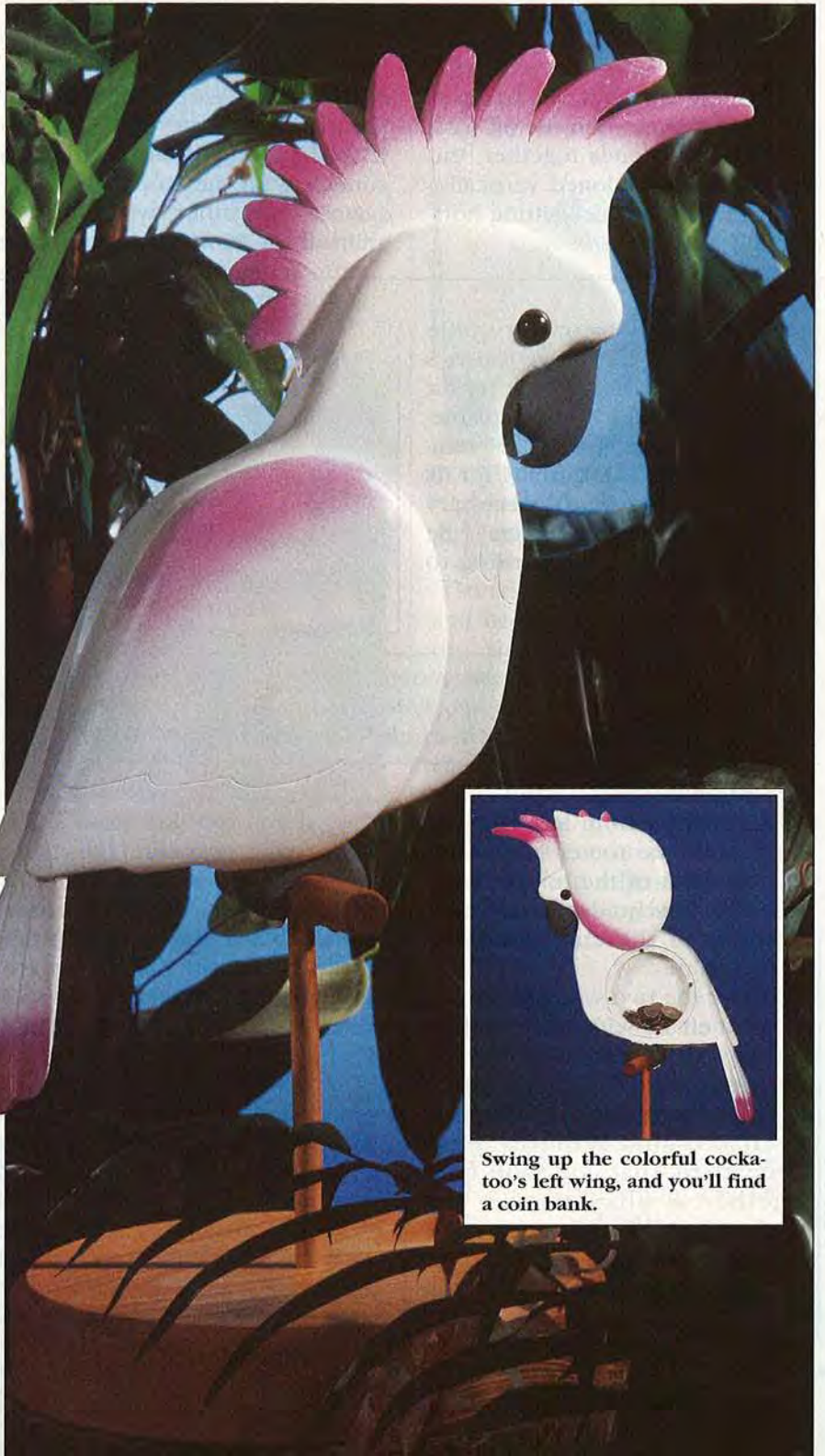

Swing up the colorful cockatoo's left wing, and you'll find a coin bank.

SEE THE
WOOD PATTERNS® INSERT
FOR FULL-SIZED PATTERNS

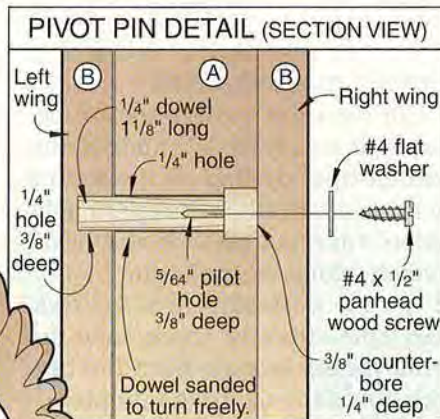

EXPLODED VIEW

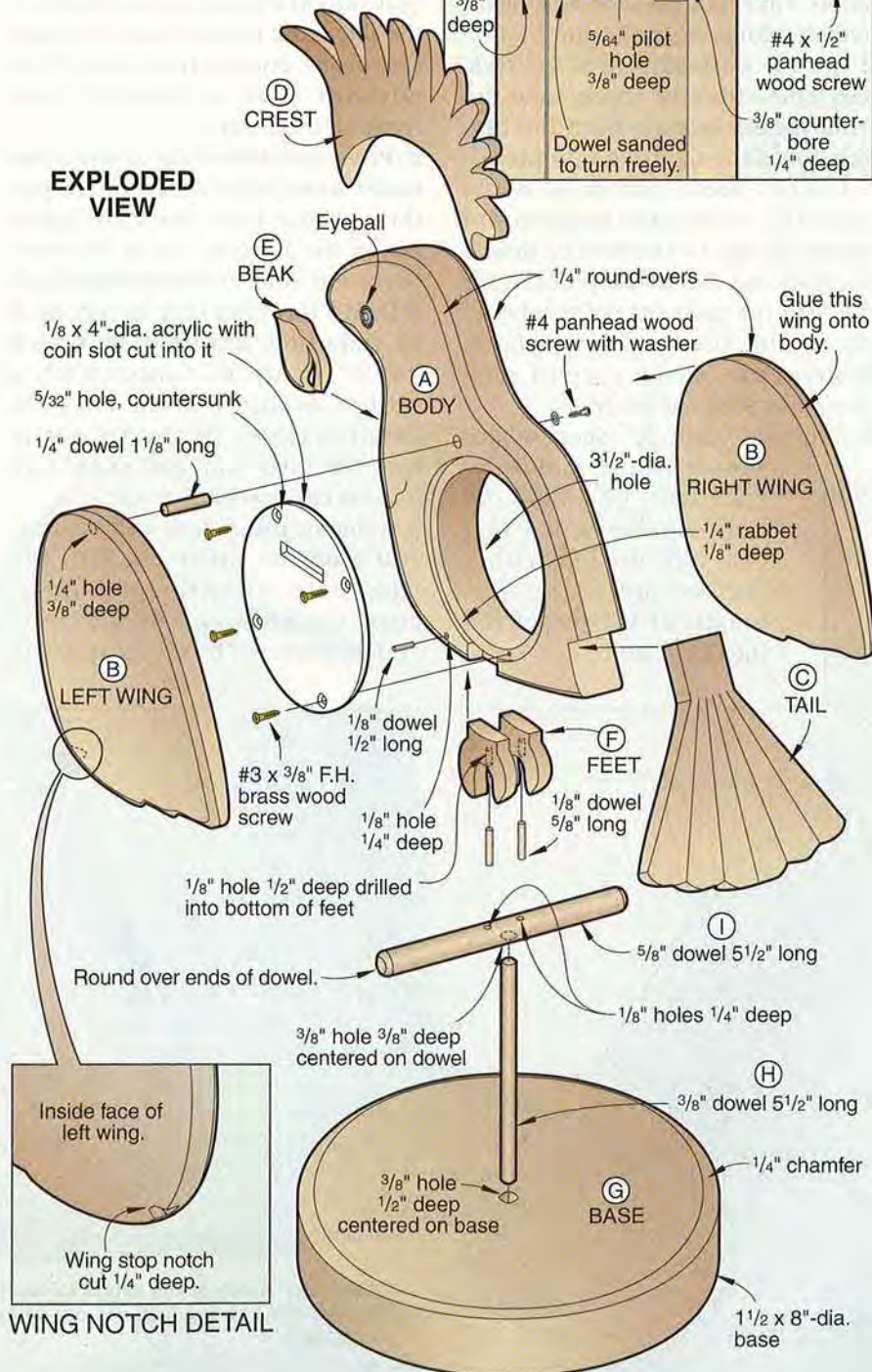

6 Glue a $\frac{1}{2}$ " length of $\frac{1}{8}$ " dowel rod into the $\frac{1}{8}$ " hole on the left side of the body. Sand down the protruding end so it extends about $\frac{1}{8}$ " from the body.

7 Carve a $\frac{1}{16}$ " V-cut along the dotted line at the front of the body to indicate breast feathers. A $\frac{1}{16}$ " V-tool or the corner of a rotary carving burr will make the cut.

8 To make the cover for the rabbeted side of the coin opening, cut a 4"-diameter disc of $\frac{1}{8}$ "-thick clear acrylic. (You could use tempered hardboard or Baltic birch plywood instead, if you wish.)

9 Drill a $\frac{1}{8}$ " blade start hole where shown in the cover's coin slot. Scrollsaw the slot, or drill overlapping holes and file it out. Drill and countersink four $\frac{5}{32}$ " screw holes in the cover where shown.

Shape the wings

1 Stack two $\frac{1}{2} \times 5\frac{1}{2} \times 6\frac{1}{2}$ " pieces of stock together with double-faced tape. Adhere the Wing pattern (B) on page 47 to the top of the stack, and cut out the wings.

2 Separate the cutouts, and designate one the left wing and one the right. On back of the left one, drill a $\frac{1}{4}$ " hole $\frac{3}{8}$ " deep where shown.

3 On the face of each wing that will lie against the body, mark the area shown at the lower back corner of the pattern. Relieve the area by sanding, bringing the wing's thickness at the bottom rear tip to about $\frac{1}{4}$ ". This will allow the wings to clear the tail when installed, as shown by the photo next page. Then, sand the outer face of each wing to shape. Round over the front edge and taper the back, as indicated by the pattern's Cross-section view.

4 Carve a shallow V-groove on the outer face of each wing, where shown by the broken line. Carve $\frac{1}{16}$ " deep with a $\frac{1}{16}$ " V-tool.

Continued

Cockatoo Cache



Turn to the tail

1 Adhere the Tail pattern (C) below to 1/2" stock. Cut out the tail.

2 Taper the top surface to about 1/8" thick at the wide end, carving the tops of the feathers as you go.

To do so, carve a V-groove between the two feathers numbered 1. Then knife-cut each remaining feather line.

3 Employing a shallow carving gouge or a narrow chisel, carve from the center of feather 2 toward feather 1 on each side, going slightly deeper as you approach the knife-cut line. Similarly, carve from feather 3 to feather 2 on each side. This will create a layered appearance, as shown in the detail photo. Carve V-grooves for the feather lines on the bottom of the tail.

4 Glue the tail to the body. After the glue dries, sand the tail and body contours to match. Fill the joint, if necessary, and sand.

Details make the bird

1 Cut the crest (D) from 1/2" stock. Taper it to about 1/8" thick at the feather tips, sanding each side to a gentle curve rather than a straight slope. Glue the crest to the head, straight along the centerline.

2 Cut the beak (E)—or is it a treasury bill?—from 1/2" stock. Sand the front round, starting from the broken line. Glue the beak into place.

3 Cut two feet (F) from 3/8" stock. Sand the front and back round where shown by the broken lines.

4 Chisel out the 3/8"-deep notch for the foot on each side of the body, then glue the feet into place. Position the outside face of each foot flush with the body.

5 Drill a 1/8" hole 1/2" deep where shown in the middle of each foot. (We held the body upside down in a vise and drilled with a cordless drill.) Glue a 5/8" length of 1/8" dowel rod into each hole.

Complete the bird bank

1 Sand the body and wings. Paint white, and apply bright color highlights where shown. Airbrush or aerosol-can application gives the best effect. Apply a clear coating.

2 Now, attach the wings, starting with the pivoting left wing. First, cut a piece of 1/4" dowel rod 1 1/8" long for the pivot pin. Insert one end into the hole on the back of the left wing (do not glue it). Sand the other end to turn freely but without play in the 1/4" hole through the body.

3 Press the left wing against the body side with the pivot pin through the hole. Mark the pivot pin at the bottom of the counterbore, and cut it to that length.

4 Drill a 5/64" pilot hole in the sanded end of the pivot pin. Drive in a #4x1/2" panhead screw with a washer, as shown in the Pivot Pin Detail drawing. Be careful not to split the pivot pin, and make sure it turns easily with the screw in.

5 Remove the screw and washer, and glue the pivot pin into the wing hole. After the glue dries, install the left wing with the screw and washer. Then, scrape the

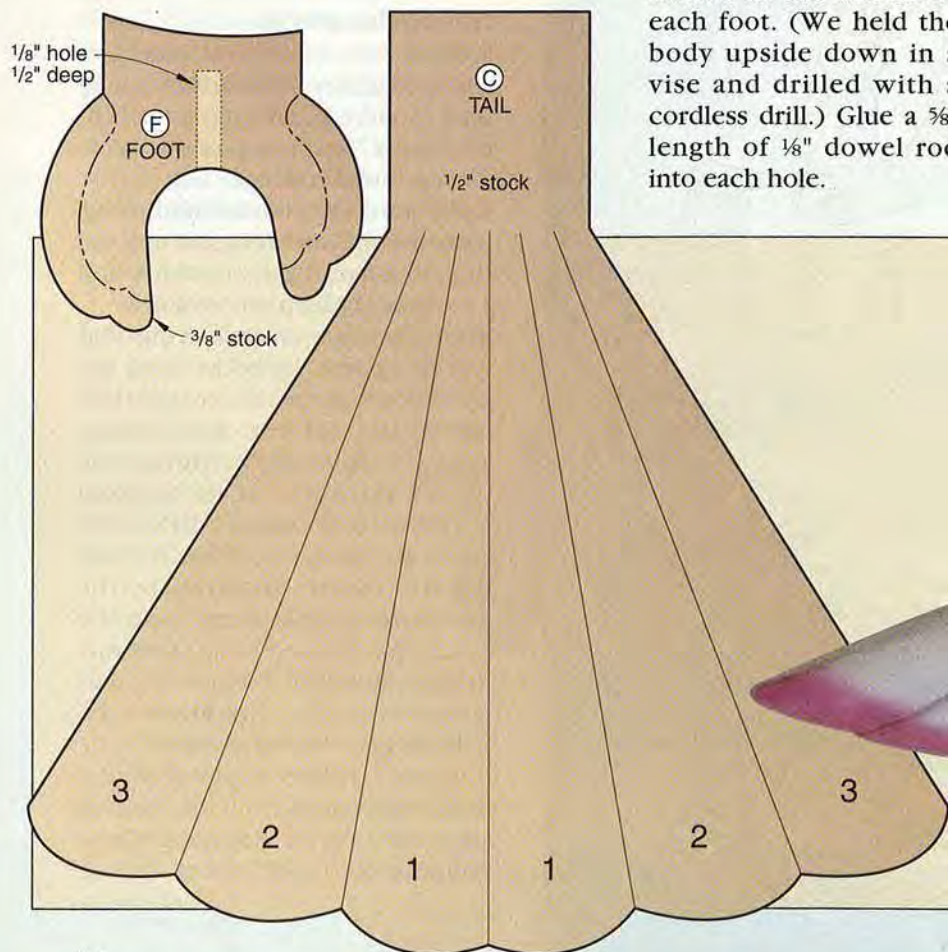

Shape the inside of the wings to clear the tail. Fan the tail feathers out from the middle.

paint from a few mating spots on the back of the right wing and the right side of the body, and glue the right wing into place.

6 Swing the left wing down until it contacts the stop dowel. Mark the contact point, then carve the stop notch into the underside of the wing, shown in the Wing Notch Detail drawing.

7 Glue in the eyes. (We used black plastic eyes from a craft shop; black-painted buttons would work, too.) Position the plastic cover in the rabbeted opening. Drill $\frac{1}{16}$ " pilot holes, and secure the cover with four #3 $\times\frac{3}{8}$ " flathead brass wood screws.

Build the perch

1 Scribe an 8"-diameter circle on $1\frac{1}{2}$ "-thick stock for the base (G).

Bandsaw the base. Saw outside the cutting line, then sand down to it.

2 Rout a $\frac{1}{4}$ " chamfer around the top edge. Drill a $\frac{3}{8}$ " hole $\frac{1}{2}$ " deep at the center. Sand the base.

3 Cut a $5\frac{1}{2}$ " length of $\frac{3}{8}$ " dowel rod for the upright (H) and a $5\frac{1}{2}$ " length of $\frac{5}{8}$ " dowel rod for the crossbar (I). Drill a $\frac{3}{8}$ " hole $\frac{3}{8}$ " deep at the center of part I.

4 Glue the crossbar (I) to the upright (H). Then, glue the assembly into the base hole.

5 Lay a piece of carbon paper across the stand's crossbar. Then, slide the cockatoo's feet down onto the crossbar—making sure the bird is centered—and press down so the dowels in

the feet make carbon-paper marks on the crossbar. Drill a $\frac{1}{8}$ " hole $\frac{1}{4}$ " deep at each mark.

6 Sand and finish the stand. You could paint it or, as shown, stain it and apply a clear finish. After the finish dries, position the cockatoo on its perch, engaging the dowels in the feet into the holes in the crossbar. For greater stability, glue the feet to the crossbar. 🐦

Project Design: Raccoon River Scrollworks, P.O. Box 41308, Des Moines, Iowa 50311-0506
Photographs: John Hetherington
Illustrations: Kim Downing; Lorna Johnson

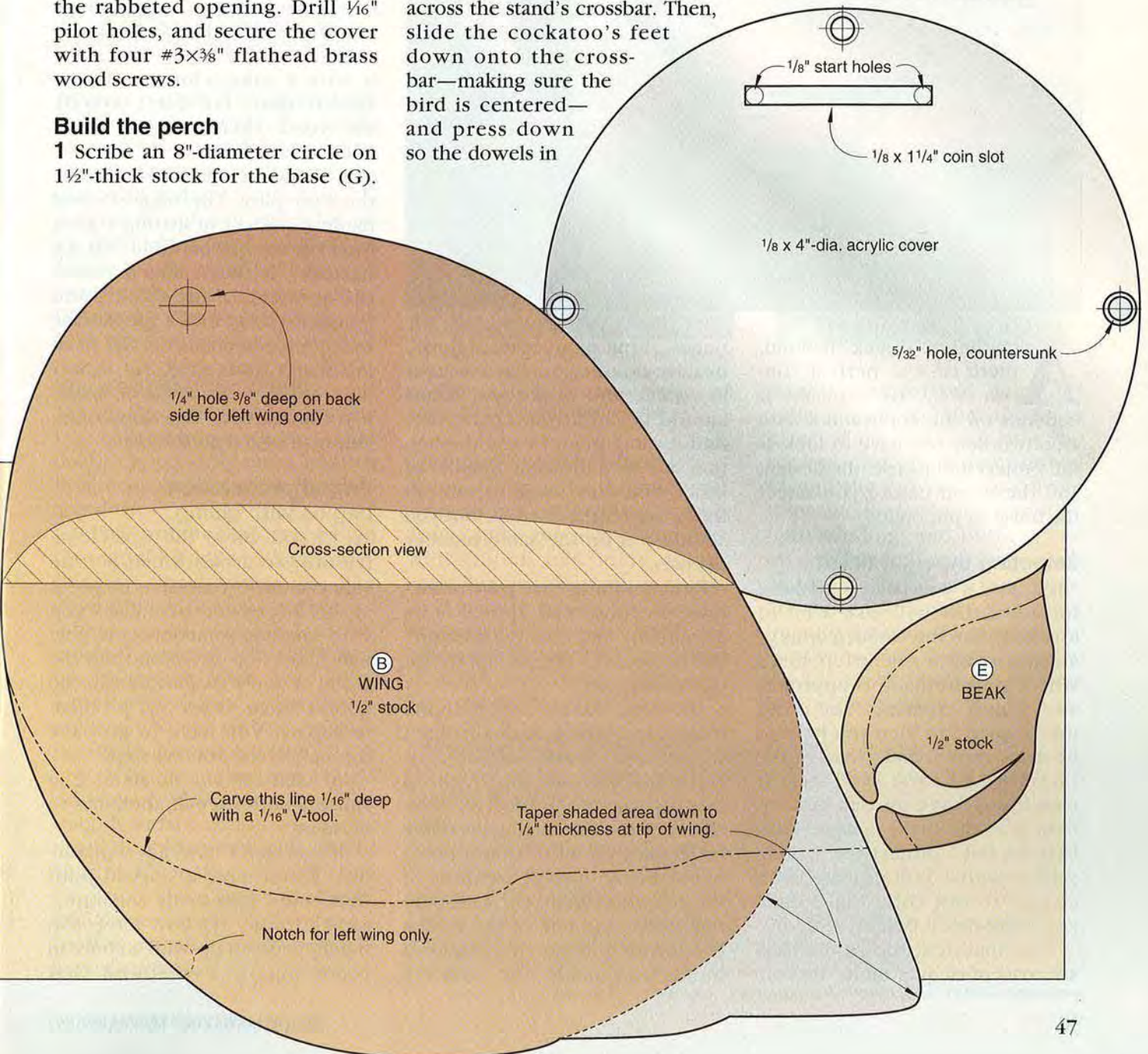



A PRO'S POINTERS

Chuck Hedlund, *WOOD*® magazine's project builder, gives you his tips for getting a great finish.



periodically you do have to give the piece another coat to keep up the protection."

What about water-based finishes? "Water-base has more of a natural look on the wood. It doesn't give it a yellow cast, which takes some people a while to get used to," says Chuck. "The trouble with water-base is that it raises the wood grain, making more work for you in the application. Sometimes what helps, though, is to first sand the wood, then wipe it with a damp cloth, and then sand it again. But don't saturate the wood. There's only so much grain to raise."

Choosing the right finish is really the easy part. The biggest—and hardest—aspect of getting a great finish is the preparation, Chuck believes. "It's like painting a car—the spraying is the easiest and quickest thing. But if the surface isn't prepared correctly, the paint job won't look good. No matter how well you can spray or brush, if you don't prep the wood right, you won't get a great finish."

Proper preparation begins with gluing

To Chuck, about the worst contributor to a bad finish is glue squeeze-out. "You have to get it all off the wood because even with sanding, sometimes the glue only shows up after you stain the wood or apply the final finish," he notes. "Then, it's a real problem to repair. You have to go back through all the sanding steps."

So, what can you do about glue squeeze-out? After all, there has to be some.

"If you don't have any squeeze-out, you'll have a starved joint that could eventually separate," says Chuck. "If you have too much, you end up with a chore in removing it. I've found that

According to Chuck Hedlund, there isn't a "perfect" finish. Why? He explains: "It depends on the application. As a woodworker, you have to look at the project and its use, the design, and the wood before you select the finish to put on it."

Selecting the right finish

"Basically, if you have a piece of furniture that will take a lot of touching, like the wooden arms of a dining chair or a table top, that's where polyurethane is appropriate," Chuck explains. "You could use lacquer, but then you have to be more careful and aware of the finish because you can't treat it roughly. I have an oak rolltop desk at home that I sprayed with lacquer, but I protect the writing surface with a desk pad and use a coaster to rest cold drinks on. I also paste-wax it twice a year.

"And that desk top has at least six coats of lacquer on it," he con-

tinues. "I put more coats of finish, usually double, on flat surfaces like table and desk tops. Edges should get multiple coats, too. And it's important to seal the bottom side with the same number of coats. You don't have to rub out the finish on the bottom, but you should put on the same number of coats."

Chuck admits that part of lacquer's widespread appeal is its sprayability and fast-drying nature. But he believes there's a place for oil finishes, too.

"Oil [tung, Danish, etc.] is appropriate on anything made of what I call 'elegant' wood, such as cherry, black walnut, and figured maple," says the project builder. "Sure, you can put polyurethane or lacquer on all of them, but it won't bring out the richness of the color and grain. Oil soaks into the wood, and one of the easiest is Minwax Antique Oil because it builds up quickly. But with oil,

FOR PREPARATION



Here's what the squeeze-out of a good glue line should look like. Chuck removes it with a chisel before it's dry.

squeeze-out the size of a pencil lead is just about right. [See photo above.] I wait until the squeeze-out thickens, then I lift off the glue with a chisel, putty knife, or scraper. If you wait and let it set up overnight, you risk pulling off some of the wood when you remove it because the glue bonds. Unless you plan to resand the surface, you don't want to let it dry."

You can sand too much

Don't skip a grit is a woodworking commandment. Yet, that doesn't necessarily mean sanding progressively through all the abrasive grits.

"The number of grits I go through depends on the circumstances," Chuck comments. "For example, with penetrating oil where you'll actually feel the wood through the finish, you'll normally want to go from 80 to 320. But if you use a lacquer or poly, which are surface finishes that build up, you can stop at 150 grit. Of course, if you have a thickness planer that puts out a nice smooth surface on the wood, you might be able to start with 120- or 150-grit. If you don't need 80, stay away from it and any coarser grits. That's because any time you use a coarser grit you're visibly scratching the surface.

"However, no matter with what grit you start, don't skip a grit because it will just take longer to remove the scratches from the previous one," Chuck cautions. "And if you plan to stain the wood, remember this: The coarser the sandpaper you end up with, the darker the surface will stain; the finer the grit, the lighter the stain will be. That's because pigment collects in open pores."



To remove a messy run of finish requires scraping the excess with a chisel, light sanding, and then buffing the area with a polishing compound.

One good way to brush

Many, if not most, home woodworkers rely on their hands rather than a spray gun to apply finishes. And Chuck has some advice regarding that. "Buy a quality, natural bristle brush for lacquer because the better the brush, the better the result. There's nothing more irritating than a bristle coming out on the final stroke. To

brush poly or a water-based finish, you can use a disposable foam brush [lacquer eats foam]."

So, how do you start? "I usually start in the left corner away from me and bring the finish to my right, working from back to front," says Chuck. (See below.) "That's so I don't drop anything onto the fresh finish by reaching across the full width."

After applying the finish, Chuck inspects the piece for areas he

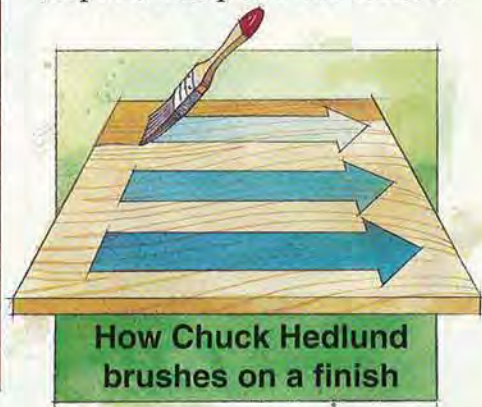

might have missed or didn't apply enough to. After the finish dries, if he finds any runs, he scrapes and sands them down. "About the only way to correct imperfections is with scraping, light sanding, and buffing," he says, then adds some final words of advice. "Don't get in a hurry. Finishing takes time. You put a lot into making the project, so spend the time necessary to finish it correctly, even if it takes as long as the building." ♣

More great finishing tips from Chuck

- Use cotton swabs to spread finish into corners and crevices, and to unclog dowel holes.
- Remove the back of a cabinet before spraying. Take off handles and anything else that you can remove.
- Stuff cotton balls in any dowel holes yet to be filled.
- Keep stains stirred throughout application.
- Don't let stain dry before wiping it off. Always keep a wet edge. On a large surface, first stain two-thirds and then wipe it down.

ARCHED-TOP Wall Shelf



Want to add a little sparkle to a ho-hum entry or brighten up a dreary hall? If so, you're going to love this simply elegant shelf. All it takes is a tablesaw, jigsaw, sander, and an evening or two of your time. It's that simple.

Start with the plywood back and side pieces

1 Cut a piece of $\frac{1}{2}$ " plywood to $12\frac{1}{2}$ " wide by 34" long for the back (A) and two pieces to $5\frac{1}{8}$ " wide by $22\frac{1}{2}$ " long for the sides (B). (Because it has more plies and is void free, we selected Baltic birch plywood for this project. Select your own stock, or see the Buying Guide for our source of this quality plywood.)

2 Cut the pattern pieces for the full-sized mirror and back (A) from the *WOOD PATTERNS*® insert in the center of the magazine. Note that the pattern comes in two pieces, and that you'll have to tape a $16\frac{5}{8}$ " piece of paper between the patterns. Then draw lines to connect the patterns and add the middle horizontal piece. Trace the full-sized mirror pattern from this paper pattern. The paper pattern gets destroyed when cutting the back to shape.

3 Transfer the full-sized back (A) and side (B) patterns to the respective stock. Drill a blade start hole inside each marked opening.

4 To cut the openings in the back (A) and sides (B), use a scrollsaw if you have one with a large enough throat. If not, use a jigsaw to cut the pieces to shape as shown in the photo *at right*. (We used a jigsaw fitted with a Dewalt trim/coping blade, #3715 for the curved cuts and a Dewalt fine cut/smooth finish #3710 blade for the straight cuts. If you have a

A delightfully different showcase for prized collectibles

jigsaw requiring a bayonet-style blade, we recommend the AEG 254061 jigsaw blade. (A quality blade is important to minimize chipping when making the cuts.) See the box at the end of the article for three tips on making smooth cuts with a jigsaw.

5 Using the one side piece cut to shape as a template, transfer the pattern to the second piece of plywood, and cut it to shape.

6 After the cuts are made in the back and sides, remove the patterns, and fill any voids (we recommend Durham's Rock Hard Putty). Sand each opening.

It's time to cut the dados and grooves

1 Fit your tablesaw with a $\frac{1}{4}$ " dado blade, and cut $\frac{1}{4}$ " dados $\frac{1}{4}$ " deep in the sides (B) where dimensioned on the full-sized pattern and Exploded View drawing.

2 Switch blades and cut a $\frac{1}{2}$ " groove $\frac{1}{4}$ " deep along the back inside edge of each side (B) where

Continued

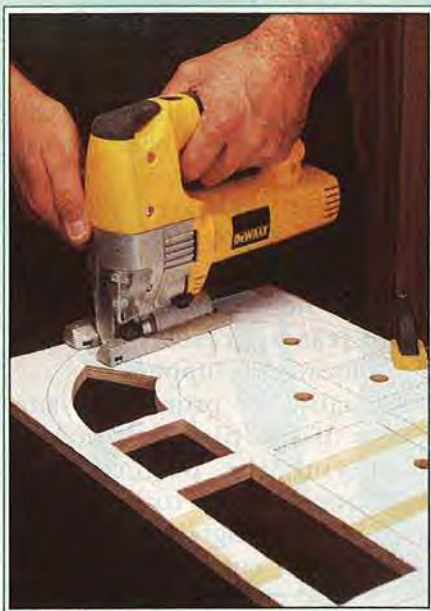

Drill blade start holes, and then cut the marked openings on the plywood back to shape.

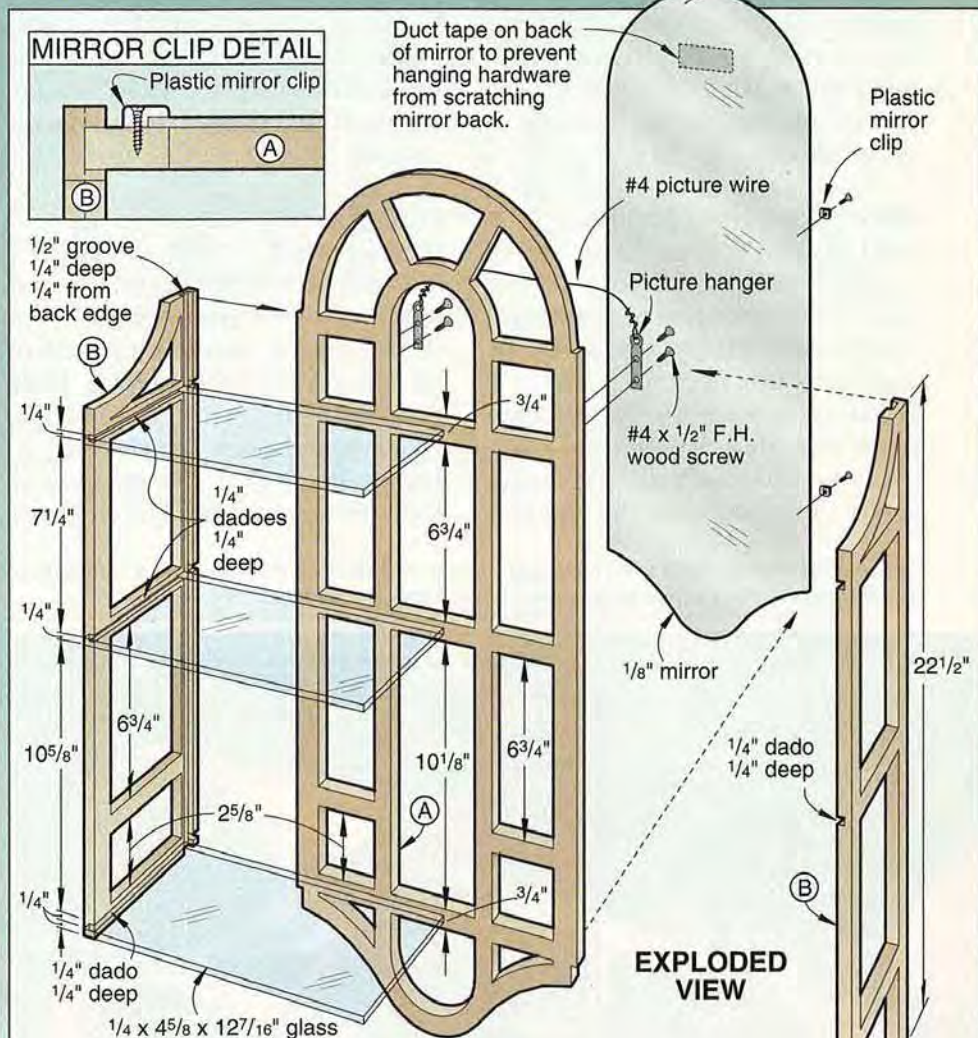

Bill of Materials					
Part	Finished Size			Matl.	Qty.
	T	W	L		
A* back	$\frac{1}{2}$ "	$12\frac{1}{2}$ "	$32\frac{5}{8}$ "	BP	1
B sides	$\frac{1}{2}$ "	$5\frac{1}{8}$ "	$22\frac{1}{2}$ "	BP	2

*Initially cut parts marked with an * oversized. Then, trim each to finished size according to the how-to instructions.

Material Key: BP—Baltic birch plywood.

Supplies: 3— $\frac{1}{4}$ x $4\frac{5}{8}$ x $12\frac{7}{16}$ " glass for shelves, $\frac{1}{8}$ x 1 x $31\frac{1}{8}$ " mirror, 2 picture hangers with screws and #4 picture wire, 6 plastic mirror clips with screws, primer, paint.

Buying Guide

Hardwood kit. All of the pieces shown on the Cutting Diagram cut slightly oversized from $\frac{1}{2}$ "-thick Baltic birch plywood. W951, \$24.95 ppd. Heritage Building Specialties, 205 North Cascade, Fergus Falls, MN 56537. Or call 800/524-4184 to order.

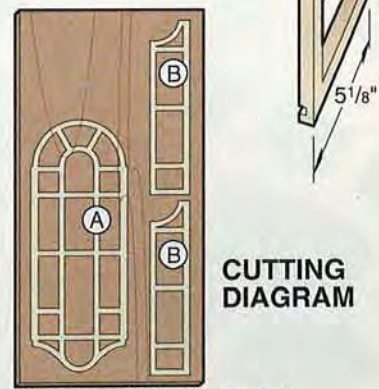

$\frac{1}{2}$ x 24 x 48" Birch plywood

SEE THE
WOOD PATTERNS®
INSERT FOR
FULL-SIZED PATTERNS

Wall Shelf

shown on the Exploded View drawing. (We cut scrap stock first to ensure the width of cut was equal to the thickness of the plywood used.) Adjust your blade until the mating back piece (A) fits snugly inside the groove in each side (B).

Assemble the pieces, and check for square

1 Slide the back (A) into the $\frac{1}{2}$ " grooves in the mating sides (B). Temporarily clamp the assembly together, and check for square.

2 Carefully measure the distance between dados in the side pieces, and cut two pieces of scrap to fit between the sides to

hold them parallel to each other and square to the back (A).

3 Glue and clamp the sides to the back as shown in the photo *below*. Use the spacers to hold the assembly square until the glue dries. Remove the clamps and spacers. Finish-sand the assembly.

Add the shelves, mirror, and finish

1 Use a piece of hardboard or cardboard to form a template for the $\frac{1}{8}$ " mirror. Measure the size of glass and mirror cut to shape. (We had our glass shelves cut $\frac{1}{16}$ " less in length than the opening so the shelves would slide in place

easily. We also had the shelves cut $\frac{1}{8}$ " wider, front-to-back than the opening so the shelves protruded slightly from the front of the wall-shelf sides.)

2 Before painting, check to see that you have filled all the voids and that you have sanded all the surfaces. Prime the project, and then paint it to the desired color.

3 Using the Mirror Clip detail, secure the mirror to the back side of the plywood back (A).

4 Add a pair of picture frame hangers and wire to the back of the assembly. Add a piece of duct tape to the back of the mirror so the hanger doesn't scratch the silvering. Hang the project, add the glass shelves, level the shelf, and add your collectibles. ♣

Use two spacers to hold the sides square to the back until the glue dries. Clamping blocks prevent the project from being marred when clamping.

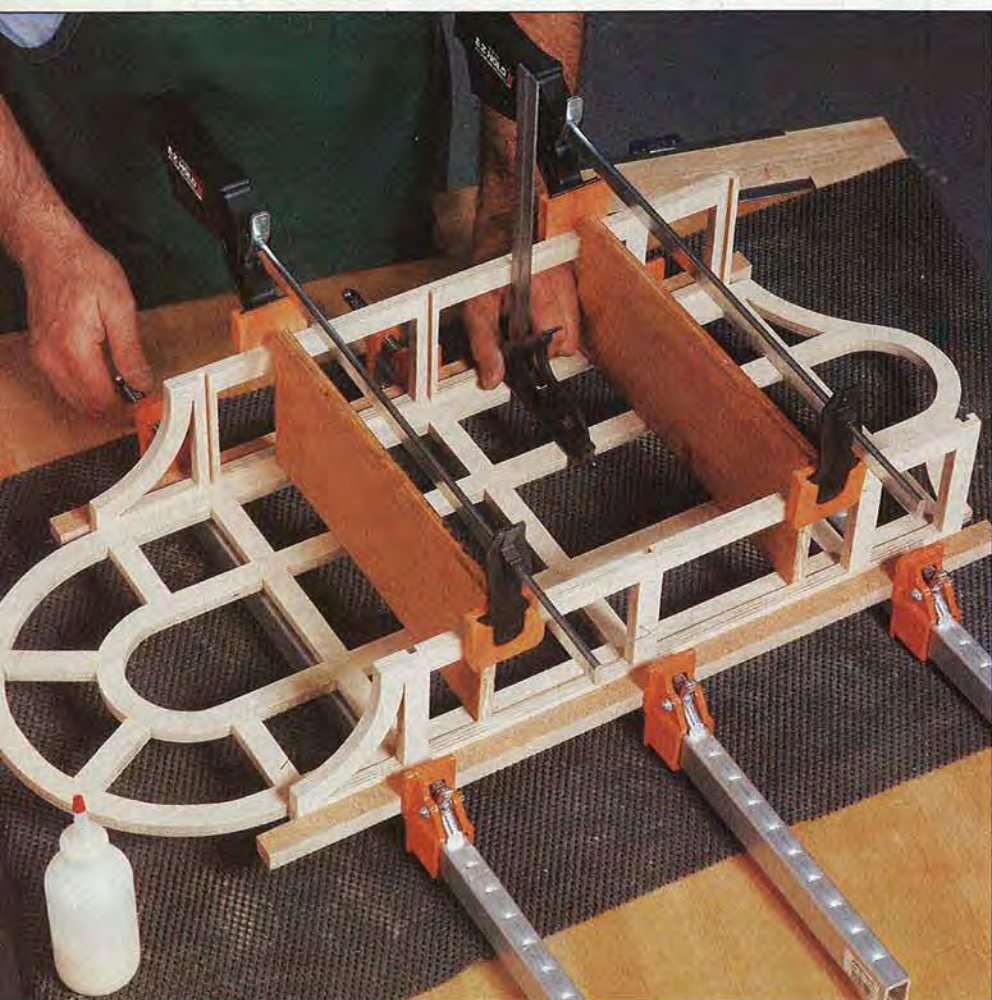

3 tips to ensure smooth jigsaw cuts

1 After selecting a jigsaw blade, cut a piece of scrap stock from the same material as the back and sides, and check for smoothness. We noticed that one side of the blade cut smoother with less chip-out than the other. With this in mind, we used the good side of the blade to cut next to the marked pattern line and the poorer side of the blade on the waste side of the stock.

2 Also, if you have an adjustable jigsaw, set it so the blade cuts straight up and down and not in the orbital motion. This is a less aggressive cut and results in less chipping.

3 Finally, we primed the surface of the plywood before applying the pattern. The primer seemed to bond the wood fibers slightly, making for a smoother cut.

Written by Marlen Kemmet
Project Design: James R. Downing
Illustrations: Roxanne LeMoine; Lorna Johnson
Photographs: Hopkins Associates

Rip Fences

What you need to know before upgrading

You say you're not getting the results you hoped for from your tablesaw? The problem may be its fence. Fortunately, there's a whole fleet of high-quality rip fences capable of transforming any tablesaw into a precision cutting machine. Read on to find out what we discovered about the 21 models we tested.

Fast Facts

- All of today's high-quality fences will improve greatly the performance of a tablesaw outfitted with a standard, low-cost fence. If your tablesaw has a cast-iron top and an induction motor, it probably makes sense to upgrade your saw with one of the fences reviewed here.
- Most high-end tablesaws already come with one of the fences reviewed here, or offer you the option of choosing among several of these fences when buying the saw.
- You can save up to \$75 by buying one of the down-scaled versions that we found plenty accurate and suitably durable for most part-time woodworkers.

Rip Fences

First things first—do you need a new fence?

Rip fences of the quality reviewed in this article have become standard equipment on most tablesaws priced over \$1,000—with good reason. High-quality fences help bring out the full potential of any table-saw—high *or* low-priced—by making it more accurate and convenient to use. Here's what to consider before taking the plunge:

- As our hands-on tests show, a high-quality fence will remain parallel to the blade cut after cut. The same cannot be said for most standard, lesser-quality fences. A fence that doesn't reset itself parallel to the blade contributes mightily to poor-quality cuts, and the possibility of workpiece kickback.

- High-quality fences cost \$210 to \$420 as an aftermarket item, and will add nearly that much to the cost of a new table saw.

- If you work with wood for several hours or more every week, you'll appreciate the speed and convenience of a built-in tape measure. All of the tested units have hairline cursors on the fence that you align with a tape measure mounted on the front rail. Doing this is much faster than pulling out a tape measure and checking the blade-to-fence distance for every cut.

Do you need a rear-locking fence?

All of the tested fences lock in front, and several also lock to a rear rail. In the *WOOD* magazine shop we use fences that lock only in the front. We've never had a problem with the back end of the fence lifting or deflecting. But, we don't use a power feeder, stock hold-downs, or a scoring blade. If you do, you should consider a model with a rear lock. Or, you can simply clamp the rear of any of the tested fences if the need arises. All in all, we don't find a rear-locking device to be an essential feature.

Your product choices close-up

Biesemeyer and its clones

- Biesemeyer.** The Biesemeyer T-square is the original aftermarket rip fence, and it has the greatest name recognition in this category. As shown *below*, a Biesemeyer fence has two heavy angle irons that bolt to the front and back edges of a table saw. These help support an extension table on the side of the table saw, and the front rail provides a rigid mounting surface for the front tube. The fence pinches against the front tube when you lock it in place by lowering its lever.

Biesemeyer, like several other brands, offers a down-sized version of the "commercial" model shown here. These "home shop" fences have slightly less beefy components and shorter fences, but are accurate, and built plenty well for the dedicated wood-working hobbyist.

Biesemeyer's no-nonsense, all-steel construction and years of proven service have made it a top-selling aftermarket fence. It's no wonder, then, that it has recently been imitated with varying results by General, Jet, Powermatic, and Modulus. Let's look at those models.

- General.** We could find no major differences between the fences offered by General and Biesemeyer.

- Jet.** The Xacta commercial and home shop fences closely mimic the Biesemeyer fences, with a couple of modifications. In place of the plastic-laminated plywood faces on a Biesemeyer fence, the Jet fences have slick plastic faces made of high-density polyethylene. The Jet faces are easier to replace because they have accessible screwheads. With Biesemeyer faces you have to remove the laminate to access the screws. Despite this advantage, we prefer the Biesemeyer faces because we found that they wear longer and mar less easily than the Jet faces. The Jet rails and tube are made from slightly thinner steel than the corresponding parts on the Biesemeyer fences we tested.

- Powermatic.** Although the Accu-Fence Commercial model appears to be a copy of the Biesemeyer Commercial model, it features two improvements. First, as shown on the *right* side of the photo *right*, it has T-slots milled into the back sides of the fence faces, and nut-access holes in the underside of the fence body. These allow you to easily change faces without tearing off the plastic laminate.

Like the Biesemeyer locking handle, the Powermatic handle releases the fence completely





Vega Pro fence

when you pull it up, and locks the fence when you push it down. But, the Powermatic fence has an intermediate position that holds the fence parallel to the blade as you fine-tune its position by tapping it to the right or left slightly before locking.

•**Modulus.** You can purchase three similar fences from this company. They come with rails and front tube, or without them (in case you already have Biesemeyer rails and tube). All three models have a mechanism that locks the rear of the fence to the back rail. If you already own

a Biesemeyer fence, you can add the Modulus rear-locking kit for \$79.95 list. (For more discussion on rear locks, see the section "Do you need a rear-locking fence?")

If you frequently work with sheet goods, and have had times when you wish you could position the fence farther to the front or back of the sawblade, you should take a look at the largest Modulus model, the SSF-100. It has a 60"-long fence that slides forward and back. As shown *below*, a mechanism within the fence body controls the sliding motion, and front knobs lock the fence in place.

•**Vega.** The Vega Pro model shown *above*, and a down-scaled version called the Utility model, have proven to be reliable performers for a number of years. Both of these fences, and the new Vega Commercial model shown *below*, have a micro-adjust mechanism. With this feature you can lock the fence approximately where it belongs, then dial it to an exact position with a threaded knob. This feature also comes in handy when you need to "tweak" a precise cut.

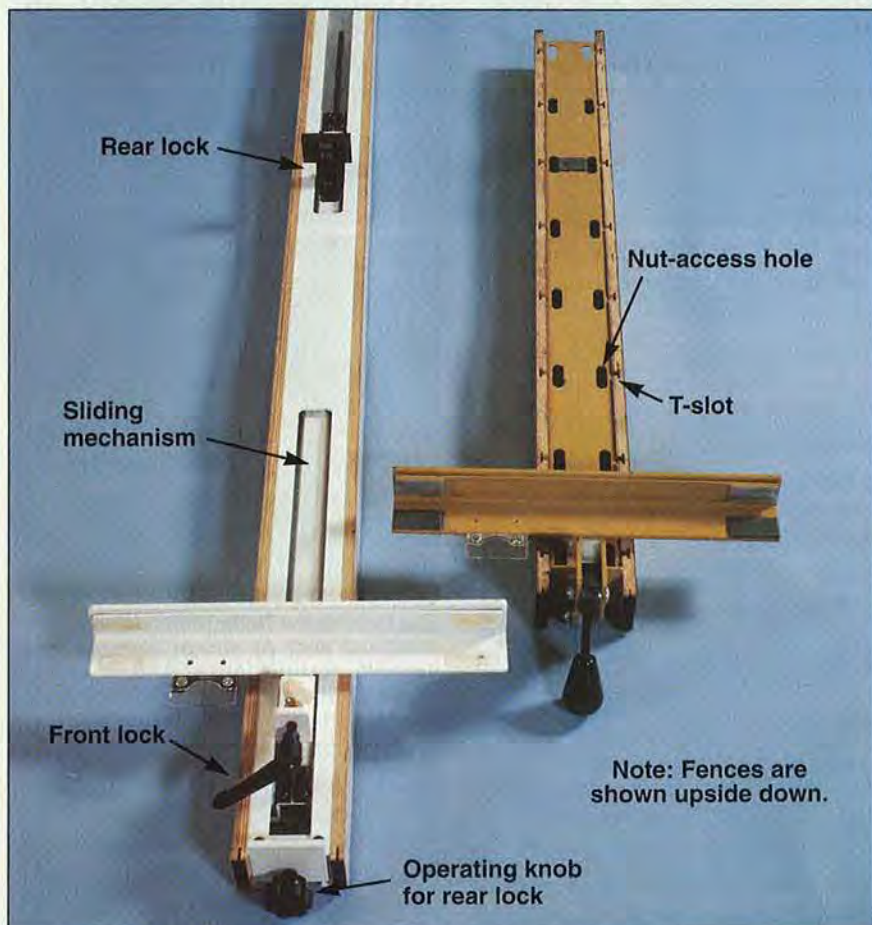

The Modulus SSF-100 (left) and Powermatic Accu-Fence look like Biesemeyer fences, but they feature significant modifications.



Micro-adjustment mechanisms, like this one on the underside of the Vega Commercial model, have threaded knobs that help you conveniently move the fence in controllable increments.

•**Sears Exact-I-Rip.** This unit is made almost entirely of beefy extruded aluminum components. The rails are light in weight, but stiff and straight. It has a micro-adjuster with the same benefits described for the Vega models.

The hardware and instructions packed with the Exact-I-Rip make it easy to mount to a Sears saw, but mounting it to another brand can be a challenge. This fence performs well, and we see it as a good upgrade for higher-end Craftsman tablesaws.

Continued

Rip Fences

Product choices *Continued*

•**Excalibur by Sommerville Design.** Unlike the other fences discussed so far, this fence “floats” along its rails because it rides on wheels both front and back. Finger pressure alone propels the fence left or right. Like the Modulus, the fence grips solidly in the rear as well as the front.

In our tests we found this system somewhat finicky. The rails flex more than any others in our test, so mounting them straight and parallel with each other proved to be a challenge (but it can be done if you have some patience). And, uneven spring pressure on the front wheels prevented the fence from repeatedly setting itself precisely parallel to the blade. We tried a second fence, but ran into the same problem.

•**Shop Fox.** This relatively new entry most resembles the Sommerville Design unit because it locks front and rear and moves on wheels. It rolls along a pair of angle irons as shown. These are considerably more rigid than the

Sommerville Design rails, but they still proved finicky during installation. We found the fit of some of the internal components, as well as the finish of the rails, needing some improvement.

•**Delta.** Like the Sears Exact-I-Rip, the Delta Unifence has a beefy extruded aluminum front rail and fence. And, similar to the Modulus SSF-100, the Delta fence slides forward and back as shown *below right*. But, unlike any of the other tested units, the Unifence can be repositioned for ripping thin stock as shown in the photos.

To complement the time-tested Unifence, Delta recently has come out with a down-scaled version called the Precision Saw Guide. Although it has a less-substantial extruded-aluminum front rail than the Unifence, it performed well in our battery of tests.

•**Paralok.** If you’ve ever used a drafting table with pulleys and cable for controlling the position of its horizontal straightedge, then

you already have a good idea of how the Paralok works. Although some woodworkers fear the complexity and doubt the durability of the cable system, our tests revealed otherwise. Installation was straightforward and took only about 45 minutes. The Paralok easily outperformed the other fences in our tests of repeatability of parallelism, parallelism over ripping range, and deflection.

•**Voss Technologies.** The Evolution I and its little brother, the Pro Rip, struck us as a cross between the Delta and Vega fences. Like the Deltas, both Voss models have U-channel front rails that capture the fence-locking mechanism on the inside of the channel. But, unlike the rigid aluminum Delta rail, the thinner steel rails of the Voss models had a tendency to flex. Like the Vegas, the Evolution I and Pro Rip have micro-adjust mechanisms.



The face on the Delta Unifence slides forward and back as shown above to meet various cutting tasks. And, it can be mounted in a high position (above) or low for cutting thin material (below).



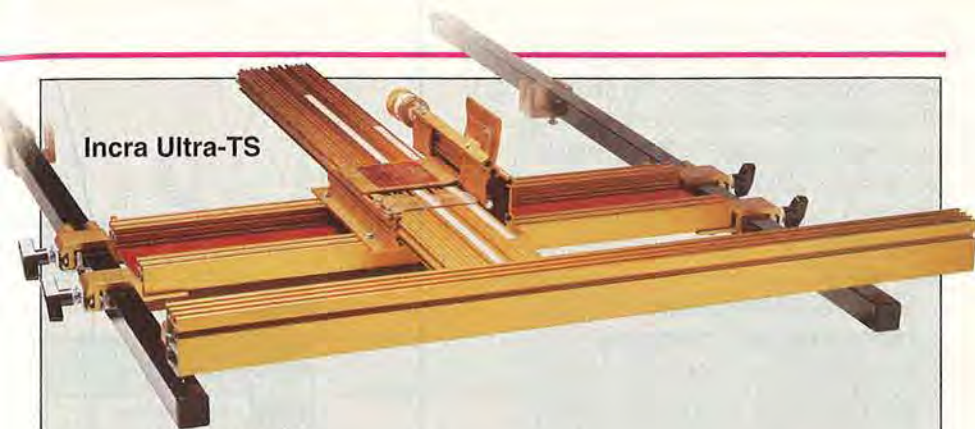

Incra Ultra-TS



The Vac-U-Fence excels at helping you rip thin strips, among other things.

Two products that are completely different

Most of us can get by just fine with one of the fences already mentioned. But if you have specialized needs, the Incra Ultra TS fence or Vac-U-Fence Saw Guide may be what you're looking for.

Like its famous cousin, the Incra Jig, the Ultra TS shown *top* uses plastic saw-tooth racks that automatically locate the fence at exact and repeatable positions (to within .004"). We found the fence ideal for small-scale work that demands incredible precision. But, it isn't rugged enough for ripping large boards or sheet goods. And, in our tests large workpieces caused it to deflect.

The Vac-U-Fence is actually an *attachment* for your existing fence. It uses suction provided by your shop vacuum to hold

workpieces of various thicknesses in contact with its face.

The accessory consists of a section of extruded aluminum with two chambers. Each chamber has different-sized holes so that you can flip the fence depending on the thickness of your workpieces.

It worked well in our tests by holding stock against its face without significant resistance to our feeding pressure. As shown *above*, we found it especially helpful for ripping thin strips. The suction ensured consistently thick strips during the cut, and prevented the strips from flying back at us at the completion of the cut. Its price: \$179 for clear anodized aluminum, or \$195 for colored. Not cheap.

Let's review the charted test results

We performed three key tests that measure *repeatability of parallelism, parallelism over ripping range, and deflection* for each of the tested fences. From these results we assigned performance ratings for the main chart.

•Repeatability of parallelism.

For this test, we set the fences for a 12" rip and adjusted them exactly parallel with the miter gauge slot (which was exactly parallel with the blade). Then, we subjected the fences to some typical shop use, reset them for a 12" rip, and with a dial indicator measured how well they maintained parallelism with the miter gauge slot. We did this several times, ripping various boards and sheet goods.

The Paralok was the champ. It consistently reset itself exactly parallel. The Delta Unifence was nearly as good, consistently resetting itself to within .001" of parallel. For complete results, see the chart on the *next page*.

•Parallelism over ripping range.

Here, again, we adjusted the fence parallel to the blade at a 12" ripping capacity. Then, we moved the fence away from the blade in 12" increments and measured the change in parallelism from the front to the rear of the fence. If the rear of the fence cocked itself toward the blade, this registered as a plus (+) reading on our dial indicator. Fences cocked away from the blade gave us a minus (-) reading.

In our tests, workpieces tended to lift off the tablesaw top anytime the fence was more than .005" out of parallel in the plus direction. At +.015 the stock burned badly and kickback became imminent. Dado-cut quality dropped when the fence was more than .005" out of parallel in either direction.

Rip Fences

• **Deflection.** As you feed a workpiece through a tablesaw blade, the workpiece exerts enough pressure on the fence to make the rear of the fence deflect away from the blade. To test this deflection under actual working conditions, we ripped a sheet of 3/4" plywood and measured the degree of deflection during the cut with a dial indicator. See the chart below right for complete results.

The Excalibur, Paralok, Sears Craftsman, two Modulus fences, and Woodstock International fences—all rear-locking units—earned “excellent” ratings in our main chart right.

The problem with excessive deflection is that when you let up on feed pressure, as inevitably happens unless you use a stock feeder, the fence tends to “spring” back toward the blade. Then, the position of the work-

piece shifts in relation to the blade, and telltale sawmarks (shallow arched notches) appear on the edge when you slow or stop the feed pressure. These marks, as well as chipping on dado cuts, showed up with any of the fences that deflected .005" or more.

Still “on the fence?” Here are our choices

The Paralok fence system stood clearly above the field for its dead-on precision. We were also impressed by the Powermatic Accu-Fence and Delta Unifence.

If you're looking for something a little less expensive, buy a home shop fence. Here, the Delta Precision Saw Guide was tops in our opinion, with the Biesemeyer home shop fence a close second. 🌲

PARALLELISM OVER RIPPING RANGE

BRAND	READING IN THOUSANDTHS OF AN INCH AT 12" RIPPING CAPACITY INCREMENTS		
	24"	36"	48"
Biesemeyer Commercial	-.004	-.008	+.010
Biesemeyer Home Shop	+.006	+.006	
Delta Unifence	-.001	-.002	-.005
Delta Precision Saw Guide	.000	.000	+.003
Excalibur by Sommerville Design	+.006	-.011	+.014
General T50 F42	-.004	-.013	-.017
General Home Shop	Not available for testing		
Incra Ultra-TS	-.003		
Jet Xacta Commercial	+.002	+.004	+.013
Jet Xacta Home Shop	+.006	+.008	
Modulus SSF-100	All Modulus fences tested on both Biesemeyer and General rails with results comparable to Biesemeyer and General.		
Modulus SF-100			
Modulus SF-10			
Paralok 27x6'	.000	.000	-.001
Powermatic Accu-Fence	-.003	-.006	-.010
Sears Craftsman Exact-I-Rip	-.005	-.008	
Vega Pro	-.011	-.008	+.005
Vega Utility	+.001		
Vega Commercial	-.001	-.008*	-.005
Voss Technology Evolution 1	+.001	-.008	+.005
Voss Technology Pro Rip	-.001	-.008	-.004
Woodstock Int'l Shop Fox	+.002	+.006	

* Reading taken at 30" rip capacity.

DEFLECTION

BRAND	DEFLECTION (IN INCHES)
Biesemeyer Commercial	.006 (6/1000")
Biesemeyer Home Shop	.006
Delta Unifence	.004(low)* .008(high)*
Delta Precision Saw Guide	.006(low)* .010(high)*
Excalibur by Sommerville Design	.0003
General T50 F42	.006
General Home Shop	.006
Incra Ultra-TS	.015
Jet Xacta Commercial	.014
Jet Xacta Home Shop	.009
Modulus SSF-100	.005
Modulus SF-100	.001
Modulus SF-10	.001
Paralok 27x6'	.0005
Powermatic Accu-Fence	.005
Sears Craftsman Exact-I-Rip	.001
Vega Pro	.005
Vega Utility	.008
Vega Commercial	.008
Voss Technology Evolution 1	.010
Voss Technology Pro Rip	.006
Woodstock Int'l Shop Fox	.005

* Readings taken with fence face in high and low positions.

Written by Bill Krier
Product testing: Dave Henderson
Photographs: Wm. Hopkins, John Hetherington

BRAND	MODEL	RIP CAPACITY (INCHES OF RIP WIDTH)	
		LEFT	RIGHT
BIESEMEYER	COMMERCIAL	12	50
	HOME SHOP	12	40
DELTA	UNIFENCE	8 1/4	52
	PRECISION SAW GUIDE	11	29
EXCALIBUR BY SOMMERVILLE DESIGN	INDUSTRIAL T-SLOT SAW FENCE	12	50
GENERAL	T50 F42	12	52
	HOME SHOP	12	40
INCRA	ULTRA-TS	16	26
JET	XACTA COMMERCIAL	12	50
	XACTA HOME SHOP	12	30
MODULUS	SSF-100 SLIDING SUPER FENCE-COMMERCIAL	12	50
	SF-100 STANDARD SUPER FENCE-COMMERCIAL	12	50
	SF-10 STANDARD SUPER FENCE-HOME SHOP	12	52
PARALOK	27x6'	16	50
POWERMATIC	ACCU-FENCE COMMERCIAL	12	50
	ACCU-FENCE HOME SHOP	12	50
SEARS CRAFTSMAN	EXACT-I-RIP	24	30
VEGA	PRO	10	50
	UTILITY	8	26
	COMMERCIAL	12	30
VOSS TECHNOLOGIES	EVOLUTION I	10	50
	PRO-RIP	10	50
WOODSTOCK INTERNATIONAL	SHOP FOX	8 1/2	25

NOTES:

- Most models are available in smaller capacities. Also, capacity can be shifted left or right for most models.
- (AE) Aluminum extrusion
(RS) Round steel
(SA) Steel angle
(SE) Steel edge
(SU) Steel U-channel
(TS) Tubular steel
- | | |
|---|-----------|
| E | Excellent |
| G | Good |
| F | Fair |
| P | Poor |

RIDING THE RAILS WITH TODAY'S RIP FENCES

MAXIMUM RIP CAPACITY AVAILABLE WITH OTHER VERSIONS (1)		FENCE (INCHES)		MATERIALS (2)		PERFORMANCE (3)												STANDARD ACCESSORIES (5)			AVAILABLE ACCESSORIES (5)			COUNTRY OF ASSEMBLY (5)			SELLING PRICE OF TESTED VERSION (7)			COMMENTS
LEFT	RIGHT	LENGTH	HEIGHT	RAIL	FENCE	REAR LOCK (YES, NO)	MICRO-ADJUSTMENT (YES, NO)	INSTRUCTION MANUAL	INSTALLATION EASE	ALIGNMENT EASE	EASE OF SLIDING FENCE LEFT OR RIGHT	EASE OF REMOVING FENCE	REPEATABILITY OF PARALLELISM (4)	PARALLELISM OVER RIPPING RANGE (4)	DEFLECTION (4)	T-SLOTS ON TOP OF FENCE (YES, NO)	STANDARD ACCESSORIES (5)			AVAILABLE ACCESSORIES (5)			COUNTRY OF ASSEMBLY (5)			SELLING PRICE OF TESTED VERSION (7)				
48	122	42	2 1/2	TS	TS	N	N	E	E	E	G	E	E	F	G	N	AF, LF, OF, SL, XT	U	\$350	The original T-square-style rip fence. It's still a rugged, precision tool with no major weak points.										
24	52	36	2	TS	TS	N	N	E	E	E	G	E	E	G	G	N	AF, SL, XT	U	260	Similar to Biesemeyer Commercial model, but with less-beefy components. Plenty stout for part-time woodworkers.										
8 3/4	96	43	1/2 or 3/4	AE	AE	N	N	E	G	E	G	G	E	E	G	N	SL	CO, ME, XT	U	360	A solid performer with a unique fence that changes from low to high in height, and slides forward and back.									
11	50	32	1/2 or 2 3/4	AE	AE	N	N	E	G	E	G	G	E	E	G	N	SL	XT	U	210	Lighter-duty version of the Unifence with similar advantages.									
LONGER RAILS MADE TO ORDER		45	2 1/2	AE/SE	AE	Y	N	G	F	F	E	E	F	F	E	Y	AF, FS, LF, SL, SP	C	325	Although fence glides along rails with ease, and locks solidly, we found installation and repeatability to be a problem.										
48	144	42	2 1/2	TS	TS	N	N	E	E	E	G	E	E	F	G	N	SL, XT	C	330	Nearly identical to Biesemeyer home shop model except for tape measure that includes a metric scale.										
24	52	36	2	TS	TS	N	N	NOT AVAILABLE FOR TESTING								N	SL, XT	C	295	Nearly identical to Biesemeyer home shop model except for tape measure that includes a metric scale.										
OTHER VERSIONS NOT AVAILABLE		36	2 1/2	TS	AE	N	Y	E	F	G	E	G	E	E	F	Y		U	360	Extremely accurate fence for small-scale work, but not rugged or versatile enough for everyday use in a typical shop.										
48	122	42	2 1/2	TS	TS	N	N	G	E	E	G	E	E	F	F	N	AF, LF, SL, XT	U	330	Modeled after the Biesemeyer Commercial, but it has thinner-gauge components and fence sides that wear more quickly.										
12	52	36	2	TS	TS	N	N	G	E	E	G	E	E	F	G	N	AF, SL, XT	U	260	Similar to Jet Xacta Commercial, but down-sized for the part-time woodworker.										
LONGER RAILS MADE TO ORDER		60	2 1/2	TS	TS/AE	Y	N	G	E	E	G	G	G	G*	G	Y		C	420/315*	A long fence that slides forward and back, along with rear-lock mechanism, make it ideal for use with sheet goods.										
		41	2 1/2	TS	AE	Y	N	G	E	E	G	G	G	G*	E	Y		C	350/240*	Similar to SSF-100 above, but has an average-length fence that does not slide forward and back.										
		41	2	TS	AE	Y	N	G	E	E	G	G	G	G*	E	Y		C	300/205*	Less-beefy version of the SF-100.										
16	78	36 1/2	3 1/2	SA	AE	Y	N	G	E	E	G	G	E	E	E	N		U	350	Our favorite fence because it never went more than .001" out of parallel at any position. Cable system wasn't problematic during installation or operation.										
48	122	42	2 1/2	TS	TS	N	N	G	E	E	G	E	E	G	G	N	SL, XT	U	340	Identical to the Biesemeyer Commercial model but has easily replaceable fence sides and three-position front lock.										
12	28	36 1/2	2	TS	TS	N	N	NOT AVAILABLE FOR TESTING								N	SL, XT	U	300	Down-sized version of Accu-Fence Commercial.										
OTHER VERSIONS NOT AVAILABLE		36 1/2	3	AE	AE	Y	Y	G	F	F	E	E	E	G	E	Y		C	270	Extruded aluminum components are light in weight, but stout, making this a good choice for Sears contractor-style saws.										
10	50	42 1/2	2 1/2	RS	AE	N	Y	G	E	F	G	E	E	G	G	Y	LG, SF, SL, SP	U	320	Vega's original fence is still one of the easiest to install. Its performance was about middle-of-the-pack.										
8	50	36 1/2	2 1/2	RS	AE	N	Y	G	E	F	G	E	E	G	G	Y	LG, SF, SL, SP	U	220	A smaller version of the Vega Pro intended for the occasional woodworker.										
12	50	41	2 1/2	TS	TS	N	Y	G	E	E	G	E	E	G	G	N	LG, SL	U	295	A new, all-steel model for heavy-duty use. Like other Vega models it has a micro-adjustment feature.										
0	60	42	2 3/4	SU	TS	N	Y	F	E	G	G	G	E	F	G	N	AK, CO, LF, OF, SL, TS, XT	U	299	A much-improved version of previous models. Easy to install. Has micro-adjustment mechanism and three-position front-locking handle.										
10	50	38	2	SU	TS	N	Y	F	E	G	G	G	G	F	G	N		U	259	Down-sized version of the above model.										
8 1/2	50	40	3 1/2	SA	AE	Y	Y	E	G	G	E	F	G	G	E	Y	SL	AK, TJ	T	275	Has locking mechanism similar to Paralok's, and roller system similar to Excalibur's, but rails were too rough for top performance.									

4. See article text for more explanation.

(*) Modulus fences tested on Biesemeyer commercial rails.

5. (AF) Auxiliary fence (OF) Offset fence
 (AK) Anti-kickback device (SF) Stock-feed system
 (CO) Cut-off fence (SL) Extension table support legs
 (FS) Flip-up work stops (SP) Stock pusher
 (LC) Laminate cutting guide (TJ) Tenoning jig
 (LF) Longer fence (TS) T-slots
 (ME) Miter-gauge extension (XT) Extension table

6. (C) Canada
 (T) Taiwan
 (U) United States

7. (*) Modulus prices given with/without Biesemeyer-type rails.

WHERE TO CALL FOR MORE INFORMATION:

Biesemeyer 800/782-1831 602/835-9300	Jet 800/274-6842 206/351-6000	Powermatic 800/248-0144 615/473-5551	Vega 217/963-2232
Delta 800/438-2486 412/963-2400	Modulus 800/633-8587 802/865-0569 (US only)	Sears Craftsman Call or visit your local store	Voss Technologies 719/635-2557
General 819/472-1161	Paralok 800/423-9611 503/281-8096	Excalibur by Somerville Design 800/357-4118 905/831-4755	Woodstock International 360/734-3482
Incra 972/243-7943			

COUNTRY BUFFET



Featured in the August 1996 issue of *WOOD*® magazine, our country-style table features a rock-solid top, turned (or mail-order available) legs, and a terrific paint job for a fine dining experience.



To match our popular country-style kitchen table at far left, we designed this handsome buffet and accompanying cupboard. Here we'll show you how to build the buffet. In the next issue, we'll present the matching cupboard. Keep in mind that these are terrific-looking stand-alone pieces that work equally well as a matching set.

Continued

COUNTRY BUFFET & CUPBOARD

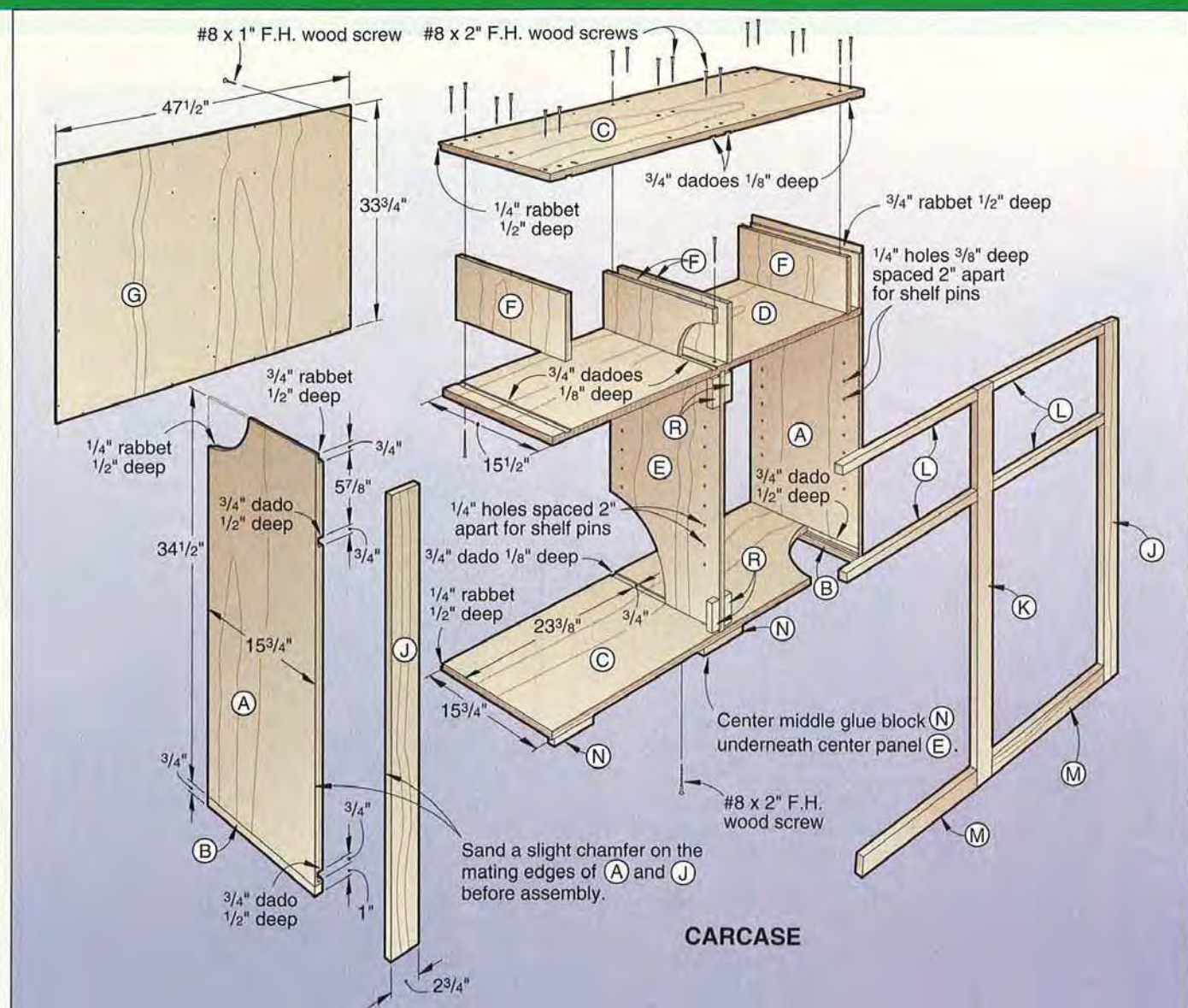

Build a carcass to form the basic substructure

1 Cut the carcass sides (A) and bottom banding strips (B) to the sizes listed in the Bill of Materials. Glue and clamp the maple bottom banding to the bottom edge of each plywood side panel where shown on the Carcase drawing. Later, sand the banding flush. (Since the bottom dado is so close to the bottom edge of each side panel, we found it helpful to add the bottom banding now, before cutting the bottom dado.)

2 Install a dado head in your table-saw. Test-cut scrap stock to verify that the width of cut is the exact

thickness of your plywood. Shim the blades if necessary. Then, cut 1/2"-deep dados and rabbets in the side panels (A) where dimensioned on the Carcase drawing.

3 Cut the top and bottom panels (C), drawer shelf (D), center panel (E), and kickers (F) to sizes.

4 Mark the dado locations on the upper and lower panels (C) and drawer shelf (D). Note that the upper panel (C) and shelf (D) have four dados where located on the Parts View drawing of the buffet on *pages 92 and 93*, while the lower panel (C) has just one dado where dimensioned on the Carcase drawing. Use the same

dado blade as used in Step 2. Now, lower it 1/8" and cut the dados in the panels and shelf.

5 Cut a 1/4" rabbet 1/2" deep along the back inside edge of the side panels (A) and upper and lower panels (C) where shown on the Carcase drawing.

6 For adding the solid maple top (S) to the carcass later, mark the centerpoint and slot locations on the bottom side of the upper panel (C) where shown on the pattern insert. Drill the holes and form the slots.

7 Glue and clamp the bottom panel (C) and drawer shelf (D) into their respective dados in the

Bill of Materials														
Part	Finished Size			Mati.	Qty.	Part	Finished Size			Mati.	Qty.			
	T	W	L				T	W	L					
CARCASE					DOORS									
A sides	3/4"	15 3/4"	34 1/2"	BP	2	T stiles	3/4"	3"	25 1/2"	M	4			
B bottom banding	3/4"	3/4"	15 3/4"	M	2	U upper rails	3/4"	3"	19 3/8"	M	2			
C panels	3/4"	15 3/4"	47 1/2"	BP	2	V lower rails	3/4"	4 1/2"	19 3/8"	M	2			
D drawer shelf	3/4"	15 1/2"	47 1/2"	BP	1	W panels	1/4"	14 1/4"	18 7/8"	BP	2			
E center panel	3/4"	15 1/2"	26 3/8"	BP	1	X vert. stops	1/4"	1/2"	18 5/8"	M	4			
F drawer kickers	3/4"	15 1/2"	6 1/8"	BP	4	Y horz. stops	1/4"	1/2"	13 3/8"	M	4			
G back	1/4"	47 1/2"	33 3/4"	BP	1	DRAWERS								
H shelves	3/4"	14 5/8"	22 3/4"	BP	2	Z fronts	3/4"	5 1/4"	19 3/8"	M	2			
I shelf banding	3/4"	3/4"	22 3/4"	M	2	AA sides	1/2"	5 1/4"	15 7/8"	M	4			
FACE FRAME AND TOP					CC backs					1/2"	4 3/4"	18 5/8"	M	2
J side stiles	3/4"	2 3/4"	35 1/4"	M	2	CC bottoms	1/4"	13 1/2"	18 7/8"	BP	2			
K center stile	3/4"	2 1/2"	35 1/4"	M	1	DD guides	3/32"	1 1/16"	14 7/8"	M	4			
L upper rails	3/4"	3/4"	20"	M	4	*Initially cut parts marked with an * oversized. Trim to finished size according to the instructions.								
M bottom rails	3/4"	1 3/4"	20"	M	2	Materials Key: BP—birch plywood, M—maple, EM—edge-joined maple.								
N glue blocks	3/4"	3/4"	6"	M	3	Supplies: #8x3/4", #8x1", #8x1 1/4", #8x2" flathead wood screws; #17x1" wire brads; 1 3/16x2 7/16" no-mortise brass hinges; 1 1/16x5/16" adjustable brass ball catches; 4-1 3/4"-diameter Shaker knobs; 1/4" brass shelf pins; paint, clear finish, Minwax Fast-drying polyurethane—gloss and satin finish, Krylon Sandable Primer—#1315 All-Purpose Primer White, Rust-Oleum American Accents Heritage Satin Finish Teal 7929.								
BEADING														
O* upper vert. bead	1/4"	3/4"	5 7/8"	M	4									
P* lower vert. bead	1/4"	3/4"	26 1/8"	M	4									
Q* horz. bead	1/4"	3/4"	20"	M	8									
R catch blocks	3/4"	1 1/8"	3"	M	4									
S* top	3/4"	17 1/2"	50"	EM	1									

sides (A). Take diagonal measurements to check for square, and make sure the front edges are flush. Slide the center panel (E) in place. Drill countersunk holes, and screw the panel in place.

8 Glue and screw the upper panel (C) to the top of the assembly with the drawer kickers (F) in place. Drill mounting holes through the upper panel and through the drawer shelf (D) to secure the mating pieces where shown on the Carcase drawing on the *opposite page* and the Front Section View on page 93.

9 Measure the rabbeted opening, and cut the back (G) to size from



Glue and clamp the stiles to the carcase first. Then, measure the distance between the stiles and add the rails.

CUTTING DIAGRAM

*Plane or resaw to thickness listed in the Bill of Materials.

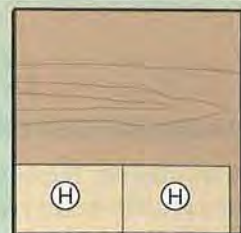

3/4 x 48 x 48" Birch plywood

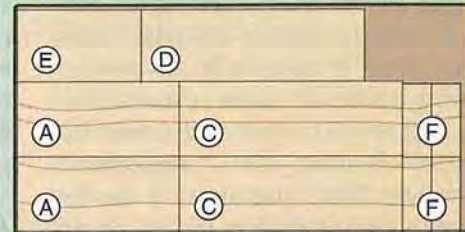

3/4 x 48 x 96" Birch plywood

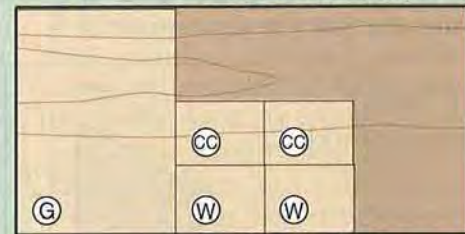

1/4 x 48 x 96" Birch plywood



3/4 x 9 1/4 x 96" Maple

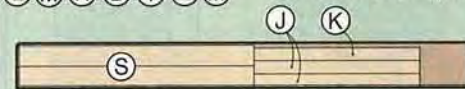

3/4 x 9 1/4 x 96" Maple

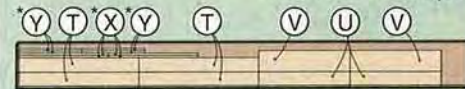

3/4 x 9 1/4 x 96" Maple

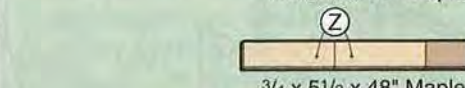

3/4 x 5 1/2 x 48" Maple



1/2 x 5 1/2 x 72" Maple

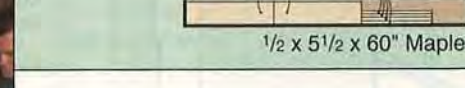

1/2 x 5 1/2 x 60" Maple

1/4" plywood. Set it aside for now, you'll screw it in place later.

10 Cut a pair of shelves (H) to size, and add the banding (I).

The face frame comes next

1 Cut the side stiles (J) and center stile (K) to the sizes listed in the Bill of Materials. Sand a chamfer on the mating edges of the sides (A) and side stiles (J) where shown on the Carcase drawing.

Continued

COUNTRY BUFFET & CUPBOARD

2 Dry-clamp (no glue) the side stiles (J) and center stile (K) to the cabinet, keeping the outside edges of the side stiles flush with the outside surfaces of the sides (A). You'll notice a $\frac{1}{4}$ " reveal along the front edges of the drawer kickers (F). This will cover up when installing the $\frac{1}{4}$ " decorative beading. Trim the stiles if necessary. Now, as shown in the photo on the previous page, glue and clamp the stiles to the carcass.

3 Cut the upper rails (L) and the bottom rails (M) to size. Check their fit between the stiles, and then glue and clamp them to the carcass. The top edges of the bottom rails should be flush with the bottom panel (C).
4 Cut the glue blocks (N), and glue them in place.

shown on the Exploded View drawing. The inside faces of the upper vertical beading (O) should be flush with the inside surfaces of the drawer kickers (F).

4 Cut the ball-catch blocks (R) to size, and glue them in place on the back side of the center stile (K) and surface of (E) where shown on the Carcase drawing.

5 Glue and clamp-up enough stock to form an oversized blank for the solid-maple top (S). Later, trim the top to finished size, and joint the front edge.

6 Rout partial round-overs along the front and ends (not the back) of the top (S), using the Buffet Top detail for reference.

7 Position the top (S) on the carcass, centered side-to-side and with the back edges flush. Clamp it in place. Using the holes and slots in the upper panel (C) as guides, mark the locations, and drill pilot holes into the bottom surface of the top. Secure the top to the carcass with flathead wood screws and flat washers. The slots allow for wood expansion.

Add the decorative beading

1 From the edge of $\frac{3}{4}$ "-thick maple, rip $\frac{1}{4}$ "-wide strips for the beading (O, P, Q) to size plus 2" in length.

2 Install a $\frac{1}{8}$ " round-over bit into your table-mounted router, and position the router-table fence flush with the edge of the pilot bearing. Then, rout the front edges of each strip, using a feather board for safety and to ensure consistent round-overs.

3 Sand a slight chamfer along the front edges of the face frame members that will receive the beading (O, P, Q). Miter-cut the beading strips to length, and glue and clamp them to the face frame where

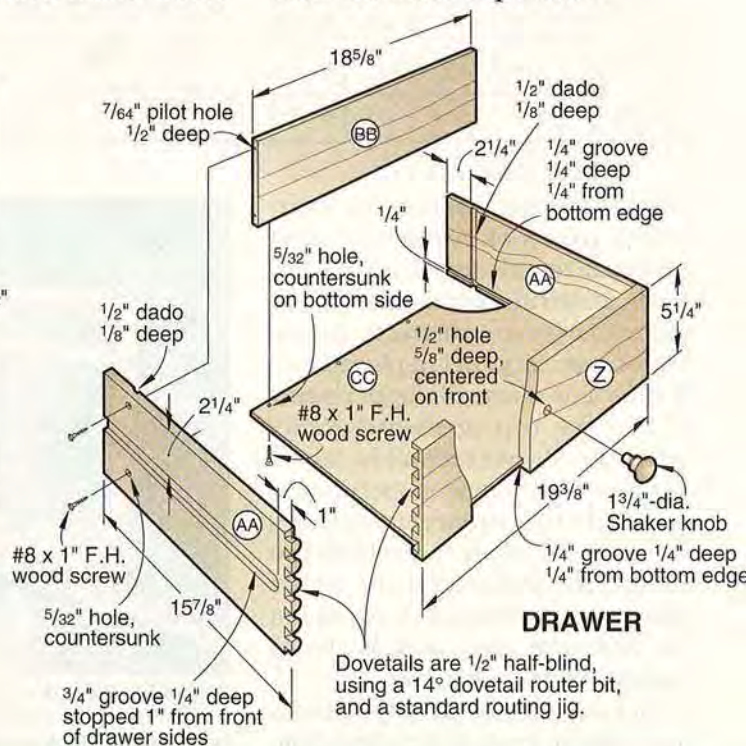
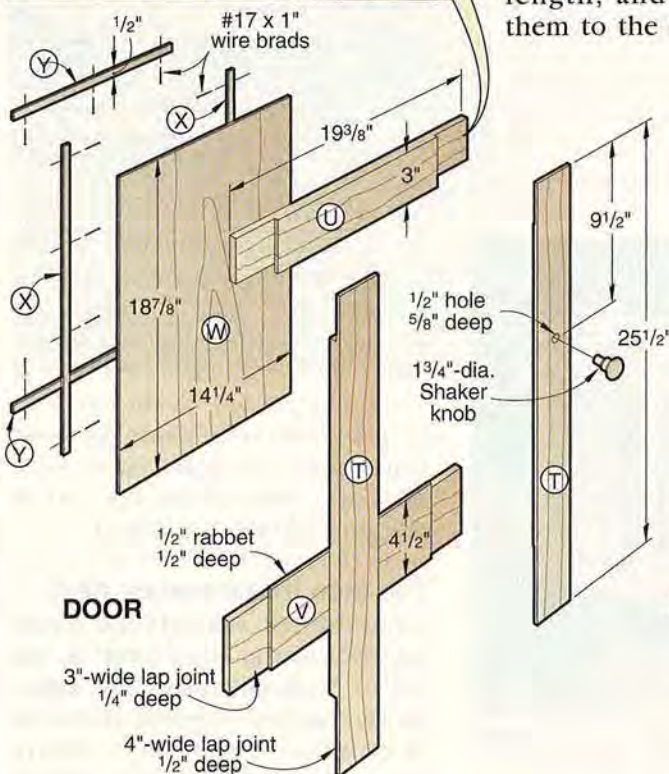
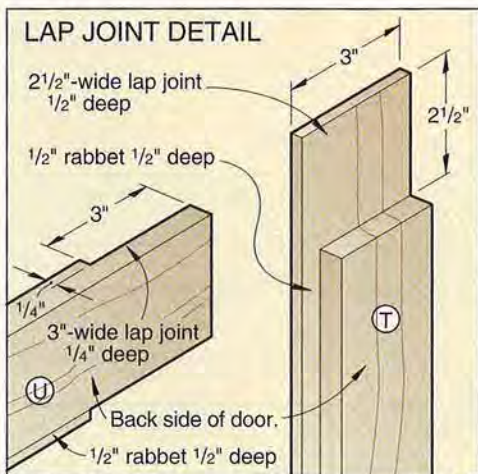

Machine a pair of frame and panel doors

1 Cut the door stiles (T), upper rails (U), and lower rails (V) to size, and lay out the parts to form the two doors.

2 Mark the front face and inside edge of each stile and rail. Then, cut $\frac{1}{2}$ " rabbets $\frac{1}{2}$ " deep along the inside back edge of each piece.

3 Cut mating lap joints across the ends of the stiles and rails to the sizes noted on the Door drawing and accompanying detail.

4 Glue and clamp the stiles and rails together for each door.

5 Mark the knob-hole centerpoint on each door. Measure the diameter of the tenon on your Shaker knob (they can vary in size), and drill the mounting hole.

6 Measure the rabbeted opening, and cut the $\frac{1}{4}$ " birch plywood panels (W) to size minus $\frac{1}{8}$ " in each direction.

7 Cut the stops (X, Y) to size. Drill pilot holes through the stops and temporarily install the stops and panels to check the fit. Remove them; you'll finish the panels before nailing them in place.

8 Install the doors using the no-mortise hinges. See the Exploded View drawing for hinge locations. Install the catches.

Construct a pair of drawers for handy storage

1 Cut the drawer fronts (Z) to size. Set aside a piece of stock the same thickness and width as the drawer fronts to use when setting up the router dovetail jig later.

2 Cut the drawer sides (AA), backs (BB), and bottoms (CC) to size. Set aside a piece of stock the same thickness and width as the sides and front for cutting and testing the dovetail joints.

3 Rout dovetails on the extra pieces cut in the previous steps. Verify the dovetail jig settings, and rout dovetails on the mating ends of the fronts (Z) and sides (AA).

See our dovetail jig article on *page 24* for more information on using these handy jigs.

4 Cut the dadoes and grooves in the drawer parts where dimensioned on the Drawer drawing. Then, drill a mounting hole in each drawer front for attaching the Shaker knobs later.

5 Rout a $\frac{3}{4}$ " stopped groove in the outside face of each drawer side for mating with the drawer guides (DD) later.

6 Glue and clamp each drawer together, measuring diagonally to check for square. Drill countersunk mounting holes through the drawer sides (AA) and into the ends of the back (BB) where shown on the Drawer drawing. Screw the back in place. Drill holes through the bottom (CC) and into the bottom edge of the back (BB), and secure it in place.

7 Cut the drawer guides (DD) to size, forming a $\frac{3}{8}$ " radius on the front end of each. Mark the centerpoints, and drill four countersunk holes through each.

8 To accurately locate the drawer guides (DD), cut the two 2"-wide spacers to the size shown on the Drawer Guide Template drawing on *page 93*. Now, using the photo *below* for reference, use the spacers to hold the guides in place



Use a pair of spacers to accurately position the guides. Then, drill mating holes in the kickers for attaching the guides.

while you drill the holes and drive the screws. Repeat for each drawer guide.

Finishing and final assembly

1 Cut the Shelf-Hole Template shown on the *WOOD PATTERNS®* insert in the center of the magazine. Drill the $\frac{1}{4}$ " holes where dimensioned. Then, use the template to drill the shelf-pin holes in the carcass.

2 Remove the top, doors, hinges, and catches. If not already removed, remove the panels from the doors. Sand everything to 220-grit. (We sanded the knobs by chucking them into a drill press.)

3 Apply a clear finish to the inside of the carcass and face frame (just to the sanded chamfer at the joint between the stile and side panel). Add finish to the top (both surfaces), the back, the door frames and stops, the drawers, and all the knobs. (We used Minwax Fast-Drying Gloss Polyurethane for the first coat, and sanded it with 220-grit sandpaper after it had dried. Over this, we applied two coats of satin polyurethane.) Do not get the finish into the knob holes or on the knob tenons.

4 Mask off the face frame stiles, and prime the carcass sides and the door panels (we used Krylon Sandable Primer, #1315 Primer White). Sand lightly with 320-grit sandpaper after the primer has dried. Paint the primed areas (we used Rust-Oleum American Accents Heritage Satin Finish Teal 7929). Let the paint dry, and remove the masking.

5 Glue the knobs into the doors and drawers. Screw the top and back in place. Install the panels in the doors and fasten the stop in place with #17×1" wire brads. Mount the hinges on the doors and reinstall the doors in the carcass. Reinstall the catches. Wax the drawer guides, and slide the drawers in place. ♣

WIRING YOUR

For a safe, smooth-running home woodworking shop, start by providing a suitable electrical supply.

Whether your woodworking shop is a corner of the garage, the basement, an old storage room, or a separate building out back, adequate and safe wiring is a necessity. So if you are considering a new shop or reworking the old, here are some helpful guidelines.

Note: Reference for this article was the current National Electrical Code. Before beginning any job, consult local codes at your city building inspector's office. And unless you have wiring experience, get the advice and services of a qualified electrician.

Is your present electrical service adequate?

The electricity your local energy company supplies is distributed throughout your residence from a service panel located in your basement or other utility area. If you live in a house 30 or more years old with the original wiring, you may have only a 60-amp service panel. With such little capacity, you probably won't be able to run more wires to power your shop.

Newer homes—and electrically updated remodeled ones—have 100- or even 200-amp service. With such large capacity service panels, there may be unused circuits available for your shop. Or, if all circuits appear to be in use, it's often possible to split an existing circuit or two to satisfy minimum requirements.

Depending on your needs (the number of large stationary power tools in your shop and the shop's distance from the main service

panel), you may want to add a subpanel to handle the load. For this kind of job, you should seek an electrician's advice.

How much electricity will it take to power your shop?

Although most portable power tools operate well with 15-amp circuits, you may want to build in some overload insurance with 20-amp circuits. The cost difference is negligible, and the higher capacity lowers your chances of popping a circuit breaker. Two such circuits (plus one for lighting) are adequate for most home shops, since all the tools won't be running at the same time.

If you suspect you'll need more than that, read the owner's manuals that came with your tools, or check the tools' labels to see what amperage they draw. You'll need this information, called load, to plan the size and number of circuits in your shop. For example, if one of your tools requires 20 amps, a 15-amp circuit won't do. (The chart below lists approxi-

mate amperage ratings for tools of different horsepower.) Also, if two large tools normally run at the same time, such as a tablesaw and jointer, they shouldn't be on the same branch circuit. And, if one of your tools requires 220 volts, it needs a separate circuit.

Always put lighting on a separate circuit

To avoid blackouts, don't combine circuits that serve power tools with those that provide electricity for lighting. One 15-amp circuit probably will handle the entire lighting job.

But just in case, here's how to calculate your lighting needs. Each square foot of shop space should get three watts of light. So if your shop measures 20×20', you have 400 square feet times three, or 1,200 watts. Divide 1,200 watts by 115 volts (actual performance) and you get 10.43 amps.

If you feel that you need more light, add up all the wattages (bulbs and fluorescents) you need or want. Then, divide that number by 115 volts to arrive at the number of amps drawn if all fixtures were on. Don't plan on exceeding 80 percent capacity of the circuit's rating, though. That is, for a 15-amp circuit you wouldn't want to exceed a 12-amp demand for your lighting.

Use wire large enough to do the job

Always use grounded wire, with one black insulated wire (the "hot" wire), one white insulated wire (the "neutral" wire), and a bare wire (the "ground"). For dry areas, run type NM wire. In damp locations, use type NMC.

The wire gauge (diameter—the smaller the number, the larger the

POWER TOOL AMPERAGE

HP	VOLTS	AMPS
¼	110	4.4-6.3
⅓	110	5-7.2
½	110	7-9.8
¾	110	11.5
1	110	13-15
1.5	110	16-19
2	110	19-23

For 220-volt motors, figure half the 110-volt amperage rating.)

SHOP

What you need to know to power up properly

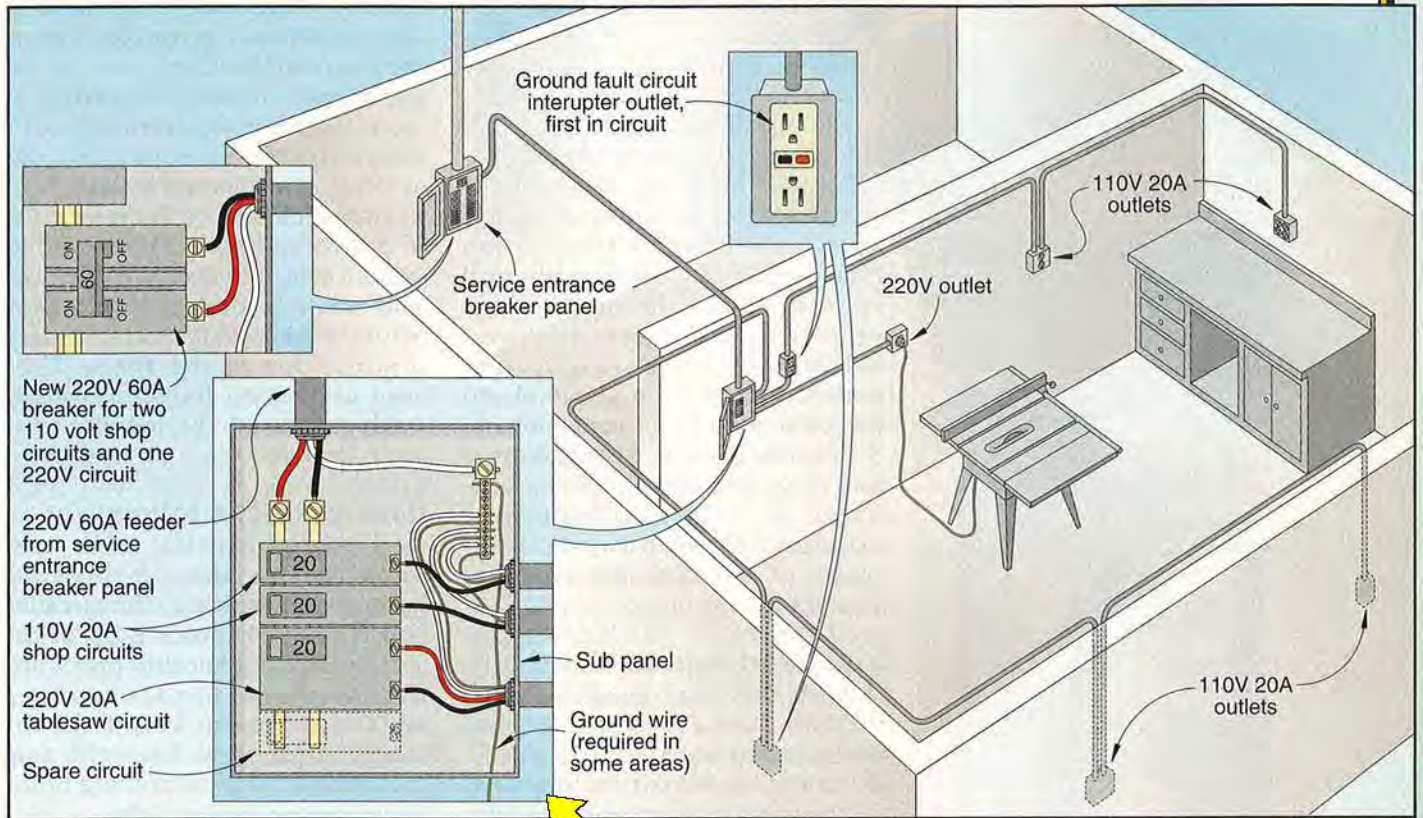

Typical wiring for the home woodworking shop

The 60-amp home workshop above features a lockable subpanel, two 20-amp circuits for portable power tools with a ground fault circuit interrupter (GFCI), and a separate 20-amp, 220V saw circuit. All wires are enclosed in conduit.

wire) you use will be determined by the distance from the service panel to the outlet as well as the circuit amperage. For example, a 15-amp circuit utilizing 14-gauge wire can safely reach 30 feet. By using 12-gauge wire, you could go to an outlet 47 feet away from the panel.

In many cities, all wiring must be enclosed in metal, thin-wall conduit. Check what your local building code requires. Usually, though, the rule of thumb is if your wiring isn't enclosed in a wall, it must run in conduit. Generally, you should install conduit anywhere wiring can be seen, felt, touched, inadvertently

reached, or could come in contact with moisture.

The conduit itself must be grounded. Metal outlet boxes and connectors make the grounding simpler. Don't use plastic boxes because they don't conduct electricity. Also, you'll need to reevaluate wire size with conduit, since it reduces amperage capacity as much as 20 percent.

Grounded outlets protect you and your tools

A GFCI, short for Ground Fault Circuit Interrupter, is a device installed either as a breaker in the service panel or as a receptacle in the outlet box that senses electri-

cal leakage in the ground circuit. If there's a leak, GFCIs shut off voltage instantly. They prevent electrocutions that happen when a person working with a portable power tool becomes the electricity's path to the ground. GFCIs also protect electrical motors from power surges.

Numerous building code sections specify the use of GFCIs—those pertaining to bathrooms, basements, kitchens, outdoor outlets, and more. Basically, if your shop is in a garage or unfinished basement, you must use GFCI protection. If you're not sure you should, use a GFCI anyway. It only costs a few dollars extra. 🌱

Written by Peter J. Stephano with Mike Gililand, PE, CSP Illustration: Kim Downing

Stupendous



Laminate the blanks

1 Cut two $\frac{3}{8} \times 2\frac{1}{2} \times 73$ " ash strips and one piece of mahogany $\frac{1}{4} \times 2\frac{1}{2} \times 73$ ". These three strips will be laminated into the blank for the two stilt legs (A).

2 Glue the strips together for the lamination, sandwiching the mahogany between the two ash layers. Clamp, using plywood strips to spread the pressure and protect the ash faces, as shown *below right*. Place waxed paper between the bottom plywood and the lamination to prevent sticking.

3 Construct another blank for the foot pegs (B). For this one, laminate a $\frac{1}{4} \times 4 \times 14$ " piece of mahogany between two $\frac{3}{8} \times 4 \times 14$ " pieces of ash. Glue and clamp as you did the leg blank.

You need legs to stand on

1 After the glue dries, unclamp the two blanks. Joint one edge of each lamination.

2 Rip the leg blank (the long one) to the maximum possible width, and trim the ends to 72". Rip the foot peg blank to $3\frac{1}{2}$ " wide, and cut two 6" lengths from it.

3 On one edge of the leg blank, lay out the foot peg holes where shown on the Leg drawing in the *WOOD PATTERNS*® insert. Center the holes on the edge, which places them in the middle of the mahogany strip. Draw another line across the edge 1" above the center of the uppermost hole.

4 Chuck a $\frac{1}{4}$ " drill bit in your drill press, and center the bit on the edge of the blank. Drill the five holes through the blank where marked. Countersink the holes on both edges for $\frac{1}{4}$ " flathead machine screws.

5 Place the edge of a foot peg blank against the marked edge of the leg blank. Align the top end of the foot peg blank with the line on the leg blank above the holes. Clamp it in place, and mark the top. Then using a hand drill with a $\frac{1}{4}$ " bit, mark the hole loca-

tions on the foot peg blank as shown *opposite page top*. Repeat for the other foot peg.

6 Set your tablesaw's rip fence 1" from the blade. Rip two legs from the blank, sawing so that an edge with countersunk holes rides against the fence each time.

7 Set up your table-mounted router with a $\frac{3}{8}$ " round-over bit, and position the table fence flush with the bit's pilot bearing. Clamp a stopblock to the fence, then rout a $2\frac{1}{2}$ "-long round-over along each corner on the lower end of each leg.

The footsteps follow

1 Determine the hole size required for the $\frac{1}{4}$ " threaded inserts you're using. (Ours called for $\frac{3}{8}$ " holes.) Chuck a bit of the proper size in your drill press, and drill the holes in each foot peg blank where marked. Drill the holes $\frac{3}{8}$ " deep to keep the foot peg screws from bottoming in the holes before they're tight.

2 Stick the two blanks together with double-faced tape, aligning the edges and ensuring that both tops point the same way. Lay out the foot peg profile on the top piece, referring to the Foot Peg drawing. Bandsaw the curve slightly outside the line, then sand down to it with a drum sander. Separate the parts.

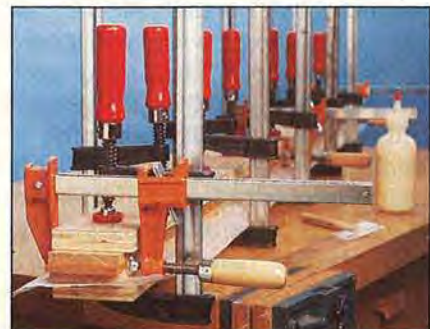

Strips of plywood help spread clamp pressure along the lamination and protect the surface from clamp marks. Put on crosswise clamps (the orange ones) first to keep the edges of the lamination aligned while tightening the clamps.

Stilts

Walking tall made easy

3 Open your compass to a 2" radius, and draw two 4"-diameter circles on $\frac{3}{4}$ " ash for the footsteps (C). Draw a line across the center of each circle perpendicular to the grain direction. Cut out the footsteps, and sand.

4 Using one of the footsteps as a pattern, draw two circles on $\frac{3}{4}$ " mahogany. From these, bandsaw four $1\frac{1}{2}$ "-wide arcs for the disc segments (D) at the leg tops. To lay out the segments' straight sides, draw a line across the center of the circle, then draw parallel lines $\frac{1}{2}$ " on each side of it.

5 Fit your table-mounted router with a 45° chamfer bit, and adjust it to cut a $\frac{1}{8}$ " chamfer. Chamfer the legs, foot pegs, footsteps, and disc segments where indicated on the Exploded View and Parts View drawings. Stop the chamfers 2" above the uppermost hole on the inside face of each leg. When routing the small parts, push them over the bit with a foam-faced jointer pushblock.

6 Sand a flat $\frac{1}{8}$ " deep (the depth of the chamfer) on the inside edge of each footstep (C), perpendicular to the line. Drill counterbores and screw holes where shown.

Put the parts together

1 Install threaded inserts in the foot pegs (B). Coat the holes with five-minute epoxy before driving in the inserts. To drive in an insert, put two nuts on a $\frac{1}{4}$ " bolt about 2" long, then screw the insert onto the bolt. Jam the first nut against the insert and the other against the first nut. Then, screw in the insert, using a ratchet and socket. Hold the foot peg in a vise to prevent splitting.

2 Assemble the stilt steps by attaching the footsteps (C) to the foot pegs (B). To do so, place the foot peg on your bench, back edge down. Center the footstep, flat side down, at the peg top. Guiding through the holes in the footstep, drill pilot holes in the



Mark the hole locations on the foot peg blanks by drilling through the holes in the leg blank.

foot peg. Fasten the footstep to the foot peg with #8x $1\frac{1}{2}$ " flathead wood screws and glue. Plug the counterbores, and sand flush.

3 Glue the disc segments (D) flush with the leg tops where shown. They glue to the solid ash faces, not the laminated edges.

4 Finish-sand all parts with sandpaper from 100- to 220-grit. Apply two coats of satin exterior polyurethane, sanding with fine abrasive between coats.

5 Install a 1" rubber tip on the bottom of each leg. Cut two $3\frac{3}{4}$ " circles from 4"-wide 3M nonskid tape, and apply one to each footstep. (We bought the tips and tape at a hardware store.)

6 Fasten the steps to the legs with $\frac{1}{4}$ -20x $1\frac{1}{2}$ " flathead brass machine screws. Start at the lowest setting, then move the steps up as your stilt-walker gains competence.

Project Design: Jan Hale Svec
Photographs: King Au
Illustrations: Roxanne LeMoine; Lorna Johnson

Part	Finished Size			Mati.	Qty.
	T	W	L		
A* legs	1"	1"	72"	LAM	2
B* foot pegs	1"	3 $\frac{1}{2}$ "	6"	LAM	2
C footsteps	$\frac{3}{4}$ "	4" dia.		A	2
D disc segments	$\frac{3}{4}$ "	1 $\frac{1}{2}$ "	3 $\frac{3}{8}$ "	M	4

*Make these parts oversized initially, then cut to finished size following the how-to instructions.

Materials Key: LAM—laminated ash and mahogany; A—ash; M—mahogany

Supplies: $\frac{1}{4}$ -20x $1\frac{1}{2}$ " flathead brass machine screws, $\frac{1}{4}$ -20 brass threaded inserts, #8x $1\frac{1}{2}$ " flathead wood screws, $\frac{3}{8}$ " wooden plugs, 1" rubber tips, 4"-wide nonskid tape, woodworker's glue, five-minute epoxy, satin polyurethane finish.

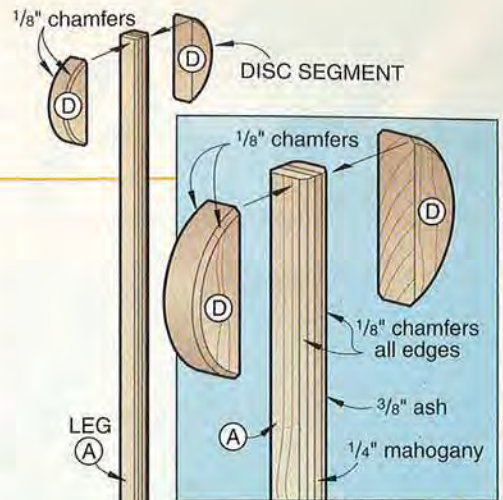

EXPLODED VIEW

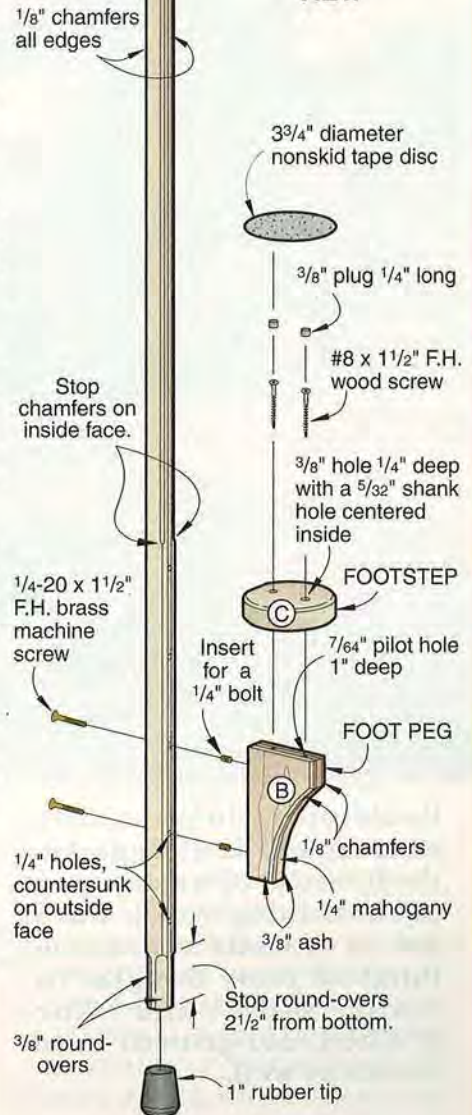

SEE THE WOOD PATTERNS®
INSERT FOR PARTS VIEW

SALVAGE



Removing metal is a time-consuming aspect of wood salvage. Jon Hoffman displays a sampling of what he has found on and in old timbers. *Inset.* Remarkably, this horseshoe imbedded in a beam was bypassed in its original sawing 100 years ago.

Reclaiming lumber from century-old buildings and the bottoms of waterways is backbreaking work. But it has its rewards in premium longleaf pine, Douglas fir, white pine, and fine-grained, old-growth hardwoods as well.

Jon Hoffman gets easily excited when he talks about reclaimed lumber. "That's the neat thing about this work. You can dig out

the nastiest-looking old beams, but once you saw into them, it's 'WOW! Look at that wood!' That's some satisfaction. And to think, for years most of these great old timbers went into local landfills."

With just three years' experience in the wood-reclamation business, Jon, 38, calls his Joliet, Illinois, company "the new kid on the block." Nevertheless, the J.M. Hoffman Lumber Company, "Purveyors of Premium Reclaimed Lumber," has earned a first-class

reputation in the Midwest as a source for old-growth longleaf (called "heart") pine, Douglas fir, and white pine, as well as hardwoods such as white and red oak, walnut, and chestnut.

Jon reclaims these and other species from 19th-century buildings slated for demolition: warehouses, stores, factories, granaries, barns, and even water storage tanks. His secondary source is sunken wood—whole logs of yellow ("red") birch, hemlock,

The New Way to Log Old-Growth Timber

cypress, heart pine, and white pine—recovered from the bottoms of lakes and inland waterways that before the turn of the century were the principal “highways” for travel to the sawmills.

Wood that you can hardly find anymore

The hard, yet attractive boards from the heartwood of longleaf pine that were used extensively for floors, staircases, and millwork in the most elegant Southern mansions have long been history. The Southern pine you see today comes from second- and third-growth plantation trees that rarely grow to 18" diameter before they're harvested.

The same is true for clear, straight-grained white pine that came from big trees in the vast stands that once covered the Upper Midwest. Now we make do with smaller, knottier stock.

And restricted logging in the old-growth Douglas fir forests of the Pacific Northwest has meant limited availability of this slow-grown wood that's as strong as it is goodlooking. These are the reasons Jon is in the wood-reclamation business.

“What I sell costs more than the lumber normally available,” says Jon. “First, there's time-consuming preparation work, such as cleaning and metal detection. Then there's the waste factor—at least 50 percent in remilling salvaged wood, with the cracks and everything. So right there the price of the raw material doubles. But there's nowhere else to buy it. It's the only available stock of that quality, and when it's gone, it's gone.”

How much would Jon's stock, made from salvaged timbers, cost

you? “In this business, there isn't a standard grading system,” he says. “We basically offer three grades in flooring: rustic, select plain-sawn, and quarter-sawn, all sold by the square foot, surface measure. They're appearance grades, and the boards are mostly 4/4 (1") thickness. Heart pine, for instance, our most popular wood,



Before salvaged wood is sawn, workers must go over it thoroughly with a metal detector to find nails, bolts, and other objects that would damage an expensive blade during remilling.

sells for \$5.60 a square foot in random widths of plain-sawn, the middle grade. Quarter-sawn stock would be in the \$7 range.”

But depending on the wood species—and where the building was located—Jon's prices can

Flooring products made from reclaimed timbers and beams of heart pine include, from left, rustic tongue-and-groove, select plainsawn, and select quartersawn.

vary. “I can't beat West Coast reclamation prices for Douglas fir because there is lots of it out there. On heart pine and white pine, I can be more competitive,” Jon notes.

Jon's company, although it does sell boards—and dressed timbers for beams—primarily markets heart pine remilled and profiled as tongue-and-groove flooring to high-end commercial and residential construction. Historic restorations have their place, too. “Last summer, we supplied Douglas fir flooring for a restoration project in St. Louis,” says Jon. “They specified that the new porch wood match the original, which was all clear, vertical-grain Douglas fir. We ran that job and also supplied them with antique white oak beams.”

Salvaging stock from the demolition forest

Most of Jon's timber comes from the demolition of buildings throughout the Midwest. For sunken river and lake logs, he contracts with divers from Wisconsin and Michigan to Alabama and Mississippi.

“At first, I geared up to do the demolition. I had a front-end loader, a truck with a flatbed trailer—the whole works,” recalls Jon. “My first demo job was a 40-60' radius water tank on the ground in Bettendorf, Iowa. It was all

Continued

SALVAGE

clear-heart, vertical grain redwood. I moved a lot of that stock to sign makers. But I soon learned that I couldn't do it all. So now I buy from demolition people or subcontract the work."

Jon's involvement with reclaiming wood normally begins with assessing a building to be razed. "I never buy a building sight unseen," he says. "I go to the job site and look it over. With a chainsaw, I'll cut out some wood from beams at different places—a random sampling. In barns, I look for signs of powder post beetles. In industrial buildings, it'll be water damage, or deep stains from chemicals or oil. Next, I check for tight-grained lumber, which indicates old-growth. Wood with wider growth rings is okay for resale as timbers, but not resawing and milling."

After he has given the building a good onceover, Jon can offer the owner or the demolition contractor a "ball park" price for what salvable wood might be in it. "But only when the wood is on the ground can I give them a final price because they lose a lot in the removal," he says. "Our people have to come in and sort it, band it, stack it, and have it ready to go on the truck. Demo contractors won't assume that cost. Five or so years ago, they were paying to have this stuff hauled to the landfill. Now, they think they're sitting on gold."

What type of wood does a typical industrial building yield? "Around here, first would be heart pine, then Douglas fir, although I just bid on a big six-story structure in Milwaukee that is all white pine. That's pretty unusual. And the wood in industrial buildings is good sized: 8x10", 8x12", 9x13", 10x12", 10x15", 15x20".

Barns and other farm buildings often hold surprises. "Recently, I talked with a guy out in western Illinois who has a 100-year-old



Above. Not many years ago, beams such as this 10x15" of old-growth heart pine from a razed building were wasted in local landfills.

Right. Jon mills heart pine and Douglas fir into heavy-duty, high-end flooring.

barn made from walnut," says Jon. "But back then they built from what was on hand. That's where you get buildings with walnut, chestnut, white pine, locust, and other unique hardwoods."

At this writing, Jon was preparing a bid to salvage the now closed Joliet Army Ammunition Depot. "The buildings I'm interested in are all Douglas fir," he says. "And there are between 2,000 and 3,000 white cedar telephone poles. Boat builders would be interested in that wood." ♣



Want to shop salvage?

For a price list of salvaged wood and other products, write to
J.M. Hoffman Lumber Company,
1919A Cherry Hill Rd.,
Joliet, IL 60433.
708/799-8877

Written by Peter J. Stephano
Photographs: John L. Schultz

Editor's note: As landfill fees go up and environmental awareness increases, wood salvage and reclamation businesses are springing up around the nation, offering unique and usually hard-to-find old-growth wood species, sometimes "as is." For a business near you, check the Yellow Pages under "demolition contractors" or "salvage." Your state's environmental quality agency or department of natural resources also should be able to steer you to a source.

Join Woodworker's Book Club...the Only Book Club exclusively for Woodworkers



#80362 \$18.95



#70319 \$19.99 hc.



#70320 \$18.99

when you take
3 BOOKS \$ 3.99
 for only **3** each
 plus postage & handling costs



#70229 \$18.99



Plus get a
FREE GIFT

There's
NO OBLIGATION
 to buy any more
 books, ever!



#70289 \$19.99



#80335 \$17.95



#70288 \$21.99



#80384 \$19.99



#70313 \$19.99 hc.

- As A Member You Get:**
- Big Discounts from 15-50%
 - Great selection of woodworking books
 - **FREE** Postage & Handling on all prepaid orders after this joining offer
 - 100% Satisfaction Guaranteed or Your Money Back!

2 FOR 1

#43150 \$35.98 hcs.
 Both Books count as One Selection



#70248 \$22.99 hc.

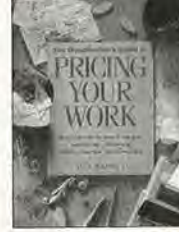

#70268 \$18.99



#70249 \$24.99 hc.



#70164 \$16.95 hc.

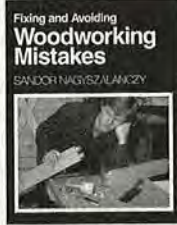

#80348 \$19.95



#80227 \$29.95 hc.



#80300 \$19.95



#70299 \$19.99

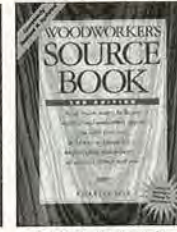

#70281 \$19.99 hc.

Plus Your
FREE GIFT!

Simple Steps to Accuracy in Woodworking



#80301 \$14.95



#70250 \$17.99

All books are softcover unless marked hc.

Mail your certificate to:
Woodworker's Book Club
 1507 Dana Avenue • Cincinnati, OH 45207
 1-800-937-0963

MasterCard/Visa orders call TOLL-FREE
1-800-937-0963
 9-5 Weekdays, Eastern Time

How The Club Works
 Fourteen times per year you'll receive the NEWS describing the Main Selection and up to 100 or more woodworking books. If you want the Main Selection, do nothing and it will be sent automatically. If you want a different book, or want nothing that month, you'll always have at least 10 days to decide and return your selection card. If late mail delivery should ever cause you to receive a book you don't want, you may return it at club expense.
 You are under NO OBLIGATION to buy any more books—you're just trying out the club for 6 months. After that, you may cancel at any time. Every time you buy a book from the NEWS, your membership will be renewed for 6 months from the purchase date.

Mail This Membership Certificate Today!

Yes! I want to join Woodworker's Book Club. Please rush my special New Member book selections: (Write the numbers of your 3 books in the boxes below.)

#	#	#
---	---	---

I have enclosed \$3.99 for each book ordered, plus \$5.61 postage and handling costs for an amazing low total of just \$17.58. I save up to \$60.00 (or more!)

Plus my FREE Gift #80360

Ohio residents add 7.2% tax. Canadians add 1.23 GST. Payment must accompany order.

Check enclosed (or) Charge my Visa MasterCard
 Acct # _____ Exp ____ / ____

I have read How the Club Works and I understand I have NO OBLIGATION to buy any more books, ever.

Signature _____
 (Required of Everyone)
 Name _____
 (Please Print)
 Address _____
 City _____

State/Prov _____ ZIP/PC _____
 Offer good for 90 days in U.S. and Canada, for new members only.

Remit in U.S. funds. One membership per household. All applications subject to approval. Please allow 3-4 weeks for processing. Club reserves the right to cancel any membership at any time.

Mail to: Woodworker's Book Club
 P.O. Box 12171 • Cincinnati, OH 45212-0171

WOOD® CLASSIFIED MART

For rates: 1-800/424-3090 Fax 312/464-0512

BUSINESS OPPORTUNITIES

KITCHEN SAVERS INSTITUTE. Learn all aspects to start and operate successful independent business. No franchise fees - Save Thousands! Cabinet refacing and restoration workshop includes: installation techniques, job pricing, suppliers, marketing and support services. 1-800/905-3980.

CATALOG/NEWSLETTER

WOODCARVING SUPPLY CATALOG/NEWSLETTER... Quality Tools, books, supplies, kits, classes. \$1.00 (refundable/order). Ivan Whillock Studio, 122 NE 1st Ave., Faribault, MN 55021.

FINISHING/RESTORATION

SPRAY-ON SUEDE. Free brochure with sample. New mini flocker. DonJer Products, Ilene Court, Bldg. 8W, Bellemead, NJ 08502. 1-800/336-6537.

HELP WANTED

EASY WORK! EXCELLENT PAY! Assemble Products at Home. Call Toll Free 1-800-467-5566 EXT. 11856.

HARDWOODS/LUMBER

HENDERSONVILLE HARDWOODS OF NC! 25 years lumber expertise. Family management team emphasizes top quality Appalachian Hardwoods/Softwoods, professional service, best prices. Small UPS specials, or large carrier orders. Send for our brochure: Hendersonville Hardwoods, PO Box 268, Hendersonville, NC 28793. For information call: 704/697-2929.

VERHOFF'S HARDWOODS, 1/4" S2S, poplar, cherry, oak, ash, 36" lengths by 12" widths, random, 75 sqft. SALE SPECIALS \$100.00 delivered: 3774 Erhart Road; Litchfield, OH 44253.

MUSIC/SUPPLIES

PLANS, KITS, SUPPLIES for musical instruments: harps, dulcimers, psalteries, banjos, guitars, more. Musicmaker's Kits, Dept. B97, PO Box 2117, Stillwater, MN 55082. 612/439-9120.

PLANS/KITS/PATTERNS

Hardboard **TEMPLATE router** cutting projects (most can also be cut with a **scroll/band saw**). Trial "Heart Picture Frame" **TEMPLATE**, instructions + catalogue send \$3.00 US (refundable) to: "Router Redi" 160 Main Street Box 92558, Brampton, Ontario, Canada L6W 4R1.

"WOODWORKING SOUTHWEST STYLE!" Professional designs include 36 plans for mailbox, wine rack, birdhouse, tables, doors and more. Detailed book, \$15.95 to: A-Pro Design Studio, PO Box 20578-W, Sedona, AZ 86341. <http://www.epcnet.com/apro>

TIRED OF HAPPY LITTLE SNOWMEN? Unique Scrollsaw designs based on original artwork. All skill levels. Send \$1.00 for information: Drew Phillips, PO Box 4384, Carson, CA 90749.

FURNITURE PLANS. Easy to follow. Easy to make. Computer Generated. Catalog \$3.00: Lake Superior Design, Box 751, Grand Marais, MN 55604-0751.

TOYS OF WOOD, Full-size Plans/Patterns cars, trucks, trains. Free info. Tarjany Designs, Box 8846 Dept. W, Calabasas, CA 91302.

PANEL SAW FOR PENNIES. Make straight precision cuts for less than \$25. Plans \$9.95: ACME Enterprises, PO Box 767485, Roswell, GA 30076.

FREE SCROLL SAW CATALOG. Describes over 70 patterns covering Holidays, Sports, Music, Farm, Careers, Outdoors. Call 1-800/233-3231 today. It's FREE!

UNIQUE KILN PLAN. For less than \$500 you can build a 1,000 to 4,000 board feet kiln. Tested for 7 years. For complete plan and how to instructions. Send \$29.95: Henagar Cabinet, 102 Gilbert Road, Henagar, AL 35978. 1-205/657-6250.

SHOWS/SPECIAL EVENTS

13th Annual Canadian Workshop Show Feb 28, & March 1-2, 1997 Toronto, Ontario. North America's Premier Workshop & Do-It-Yourself Event. Three exciting days of seminars and live demonstrations. Shop the latest in tools and take advantage of the Canadian dollar! For further information call 905/837-5095. Exhibitors Welcome.

TOOLS/EQUIPMENT

DRY YOUR OWN LUMBER. Ebac's user friendly dry kilns 200BF-40,000BF. Mix species in same load. Great 3-year warranty. Over 6000 systems worldwide. Call Today. 1-800/433-9011.

ATTENTION CLASSIFIED ADVERTISERS

Now you can reach over 1,100,000 responsive woodworkers and do-it-yourselfers in the **WOOD® Classified Mart** section.

The next closing date is **February 7, 1997** for the **May/June 1997** issue.

For rates and information call:
1-800/424-3090 • Fax: 312/464-0512
or write

WOOD® Classified Mart
500 North Michigan Avenue • Suite 2010
Chicago, IL 60611.

YESTERDAY'S TOOLS

DANCING-MASTER CALIPERS

Craftsmen made them just for kicks

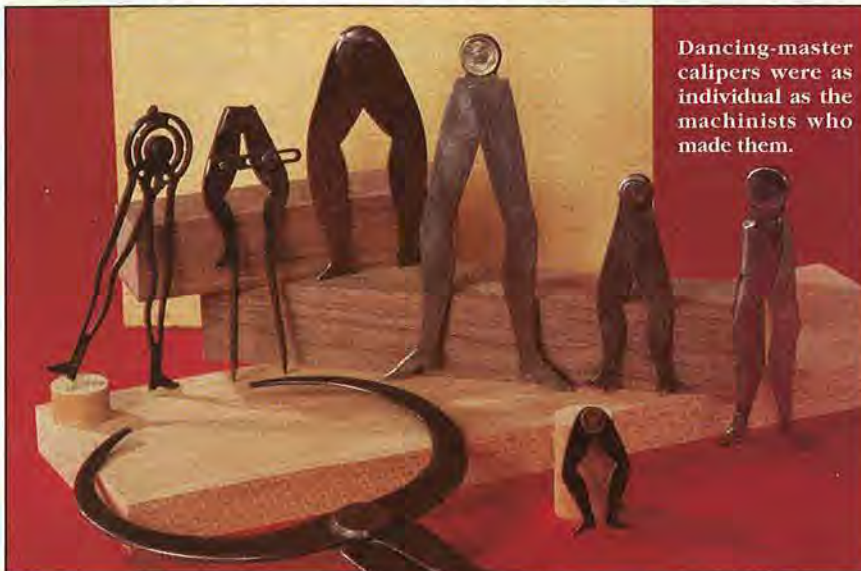

Dancing-master calipers were as individual as the machinists who made them.

Sometimes, having the right tool gives you a leg up on a particular job. But with calipers like the ones shown above, craftsmen of years gone by could have a leg up on every job.

Dancing-master calipers, as they were called, originally appeared in the late 1700s. Who first made the legs of a caliper anatomically correct (or nearly so, anyhow) isn't known. But, doing so certainly gave new meaning to the act of stepping off a measurement.

We may never know why machinists began making these unique calipers either, but tool collector John Gillis of Yucaipa, California, has some ideas. "Maybe machinists were just trying to express their artistic side," he suggests. "During the Victorian period [1837-1901], many wood-working machines and tools were elaborate in design—almost works of art. The [dancing-master] calipers of that period tend to be voluptuous," he says.

Yet many of these calipers pre-date the Victorian era and its emphasis on the beauty of tools

and machines. That makes John suspect that the craftsmen's motives may have been slightly raffish, that the calipers were an early-days equivalent of later pin-up posters and calendars.

You probably won't find any two calipers alike; they were all hand-made. "Some are masterpieces of technical workmanship, with elaborate hinges," John says, "while others are masterpieces of art, with lovely forms." The best of the calipers combine technical and artistic merit. "They are as varied as the machinists who made them," John says.

Nobody knows how many dancing-master calipers machinists turned out before the practice died out in the 1940s. Flea markets and tool auctions are the best places to find them today. You'll run across many selling for \$30-\$50. But, the price can soar for a great pair of legs. 🐾

Tools from the collection of John Gillis,
Yucaipa, California
Photograph: John Hetherington
Written by Larry Johnston

Start Your Own Business CUSTOM ENGRAVING

No Experience Necessary • No Artistic Ability Needed

- 400,000 RPM Engraving Tool
- Unlimited Potential
- Complete Stencils

HIGH SPEED ENGRAVING
SCM
SANDBLASTING



Professional Results

There is no experience necessary because SCM has developed a business opportunity that will have you producing professional engraving in a few short hours – just by tracing lines!

It's That Easy!

Engrave on...

• Glass • Wood • Metal • Stone • Marble • Eggs

To Find Out
Just How Easy It Is
Call Now For Details...

1-800-755-0261

W140 N5946 Lilly Road • Menomonee Falls, WI 53051



Circle No. 1990

“CHOOSE A JOB YOU LOVE, AND NEVER WORK ANOTHER DAY IN YOUR LIFE.”

-CONFUCIUS-



BEFORE



AFTER

“I've always wanted to be my own boss. Now I have that. Plus, I'm doing what I really like to do. It is very satisfying to restore a customer's cherished piece of furniture to its original beauty.”

Mark Boyer,
Furniture Medic, Michigan

Your investment starts at
\$14,900*

We have a future for you with America's leading furniture and wood restoration company servicing the residential and commercial markets.

(800) 877-9933

Fax: (404) 363-0554

<http://www.mobilefranchise.com>



FURNITURE MEDIC
“the prescription for damaged furniture.”

*See Prospectus for Details.

Circle No. 1520

WHY ARE WE PRACTICALLY “GIVING AWAY”



“405 WOODWORKING PATTERNS FOR ONLY 2¢ EACH?”

IF YOU LIKE TO CUT PATTERNS OUT OF WOOD, THIS IS THE SET FOR YOU! YOU'LL FIND A TREASURE HOUSE OF IDEAS INSIDE. 405 BEAUTIFUL WOODWORKING PATTERNS AND DESIGNS.



(By Frank K. Wood)

FC&A, a Peachtree City, Georgia, publisher, announced today that it is practically “giving away” an all-new set of “405 Woodworking Patterns.”

- Welcome signs for every occasion.
- Glider swing, adirondak table and chair.
- Gardening grandparents and bunny.
- Swinging scarecrow and a scarecrow on a fence.
- Giant rocking horse, carousel and sea horse tables.
- Potato bin chest and collapsible basket.
- Birdhouses and birdfeeders in different styles.
- Ye olde English carolers, Christmas yard ornaments.
- Whizzing whirligigs like the rowing fisherman, flying eagle, flamingo, mallard duck and swimming fish.

- Christmas mouse for your house, Christmas train in case of rain!
- Santas galore.
- Shelf sitter's see-saw collection.
- Kitty door stop and four seasons perpetual calendar.
- Comical clowns, napkin rings and shelf brackets.
- Holstein cow — with udders that shudder and swinging tail too!
- Southwestern cactus collection.
- Wooden toys for girls and boys.
- And much, much more!



Build all these wooden favorites. Illustrated plans include intricately detailed patterns and complete instructions. To order a set, just return this notice with your name and address and a check for \$7.99 plus \$2.00 shipping and handling, and we will send you “405 Woodworking Patterns.” Or, for only \$9.99 plus \$2.00 shipping and handling, you can get both the basic set and an extra 100 large patterns.

Plus, as a purchaser of our set of “405 Woodworking Patterns,” if pleased, about every two months you will also be eligible for a first look and free trial preview of all companion pattern sets printed in the years ahead.

Send your check along with your name and address to: **FC&A, Dept. AWZ-2, 103 Clover Green, Peachtree City, GA 30269.**

You get a no-time-limit guarantee of satisfaction or your money back.

You must cut out and return this notice with your order. Copies will not be accepted!

**IMPORTANT — FREE GIFT OFFER
EXPIRES FEBRUARY 27, 1997**

All orders mailed by February 27, 1997, will receive a free gift, “50 Special, Seasonal, Woodworking Patterns,” guaranteed. Order right away!

©FC&A 1997

TOOL CRIB

OF THE NORTH

"Serving Satisfied Woodworkers & Contractors Since 1945"



\$389.⁹⁵

#DW995KS-2
18 Volt, 1/2" Adjustable Clutch
Drill Driver / 5-3/8" Cordless Saw
Combo Pack



\$94.⁹⁵

#DW423K
5" Random Orbit Variable Speed
Palm Sander With Case

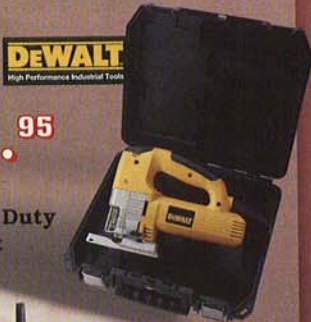

\$164.⁹⁵

#DW321K
V.S. Heavy Duty
Jig Saw Kit



\$219.⁹⁵

#DW621
2 HP Heavy Duty
VS Electronic
Plunge Router

\$199.⁹⁵

#DW682K
HD Plate Joiner Kit

DEWALT
High Performance Industrial Tools

OUR PRICES
PRICE GUARANTEE.
WON'T BE BEAT



1-800-358-3096

Or Fax Your Order 24 Hours A Day 1-800-343-4205

For a FREE Year
subscription to our
100 page Color
Catalog Call
1-800-582-6704

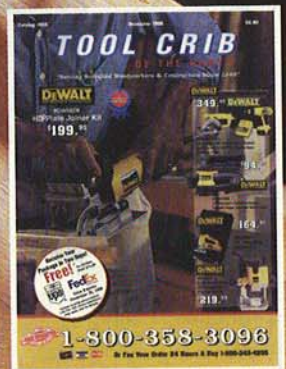

Economy Two DaySM service for \$5.00 More!
Ask for details.



Wood/ Feb. 1997

TOOL CRIB... an Easy Call to Make

Serving Satisfied Woodworkers & Contractors since 1948

Serving You For 49 Years! **FREE FREIGHT!**

TORMEK

2004-T Wet Grinding Machine \$389

PORTER-CABLE

The Woodworker's Choice

9444 PK Profile Sander Kit \$114

333 5" Quicksand dstds sander 79
332 5" Quicksand PSA sander 74
334 5" dustless PSA sander 79
97355 5" vs sander w/case 145
97366 6" vs sander w/case 149

DT250A 1"-2-1/2" Finish Nailer Kit \$249

FN250A16g 2-1/2" fnsh nail kt 209
FN200 16g 2" finish nailer kt 169
BN200 18g 2" finish nail kt 149
BN12518g 1-1/4" finish nail kt 99
NS10018g 1/4" crown spltr kt 99
NS150 18ga 1-1/2" finish spltr 169
FR350 2-3-1/2" clip hd nailer 329
FR350 2-3-1/2" full hd nailer 329

352VS 3x21 VS Belt Sander \$165

7810 tool triggered vacuum 269
556 plate jointer w/cs & fnce 139
360 3x24 sander with bag 214
362 4x24 sander with bag 219
985312v 3/8" vsr drl kt w 2 bt 159
9862 12v 3/8" dr kt w/2 bat 174

743K Left Hand 7-1/4" 15 Amp Saw w/Case \$129

347K RH 7-1/4" saw w/case 129
843 LH 7-1/4" saw w/brk 144
7310 laminate trimmer 104

90690K 1-1/2 HP Router w/Case \$159

97310 laminate trimmer kit 189
511 lock installation kit 159
9345 6" Saw Boss kit 134
9314 4-1/2" trim saw kit 169

7539 3-1/4 HP 5 Speed Plunge Router \$274

7116 24" Omni jig & video 309
691 1-1/2 hp D handle router 164
698 router-shaper table 144
697 router table w/router 234
7403 paint remover 179

9737PK Quick Change Tiger Saw Kit \$164

7499 New cut-out tool 69
97549 top handle vs jigsaw 144
693 1-1/2 hp plunge router 184

MK®

MK 660 3/4 HP Tile Saw \$599

Complete line in stock!

DELTA

22-540 12" Portable Planer & Extra Knives \$359

31-780 osc spindle sandr 194
36-250 10" sliding comp. 499
36-210 10" empd mtr saw 219
28-190 12" bandsaw w/stand 399
11-990 12" bench drill press 189
46-700 12" vs wood lathe 469
43-505 router/shaper 309
11-090 radial drill press w/std 399
14-650 mortising machine 249

37-070 6" VS Bench Jointer \$259

40-650 New 18" vs scroll saw 479
40-540 16" vs scroll saw 189
40-560 16" 2 speed scrl saw 174
31-460 4x36 belt/disc sander 134
23-700 wet/dry grinder 159
11-950 8" bench drill press 129
36-540 10" bench saw 179

PERFORMAX PRODUCTS, INC. 16-32 PLUS 16" - 32" Bench Drum Sander \$899

22-44 pro stationary sdr 1799
SuperMax-25 25" dr sdr 3199
SuperMax37x2 37" dr sdr 3899

BOSCH

1587VSK Top Handle Jig Saw w/Case \$159

1584VSK barrel jigsaw w/cs 159
1587VS New top hdlc jigsaw 139
1584VS barrel grip Clic jigsaw 139
3107DVS NEW 5" Dustless Random Orbital Sander \$99

3610K 14.4 volt drill w/2 batt 194
3107DVS 5" rdm sdr kit 119
3310K 12v T hndl w/2 bat 174
1276DVS 4x24 vs belt sdr 219
3270DVS 3x21vs sdr w/bag 164
1615EVS 3-1/4HP pl router 289
11224VSR 7/8" Bulldog hmr 224

1613EVS 2 HP, VS, Microfine Plunge Router \$209

B4050 in-line jigsaw 119
3296K 3-1/4" planer kit 179
B7000 center detail sander 74
B7001 vs corner detail sdr 94
3725DVS 5"vs H&L sander 144
3727DVS 6"vs H&L sander 149

freud

FT-2000E 3.25 HP VS Router \$179*

JS102 joining sys cs & fc 149*
TR-215 8-1/2" sl comp saw 299*
*Price After Mail-In Rebate

BIESEMEYER

78-900 50" Commercial w/12" Left \$329

78-934 52" homeshop fnc 279
78-931 40" homeshop fnc 259
78-930 28" homeshop fnc 249

HITACHI

C8FB2 8-1/2" Compound Mitre Saw \$499

C10FS New 10" slide cpnd 739
DN10DYK vs 9.6v R.A. drill 179
M12V 3-1/4 hp vs pl router 199

FUJI

Three Stage Turbine High Volume Low Pressure Sprayer \$599

MSXE-636-2 VS Triangular Oscillating Sander w/Case & Paper \$199

SENCO

SFN40 1-1/2 to 2-1/2" Finish Nailer \$389

SN325+ 6D-12D nailer 419
SFN-1Plus 1"-2" finish nlr 349
SN60 New full hd stick nlr 449
SLP-20 5/8"-1-5/8" br nil kit 279
SLS20 New finish spltr w/cs 249
SKS 1/4" crown finish spltr 279

Trakita

LS1011 10" Compound Mitre Saw \$429

6095DWE 9.6v vsr dr w/2 bat 124
5007NBK 7-1/4" saw w/cs 119
2708W 8-1/4" tbl saw w/br 309
2012 12" portable planer 499
3612C New 3hp pl router 269
LS121112" compd mitre sw 779
6311DWHE 12v hcap kt 2bt 219
9820-2 blade sharpener 174
N1900B 3-1/4" planer w/cs 134
3901 New plate joiner 199

OUR PRICES PRICE GUARANTEE WON'T BE BEAT

Panasonic

EY6100EQKWL 12 V, 3/8, 21 Position Clutch Kit w/2 Ironman Batteries \$194

Milwaukee

6527 Variable Speed Super Sawzall \$169

6491 10" miter s w/ct bl&bag 329
6494 New 10" comp. saw 319
6496-6 10" slide comp. saw 589
6497-6 10" slide saw w/bag 449
0408-6 12v vsr cds kit 174
0234-1 1/2" vsr 0-850 mgmm 134
0236-1 1/2" drill w/case 149
6368 7-1/4" saw w/cs & fc 139

DeWalt

DW936K 18 Volt Cordless Saw Kit \$249

DW935K-2 14.4 cds saw kit 239
DW625 3 HP VS Plunge Router \$279

DW621 2hp vs plunge router 219
DW670 laminate trimmer 99
DW673K laminate trimmer kit 189
DW705K NEW! 12" Compound Mitre Saw \$399

DW321K vs jigsaw with case 164
DW364 7-1/4" saw w/brake 164
DW361 7-1/4" saw w/brake 109
DW675K 3-1/8" planer w/case 164

DW682K Plate Joiner Kit \$199

DW106 3/8 4 amp keyless drill 74
DW250 0-4000 drywall drivr 89
DW254 0-2500 deck scrdwrvr 89
DW280Kall purp scrdwrvr kit 119

DW421K 5" Hook & Loop Dustless Random Sander w/Case \$74

DW423K5" vs rdm sander w/cs 94
DW443 6" RA H&L rdm sdr 144
DW411 1/4 sheet sand w/bag 59
DW431 3"x21" vs belt sander 189

DW995K 18 Volt 1/2" VSR Drill Kit \$229

DW991K-22 14.4v3/8" d/dr kt 219
DW991KS-214.4v drill/saw kt 349
DW972K-2 12v3/8vsr dr, 2 bt 184

SAME DAY SHIPPING

DELTA

36-900 3 HP Special Unisaw w/52" Unifence & Motor Cover \$1699*

36-820 3hp uni 52"unif & cv1599*
36-830 3hp unisaw 30"unif 1499*
36-8213hp unisaww/50" Bies1599*
36-8313hp unisaw w/30"Bies1499*
34-7785hp unisaw w/52"unif1849*

34-445 10" Contractor's Saw w/30" Unifence \$799*

36-460 10" cont saw 28"Bies729*
36-470 10" cont saw 40"Bies769*
36-480 10" cont saw 52"Bies799*
34-444 10" contractor's saw 649
34-555 sliding table attach 329
36-275 8-1/4" bnch table saw 269

28-280 14" 1 HP Bandsaw \$749*

28-275 14" 3/4hp bandsaw 589*
33-055 8-1/4" sawbuck w/legs 619
37-154 6" jointer/wstand 1224*
17-90016-1/2" floor drill press 429
34-080 10" mitre saw 219
23-710 sharpening center 174

37-350A 8" Jointer w/Stand \$1549*

43-355 1-1/2hp wood shaper 749*
43-379 3 hp hd 2 spd shapr 1699
31-730 6" belt/12" disc sandr 1349
33-890 12" radial arm saw 1599
33-990 10" radial arm saw 799

36-220 10" Compound Mitre Saw \$209

50-179 3/4 hp dust collector 399
36-906 52" Delta unifence 329
36-905 30" Delta unifence 249
32-100 plate jointer 279

22-675K 15" Planer \$1149*

37-190 6" jointer w/stand 499
36-850 1 phase stock feeder 499
32-325 13 spindle boring mach 999

31-280 Sanding Center With Stand \$799

36-755 10" cabinet saw 1149
36-751 10" cab w/30" unif 1299
36-752 10" cab w/50" unif 1399

50-901 3 HP, 230V Cyclone 2 Stage Dust Collector \$1849

50-902 5hp3hp cycln collectr 1949
50-903 5hp230v cycln colctr 2249
*Price After Mail-In Rebate

Hours: M - F 7:00 - 7:00 CST Sat. 8:00 - 4:00 CST

JDS COMPANY

AT2000 Air Filtration System \$259

8-12 air filtration system 489
18-34 accu miter ga. w/bar 149

Emqlo

AM78-HC4V 1-1/2 HP Vertical Twin Tank \$309

AM79-HC4V1-1/2hp vert comp 329
K15A8P 1.5hp wheelbarrow 619
K5HGA-8P 5hp Honda whlb 769
045 3/8"x50'Goodyear hose 20

JET

JTAS-10X 10" Jet Saw 3 HP w/50" XACTA Fence & Motor Cover \$1399

JTAS-10LX50-13hp lft tilt sw 1699
JWCS-10JF 2 hp sw, Jet fnc 959*
JPM-13 13" planr/moulder 779*
JWP-12 12" portable planer 364*
JWS-18H0 18" wood shapr 504*

JWTS-10JF 10" Saw w/Jet Fence \$579*

JWBS-14CS14" 1hp wd bdsww 559*
JWBS-140S14" 3/4hp w bsw 479*
JDP-17MF 17"tl 16 spd br 409*
JJ-6CSX 6" Long Bed Jointer \$469*

JJ-8CS 8" long bed jointer 1189
JWL-1236 8" vs wood lathe 569
JWP-15H0 15" 3hp w plnr 999*

DC-650 1 HP, 650 CFM Dust Collector \$214*

DC-1200 2hp1200cfm clecstr 429*
DC-1900 3hp1900 cfm collectr 619
JSG-66" belt/12" disc sandr 599
*Price After Mail-In Rebate

POWERMATIC ITM

1660760 66 Saw 3 HP w/50" Accu-Fence \$1999

1270100 #27shpr 3hp 1ph 2099
1610050 8"jntr 1.5 hp 1ph 1699
1791210 64 Artisan w/Accu 749
179121164 Artisanw/50"Accu 849
1791208 osc. spindle sdr 299
1791209 New 15" planer 1329
1791051 6"jointer w/stand 549
1791070 1-1/2 hp dust col 399

To Order or for Technical Support Call TOLL-FREE

1-800-358-3096

FedEx MOST PORTABLE TOOLS SHIPPED FED-EX \$5.00 MORE

FAX US YOUR ORDER! 1-800-343-4205

TOOL CRIB

OF THE NORTH

Wood Box 14040 • Grand Forks, ND • 58208-4040
Feb. 1997 Circle No. 8

*Any comparable National ad in this issue. We reserve the right to verify competitors price and stock. Limited to stock on hand.



•• FULL LINE DISTRIBUTOR •• FREE FREIGHT IN 48 CONTIGUOUS USA •• FACTORY AUTHORIZED SERVICE •• ERRORS AND PRICES SUBJECT TO CHANGE ••



Ryobi shrinks biscuit joiner to focus on detail work

Biscuit joinery used to be reserved for large scale projects, but that's no longer the case. With Ryobi's new DBJ 50 Detail Biscuit Joiner, you can use biscuits on projects such as face frames, picture frames, small boxes, and moldings. You also can edge-join pieces as thin as 1/4" and as narrow as 7/8" with the DBJ 50 and Ryobi's own miniature biscuits.

Ryobi offers its "Accu-Biscuits," in three sizes—R1 (7/32x3/8"), R2 (3/32x3/4"), and R3 (1/2x1"). These compare with the three standardized biscuits—#0 (9/16x1 7/8"), #10 (3/4x2 1/8"), and #20 (1 1/16x2 1/4").

Power comes from a 3.5-amp, direct-drive, 10,000 rpm motor mounted vertically over the blade. Ryobi uses this same basic design in its popular JM80K standardized biscuit joiner.

The DBJ 50 comes with a 1 1/2"-diameter, high-speed steel blade that cuts slots easily in both hard and softwoods. I found the length and depth of the slots was fine, but because of the aggressive set in the blade's teeth, which left a .120" kerf, the .100"-thick biscuits

fit loosely. Surprisingly, though, joint alignment and strength didn't appear to be compromised.

Ryobi made the DBJ 50's see-through fence both simple to use and accurate. Built from high-impact, tinted plastic, the 90° edge of the fence has a printed biscuit scale extending from both sides of the centerline. This makes aligning the joiner on your workpiece a snap.

A rib on the fence fits into a series of parallel grooves on the stationary base frame. Because of this, the fence adjusts in 1/16" increments, and it stays aligned perfectly parallel to the blade throughout the adjustment range.

Height-adjustment scales printed on both sides of the frame help you quickly reset the fence for different material thicknesses. To make 45° cuts, you remove the two knurled hold-down knobs, rotate the fence 180°, and then reinstall the knobs.

As an added feature, Ryobi offers biscuit-shaped hinges—chrome or brass in R3 size—for use on small boxes. By setting the fence to

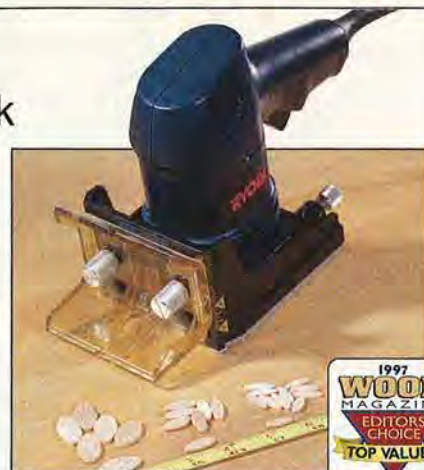

zero on the scale, the DBJ 50 will cut a perfectly sized hinge mortise in the edge of the stock.

The DBJ 50 comes with a convenient, 10'-long cord and carries a two-year warranty. Priced at \$69, it's a handy tool that will find a place in many workshops.

—Tested by Bob McFarlin

PRODUCT SCORECARD

Ryobi DBJ 50 Detail Biscuit Joiner

Performance	★ ★ ★ ★ ☆
Price	About \$69
Value	★ ★ ★ ★ ★

Ryobi America Corp., 5201 Pearman Dairy Road, Suite 1, Anderson, SC 29625-8950. Call 800/525-2579.

ScrollSander ends tedious hand sanding

Hand sanding intricate scrollsawn projects requires more patience than many woodworkers possess. However, a new product called the ScrollSander turns your scrollsaw into a power sander.

The ScrollSander consists of a strip of cloth-backed abrasive with polycarbonate plastic tips molded onto each end. The plastic ends come in versions for most pin-type and pinless blade holders, except those on RBI and Reliant scrollsaws.

ScrollSander strips currently come in 1/4" and 1/2" widths. The

1/2" strips were too wide to fit the throat opening on my Excaliber saw, but the 1/4" version worked fine. The manufacturer, Crawford-Adams Enterprises, plans to introduce another model that uses .055"-diameter abrasive cord. The cord should accommodate saws with narrow throat openings and permit sanding in any direction.

Each package contains one each of 120-, 180-, 220-, and 320-grit strips and they did an excellent job, even on brittle material and fine edges. With light pressure, they maintained a square edge and didn't break until I intentionally overloaded one. When one half became worn after roughly 30 minutes of continuous use, I flipped the strip end-for-end and used the other half.

For beginners who leave a lot of saw marks, the ScrollSander takes the tedium out of sanding. More advanced scrollsawyers may also find it handy to have on hand.

—Tested by Dave Henderson



Continued on page 80

PRODUCT SCORECARD

ScrollSander

Performance	★ ★ ★ ★ ☆
Price	\$6.95 (package of 4)
Value	★ ★ ★ ★ ☆

Crawford-Adams Enterprises, P.O. Box 1086, Verdi, NV 89439. Call 702/345-1660.

**NOW...
\$49**
With Over 300
FREE Pre-drawn
Symbols
Limited Time
Offer

Easiest to Use ^{CAD} or Your Money Back!

DrawingBoard LT - powerful 2D drawing software - is the tool to design all your basic projects. . .

- ⊗ Decks ⊗ Furniture
- ⊗ Landscaping
- ⊗ Home Office
- ⊗ New Construction ⊗ Remodeling
- ⊗ Over 300 FREE Symbols - for a limited time

DrawingBoard LT is yours for only \$49! .

DrawingBoard - professional 2D CAD - only \$145

Call **TOLL FREE** to get your **Software** and **FREE Symbols Library**, plus our **money-back guarantee!** Visit our web site for information & **FREE** sample software.

DrawingBoard



Drafting Software based on Award-Winning Ashlar Vellum

- ⊗ Patented Drafting Assistant
- ⊗ Smart Cursor Technology
- ⊗ Nurbs Spline Editing
- ⊗ Dimensions in Fractions
- ⊗ 30-Day Money Back Guarantee
- ⊗ FREE Demo @ www.mcesoft.com

Toll-Free 800-392-3046
<http://www.mcesoft.com>

Deck and Patio Owners:



OUTSMART THE WEATHER!

With a **SunSetter® Retractable Awning**, you can choose full sun, partial shade or total protection from rain or sun. Opens and closes effortlessly in 30 seconds!

Now get three times the use of your deck with the adjustable, affordable SunSetter Awning. It makes your deck or patio like an additional room on your house! Lets you enjoy your deck or patio rain or shine. Protects your family, guests and patio furniture from rain, harsh sun and harmful UV rays far better than a tippy patio umbrella. Adds to the beauty and value of your home. Expertly crafted in America for years of maintenance-free enjoyment.

- 100% waterproof fabric.
- Wide choice of available widths.
- Installs over any kind of siding.
- Retracts flat against the house.
- No need to take it down in winter.
- Superb quality - 5 year warranty.
- Interest-Free payment plans.
- No-Risk Free Trial.

SAVE WITH FACTORY-DIRECT PRICING!

Call today!

Write or call toll free for a **FREE VIDEO** and complete information
1-800-876-8060 Ext. 4223
24 hrs. a day, 7 days a week

SunSetter®

JIL Industries, Dept. WOD197
184 Charles Street, Malden MA 02148
FAX: 617-321-8650

JOINTECH®

ULTRA-PRECISION WOODWORKING SYSTEMS

IPM JOINERY SYSTEMS

This multi-patented system has been recognized by the experts as the *best* and the *easiest* to use to make dovetails and box joints plus, the best, all around patented dovetail incremental fence system you will ever own. Because IPM's accuracy is based upon a fine-threaded chrome lead screw, fine joinery is made easy and accurate cuts assured every time. Micro-adjustability even allows you to move the fence in thousandths of an inch increments.

CABINET MAKER'S SYSTEM

This one can do it all. All cabinet making operations can be accomplished with this ONE System. **JOINTECH'S CabinetMaker's Systems®** include all the Joinery System components plus our award-winning **SmartFence®**. You don't have to be a master craftsman to build beautiful cabinetry, furniture or even jewelry boxes. Our 48 templates enable you to easily make every type of dovetail and box joint. **SmartFence** accommodates any cutter in your shop allowing you to make raised panels, rails & stiles, tongue & groove, face frame construction, drawer design, edge-work and more. **JOINTECH'S CabinetMaker's System** is simply the best investment in quality and at a very affordable price.

New Woodworker's Notebook with Twelve Practical Projects plus jigs, fixtures and more.

Packed with over 300 photos and illustrations, this book is a must for any woodworker (including **Incra®** owners).

Incra is a registered trademark of Taylor Design Group, Inc.

CALL, WRITE OR FAX FOR A FREE BROCHURE & SPECIAL INTRODUCTORY OFFER DETAILS!

P.O. Box 790727 • San Antonio, Texas 78279
Toll Free: (800) 619-1288 • Fax: (210) 377-1282



Continued from page 78

Create moldings with these profile bits

Most homecenters carry just a few sizes and profiles of molding. These cost a lot, and rarely do the stores stock anything other than pine or oak. But with Eagle America's carbide-tipped Large Crown Molding Bits, you can rout your own molding from any wood you choose.

The cutting lengths of these bits measure 2 1/4", except for the cove molding bit, which measures 2 1/2". All come with 1/2" shanks. I found the bits well-balanced and properly sharpened—important considerations when you're spinning this much steel in a router.

To use these bits, you need a router table, a fence tall enough to support the workpiece, and a featherboard. And you should chuck them into nothing less than a 2 1/2-hp router running at



about 10,000-12,000 rpm. For additional safety, I ripped my workpieces 3/4" wider than the height of the cutter. This left a small strip at the top and bottom of the workpiece to follow the fence on the exit side of the router table.

Even with these precautions, you still need to remove wood in small increments, taking four to six passes to complete the cut. But if you're willing to take your time, these bits will help you make moldings to match the

wood in your projects at a reasonable cost. And you won't be forced to use moldings carried at retail outlets.

—Tested by Dave Henderson

PRODUCT SCORECARD

Large Crown Molding Bits

Performance	★ ★ ★ ★ ☆
Price	\$65.95 each ppd.
Value	★ ★ ★ ★ ☆

Eagle America, 510 Center St., P.O. Box 1099, Chardon, OH 44024. Call 800/872-2511.

NEW IMPROVED MODEL! Now with Electronic Brake that stops the chuck from spinning the moment you release the trigger. No waiting to drill the next hole, drive the next screw or change bits.

The 16.8v Cordless SUPER DRILL

Save Big! As part of a nationwide media campaign, the world's largest cordless drill manufacturer has authorized us to introduce their high-powered 16.8v super drill that an unheard of \$89⁹⁵. Plus, wait till you see the 2 FREE BONUSES you get!

More power! Longer running time! Higher torque! Now you can get a fully-loaded 16.8 VOLT cordless drill for about half of what our competition charges for a 14.4 volt drill.

Why settle for less? This really is BY FAR the

2 FREE BONUSES!

If you're among the first 1000 people who take advantage of this exclusive direct-to-you offer, you'll also receive a 300-Piece Drill Kit containing screw-driver bits, twist drill bits, brad point bits, carbide-tipped masonry bits, drywall anchors and case PLUS a 21-Piece Bonus Accessory Kit (a \$39.95 combined value) FREE! Call now.



best cordless drill value available today!

TRY IT RISK-FREE

Your 100% satisfaction is guaranteed. If this drill doesn't exceed your expectations, return it within 30 days for a no-questions-asked refund.

To order your 16.8v Cordless Drill/Driver Set with carry case, charger and battery, call toll-free, 1-800-925-2005 or send your check for just \$89.95 (\$8.95 S&H). Item No. 70-0W3. CA res add sales tax. No dealers.

Extra batteries are \$39.95 ea. (\$3.95 S&H). Item No. 75-0W3.

Upgrade to a One-Hour Fast Charger for just \$9.95. Item No. 20-0W3. 2 FREE Bonuses for the first 1000 orders. Call today.

"Your 100% Satisfaction is Guaranteed!"

0-900 RPM, variable speed, reversible switch.

Industrial motor delivers 200 in. lbs. of torque.

Heavy Duty 3/8" Jacobs® Keyless Chuck

6 Precision Clutch Settings



Superb power-to-weight ratio.

Ergonomic pistol grip

Powerful 16.8-volt Battery for 20% longer running time.

UL Listed

Perfectly balanced T-handle design stands on its own.

Yours For Just \$89⁹⁵

Visit our web site: <http://www.greattools.com>

Call Toll-FREE 1-800-925-2005 • Great Tools Direct! 587F Ventu Park Rd. - Dept. 801 Thousand Oaks, CA 91320



Water-based wood filler low on fumes, high on convenience

To meet stricter air quality standards, manufacturers have worked hard to develop solvent-free finishing products. The Darworth Company not only developed a water-based wood filler, but also came up with unique and handy packaging.

FI:X Wood Patch comes in a wide-mouthed tube that allows you to easily squeeze out just the right amount of filler where you need it. The large, screw-on cap seals tightly and serves as a base to stand the tube upright for storage—both features which help extend the filler's shelf life.

The rounded shape of the tube's other end works great for shaping and smoothing the filler. Unlike a putty knife, the pliable plastic allowed me to easily overfill the holes in the wood. By overfilling,

you avoid depressions caused when the filler dries and shrinks below the wood's surface.

FI:X worked well, even on vertical surfaces, adhering tightly to the edges of holes without sagging. It is odorless and dries slightly slower than most solvent-based fillers, but I found I still needed to work fairly quickly.

Sanding was a snap. It easily sanded flush and smooth without scratches and didn't load up the sandpaper, traits not found in some fillers. I drilled clean pilot holes in it and found it held screw threads well. It cleans up with water, but you need to catch it before it dries.

The lone drawback I found was in staining. Like most fillers, it failed to accept stain as readily as the surrounding wood. However,



I did achieve better results if I applied stain immediately after I sanded it.

FI:X's ease of application, odor-free formula, and handy packaging make it well worth trying.

—Tested by Dave Henderson

PRODUCT SCORECARD

FI:X Wood Patch

Performance ★ ★ ★ ★ ☆

Price \$3.49

Value ★ ★ ★ ★ ★

Darworth Company, 7405
Production Dr., Mentor, OH 44060.
Call 800/624-7767.

Continued on page 82

Look Familiar ?



Original design

Original products

Original manufacturer

EXCALIBUR
SOMMERVILLE
DESIGN

20 Years of quality, dependability and service

300 Pearl Street, Buffalo, New York, 14202
940 Brock Road., Pickering, Ontario, L1W 2A1

For your nearest factory authorized dealer

Call 1-800-357-4118.

Scroll Saw

30" Illustrated
Available in 19" and
30" throat capacity

Econ-Abrasives

WE MAKE ABRASIVE BELTS ANY SIZE, ANY GRIT!

Standard Abrasive Sheets

CABINET PAPER

	50/pk	100/pk
60D	\$16.70	\$30.00C
80D	15.60	27.80C
100 thru 150C	14.50	25.60C

FINISHING PAPER

80A	\$ 11.15	\$18.90C
100 thru 280A	10.00	16.70C

NO LOAD PAPER(white)

100 thru 400A	\$12.25	\$21.25C
---------------	---------	----------

"C" = 100 SHEETS

Velcro® Vacuum Discs

8 Hole pattern for Bosch sanders

Dia.	Grit	Price
5"	60	\$.48ea
5"	80	.46
5"	100 thru 320	.45

* Available in 5 hole pattern *

*Wide Belts*Rolls*Flap Wheels
*Pump Sleeves*PSA Discs
*Router & Wood Bits*Wood Glue

*MasterCard, VISA, C.O.D. or Check
*SATISFACTION GUARANTEED!!!
*CALL FOR FREE CATALOG
- TX & NV add appropriate sales tax
- Continental U. S. shipping add \$5.50

ABRASIVE BELTS

Belts are resin bond cloth with a bi-directional splice, specify grits.

1X30	\$.81 ea	3X24	\$.93 ea
1X42	.81 ea	3X27	.96 ea
1X44	.81 ea	4X21 3/4	1.06 ea
2 1/2X16	.85 ea	4X24	1.10 ea
3X18	.86 ea	4X36	1.35 ea
3X21	.90 ea	6X48	3.50 ea
3X23 3/4	.93 ea	6x89	6.24 ea

OTHER SIZES ON REQUEST

HEAVY DUTY SPRING CLAMPS

Clamps come w/PVC tips and grips.

Size	Price
4"	\$1.75 ea
6"	2.25
8"	3.50

JUMBO ROUTER PAD(24" x 36")

It will not allow small blocks of wood to slip out under router or sanding applications. ROUTER PAD ONLY \$8.95ea.

JUMBO BELT CLEANING STICK
ONLY \$8.80

Econ-Abrasives

P. O. Box W865021
Plano, TX 75086
(214)377-9779

TOLL-FREE ORDERING LINE (800)367-4101

STEVE WALL LUMBER CO.

Quality Hardwoods and Woodworking machinery For The Craftsman and Educational Institutions

Ash	4/4	Select	2.15
Basswood	4/4	Select	1.80
Birch	4/4	Select	2.25
Butternut	4/4	1C	2.00
Cherry	4/4	Select	3.40
Hickory - Pecan	4/4	Select	1.85
Mahogany (Genuine)	4/4	Select	3.40
Maple (Hard)	4/4	Select	2.40
Maple (Soft)	4/4	Select	1.80
Poplar	4/4	Select	1.55
Red Oak	4/4	Select	2.35
Walnut	4/4	Select	3.25
White Oak	4/4	Select	2.30
Cedar (Aromatic Red)	4/4	1C+Btr.	1.55
Cypress	4/4	Select	2.15
White Pine	4/4	F.G.	1.10
Yellow Pine	4/4	Clear	1.60

Above prices are for 100' quantities of kilndried rough lumber sold by the Bd. Ft. FOB Mayodan, NC. Call for quantity discounts. Other sizes and grades available.

UPS	\$ 71.00
Specials	\$ 61.00
	\$ 73.00
	\$ 63.00
	\$ 87.00
	\$ 65.00
	\$ 90.00
	\$ 75.00
	\$ 63.00
	\$ 58.00
	\$ 74.00
	\$ 89.00
	\$ 73.00
	\$ 60.00
	\$ 68.00
	\$ 49.00
	\$ 59.00

Above prices are 20 bd. ft bundles of clear kilndried lumber 3"-10" wide x 3'-7' long (Random widths & lengths) Surfaced 2 sides or rough. Delivered UPS prepaid in the Continental U.S.

LOG RUN SPECIALS

100 bd. ft. Bundle
4/4 Cherry \$120
4/4 Walnut \$140
Add \$20 for S2S
Motor Freight Only
FOB Mayodan

STEVE H. WALL LUMBER CO.

BOX 287
MAYODAN, N.C. 27027
910-427-0637
1-800-633-4062
FAX 910-427-7588

Send \$1.00 For Lumber Catalog

Circle No. 592

PRODUCTS THAT PERFORM



Continued from page 81

Save money on broken bandsaw blades

It's a fact of shop life—bandsaw blades often break before they dull. Rather than throw away a good blade, you may want to try repairing it at home with the Deluxe Blade Brazer. This kit includes a blade-holding jig, flux, flux brush, and silver solder.

To begin repairs, you place the broken blade ends under a flat bar on the jig. Tighten the two thumb screws to secure the blade ends. Then, bevel-grind the broken blade ends to approximately 45°.

Next, butt the blade ends tightly together on top of the jig and spread flux around the joint. Heat the blade with a propane torch, as shown below, and apply the silver solder. After the weld cools, clean it up on the grinder.

I found it easy to make strong welded joints with the Blade Brazer. The kit's instructions were clear and helpful.

According to the manufacturer, the flux and silver solder should last for 80 welds on 1/4" blades. So, this jig will pay for itself after just a few repairs.

—Tested by Dave Henderson

PRODUCT SCORECARD

Deluxe Blade Brazer

Performance	★ ★ ★ ★ ☆
Price	\$41.95 ppd.
Value	★ ★ ★ ★ ★

Wood Systems, Inc., P.O. Box 510744, New Berlin, WI 53151-0744. Call 800/321-0834.



Continued on page 90

CMT QUALITY THAT RUNS IN THE FAMILY

Nothing beats an original CMT for a quick, flawless performance. Whether it's our #1 rated router bit* or our award-winning dado blade**, if it's made in Italy, it's a CMT original.

The one that's prized for its durability and precision. Valued by serious woodworkers the world over. And only available through the manufacturer and selected, authorized dealers. #1 rated quality... bit or blade, it's a CMT family trait.

For more information on CMT USA, Inc. products, call or fax for a FREE 124-page, full color catalog.

CMT USA, Inc. 307-F Pomona Drive Greensboro, NC 27407 ■ Toll free 1-888-CMT-BITS ■ Free Fax 1-800-268-9778 ■ e-mail: cmtusa@aol.com

© CMT UTENSILI SRL - TM: CMT, THE CMT LOGO AND THE ORANGE COLOR APPLIED TO TOOL SURFACES ARE TRADEMARKS OF CMT UTENSILI SRL

* rated #1 by WOOD magazine, December 1994 - ** AMERICAN WOODWORKER's Editor's Choice for 1994

Woodworker's Marketplace

This section features advertisers offering products by mail. Additional information can be found in the Woodworker's Resource section. Please contact the advertiser directly or use the Circle No. to the right of each ad to request information through the Woodworker's Resource envelope.

 Print this article

VAN DYKE'S RESTORERS

Supplies for woodworkers and antique restorers!



- Ising glass
- Curved & bubble glass
- Roll top accessories
- Hoosier accessories
- Carvings & moldings
- Furniture components
- Over 1,000 Brass, Glass & Wooden Hardware items
- Much, Much More

Over 8,000 Items

Call or Write For Your **FREE** Catalog

1-800-843-3320
Dept. 60047 • PO Box 278
Woonsocket, SD 57385

Circle No. 2067

Put some Uncommon tools to work for you and achieve Uncommon results!

Our tools are uncommon, and unmatched, in quality, variety and value. Over 60 pages of woodworking tools provide you with the largest selection of router tables and accessories available in the U.S., as well as, many other unique and useful tools. More than a catalog, it's also a wealth of information that will enlighten and inform anyone who works with wood.



WOODHAVEN

Call Today!
800-344-6657

5323 W. Kimberly
Davenport, IA
52806-7126

Circle No. 1290

WOOD TOY

- ★ Patterns
- ★ Parts
- ★ Wheels
- ★ Many New Patterns to Choose from.
- ★ Executive toys



SEND \$1.00 FOR NEW CATALOG

toys and joys

Box 628 w Lynden, Wash. 98264

Circle No. 465

PLAN #24 - \$7.95



PLAN #25 - \$11.95



PLAN #26 \$7.50



"SIZZLER" MOTORCYCLE PLAN - 14" long Classic Soft-tailed construction. Detailed frame & engine, Spoked Wheels, turning Fork, & working Kick Stand. Choice of Engine Heads, Seats, & Fender designs. PLANS include stand.

MOTOR ROAD GRADER PLAN - a 25" long challenging, authentic looking model with lots of details from full, sub, & cradle frames, to the complete drive-line & engine assembly. Many operational parts include turning "toothed" circle Turret, unique steering with Ball Knuckles, operating Cab Doors, Levers, & hydraulic Scarflire "Ripper".

"FIGHTER JET" - 14" long - is mostly a cut-out & trace project, generally taking a weekend or so, and is designed simply but with the realism and details of a real modern day Fighter Jet. PLANS include stand.

For PLANS send U.S. check or U.S. money order in the above amount to:

GATTO PLAN SUPPLY
55 Dogwood Road
Hamburg, PA 19526

Circle No. 355

THE WOODTURNERS CATALOG



Features:
Woodfast Lathes
Vicmarc Mini Lathes
Artisan™ Pen and Project Kits
Henry Taylor Tools
McNaughton System
Dale Nish Workshops and much more....

Craft Supplies USA is the Number One source for the finest woodturning supplies, tools, and workshops with unsurpassed prices and service.

CALL TOLL FREE 1-800-551-8876 TO ORDER
a **FREE** 88-page color copy of The Woodturners Catalog

CRAFT SUPPLIES USA 1287 EAST 1120 SOUTH PROVO, UT 84606

Circle No. 830

All-In-One





Drum Sander ⁵⁹⁹⁵ + s/h
A Drum Sander Using Recycled Variable Size Containers™
SodaSander™ 1-800-422-5048

Circle No. 79

S. LaRose, Inc.
Makers of Instruments & Accessories



If you're building the outsides, we've got the insides! Call or write for our FREE clock parts catalog, #W2

S. LaRose, Inc.
P.O. Box 21208
3223 Yanceyville St.
Greensboro, NC 27420
(910) 621-1936

Circle No. 2375

Wood Moisture Meter

Professionals and hobbyists can choose from 8 different Mini-Ligno moisture meters:



Versatile Affordable Sturdy!
Over 100,000 units sold.

Also introducing **New Mini-Ligno XL**

For brochure contact:
Lignomat USA, Ltd. PO Box 30145
503/257-8957 800/227-2105 Portland, OR 97230

Circle No. 1250

Be a Furniture Restoration Specialist

Discover Minuteman

Complete Shop Concept
Duplicate Parts • Repair Frames • Veneer

Strip • Repair
Touch-Up • Fake Grain
Marbelize • Resilver • Refinish

Why Minuteman?

- Proven, Low-Risk, Cash Return
- Low Start-Up Costs; Expert Training
- Environmentally Friendly System
- Wholesale Supplies
- Handy Sample Kits Available
- Systems From \$1,500-\$11,000
- 28 Years Experience; 3,000+ Shops

No Experience Necessary
◆ Part-Time, Full-Time ◆
Ideal for Men & Women

FREE 2-Day Business Exploration Seminar

No Obligation to buy!
Register Now - Limited Seating!

Call For FREE Catalog

MINUTEMAN, INC.

Ste. 17, P.O. Box 8, Waterloo, WI 53594

1-800-733-1776

Circle No. 1661

DON'T BUY A NEW TABLE SAW

You don't need to invest in a new saw for precision cutting! Just add a VEGA Fence System and / or Mitre Gage. You will be amazed at the results. VEGA fences are the easiest to install & the nicest to use. All feature a precision Micro Adjust. Don't settle for just any Saw Fence! Insist on VEGA for quality design at affordable prices. **MADE IN THE USA**

VEGA
PRODUCTS
SANDERS
COPIERS
LATHES
FENCES
MOBILE
BASES&
MORE



**INSIST
ON THE BEST**

VEGA Decatur Illinois 800.222.8342

Circle No. 1281

Buckboard Bench Kit

(Real Springs)



Kit Includes:

Authentically designed steel springs that give a little, steel arms and backrails, complete hardware and full-size plans with detailed instructions. 42"Lx22"W, 18"H to Seat, 30"H to Back

Price: \$49⁰⁰ (Quantity discounts available)
Pre-cut & drilled oak: \$70⁰⁰ Additional

The Roubesh Company

PO Box 348A, Star City, IN 46985

800-847-4947

Visa, MC accepted. Price includes shipping UPS

Circle No. 1085

Supergrit® SANDPAPER

HOOK & LOOP



4 1/2"	8 Hole	\$10.00/50
5"	5 or 8 Hole	\$12.50/50
6"	6 Hole	\$17.50/50
5"	Solid "E"	\$15.00/50
6"	Solid "E"	\$18.00/50
12"	Solid "E"	\$12.00/6

BELTS—A.O. RESIN SHEETS—9" x 11", A.O.

1 x 30 \$.75	4 x 24 \$ 1.10	60D, 80D \$ 14/50
1 x 42 \$.75	4 x 36 \$ 1.40	120C, 150C \$ 23/100
3 x 21 \$.85	6 x 48 \$ 3.50	180A, 220A \$ 19/100
3 x 24 \$.90	6 x 89 \$ 6.20	ABRASIVE ROLLS

RED HILL CORP. FREE 28 PAGE CATALOG
P.O. BOX 4234 & Incredible close-out sheets.
GETTYSBURG, PA 17325 **800-822-4003**

Circle No. 1267

Scroll Saw Projects



The Hottest new patterns, techniques, tips and ideas!

Patrick Spielman's full-color, 16-page, bi-monthly newsletter. Order your 1-year subscription for only \$19.95 or a sample issue and book catalog for \$1.00.

Send to: Spielman Publishing Co.,
PO Box 867-W, Fish Creek, WI 54212-0867

Circle No. 1142

1-800-CAL-SECO ORDER ONLY

SK-28SP TILTING SPINDLE SHAPER

3HP, 1 or 3Ph, 1" or 3/4" spindle, overload protection, forward and reverse switch, 30° spindle tilt, 3 speeds, optional sliding tables and 3/4" spindle, 340 lbs.

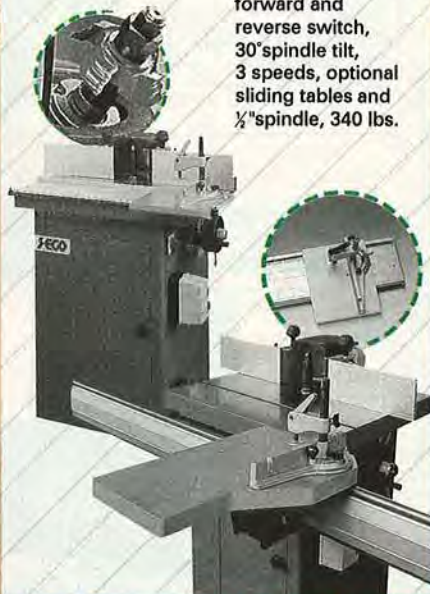

SECO INVESTMENTS COMPANY
WOODWORKING DIVISION

9865 S. Pioneer Blvd., Santa Fe Springs, CA 90670
Tel: (310) 949-7689 Fax: (310) 949-6588

Circle No. 91

CHOICE OF PROS

NOW AVAILABLE AT 40% LESS!

THE NEW WAGNER L609 MOISTURE METER...



L 4.5" x
W 2.75" x H 1.0"

- Pin-Free Narrow Sensor Deep Penetrating
- Features Wagner's Proven electromagnetic wave Technology
- Accuracy Verified by Independent Studies

Our Lowest Price Was: \$225

Now: **\$129**

WAGNER
ELECTRONICS

"The Choice of the Pros"

1-800-581-3301

326 Pine Grove Road
Rogue River, OR 97537
Phone: (541) 582-0541 Fax: (541) 582-4138

© 1997 Wagner Electronic Products, Inc. Circle No. 1285

How would you like a 5-second commute to work each day?



You could if your office were a few steps from your bedroom! Join the 25 million Americans who are now working out of their homes. Get the real scoop on the work-at-home market from two FREE cassettes recorded by George and Jeanie Douglass.

They started a \$50 million-a-year business from the basement of their home and they have already helped couples and individuals of all ages start their own home-based businesses. Find out how they can help you too!



For free cassette tapes and color literature Call

1-800-343-8014, ext. 4556

There is absolutely no obligation.

Or write:

CBSI, CBSI Plaza, Ste. 4556, Sheridan, IN 46069



Add that **Distinctive Look** to your woodworking projects. Quality handcrafted yet reasonably priced panels. Many finishes & designs. Do it-yourself materials & kits, too! Large colorful catalog \$5.00/catalog with 12 pc. sample pack \$19.95 ppd.

MasterCard/Visa accepted.

pierced tin
Country Accents® P.O. Box 437, Dept. WD-97, Montoursville, PA 17754 • Ph. 717-478-4127 • M-F 9-5

Circle No. 1910

OVER 1500 PATTERNS!
Huge variety of FULL SIZE woodcraft patterns!
Fun • Profitable • Fast Service • Guaranteed

Pick from our most popular pattern sets & order today!

EACH SET INCLUDES:
Full Size Patterns
Sketches
Step by Step Instructions
Painting & Finishing Info
Plus Tips & Techniques!

FREE S&H!

- 125 Pattern **BEGINNER'S BONANZA** plus "Shop Secrets".
- SHOW STOPPERS II-22** Craft Show best-seller!
- 25 fun & profitable "wind-action" **WHIRRIGS**.
- YARD CHARACTERS**- Amish, Dutch, bending lady, more!
- Eye-catching **DUTCH WINDMILL**- 5 feet tall.
- COUNTRY CRITTERS**- 100 Patterns, decorative projects.
- Over 30 **CHRISTMAS** decorations & centerpieces!
- 200 CREATIVE CUT** patterns for scroll, band or jigsaw.
- Decorative country **SHELF ASSORTMENT**, many options!
- COUNTRY CLASSICS**- 25 top-selling country designs.
- Create over 20 "Quick & Easy" **BIRD HOUSES**.
- 100 YARD ORNAMENTS**- Animals, bird, signs & more!

ACCENTS Dept. MA27 P.O. Box 7387 Gonic, NH 03839

Send \$8.00 per set or... **SAVE!** Pick 3 for \$19.50 • 6 for \$36.00 or All 12 for only \$60.00!!!

CALL TODAY! 24 Hr. Fax-Voice Mail (603) 332-4579 Mention offer # MA27

BIRD FEEDER BIRD HOUSE

FEEDER: 17" x 42" STAND PLAN \$14.95 ea. BIRD HOUSE: 16" x 40" PLANS \$24.95 ea. including S&H. Send check or money order or call **800-421-8221** Visa, Mastercard accepted

GOOSE POND MILL
P.O. Box 632, Occoquan, VA 22125-0632

Circle No. 365

Schlabaugh & Sons Woodworking
Clock Kits — Innovative Jigs
Weather Instruments & More!!

Innovative
Creative
Original
Must see catalog!!
1-800-346-9663

720 14th Street Kalona, IA 52247

Circle No. 2385

FREE BROCHURE!

THE WOODWORKING SHOWS
tools • supplies • education

VISIT THE SHOW NEAR YOU!

- Atlanta
- Buffalo
- Charlotte
- Chicago
- Columbus
- Dallas
- Detroit
- Harrisburg
- Indianapolis
- Kansas City
- Los Angeles
- Massachusetts
- New Hampshire
- No. California
- North Jersey
- St. Louis
- Tampa
- plus others!

Call 1-800/826-8257 for free brochure
Monday - Friday 8:30 am - 5 pm Pacific Time
e-mail: woodshow@earthlink.net

Circle No. 2390

FREE CATALOG
CALL 1-800-929-4321

Featuring our full line of quality woodworking machinery

JOINTERS
PLANERS
15" WIDE BELT SANDERS
TABLE SAWS

SUNHILL MACHINERY
The Best Machinery Value in America.
Sunhill Machinery, 500 Andover Park East, Seattle, WA 98188
U.S.: 1-800-929-4321 / CANADA: (604) 942-7196

ONE-MAN SAWMILL
Turns Your Timber Into **CASH!**

30-Day Free Trial!
Call NOW for FREE FACTS!
1-800-942-4406 ext. SW41
TIMBERKING, INC. Dept. SW41
1431 N. TOPPING, KANSAS CITY, MO 64120

Woodworking on the World Wide Web

Better Homes and Gardens®
WOOD ONLINE™

A WOODWORKING INFORMATION SERVICE FROM THE EDITORS OF WOOD® MAGAZINE

<http://woodmagazine.com>

Build this Adirondack furniture with our easy to follow instructions, material list, cutting diagram and FULL SIZE TEMPLATES

New Adirondack Tete-A-Tete \$12.95
Adirondack Chair 10.95
Adirondack Footstool 4.95
Add \$3.00 Shipping & Handling

Specialty Furniture Designs
797 W. Remus Road, Dept. W-41
Mt. Pleasant, MI 48858 • **1-800-892-4026**
Color Catalog \$3.00, free with order. Visa/MC/Disc MI add 6%

Circle No. 445

FREE SANDING BELTS
BUY A DOZEN GET A DOZEN FREE

FULL MONEY BACK GUARANTEE!!

1x30	17.95/doz	+ 12 free
1x42	18.50/doz	+ 12 free
3x18	18.95/doz	+ 12 free
3x21	19.95/doz	+ 12 free
3x24	21.95/doz	+ 12 free
4x21	24.95/doz	+ 12 free
4x24	25.95/doz	+ 12 free
4x36	35.95/doz	+ 12 free
6x48	40.95/1/2doz	+ 6 free
6x89	66.95/1/2doz	+ 6 free

Grits available: 36X to 320X
All belts A/O Resin Bond Cloth w/bi-directional butt splice

Full Line of 9x11 Sheets

ALSO AVAILABLE: Stroke Sanding Belts; Belt Cleaning Sticks; Inflatable Drums and Sleeves; Cloth/Paper Discs (PSA/Hook & Loop) Drum Sanding Rolls; Wide Cloth and Paper Belts or any size belt you may require and MUCH MUCH MORE!!

Call For Price Quotes • Orders • Free Catalog

Please add \$5.00 S & H / PA Residents add 6% Sales Tax

• Money Orders • Checks

1-800-428-2222
Mon. - Fri. 8am - 4:30pm EST

Fax: 1-610-378-4868
Anytime

INDUSTRIAL ABRASIVES CO. 642 N. 8th St. Dept. W P.O. Box 14955 Reading, PA 19612

THE SCROLLER'S SUPPLY STORE

Call 1-800-487-2623 Today!

r b industries
1801 Vine St., Harrisonville, MO 64701

GC01

Circle No. 1976

SQUARE DRIVE SCREWS



Simply the Best

Square Drive Beats Driver Slippage
Deep Thread for Super Grip
Hardened Steel for Superior Strength
Made in the US or Canada!

Send \$5 for Samples, Catalog, & \$5 Off Coupon

McFEELY'S SQUARE DRIVE SCREWS
PO Box 11169 • Dept WD
Lynchburg • VA • 24506-1169
Call Toll Free: 1-800-443-7937

Circle No. 2450

Quality MECHANISMS For Making WOODEN BARREL

- ✎ Pens
- ✎ Pencils
- ✎ Roller Balls
- ✎ Fountain Pens

plus other related items.

Wholesale/Retail

Call or Write:

BereaHardWoods Co.

6367 Eastland Rd. Brookpark, Ohio 44142
216-234-7949 Master Card/Visa

Circle No. 510, 1900

The Japan Woodworker's Catalog is . . .

loaded with the best tools you can get your hands on. In our catalog you will find a huge selection of Japanese saws, waterstones, chisels, planes, carving tools, cutlery and books. Send \$2.00 for our catalog and supplements during the next two years.

THE JAPAN WOODWORKER
1731 Clement E-32, Alameda, CA 94501
Phone 1-800-537-7820

Circle No. 190

Quality Kiln Drying

It's Easy and Affordable with a Nyle DH Kiln!

Call today for FREE FACTS on our L-Series dehumidification kilns.

EASY PAYMENTS AVAILABLE



Compact, easy to use kilns for 300 BF and up!

Free Booklet!

Filled with facts. To learn more about drying your own lumber, call for a FREE copy.

800-777-NYLE



PO Box 1107 Bangor ME 04402-1107

Circle No. 1260

WOODTURNING PROJECTS

SUPPLIES & ACCESSORIES



CARBA-TEC II MINI LATHE

- Variable Speed Motor
- Professional Quality

ONLY... \$269.95



Penn State Industries

2850 COMLY RD., PHILADELPHIA, PA 19154
1-800-377-7297

Circle No. 75

EVOLUTION

THE WORLD'S BEST SAW FENCE

- *Welded steel construction (not bolted up aluminum that can be knocked out of accuracy)
- *Machine ground front rail—super accurate
- *18" T-SECTION, the widest in the world
- *Exclusive DUAL SCALE READOUT 1/16" & 3X Magnified 1/64" scales. (Our "poor man's digital readout")
- *MICRO ADJUSTMENT for precise control
- *Super slick UHMW side panels, (wood glides thru the cut)
- *Hydral glides give you ball bearing easy movement left or right
- *Fits all brands, NO HOLES TO DRILL
- *Money back guarantee, lifetime guarantee



Credit Cards Accepted

800-386-5883



IWF Booth 2W27

3109 N. Cascade Ave. #204 Colo. Spgs., CO 80907 fax 719-635-2544

Circle No. 1263

The amazing walk-behind brush cutter! The DR® FIELD and BRUSH MOWER

CLEAR & MAINTAINS meadows, pastures, woodlots, wooded and rough non-lawn areas with ease. CUTS tall grass, weeds, brambles, tough brush and saplings up to 1" thick.

CHOPS/MULCHES most everything it cuts. Leaves NO TANGLE of brush to pick up like hand-held brushcutters and sicklebar mowers. Perfect for low-maintenance wildflower meadows, European-style woodlots, walking paths, or any area you only want to mow once a month or once a season!

- Self-Propelled
- Mows up to 1/2 acre per hour!
- Optional Electric-Starting
- 8 HP



MADE IN USA

Toll FREE (800) 626-8844

Please mail this coupon TODAY for complete FREE DETAILS of the DR® FIELD and BRUSH MOWER including prices, specifications of Manual- and ELECTRIC-STARTING Models, and "Off-Season" Savings now in effect. There is no obligation.

Name _____
Address _____
City _____ State _____ ZIP _____

To: COUNTRY HOME PRODUCTS®, Dept. 2079F
Meigs Road, P.O. Box 25, Vergennes, VT 05491

©1987 CHP, Inc.



The Kreg Jig

"Cuts project time in half, eliminates the need for an expensive arsenal of clamps and is simple to use. The Kreg Jig outperformed its competition by a wide margin. It's worth the investment."
Wood Magazine, Jan. 1995

DISCOVER THE POCKET HOLE ADVANTAGE



THE POCKET HOLE PROFESSIONAL

Discover the pocket hole secret for yourself. 30 day trial. Order today! Free catalog!

800-447-8638

Circle No. 877

Classic Heirloom Cradle

Two Cradle Plans
One for Babies
One for Dolls

You can easily build this classic cradle which will become a cherished family heirloom to pass from generation to generation. Two sizes available... Baby or Doll.



Full Size Plans

Baby size Plan (21 x 35) \$14.95 ppd.
Doll size Plan (10 x 18) \$8.95 ppd.

Spindles available in Oak or Maple. See our catalog which is sent free with your order.

M/C VISA orders call toll-free 1-800-292-8296

ARMOR Box 445 A, East Northport, NY 11731

Circle No. 315

For All Your Woodcarving & Sign Carving Needs

Terrco provides a full line of machine carving and sign carving equipment. Beginning models are the T-110 single spindle bench carver and our CM614 single spindle sign carver.

Intermediate models include the K-Star, a two-spindle heavy duty bench model, and the Northstar, a heavy duty floor model available in one to eight spindles.

Our advanced model is our Master Carver series, which is an extremely heavy duty floor model with from eight to forty spindles.

Write or call for more information.

Terrco, Inc.

222 1st Ave. NW
Watertown, SD 57201
USA
(605) 882-3888
Fax (605) 882-0778



Model T-110 Dupli-Carver



Model CM614 Sign Carver



Multi-Spindle Carving Machine

Circle No. 2150



TURN PENS IN 2 MINUTES!
The WoodWrite Microlathe — a revolution in pen and pencil turning. Call, write or fax for details & prices.

2121 Abell Lane, #44
Sparks, MD 21152 USA
Phone: 410-771-4444
Fax: 410-771-4879
Toll Free: 1-888-WoodWrite

WoodWrite Ltd

Circle No. 2098

CRAFT PATTERNS™ 70% OFF SALE!

Limited Time Offer **ALL FOUR FULL-SIZE PLANS**
REG. PRICE \$31.80

NOW ONLY **\$9.95** PLUS \$3.75 S & H



1-800-747-1429
24-HOUR ORDER LINE

CATALOG \$4.00 OR FREE WITH ORDER

CRAFT — DEPT. WM
PATTERNS, 3545 STERN AVE., ST. CHARLES, IL 60174

Circle No. 328

Oscillating Spindle Sanders
for discriminating woodworkers who demand the best

FREE Color Catalog
1-800-971-5050



CLAYTON™
MADE IN U.S.A.

Circle No. 18

Anderson™
BEDROOM ORGANIZER

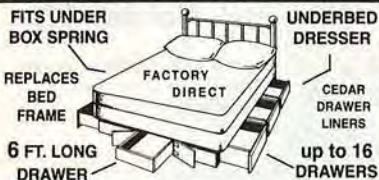

PUT A DRESSER UNDER ANY BED

Increase drawer storage with this beautiful, top quality, solid wood, dust proof, underbed dresser. Fits under any mattress. Shipped UPS
ORDER 48 PAGE CATALOG 621

1-800-782-4825

Circle No. 1795

FREE TOOL CATALOG

Helping You Become a Better Woodworker



highland hardware
Our giant tool catalog gives more than just manufacturer's specs. We provide detailed tool descriptions, useful techniques, as well as a schedule of educational seminars.

Call toll free for **FREE catalog**
1-888-500-4466

Visit us on the Internet at <http://www.highland-hardware.com>

Circle No. 870

TURNING TOOLS & SUPPLIES
Largest & Best Selection - **ANYWHERE**

PENS/PENCILS

Best Selection & Program - **ANYWHERE**

TURNING BLOCKS & SQUARES

Best Selection - **ANYWHERE**

PEN BLANKS

Biggest & Best Selection - **ANYWHERE**

WOODCRAFTERS

OF OKLAHOMA

5700 S. Western - Oklahoma City, OK 73109

TOLL FREE 1-888-333-7513

Circle No. 2195

FREE TOOL CATALOG!

Your Best Work Starts With Us!

With over 4,000 of the finest woodworking tools in the world, Woodcraft can help you work more efficiently and skillfully than ever. Call for your Free copy today.

1-800-542-9115

WOODCRAFT®

210 Wood County Industrial Park Dept. 97WI03T
PO Box 1686, Parkersburg, WV 26102-1686



Circle No. 955

PRICES SLASHED!!

SAVE UP TO 50%

STEEL BUILDINGS

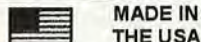

MADE IN THE USA

- Simple Construction
- 20 Year Warranty
- Easy Financing

Limited Time Offer

25' X 40' 30' X 50'
40' X 64' 50' X 100'

Low Monthly Payments!!



Workshop - Garage - Storage

AMERICAN STEEL SPAN

1-800-891-6733

24 HOURS

CALL NOW!!

SUPPLY IS LIMITED!!

Circle No. 1780

Create a Masterpiece!

America's Best Selection

- PRE-CUT KITS
- MOVEMENTS
- WOOD PARTS & FINE HARDWARE



Made in U.S.A.

FREE Clockmaker's Kit Catalog!

Call Today! 800-236-7300

The American Clockmaker

P.O. Box 326
Clintonville, WI 54929

Since 1940

Circle No. 2079

Circle No. 2320

Full-Size Professional Plan LIBRARY CHAIR/STEPS



Build this unique reproduction! American Empire in styling, this beautiful combination chair or library steps doubles as extra chair or sturdy steps for reaching shelves. As Chair: 17 1/4" wide, 18" deep, 33 1/2" high. As Steps: 33 1/2" high.

Plan #714 \$16.50 (catalog free with order)

CATALOG listing 200 full size professional furniture plans — \$3.00



FURNITURE DESIGNS, INC., Dept. BL-27
1827 Elmdale Ave., Glenview, IL 60025
(800) 657-7692

Circle No. 345

AMAZING SCROLLSAW FRETWORK PATTERNS
Easy to advanced designs

Clocks
Photo frames
Jewelry boxes
Candle holders
Furniture



Clock movements
Plywood

Silhouettes on Christmas religion farming western nature transportation & more.

Books
Saw blades
Hardwoods

FREE catalog

1-800-470-9090

WILDWOOD DESIGNS
P.O. Box 676-WD
Richland Center
WI 53581

Circle No. 475

RIPSAW

The Portable Sawmill.

The "affordable portable" one man band sawmill. Weighs only 45 lbs. Cuts 20" diameter logs into lumber. Minimum 1/8" to maximum 9" thickness. 14"W x 9"H throat capacity. Write or call for free brochure. Videos also available.



Better Built CORPORATION

(508) 657-5636
789 Woburn St., Dept. W2, Wilmington, MA 01887



PHARAOHS

Plans for a New and Unique Game of Strategy
Build • Play • Win and Win Again...

Each Plan • Pak Includes:

- Plans for Building the Board Game
- Templates for Etch or Inlay
- Rules and Que Cards for 2, 3, or 4 Players



- \$29.95 per Plan • Pak
- 3.00 Shipping and Handling
- 12.50 for Christmas RUSH (order by Dec. 15)

Mail your order with personal check or money order, to Thought Publishing along with your postal address:

Thought Publishing, Inc.

Route 4, Box 635
Hazlehurst, Georgia 31539

For Questions call
912-375-5390

Please allow six to eight weeks for standard delivery

Circle No. 2040

Flexcut CARVING TOOLS



Dealer inquires welcome



FALLS RUN WOODCARVING INC.
9395 FALLS ROAD, GIRARD, PA 16417
1-800-524-9077 OR 814-734-3690
http://www.fallsrun.com

Circle No. 2115

MAKE IT MOBILE

WITH HTC MOBILE MACHINE BASES

For a FREE Full-Color Catalog of HTC's Complete Product Line Call:
1-800-624-2027



Circle No. 1245

GREAT ENCOURAGEMENT FOR SHIPWRIGHTS!

All gentlemen shipwrights and able bodied modelists who have a mind to provide for themselves amusement and satisfaction through the traditional craft of ship modeling, an opportunity now offers to acquire, through the minimal cost of one Colonial Dollar (\$1.00), a catalog of fine and unique ship model kits, plans, books and fittings from the renowned company of Model Expo located in Mt. Pocono in the state of Pennsylvania.

Send \$1.00 for a catalog to:

MODEL EXPO, INC.
Dept. WD27, PO Box 1000, Mt. Pocono, PA 18344

Name _____
Address _____
City _____
State _____ Zip _____

Circle No. 1075

HUT Specials

Lathe

The Sherline is the most versatile mini machinist lathe on the market. Perfect for production pen turning. Packages start at \$455. Purchase now and receive \$50 in free HUT merchandise.



Pen Blanks

- Cocobolo/Bocote 20 - 1/2 x 6 blanks for \$9.95
- Stabilized Burl Blanks
- Cellulose Acetate Blanks
- Dymondwood
- Pen Mechanisms
- Turning Squares
- Bowl Blanks
- HUT Finishes

HUT Products for Wood for free catalog 1-800-547-5461

Circle No. 230

Her-Saf Router Bits



Reverse Helix Carbide Cutter
Screw-on for Quick Change
Available from 1/8" to 1-1/2"

Insert Router Bits

NEW

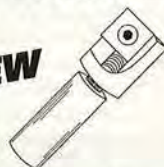

FREE Catalog
1-800-553-9344

Hands Free Clamping

A Flexible and Essential Tool For Every Shop



Her-Saf AIR-VAC-CLAMP

Safranek Enterprises, Inc.
4005 EL CAMINO REAL • ATASCADERO, CA

Circle No. 1366

RENAISSANCE

The Perfect Wax
It cleans, protects, restores,
polishes your valuable
machinery, tools,
furniture and much more!

200ml/7 Fl Oz
2 1/2 liter size available
Brochure Available
\$19.00 + \$4 s&h
plus NY tax where
applicable

WAX



Cutlery Specialties - Dept W
22 Morris Ln, Great Neck, NY 11024
Ph/Fax (516) 773-8076 (Sole U.S. Agent)

Circle No. 1912

Your Complete Source For Clockmaking Supplies

And now, your
handcrafted clock
could win you an
Alaskan cruise!
See details about
our sixth annual
Create-a-Clock
Contest in the new
spring catalog.
Call today
for your
FREE copy...



KLOCKIT 1-800-556-2548
Dept. WD27
<http://www.klockit.com>

Circle No. 2335

FREE WOODWORKER'S CATALOG



Over 5000 products to
**BUILD, REPAIR,
RESTORE, REFINISH**
anything made of wood!

It's the catalog woodworkers rely
on—jam-packed with fine woods,
veneers, tools, finishing supplies, and much
more—all top quality, all reasonably priced, all
with our 60-day no-questions-asked guarantee.



CONSTANTINE
Serving Woodworkers since 1812

2050 Eastchester Rd., Dpt. 35702, Bronx NY 10461
Call TOLL FREE 1-800-223-8087

Circle No. 20, 110

HEIRLOOM TOYS



- Original designs by professional toy maker featured in Wood magazine
- Collectors' and children's toys
- Plans and Kits
- Catalog \$3 or free with offer
- Special Offer: Send \$18.95 for Train Engine, Coal Car and Track Plans

Baldwin Toy Co., Inc.
P.O. Box 37014 Omaha, NE 68137-0014
Dept. WD02

Circle No. 320

SCROLL SAWING BLADES

BEST PRICES ON OLSON BLADES!

- Plain-end • 5" Long

- ◇ SKIP TOOTH BLADES
#OB-5, #OB-7, #OB-9
\$3.00/doz...\$24.00/gross
- ◇ REVERSE SKIP TOOTH BLADES
#OB-5R, #OB-7R, #OB-9R
\$3.50/doz...\$28.80/gross
- ◇ PRECISION GROUND TOOTH BLADES
#OBP-5, #OBP-7, #OBP-9
\$5.75/doz...\$57.00/gross

\$4.00 Shipping & Handling per order
WA residents add 7.7% sales tax
Visa, MC, DC, check, MO accepted
Other sizes available through catalog

800-206-9009 - THE BERRY BASKET
P O BOX 925-W20 • CENTRALIA, WA 98531
Fax 360-736-7336

Circle No. 323

Woodworkers Wanted!

The **Smithy 3-in-1 lathe-mill-drill**
gives you all 3 basic
machine tools for working
metal, plastic, or wood in
one easy-to-use
benchtop machine.
Smithy can help you
do it yourself. Call for
your FREE Info Pak
& video.



FREE
Machining
Basics video

1-800-345-6342

Ask for operator WOOD-M2



Dept. WOOD-M2 PO Box 1517
Ann Arbor, MI 48106-1517

Circle No. 99

Shops • Garages • Storage

Buy Manufacturer Direct -
SAVE THOUSANDS!

Limited Offer



30'x48' \$12,610 Value
NOW \$6,349

42'x60' \$19,075 Value
NOW \$9,750

- Easy Do-It-Yourself Construction
- Toll Free Technical Support
- Immediate Delivery or Free Storage

Pkgs. include steel frames & endwalls,
sheeting & trim. Some other sizes available.



1-800-843-8275

FAX 612-544-1835

WOOD

FREE! CherryTree

Woodcrafting Catalog



Wishing
Well Bird
Feeder & dozens
more NEW Spring
& Summer craft
projects!

Hundreds of
hard to find
Wood Parts plus

Tools, Plans, Clock Movements,
Toys, Whirligigs, Paints, Brushes
and more, at affordable prices with
guaranteed quality & Fast delivery!

NAME: _____

ADDRESS: _____

CITY: _____

STATE: _____ ZIP: _____

Cherry Tree • Box 369-W027
Belmont, OH. 43718-0369
or call TOLL FREE
1-800-848-4363 ext. W027

Circle No. 1985

Circle No. 1420

Secure the contents of your truck bed with the ROLL-TOP-COVER™



- Padded Leather-grain Top
- All Aluminum Undercarriage
- Key Lock Security • Fingertip Access
- Affordably Priced

**PAGE
EDWARDS**

For the dealer nearest you Call Toll Free!

1-888-ROLL-TOP
PAGE-EDWARDS CO.
2400 Commercial Blvd.
Centralia, WA 98531

You deserve a vacation... Our bandsaws will give you one

Who needs civilization when you have a Laguna Tools Bandsaw on a desert island? We give you more power, more re-saw and more Bandsaw for your money. Our European Bandsaws give you dynamically balanced cast iron wheels, professional guides, large blade capacities and heavy duty cast iron tables. Models range from 13" to 36".



Call now
**(800)
234-1976**
for your
FREE
demonstration
video
getting
you closer
to your
vacation.

LAGUNA TOOLS

2265 Laguna Canyon Road
Laguna Beach CA 92651
800-234-1976 • FAX 714-497-1346
lagunatools@earthlink.net

Circle No. 615

PRODUCTS THAT PERFORM



Continued from page 82

Tame sheet goods with Delta's sliding table

Are you tired of wrestling with large panels as you crosscut them on your tablesaw? The Sliding Table Attachment from Delta turns that tricky operation into a safe and easy procedure.

This aftermarket accessory comes predrilled to fit Delta Unisaws, Contractor's Saws, and Heavy-Duty Wood Shapers. It also can be adapted to similar machines from other manufacturers. The laminated $\frac{3}{4} \times 15\frac{3}{4} \times 24$ " table rides on seven ball-bearing guides that track back and forth on two precision-ground steel tubes. When you set the 42" extruded-aluminum fence at the front of the table, you can cut panels up to 25½" wide. But you also can set the fence at the rear of the table and clear workpieces up to 36" wide.

It took us a couple of hours to assemble and adjust the model 34-555 attachment. Once we had it set, we used it to trim the ends of a 2½×24×60" laminated maple

benchtop. The sliding table handled this workpiece easily and gave us perfect 90° cuts on both ends. Since then, we've found ourselves using this handy attachment far more than we initially thought we would.

The other heavy-duty sliding miter tables on the market give you about 12" more crosscut capacity than Delta's 36". But you'll pay extra for this added capacity, typically \$60 or more to crosscut full-width (4×8') sheet goods. But if the Delta table fits your needs, it represents a good value for the money.

—Tested by Chuck Hedlund and Jan Svec

PRODUCT SCORECARD

Delta Sliding Table Attachment

Performance ★ ★ ★ ★ ☆

Price About \$330

Value ★ ★ ★ ★ ☆

Delta International Machinery Corp.,
246 Alpha Dr., Pittsburgh, PA 15238.
Call 800/438-2486.



REMODEL YOUR FUTURE

Before



Let Foley-Belsaw train you in one of several high income professions where you can be the boss of your own business. It's that simple. If you're presently working for a large company or even another individual, you know where the profits go. While you may work hard to produce those profits, only a little ever trickles down to your pocket.

You can change all that with training in an area that you'll find interesting, rewarding and profitable. Since 1926, we've been training people like you to succeed in businesses of your own. With our exclusive Foley-Belsaw method of training you learn step by step the technical skills and the business skills you'll need to run your own profitable and successful business.

Best of all, Foley-Belsaw helps you every step of the way. Plus, once you start your business we're there to help you with technical support, parts, tools or inventory. You're the boss and we work for you.

It just makes sense! Call or send for your free opportunity kit today. Get the details about "hands on" training in one of these fast growing, profitable fields!

After

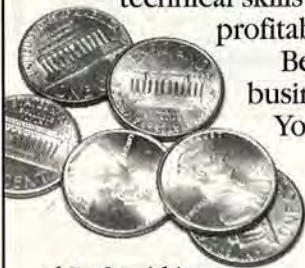

1 Locksmithing. As millions of Americans demand greater protection, this becomes a high demand field.

2 Small Engine Service & Repair. There are more than 65 million small engines in use today. You can make \$45 in just 1/2 hour for a simple tune-up and even more for many simple repairs.

3 Saw & Tool Sharpening. A business where 90 cents out of every dollar you take in is cash profit! You'll earn \$18 to \$25 per hour running machines that do the work.

4 VCR Cleaning, Maintenance & Repair. The VCR has become a basic part of nearly every American household. Make up to \$50 per hour in this fast growing field.

5 Upholstery. As furniture prices rise and quality noticeably decreases, it makes good sense to pursue a career in upholstery.

6 Professional Woodworking. Build over \$3,000 worth of valuable furniture while you learn! Create heirloom-quality furniture and save thousands on your own home repairs.

7 Computer Repair, Maintenance & Upgrade. The computerization of America is taking place! Jump on a high paying occupation with an unlimited future.

8 Computer Programming. Programmers with the right skills command top dollar. Learn computer languages.

9 TV/Satellite Dish. The demand is growing for the variety in entertainment only a satellite dish can provide.

10 Gunsmithing. Skilled gunsmiths charge up to \$50 per hour for simple repairs.

11 Vinyl Repair. Just a few days' practice and you're ready to do repairs for pay. This process is easy and the demand never ends.

12 Computer Specialist. Learn word processing, spreadsheet and data base applications.

13 Electrician. In a business of your own or working in the commercial or residential field you can make top dollar.

14 Networking Specialists. Learn the skills required to make big money tying Personal Computers together to make efficient operating systems.

Fill in and mail coupon below or

**Call Toll-Free
1-800-487-2100**

*to receive full information and details free by return mail.
DO IT TODAY!*



Foley-Belsaw Institute

6301 Equitable Road • Kansas City, MO 64120

Please Check Only ONE of the Following:

- Locksmithing 12914
- Small Engine Repair 52790
- Saw & Tool Sharpening 21729
- VCR Repair 62605
- Upholstery 81330
- Woodworking 43661
- Computer Repair 64502

- Computer Programmer 35325
- TV/Satellite Dish 31377
- Gunsmithing 92408
- Vinyl Repair 71263
- Computer Specialist 38168
- Electrician 95175
- Networking Specialist 39155

Name _____

Street _____

City _____ State _____ Zip _____

Or Call Toll-FREE 1-800-487-2100

IRONWOOD MILL•RIGHT 3-Axis Router Milling Center

New Concept High-Precision Milling Center Gives You...

TOTAL CREATIVE FREEDOM!

- Use as a Shaper, Router Table, Joint Maker
- Heavy-duty construction handles the most powerful plunge routers
- Precision ACME Leadscrews (adjustable 0.001 in.)
- Controlled Milling in bit-up or bit-down position
- Precision-guided router carriage
- High-quality cast iron tables

If you can imagine it, you can make it!

- **All through-cuts:** edge & face milling, raised panels, dovetails, box joints, tenons, splining, lap joints, rail & stile joints, dadoses and many more!
- **All stopped-cuts:** blind dadoses, blind dovetails, splines, face milling, mortises, and more!
- **Any angled cuts:** angled mortises, angled tenons, mitered splines, angled box joints, more!



Professional quality tool at a homeshop price!

NEW!

FREE CATALOG & DEMONSTRATION VIDEO!
Call TOLL FREE 1-888-478-2453

Or write: IRONWOOD MILL•RIGHT Wood Milling Center
 1737 Union St.- BOX 620, Schenectady, NY 12309

Ext. 113



© 1996, Positive Position, Inc

Circle No. 83

For that
"SPECIAL"
 project



OAK
 TABLE
 BASES

ALAMO

IN STOCK

**NO
 MINIMUM**



COUNTRY
 FRENCH
 LEGS IN MAPLE



TABLE
 LEGS IN
 MAPLE

**FREE
 COLOR
 CATALOGUE**



Adams Wood Products, L.T.D., L.P.
 974 Forest Dr., Dept. M 39
 Morristown TN 37814 • Phone (423) 587-2942

Circle No. 1002

COUNTRY BUFFET

See article on page 60



PARTS VIEW

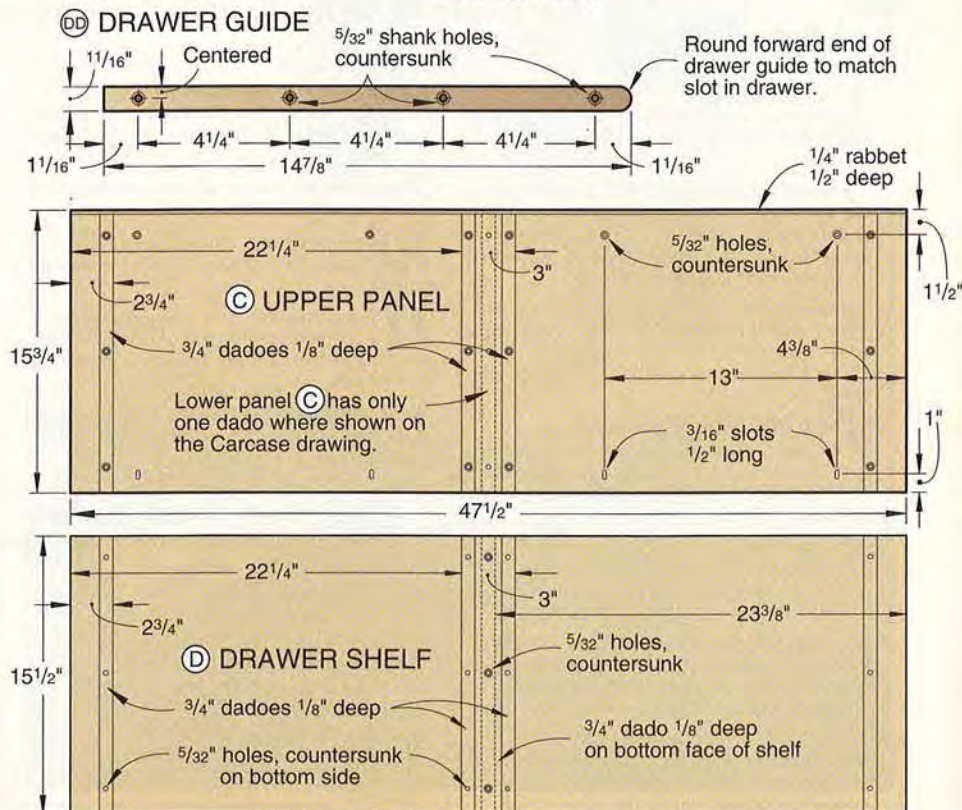

Woodworker's Resource

You can get useful ideas and product information by mail. Use the coupon in this section to order your choice of literature listed below. Each company mails the catalogs or information directly to you.

POWER TOOLS

SCROLL SAW, CRAFT & WOODWORKING CATALOG—Our '96 catalog features the 7 models of HEGNER Precision Scroll Saws, the consistent choice of the experts. Complete information on scroll saw blades and accessories is included. Also ZYLISS Portable Vise, ACCURA Benchtop Combination Machine, HEGNER Lathes and Duplicators, METABO Hand Tools and PLANO Vertical Glue Press information. **ADVANCED MACHINERY**. Free. Circle No. 3.

FREE WOODWORKING TOOL CATALOG—It may be your most valuable tool! Tool Crib of the North's 96-page catalog features the finest and most requested woodworking and construction tools available. Our knowledgeable sales staff, fast and efficient service, and guaranteed competitive pricing make Tool Crib of the North the place to start for your next project. **TOOL CRIB OF THE NORTH**. Free. Circle No. 6.

TRANSPOWER, CP TOOLS INC.—A fine line of quality woodworking machinery, saws, shapers, planers and more. Send for free catalog. **CP TOOLS INC.** Free. Circle No. 15.

CLAYTON MACHINE—Sand curved pieces with ease. New American-made oscillating spindle sander features many unique details. Quality built, for a lifetime of enjoyable and dependable service. Dust collector hook-up, ground steel top, dynamically balanced spindle with sealed oil-bath cam and quick change drums are all standard. Several models to choose from. Catalog. **CLAYTON MACHINE**. Free. Circle No. 18.

TOOLS AND ACCESSORIES—120 page color catalog features Porter-Cable routers, sanders, pocket hole cutters, and biscuit joiners, Tormek grinders, Vega lathe duplicators and saw fences, Vacu-Presses plus a huge selection of power tool accessories. Best quality, fairly priced, every tool backed by our 184 years' experience and 60-day money-back guarantee. **CONSTANTINE'S**. Free. Circle No. 20.

AT LAST! AN AFFORDABLE 14.4V CORDLESS DRILL—Forget paying \$200 or more for a quality 14.4-volt cordless drill. As part of a nationwide media campaign, the world's largest cordless drill manufacturer has authorized us to introduce their industrial 14.4v powerhouse at an unheard of \$69.95! Satisfaction guaranteed. **GREAT TOOLS DIRECT!** \$1.00. Circle No. 43.

HARBOR FREIGHT TOOLS CATALOG—The finest professional quality tools and equipment at the lowest prices...GUARANTEED! Our NEW Woodworking catalog has been expanded to contain hundreds of additional brand name woodworking tools & supplies. See why millions of woodworking professionals and Do-It-Yourselfers have shopped at Harbor Freight Tools for over 27 years. **HARBOR FREIGHT TOOLS**. Free. Circle No. 46.

CATALOGUE OF UNIQUE PRODUCTS FOR THE WOODWORKER—Filled with products and projects you can't find anywhere else. The 36-page full-color catalog features our complete line of Dust Collectors and accessories, Air Cleaners, Air nailers, Scroll Saws, Planers, and the exclusive Carbatec II variable speed mini-lathe and more. Explore our full line of projects and supplies including—pen kits, letter openers, perfume kits, kaleidoscopes, glass candles, project wood, and featuring the new and exclusive penlight flashlight kit. **PENN STATE INDUSTRIES**. Free. Circle No. 75.

DUST COLLECTOR SYSTEMS—Keep your shop clean and safe from saw dust with one of our large capacity Commercial Style Dust Collection Systems. Catalog features our new DC-3 1-1/2 H.P. Portable System. Free hose and adapters are supplied with any purchase. Full line of Dust Collection accessories is available from Penn State Industries. Catalog. **PENN STATE INDUSTRIES**. Free. Circle No. 75.

SURFACE PLANNER—Information package available from Penn State Industries describing the specifications and applications of its super 12x inch surface planer. Special discount pricing available on current promotion. **PENN STATE INDUSTRIES**. Free. Circle No. 75.

NOW'S THE TIME TO EXPERIENCE THE PERFORMAX DIFFERENCE—Minimize your sanding time with a

Performax Drum Sander and benefit from our ten year anniversary offer. Purchase a 16-32 Plus and receive a free Metal Stand (a \$100 value) or select the 22-44 Drum Assembly and receive free Tension Rollers (a \$50 value). Nine models to choose from. **PERFORMAX PRODUCTS**. \$1.00. Circle No. 78.

DRUM SANDER: UNIQUE, COST SAVING—Using plastic soda bottle as drum and sheet sandpaper with your power drill. Brass seals, water-filled for weight, cooling, firmness. Sanding surface 23% greater, 100% faster SFPM than belt sander. Hand-held, vertical through-the-table, and horizontal mount. **SANDACO CORP.** Free. Circle No. 79.

THE POWERMATIC CATALOG—Includes pictures, descriptions, and specifications of the complete Powermatic line of woodworking machinery. The catalog contains information on the heavy-duty production equipment as well as the Artisan line which is designed for the serious home woodworker. **POWERMATIC**. Free. Circle No. 81.

ROUTER MILLING CENTER—Turn your router into a precision wood milling machine with the innovative, patented Mill-Right from Ironwood Brand. Your router and the Mill-Right become a router table, panel raising machine, shaper, joint maker and more! Precision guides and precision lead screws let you mill wood with precision and repeatability. Cast iron construction. Use your plunge router for even great capability. **POSITIVE POSITION INC.** Free. Circle No. 83.

RBINDUSTRIES, WOODWORKING TOOLS & ACCESSORIES—100% Made in USA. The NEW 1996-1997 RB1 catalog features the all new HAWK Precision ULTRA Scroll Saws, "4-in-1" and "3-in-1" Universal Woodplaner Systems, and 26" Variable Speed Drum Sander, 38" Drum Sander, the all NEW Panelmaster II Raised Panel Door Machine, Router Tables, Books, Accessories, Patterns, and Much More. When you buy from rbindustries, you're saving big money by buying factory-direct from one of America's premier woodworking tool manufacturers. We stand behind every piece of equipment we manufacture with our exclusive 30-Day, Money Back Guarantee and 5-Year Warranty. Send today for your FREE catalog. **RBINDUSTRIES, INC.** Free. Circle No. 84.

THE ADVANTAGE—That's what you'll have over other woodworkers when you are using SECO MACHINERY. With choices of straight-line rip saws, wide belt sanders, dust collectors, power feeders, and lots...lots...more. Write today for a catalog of this woodworkers choice. Se habla espanol. Dealer inquiries welcome. Send for catalog. **SECO INVESTMENT CO.** Free. Circle No. 91.

TOOLS ON SALE™—A division of Seven Corners Ace Hardware, Inc. offers a catalog of over 400 pages of the most popular brands of power tools available anywhere, all at discounted prices. Included are saws, planers, sanders, routers, drills and more from manufacturers such as Milwaukee, Makita, Porter Cable, Black & Decker, Dewalt, Freud, Bosch, Delta, and many more. Now introducing a full range of Werner brand ladders. Tools on Sale™ division of **SEVEN CORNERS ACE HARDWARE, INC.** \$1.00. Circle No. 92.

WOODWORKERS WANTED!—The Smithy 3-in-1 lathe-mill-drill gives you all 3 basic machine tools for working metal, plastic, or wood in one easy-to-use benchtop machine. Smithy can help you do it yourself. Free info pak & video. **SMITHY**. Free. Circle No. 99.

HAND TOOLS

TOOLS THAT MAKE IT EASY!—Turning tools, carving tools, planes, scrapers, clamps, bits, squares, saws, stones, mallets, jigs—every tool you can think of and then some, in Constantine's 120-page full color catalog. **CONSTANTINE'S**. Free. Circle No. 110.

IMPROVE YOUR WOODWORKING SKILLS!—Craftsmen around the world have discovered the secret of better quality work. The 72 page Japan Woodworker Catalog is loaded with a huge selection of Japanese saws, waterstones, chisels, gouges, carving tools, planes, cutlery and garden tools. Send for 1992 catalog and all supplements for two years. **THE JAPAN WOODWORKER**. \$1.50. Circle No. 190.

STAINS/FINISHES

PERFECT PEN POLISH—NEW Developed for pens but great for any small lathe turned object. Pen Turning Manual, everything you need to know from wood selection to marketing. A complete line of pen making supplies—many styles of mechanisms, unusual pen turning materials such as dyed stabilized burls and spalted woods. Send for catalog of wood turning

and pen supplies. **HUT PRODUCTS FOR WOOD**. \$1.00. Circle No. 230.

PLANS

PATTERNS! PATTERNS! PATTERNS!—Huge assortment of popular shop-tested designs! OVER 1500 top-quality FULL SIZE PATTERNS conveniently grouped into 78 jumbo blueprint sets. We've also included easy-to-follow instructions, sketches, material lists, painting & finishing info. PLUS tips & techniques! Beginner or pro will enjoy creating 100's of fun, profitable projects. Discount prices, fast service, satisfaction guaranteed! Illustrated catalog PLUS sample pattern. **ACCENTS IN PINE**. \$2.00. Circle No. 310.

WOODWORKERS' PLANS AND SUPPLIES—Wood projects are simplified with the high quality plans, specialty hardware and other supplies offered by Armor Products. Over 100 plans are available for making toys, desks, clocks, pool tables, lamps, chests, and other furniture. Movements, dials, moldings, ornaments, dollhouse kits, door harp supplies and tuning pins are also available. **ARMOR PRODUCTS**. \$1.00. Circle No. 315.

HEIRLOOM WOOD TOY PLANS—You too can build The General train as featured in WOOD, Sept. 1994! Send for our catalog of plans, kits and finished toys. Unique plans for every skill level—arks, cars, trucks, trains and much more. Original designs, by professional toy maker, are based on an exclusive puzzle-concept. **BALDWIN TOY COMPANY**. \$3.00. Circle No. 320.

FREE SCROLL SAW PATTERN CATALOG—A beautiful full-color catalog showcasing our full line of woodworking patterns and accessories: shelves, mirrors, videos, books, baskets, blades, clocks, finials, drill bits, doll furniture, footswitches, and much, much more. Too much to list here—you just gotta send for one today! **THE BERRY BASKET**. Free. Circle No. 323.

"YOU CAN MAKE IT" CATALOG—This comprehensive 60-page catalog is one of the best resource books any woodworker can have. It shows hundreds of project plan ideas for indoor and outdoor furniture, outdoor structures, play gyms and playhouses, rocking horses, toys, doll houses, home improvement and a variety of woodworking books. The catalog also includes handy reference information on fasteners and a \$4.00 catalog rebate coupon. Request #WM96. **CRAFT PATTERNS, INC.** \$4.00. Circle No. 326.

FULL-SIZE FURNITURE PLANS CATALOG—Illustrates and describes over 200 plans for making furniture of quality found in fine furniture stores. Plans include rollout desk, cradles, beds, dining tables, chairs, buffets, chests, dressers, gun cabinets, Queen Anne lowboy and highboy, children's furniture, rocking horse, spinning wheels, Morris chair, Adirondack and English garden furniture and more. Bill of materials and exploded drawings assist the woodworker. Fine furniture plans since 1968. **FURNITURE DESIGNS, INC.** \$3.00. Circle No. 345.

GATTO PLAN SUPPLY—Stickler for Detail? Realistic Wood Block Models that you can build with your own scrap wood, dowels and my easy to follow instructions. Highly detailed PLANS of Classic & Antique Cars, Trucks, Tractor Rigs, Motorcycles, Construction Equipment, Farm Tractors, Fire Trucks, Steam Engines, and many more are designed for beginners to advanced woodworkers. PLANS are very thorough and the step-by-step instructions (with tips) proved to produce a collection to be cherished a lifetime. Plans from 50 to 250 separate parts. Brochure. **GATTO PLAN SUPPLY**. \$1.00. Circle No. 355.

ALL NEW BIRD FEEDER CREATION—Now available. Build as one, two, or three tiers from one plan. Plans include Bill of Materials list, cutting diagram, step-by-step instructions and scaled drawings to ensure precise procedures and tips necessary to complete our projects. Send for information. **GOOSE POND MILL**. \$2.00. Circle No. 365.

WOODWORKERS—Send for our NEW color catalog with many exciting plans available. Five Futon designs (no special hardware needed), Arbors, Archways, Trellises, Fences, Gates, Lighthouse, Windmill, Wishing Wells, Bird Feeders & Houses, Octagon Picnic Table with walk through seating PLUS new Children's design, Large selection Adirondack furniture including Tete-A-Tete, Rocking Glider (hardware available) and a variety of craft items. Full-size templates, material list, instructions and cutting diagram. **SPECIALTY FURNITURE DESIGNS**. \$3.00. Circle No. 445.

WOOD TOY PATTERNS—Patterns for all ages including children's patterns and executive toys. New catalog has many new patterns to choose from including parts and wheels. Send for new catalog today. **TOYS AND JOYS**. \$1.00. Circle No. 465.

SCROLLSAW FRETWORK PATTERNS—& supplies catalog. From simple cutouts to 50" tall clocks. Over 300 patterns for the scroll saw enthusiast. Also clock movements, tools, books, plywood, hardwood, sawblades. Great projects for the hobbyist or for profit. Catalog. **WILDWOOD DESIGNS, INC.** Free. Circle No. 475.

LUMBER

QUALITY EXOTIC LUMBER/TURNING WOODS—We offer a comprehensive selection of fine quality exotic woods. Also available are mechanisms for making wooden barrel pens/pencils/roller balls/fountain pens. Ebony, Kingwood, Tulipwood, Snakewood, African Blackwood, Cocobolo, Bloodwood, Figured Maple, Spalted Maple, Padauk, etc. Unique and unusual turning woods and burls are also available. Send for catalog. **BEREA HARDWOODS**. \$1.00. Circle No. 510.

ONE STOP WOOD SHOP—Domestic and exotic hardwood plywood and lumber, marine plywood, over 30 species in stock—all under one roof. Custom cutting services to your exact specifications with little or no waste at competitive prices! We specialize in bundling and shipping. Send for catalog. **BOULDER PLYWOOD CORP.** Free. Circle No. 512.

STEVE H. WALL LUMBER CO.—Quality hardwoods and woodworking machinery for the craftsman and educational institutions. 16-page catalog lists 17 species of popular hardwoods at wholesale prices. Also dealers for MiniMax, Freud and ProCut woodworking machines. **STEVE H. WALL LUMBER CO.** \$1.00. Circle No. 592.

VIDEOS

JOINTECH CABINET MAKER'S SYSTEM VIDEO—Watch Dr. Roger Cliffe and Dave Morgan demonstrate this patented system that can perform every operation in furniture and cabinet making. See how easy it is to make raised panel doors plus techniques in making dovetails, box joints, drawer construction and even an intricate double-inlay joint. All the operations which would normally require the use of a shaper, router and a jointer can now be accomplished with the JOINTECH CabinetMaker's System. **JOINTECH, INC.** \$5.00. Circle No. 610.

LAGUNA TOOLS VIDEO—Learn why most European workshops are using a central machine center rather than separate machines. 90 min. video presentation of "The Intelligent One Man Shop. The Robland X 31". Send for video. **LAGUNA TOOLS**. \$6.00. Circle No. 615.

GENERAL WOODWORKING CATALOGS

THE WOODTURNERS CATALOG—48 color pages of the finest woodturning tools, machinery and supplies available. Featuring Henry Taylor, Sorby, Richard Raffan and Dale Nish workshops. Catalog price refunded with order. **CRAFT SUPPLIES USA**. \$2.00. Circle No. 830.

GRIZZLY IMPORTS, INC.—Celebrate 1996 with our 178-page full-color catalog packed with an incredible selection of quality machines, tools, and accessories at prices you can afford. We've added over 1,000 new items this year alone! Send for your free catalog today and start enjoying tremendous savings on all your woodworking needs. **GRIZZLY IMPORTS INC.** Free. Circle No. 860.

HARTVILLE TOOL—Get your hands on some of the best woodworking tools and supplies around. All at the lowest prices everyday. Hundreds of items only available from us. Send today to receive your FREE catalog of over 900 unique woodworking tools. All guaranteed for life! **HARTVILLE TOOL & SUPPLY**. Free. Circle No. 865.

FREE WOODWORKING TOOL CATALOG—Helping you become a better woodworker. This giant catalog of hard-to-find woodworking tools and supplies gives more than just manufacturer's specs. Included are detailed tool descriptions, useful techniques, as well as a schedule of educational seminars. **HIGHLAND HARDWARE**. Free. Circle No. 870.

KREG TOOL CO.—Specializes in pocket hole tools, supplies and how-to videos for pocket hole joinery, including THE KREG JIG. Catalog also includes hinges, drawer slides, Crystalac water-based stains and finishes, KTC high quality router bits and more. **KREG TOOL COMPANY**. 50c. Circle No. 877.

THE WOODCRAFT CATALOG—Our FREE catalog features over 5,000 of the finest quality woodworking tools, books, lumber and hardware, all at rock bottom prices. If that's not enough, Woodcraft also offers technical assistance, tool sharpening, and something that no one else can do—same day shipping and an unconditional guarantee! Order a FREE copy today. **WOODCRAFT SUPPLY CORP.** Free. Circle No. 955.

THE WOODWORKERS' STORE CATALOG—The catalog that helps woodworkers do it right! Discover over 200 new products, including exciting items for making computer desks, entertainment centers, kaleidoscopes and humidors. Many exclusives and hard-to-find specialties like unique hardwoods, solid brass hardware, kitchen organizers, lighting systems and innovative tools—just to

name a few! Toll-free ordering. Satisfaction guaranteed! **THE WOODWORKERS' STORE**. Free. Circle No. 965.

KITS

OUR QUEEN ANNE FURNITURE KITS—are ready to assemble and finish. They include dining room chairs, a variety of occasional tables, and a personal desk. All are made in solid cherry, oak, walnut, and mahogany. We also stock individual Queen Anne legs for every project. Complete information in our brochure packet. **ADAMS WOOD PRODUCTS**. Free. Circle No. 1002.

SHIP MODELING CATALOG—Historic Ship Models—Museum quality replicas you build yourself. Pre-cut wooden parts, metal and brass fittings, cloth sails, plans and instructions. \$1.00 for 80 page color catalog. **MODEL EXPO, INC.** \$1.00. Circle No. 1075.

BUCKBENCH KIT—Kit includes steel springs that give a little, metal arms and back rails, hardware, and full-size instructions. New matching trestle table kit. **THE ROUDEBURG CO.** 50c. Circle No. 1085.

PUBLICATIONS

HOTTEST NEW SCROLL SAW PATTERNS AND TECHNIQUES—Check out "Patrick Spielman's Home Workshop News" a full-color, bi-monthly featuring trend-setting tips and ideas plus new project designs for scrolling fun and profit. Send just \$1.00 for a sample issue and a woodworking/pattern book. Catalog. **SPIELMAN PUBLISHING**. \$1.00. Circle No. 1142.

FREE WOODWORKING BOOKS!—Get 2 FREE woodworking books with the money-saving joining offer from Woodworker's Book Club. After you join, you have NO OBLIGATION to buy any more books. As a member, you'll get reviews of more than 100 of the newest and best woodworking books each month—every one discounted from 15–50%! Plus your satisfaction is guaranteed 100% on every book you buy. See our full page ad in this issue or send for FREE information. **WOODWORKER'S BOOK CLUB**. Free. Circle No. 1175.

SHOP ACCESSORIES

ECON-ABRASIVES—Offers a complete line of sandpapers and woodworking related accessories. We custom make abrasive belts in any size and in any grit. Catalog. **ECON-ABRASIVES**. Free. Circle No. 1229.

EASY DOES IT—with HTC'S power tool accessories. Discover many unique items, designed only with you, the dedicated woodworker, in mind. Make your machinery safer, increase the working area of your shop and accomplish nearly impossible tasks easily, quickly, accurately. Full-line catalog and price list. **HTC PRODUCTS, INC.** Free. Circle No. 1245.

WOOD MOISTURE METER—Avoid moisture defects such as cracking, warping, splitting, delamination. The pin-type moisture meter "Mini-Ligno" can read surface or core moisture in any thickness of lumber, from veneer through heavy timbers. A flat surface is not necessarily required, thus the Mini works on rough sawn lumber and curved or round pieces. A most versatile instrument. Many hobbyists and professionals use the Mini-Ligno C or E/C with attachments to monitor lumber during air or kiln drying or use external electrode for depth readings. Catalog describes complete line of moisture meters. **LIGNOMAT USA, LTD.** Free. Circle No. 1250.

ROUTER SPEED CONTROL—Reduces speed electronically without reducing torque. Route at the speed that gives best results with the wood and bit you are using. Speed adjustable from full speed to 0 RPM. Less tear out—stops burning—less wear on bits—easy to use. Send today for information. **MLCS LTD.** Free. Circle No. 1251.

LUMBER DRYING—Dry your own lumber using our equipment and your insulated chamber. Dehumidification systems from 300 BF to 45,000 BF. Easy to operate equipment offers high quality kiln-dried lumber for pennies per foot. These long-lasting made-in-the-USA units can pay for themselves in one month! Send for free catalog. **NYLE STANDARD DRYERS, INC.** Free. Circle No. 1260.

SUPERGRIT® SANDING/REFINISHING CATALOG CLOSE-OUT SHEET—Belts (aluminum oxide, silicone carbide zirconia), discs (plain, PSA, Hook & loop vacuum), sheets (cabinet, crocus, emery, non-loading, waterproof), rolls (cloth or hook & loop), bowl turning & lathe supplies, dust masks, scuff pads, tack cloths, tape. **RED HILL CORP.** Free. Circle No. 1267.

VEGA PRODUCT INFORMATION—Find out about the wide range of high quality woodworking machinery and accessories manufactured in the USA by Vega. Products include retro fit Table Saw Fences (3 models) with great accessories, Mitre Gauge, Tenon Jig, Sanders, Lathes (4 models) and Duplicating Equipment to fit any lathe. Vega's products feature innovative designs utilizing the finest materials. "Thoughtfully Designed Machines." **VEGA ENTERPRISES**. \$1.00. Circle No. 1281.

THE WORLD'S BEST TABLE SAW FENCE—Evolution & Pro-Rip manual saw fences for the hobbyist & professional user. Fits all table saws made. Welded steel, stress relieved

construction, yet has all the features the other guys have ignored. Free catalog, 30 day money back guarantee. **VOSS TECHNOLOGIES, INC.** Free. Circle No. 1283.

"WOOD-FRIENDLY"™ L606 MOISTURE METER—uses advanced electromagnetic wave technology to accurately measure wood moisture content from 6% to 30% to a depth of ¾". No pins to "abuse" wood and leave ugly holes. Check out boards from top to bottom in just seconds before you buy and avoid the headaches of splitting, warpage, delaminating and failed glue joints. The Wagner L606's convenient pocket size, easy-to-read analog meter, and low price make it a must for anyone working with wood. Literature. **WAGNER ELECTRONIC PRODUCTS, INC.** Free. Circle No. 1285.

UNCOMMON WOODWORKING TOOLS—American made quality router tables and fences, dovetail jigs, unique router biscuit joinery system, mortise machines, pin router, books, videos, commercial grade router bits and more. Buy from the manufacturer. Fast, friendly, knowledgeable service. **WOODHAVEN**. \$2.00. Circle No. 1290.

KEEP YOUR SHOP AND LUNGS CLEAN—Enjoy the benefits of a large yet mobile workbench. The Dust Eliminator Workbench removes dust from sanding before it becomes airborne. For dust created by other tools, common sense tells us that wood, even as dust, has weight and is affected by gravity making it more difficult to be collected above the woodworker's head. This is why it is much more efficient to collect dust particles at waist level. The workbench top is made of select and better grades of hard maple, the traditional choice of wood craftsmen. **WOODMARK**. \$1.00. Circle No. 1295.

BITS, BLADES, CUTTING TOOLS

FOUR-COLOR ROUTER BITS AND SAW BLADE CATALOGUES FROM CMT USA, INC.—Router bits and saw blades ideal for production work. Features include: Premium Fatigue-Proof™ steel machined from solid bar stock, anti-kickback design, sheer angle on cutting edges, CMX-4 micrograin carbide, radial relief on all straight bits, and a baked-on non-stick PTFE orange coating applied at 750°F. Saw blades have new sound-dampening channels laser-cut into the plate body of all 10" and larger blades, and anti-kickback shoulders. Router bits and blades come with sturdy hardened carrying case. Router bit sets are stored in a beautiful hinged hardwood case. **CMT USA, INC.** Free. Circle No. 1312.

PRODUCTION QUALITY CARBIDE TIPPED ROUTER BITS—Large discounts. New expanded catalog featuring a huge selection of Carbide Tipped Router Bits, Raised Panel Door Sets, Shaper Cutters, Solid Carbide Bits, The Router Speed Control, plus our unique line of clamps, tools and supplies. Save 50% to 70%. Value, quality, and prompt service guaranteed! **MLCS LTD.** Free. Circle No. 1350.

SCREW-ON CARBIDE TIPPED ROUTER BITS—Reverse Helix design for clean cutting. Wide variety of sizes—¾" to 1½" ±0.015. NEW Replaceable Carbide Tip Router Bits, available from ¾" to 1½" ±0.015, eliminates the need for sharpening—maintain the exact size, each insert has four cutting edges! Dependable quality tooling. **SAFRANEK ENT., INC.** 50c. Circle No. 1368.

INDUSTRIAL-QUALITY CARBIDE TIPPED ROUTER BITS & SHAPER CUTTERS—Great selection at the best prices for anti-kickback design router bits and shaper cutters. Same day service. Ask about our specials and free catalog. **WOODLINE ARIZONA INC.** Free. Circle No. 1395.

HARDWARE/ WOOD PARTS

FREE WOODCRAFT CATALOG FROM CHERRY TREE!—68 full-color pages of plans, parts, kits and supplies for all skill levels. Clocks, whirrigigs, dollhouses, door harps, banks and many more attractive items—plus wooden dowels, pegs, wheels, knobs, & more. Tools, paint supplies, stencils, stamps and much more! Wholesale prices available. Catalog. **CHERRY TREE TOYS**. Free. Circle No. 1420.

INCOME OPPORTUNITIES

FURNITURE MEDIC—We offer franchise licenses to qualified individuals to perform mobile, on-site furniture repair & restoration services. Furniture Medic has developed & patented a repair system and products that allows franchisees to go into customer's homes or businesses and repair damaged furniture. **FURNITURE MEDIC**. \$1.50. Circle No. 1520.

SECURE FUTURE IN FURNITURE RESTORATION WITH MINUTEMAN—Earn \$200–\$1,000 per day stripping, repairing, refinishing, mirror resilvering, veneering and more at home or in shop; part- or full-time. We provide complete training; no experience necessary. FREE workshop teaches you latest in furniture restoration. Featuring Amity, the first complete line of water-based furniture restoration products. Catalog. **MINUTEMAN**. Free. Circle No. 1661.

MISCELLANEOUS

AMERICAN STEEL SPAN BUILDINGS—Designed with the do-it-yourselfer in mind. Our buildings are made in a heavy gauge steel with a 20-year warranty. Everything is pre-cut and pre-drilled, and just bolts together. A quality pre-engineered building with style and structural integrity at a price that everyone can afford. 3 models to choose from! **AMERICAN STEEL MARKETING CORP.** Free. Circle No. 1780.

UNDERBED STORAGE DRESSER—Top quality, solid wood, ready-to-assemble kits provide convenient space-saving storage. Can have 3-16 drawers. Start at \$159.00. FREE freight for limited time. Send for FREE 44-page catalog. **ANDERSON MFG. CO.** Free. Circle No. 1795.

MECHANISMS FOR MAKING WOODEN BARREL PENS—Pencils/Roller Ball Pens/Fountain Pens. High quality. Low prices. Wholesale/Retail. Plus other related items. **BEREA HARDWOODS CO.** \$1.00. Circle No. 1900.

LOOKING FOR PIERCED TIN? COME TO THE SOURCE!—70+ page color highlighted catalog introduces you to a treasury of pierced metal panels affordably priced and ready to install in your woodworking projects. Available in a wide variety of sizes, 16 different types of metal (copper & brass, tool) & over 300 designs. Custom size & design a specialty. OR all the materials and tools needed to create it yourself. Catalog includes furniture plans you can order, lantern kits, specialized metal piercing tools and MORE. **COUNTRY ACCENTS.** \$5.00. Circle No. 1910.

RESTORATION PRODUCTS—"Renaissance" wax/polish cleans, protects, restores your valuable machinery, tools, furniture or wood products (raw and finished), antiques, fine art, leather, paper, and much more. The #1 choice of museums and galleries worldwide. Many other restoration/conservation/preservation products available, as well as cutlery and related cutlery items. Sole U.S. Agent for all general markets. **CUTLERY SPECIALTIES.** \$1.00. Circle No. 1912.

THE CUSHION CONTOUR SANDER—is a new concept in pneumatic drum sanding. Sanding sleeves are slid over an air bag (inflated with a hand tire pump) on an arbor to mount it between centers on a wood lathe. Drum effectively takes on profiles, curves, and bevels practically eliminating flat spots and chatter marks. **INDUSTRIAL ABRASIVES CO.** \$1.00 (refunded with first order). Circle No. 1976.

SUNSETTER® RETRACTABLE AWNINGS—Outsmart the weather! Don't let the hot sun or a passing shower stop you from enjoying your deck or patio. Send for our video and information package showing how SunSetter Retractable Awnings let you get far more use of your deck, rain or shine. **JIL INDUSTRIES.** \$1.00. Circle No. 1978.

NATIONAL FLOOD INSURANCE PROGRAM—Most homeowner's insurance policies don't cover flood damage. The NFIP's "Never Say Never" brochure tells you how to cover yourself from a potentially devastating loss. **NATIONAL FLOOD INSURANCE PROGRAM.** Free. Circle No. 1982.

TRUCK OWNERS, THE ROLL-TOP COVER™ IS QUICK AND EASY!—The Roll-Top Cover™ instantly rolls out to keep contents dry and secure. When not required it rolls into its small 9 1/2" storage canister for carrying tall loads. The full length handle can be easily operated with one hand from either side of the truck. Send for brochure. **PACE-EDWARDS CO.** Free. Circle No. 1985.

HI-TECH ENGRAVING—You don't have to be an artist with the System One High Speed Engraver (400,000 RPM). The incredible high speed combined with SCM's exclusive stenciling system allows you to produce professional results. You can engrave on wood, glass, metal, stone, ceramic, egg shell. It's as easy as writing with a pen. Send for information. **SCM ENTERPRISES.** \$1.00. Circle No. 1990.

STEELMASTER BUILDINGS—are available in almost any size for almost any use. From 10' to 100' wide and any length imaginable. Whether you need a back yard shop... an industrial shop... equipment storage building... whatever your requirements, you'll find a Steelmaster that's just the right size for the job. Our buildings are so easy to construct, most owners opt to construct their buildings themselves which adds up to even bigger savings. Send for information. **STEELMASTER.** \$1.00. Circle No. 2030.

PHARAOHS—A new game. Information about woodworking plans and game rules. Send for information. **THOUGHT PUBLICATIONS.** Free. Circle No. 2040.

IF YOU ARE INTERESTED IN RESTORING ANTIQUES—this 288-page catalog packed with unusual, hard-to-find items is just for you. Included are hundreds of essential items for antique restoration including top quality brass reproduction hardware, oil lamps and accessories, numerous wood component repair parts and kits, caning and basketry supplies, everything needed for wood refinishing, related tools, books, and a complete line of upholstery equipment and supplies. All at wholesale prices. Send for this informative catalog. **VAN DYKE'S RESTORERS.** \$1.00. Circle No. 2077.

WHOLESALE GLASS BROKERS—High quality glass shipped to your door directly from the finest manufacturers. Table tops; tempered glass; shelves; beveled glass; custom shapes; 1/4" to 3/4" thick; tinted glass; and much more! Your one-stop discount glass source. Idea catalog. **WHOLESALE GLASS BROKERS.** Free. Circle No. 2079.

PEN, PENCIL PRODUCTION SYSTEM—And equipment and supplies are detailed in free brochure. Anyone can produce high-quality pens and pencils from rare woods. The "WoodWrite" production system provides all equipment, supplies and consumables for your first 50 sets. Contact us for best prices on components and pre-cut, pre-drilled wood blanks. **WOODWRITE, LTD.** Free. Circle No. 2098.

CARVING SUPPLIES

FLEXCUT™ WOOD CARVING HAND TOOLS—High quality carving tools with spring shanks, designed for hard to reach areas. Excellent edge holding properties.

Low resistance cutting edge. Color brochure and video tape (6 minutes) explain advantage of flexible carving tools. **FALLS RUN WOODCARVING, INC.** \$2.50. Circle No. 2115.

WOOD CARVING MACHINES AND ACCESSORIES—make all types of wood carving easy, fun and profitable. The machines do the work. Whether for sign carving, flat 3-D, decoys, panels, gun stocks or furniture, we have the proper machine for the job. Professional woodcarving for the hobbyist and superior quality for the professional. Begin your hobby or full or part-time business by ordering our catalog and price list. **MARLIN INDUSTRIES.** \$1.00. Circle No. 2150.

PARAPHERNALIA—A sourcebook for everyone who loves to work with their hands. Consisting of ultra high speed engraving (315,000 RPM) carving equipment, training & supplies. We are the founders of ultra high speed engraving equipment & techniques. Serving & supporting since 1983. Free catalog available. Demo video available with refundable deposit. **PARAGRAPHS.** Free. Circle No. 2160.

WOODTURNING SUPPLIES

WOODTURNING SUPPLIES!—Best selection of woodturning supplies anywhere. Greatest selection of pen kits, pencil kits, project kits, boxes, and display cases available. Slimlines, "Mont Blanc," "Parker," bottle stoppers, etc. Over 250 different pen blanks including exotics, figured, acrylics, celluloids, and dywoodwoods. Carving supplies and books. **WOODCRAFTERS OF OKLAHOMA.** Free. Circle No. 2195.

CLAMPS

MERLE ADJUSTABLE CORNER CLAMP—Quick & easy to use. It forces your work into square. Fully adjustable from 2 1/2" x 2 1/2" to 69" x 69" in. Perfect for clamping picture frames, cabinets, or anything that requires 90° corner clamping. The Merle Clamp is cast aluminum & steel construction, a true industrial quality tool. Send today for information. **MLCS LTD.** Free. Circle No. 2250.

CLOCKS

CLOCK KITS AND CLOCKMAKING COMPONENTS—America's leading source for highest quality, traditional do-it-yourself clocks and clock parts. Selection includes desk clock kits (complete with movement, dial and glass) for under \$20 to elaborate grandfather clock kits with German brass tubular chime movements. Always the lowest prices because all woodwork is produced in our factory. Catalog also features a broad selection of quartz and brass movements, quartz fit-ups, dials, wood finishes and hard-to-find clock hardware, all at very competitive pricing. Write today for the most complete product selection for clockmakers! Catalog. **THE AMERICAN CLOCKMAKER.** Free. Circle No. 2320.

KLOCKIT—The leading supplier of clock-making supplies for over 25 years: Quartz and mechanical movements, clock inserts, dials, easy-to-follow plans and kits for all skill levels. **KLOCKIT.** Free. Circle No. 2335.

CLOCK PARTS CATALOG—For the hobbyist and clock enthusiast. Contains clock parts, quartz and mechanical clock movements. Tools for the hobbies and clock repair person. Gift ideas include complete clocks, watches and novelty items. Your satisfaction guaranteed. **S. LAROSE, INC.** Free. Circle No. 2375.

SCHLABAUGH & SONS WOODWORKING—Easy-to-build—all original designs—clocks, bookends and hand mirror kits. Clock movements, jigs and jig-making accessories, pre-laminated hardwood project blanks & turnings, exotic woods, clamps and many exclusive design ideas. Family-owned business—we offer 100% guarantee. Order our catalog & get to know us! Toll-free ordering. Full-color catalog. **SCHLABAUGH & SONS WOODWORKING.** \$1.00. Circle No. 2385.

FASTENING PRODUCTS

SQUARE DRIVE SCREWS—Thousands agree—once you try them you will never want to use anything else! The square drive recess virtually eliminates work-damaging driver bit "cam-out," the deep threads result in exceptional holding power, and they are heat treated for strength. Sizes from #4 x 3/8" to #12 x 4", with stainless steel, solid brass, brass plated, and zinc plated available. Quantity discounts. Send for literature. **McFEELY'S.** \$1.00. Circle No. 2450.

SHOWS & SEMINARS

'THE WOODWORKING SHOWS' MACHINERY, TOOLS AND SUPPLIES—Hundreds of products for the woodworker demonstrated and sold at discount prices at every "Woodworking Show". In-depth seminars and free workshops on a variety of woodworking topics. Shows are scheduled in 27 cities. Send for free brochure. **'THE WOODWORKING SHOWS'.** Free. Circle No. 2900.

Woodworker's Resource

TO ENSURE PROMPT HANDLING OF YOUR ORDER FOLLOW THESE INSTRUCTIONS:

- Circle your choice
- Enclose check or money order for cost of booklets plus \$2.00 service charge (no stamps accepted)
- Send coupon and remittance to address above
- ALLOW 4-6 WEEKS FOR DELIVERY
- Coupon expires March 12, 1998

WOOD SUBSCRIPTION

A 1 year WOOD subscription (9 issues) for \$25.00 (U.S. price)—a \$19.55 savings off newsstand rate (Circle No. 4000). Allow 6-8 weeks for first issue. Be sure to include payment with total below.

Circle numbers below corresponding to items in this issue. Please include \$2.00 for handling charge.

3.....Free	92.....\$1.00	465.....\$1.00	1002.....Free	1290.....\$2.00	1976.....\$1.00	2250.....Free
6.....Free	99.....Free	475.....Free	1075.....\$1.00	1295.....\$1.00	1978.....\$1.00	2320.....Free
15.....Free	110.....Free	510.....\$1.00	1085.....50c	1312.....Free	1982.....Free	2335.....Free
18.....Free	190.....\$1.50	512.....Free	1142.....\$1.00	1350.....Free	1985.....Free	2375.....Free
20.....Free	230.....\$1.00	592.....\$1.00	1175.....Free	1368.....50c	1990.....\$1.00	2385.....\$1.00
43.....\$1.00	310.....\$2.00	610.....\$5.00	1229.....Free	1395.....Free	2030.....\$1.00	2450.....\$1.00
46.....Free	315.....\$1.00	615.....\$6.00	1245.....Free	1420.....Free	2040.....Free	2900.....Free
75.....Free	320.....\$3.00	830.....\$2.00	1250.....Free	1520.....\$1.50	2077.....\$1.00	4000.....\$25.00
78.....\$1.00	323.....Free	860.....Free	1251.....Free	1661.....Free	2079.....Free	
79.....Free	326.....\$4.00	865.....Free	1260.....Free	1780.....Free	2098.....Free	
81.....Free	345.....\$3.00	870.....Free	1267.....Free	1795.....Free	2115.....\$2.50	
83.....Free	355.....\$1.00	877.....50c	1281.....\$1.00	1900.....\$1.00	2150.....\$1.00	
84.....Free	365.....\$2.00	955.....Free	1283.....Free	1910.....\$5.00	2160.....Free	
91.....Free	445.....\$3.00	965.....Free	1285.....Free	1912.....\$1.00	2195.....Free	

Name (please print) _____ **I AM ENCLOSING:**
 Address _____ \$ _____ for priced items
 City _____ \$ 2.00 for handling
 State _____ Zip Code _____ \$ _____ total remittance
 Phone (Optional): _____ (US dollars only)

Take our scrollsaw safety course



Keep scrollsawing an accident-free woodworking experience by following these helpful tips:

- **Know your owner's manual** and follow it to set up, adjust, and maintain your saw.

- **Plug the tool into a properly grounded outlet**, and make sure any extension cord you use is in safe condition.

- **Protect yourself against sawdust.** Arrange the sawdust-blower tube to direct the airflow away from you, off to the side, or better yet, toward the back of the saw. Wear a dust mask.

- **Wear eye protection.** Goggles keep sawdust out of your eyes, as well as other flying debris that might come from the tool or the wood you're sawing.

- **Dress for success.** Avoid loose clothing and dangling jewelry. Tie back long hair or wear a cap.

- **Keep your workplace tidy.** Don't let sawdust and cut-off pieces pile up in front of the saw. Provide plenty of task lighting. Special magnifier lights work best of all.

- **Hold the stock down firmly with your fingertips** when cutting for maximum control. Keep the work flat on the saw table. Don't try to saw unsupported stock. If the work catches on the blade and starts flapping up and down, stop the saw.

- **Before you start the saw, ensure that the blade is properly tensioned**, that the blade teeth point down, and that the hold-down and table-tilt knobs are adjusted and tightened.

 Print this article

One Stop Wood Shop

- Plywood & Veneer made to order (no min.)
- 30 species
- Custom Cutting
- Competitive Pricing
- We bundle & ship to U.S. & Canada
- Over 65 years of personal service

For catalog & quote: (617) 666-1340

Boulter Plywood Corp.

24-WD Broadway, Somerville, MA 02145

Where the finest cabinetmakers select & blend domestic & exotic hardwood in plywood, veneer & lumber.

Circle No. 512

WOOD

Having Fun Making Money...

A Dream Come True for Woodworkers.



For Keith Hone, a Utah native, making money and having fun go hand in hand. Using the new ultra high speed engraving technology developed by the Paragraphics Corporation, Keith can engrave beautiful designs on virtually any surface. The demand for this type of work is tremendous!

It's fast... and easier than you might think!

With an easy-to-use stencil system, you can transfer any design, artwork, or logo to any hard surface. By simply tracing lines using the Paragraph handpiece spinning at speeds of over 300,000 rpm, you can create beautiful carvings and engravings and the system does the work for you. It's that simple!



Call 1-800-624-7415 and get your demonstration video today to learn more about how you can make money and have fun too!

Paragraphics
CORPORATION

1-800-624-7415

Circle No. 2160

1455 W. Center Orem, Ut 84057



"QUALITY PERFORMANCE... WIDE RANGE OF DESIRABLE FEATURES... AT A FAIR PRICE."

BETTER HOMES AND GARDENS® **WOOD®**
OCTOBER, 1996

The RBI Hawk Ultra 220 Scroll Saw

- **ULTRA-SMOOTH CUTS**
- **QUICK RELEASE BLADE CLAMPS**
- **VISUAL BLADE TENSION SYSTEM**
- **EXCELLENT CUTTING CONTROL**
- **STACK CUT UP TO 2-3/4"**
- **VARIABLE SPEED CONTROL**
- **DC POWER AND TORQUE**
- **LARGE TABLE DESIGN**
- **HEAVY-DUTY STEEL LEGS**



Visit the RBI Home page at <http://www.rbiwoodtools.com>

G102

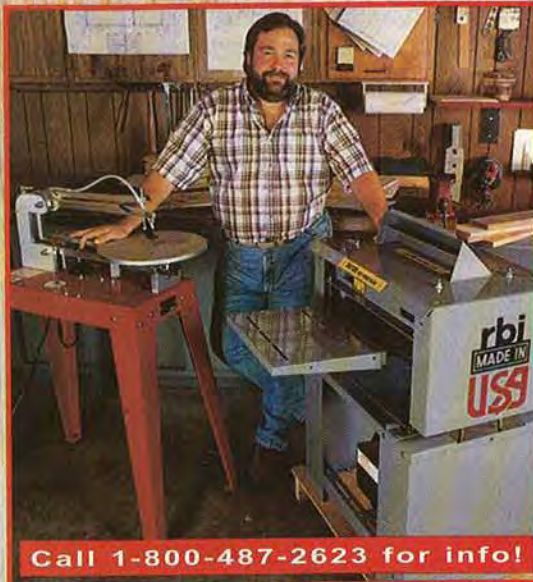

Call 1-800-487-2623 for info!

rbindustries, inc.

America's Woodworking Machinery Manufacturer

1801 Vine Street • PO Box 369 Harrisonville, MO 64701

Copyright © 1996 rbindustries. All rights reserved.

SUBSCRIBERS: PLEASE NOTE!

Many of our customers are mail-order buyers. These consumers are interested in receiving offers for other products and services from our company (Meredith Corporation) and for products and services offered by other reputable companies.

In order to promote our other products, we retain your name and address in a prospective customer file. We also provide that name and address to other reputable companies who offer products we consider to be of value and interest to our customers.

However, we also respect the rights of those customers who prefer not to receive additional mail-order offers.

Should you prefer to have your name restricted, please fill out the coupon (below), clip it out, and mail it to the address shown. Please be sure to indicate whether you wish to restrict all offers or just those from other companies.

- I will accept offers from Meredith Corporation only.
- I prefer not to receive any offers.

Include a current magazine address label with this coupon, and mail your request to:

Magazine Customer Service
P.O. Box 10263
Des Moines, IA 50336-0263

**If you were stranded on an island...
What is the one machine you
couldn't live without? The X31!**

Gilligan would have made it back to civilization sooner, if he had our X31 Combination machine.

- 38" Rip Capacity Saw
- 10" Table Saw
- 50" Cross Cut
- Mortiser

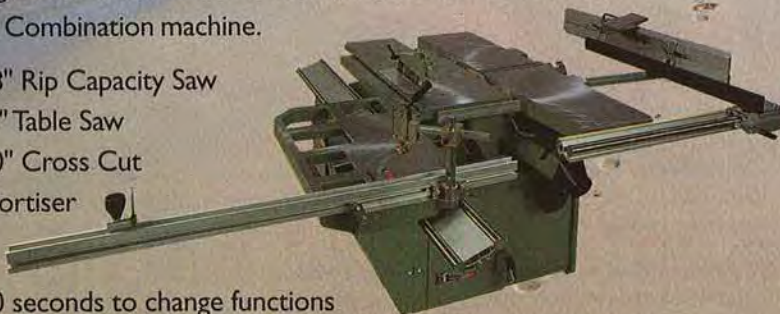

- 20 seconds to change functions
- 12" Jointer/Planer
- Cast Iron Tables
- Three 3HP German Motors
- 3HP Reversible Shaper

Don't get left stranded in the sand...call (800) 234-1976 today, for your **FREE** demonstration video.

LAGUNA TOOLS

2265 Laguna Canyon Road • Laguna Beach CA 92651
800-234-1976 • FAX 714-497-1346 lagunatools@earthlink.net

Circle No. 615

The World's Most Versatile Dovetail Jig, Period.



The Leigh D4 Dovetail Jig and your router will cut half-blind and through dovetails with *infinite adjustment* of pin and tail spacing! And all with a beautiful hand-cut look. Creativity has never been easier. Also cut sliding, simple obtuse, acute, compound, and angled dovetails. And our optional F1 Finger Joint Template gives you nine different sizes of box joint from 1/8" to 1/2".

Call For Your Free 32-Page Catalog Now!

1-800-663-8932

LEIGH

Joining Tradition with Today

Leigh Industries Ltd., PO Box 357, Port Coquitlam, BC, Canada V3C 4K6
Tel. 604 464-2700 Fax 604 464-7404

EARN \$\$\$ as a Home Inspector!



Home Inspectors Are in Demand!

Turn your interest in home construction into a lucrative career! Whether you want to start your own business or earn some extra money on the side, you could be in demand as a Home Inspector. Every day, approximately 10,000 existing houses are bought and sold, many with the help of a qualified Home Inspector. Consumers, banks, and mortgage companies often hire Home Inspectors to check for hidden problems in order to protect their investments. And at an average of \$100.00 to \$300.00 per job, Home Inspectors earn good money for their work!

Get Complete Home Inspection Knowledge!

You don't need any previous experience—ICS teaches you all the fundamentals! With the ICS Home Inspector Program you'll learn how to check the complete home site, spot hidden defects in structural supports, inspect the interior walls, floors, ceilings, heating systems, and more. You'll learn inspection procedures for insulation and air quality, plus how to do pollutant inspections and energy audits. You'll become familiar with VA inspection forms, ADA inspection checklists, and code compliance—all the skills you need to take advantage of home inspection opportunities.

Convenient, At-Home Training

Learn at home in your spare time—ICS sends lessons, supplements and equipment directly to your door! Study as fast or as slow as you want—you set your own schedule. You can earn your Career Diploma in as little as nine months, or take up to two years to complete your training. The lessons are clear and illustrated with easy-to-read

diagrams. And with **DIAL-A-QUESTION®**, our toll-free 24-hour hotline, qualified instructors will give you answers to your study questions. Plus, your training is accredited by the Accrediting Commission of the Distance Education and Training Council—listed by the U.S. Department of Education as a nationally recognized accrediting agency of all distance-education schools.

Start Now!

Get free information on the Home Inspector Program or one of the other great ICS programs. Check the ONE box on the coupon that corresponds to the program and **SEND FOR FREE FACTS TODAY!**

285Y



SCHOOL OF PROPERTY MANAGEMENT

Dept. A8DS27S, 925 Oak Street, Scranton, PA 18515

YES! Send me free facts about how I can train for an exciting new career. Choose any ONE of the programs below, fill in your name and address, and mail it to ICS. I understand I am under no obligation, and no salesman will visit me.

- | | | |
|--|--|---|
| <input type="checkbox"/> 15 Home Inspector | <input type="checkbox"/> 25 Gun Repair | <input type="checkbox"/> 70 Small Business Management |
| <input type="checkbox"/> 04 Automotive Mechanics | <input type="checkbox"/> 79 Electronics Technician | <input type="checkbox"/> 43 PC Fundamentals* |
| <input type="checkbox"/> 87 TV/VCR Repair | <input type="checkbox"/> 33 Motorcycle Repair | <input type="checkbox"/> 27 PC Repair |
| <input type="checkbox"/> 06 Electrician | <input type="checkbox"/> 60 Business Management (ASB Degree Program) | <input type="checkbox"/> 44 A+ Cert. Test Prep.* |
| <input type="checkbox"/> 14 Air Conditioning & Refrigeration | <input type="checkbox"/> 55 Diesel Mechanics | <input type="checkbox"/> 07 High School |
| <input type="checkbox"/> 62 Mechanical Engineering Technology (AST Degree Program) | <input type="checkbox"/> 22 Wildlife/Forestry Conservation | <input type="checkbox"/> 89 Small Engine Repair |
| <input type="checkbox"/> 63 Civil Engineering Technology (AST Degree Program) | <input type="checkbox"/> 31 Professional Locksmithing | Computer Programming |
| | <input type="checkbox"/> 38 PC Specialist | <input type="checkbox"/> 01 QuickBASIC |
| | | <input type="checkbox"/> 37 Visual Basic |
| | | <input type="checkbox"/> 36 Visual C++ |

* For personal enrichment

PLEASE PRINT

Name _____ Age _____

Address _____ Apt. # _____

City/State _____ Zip _____

Phone () _____

If coupon is missing, or for faster service, call toll free:

1-800-595-5505

ext. 2398

Call anytime—24 Hours a day, 7 days a week.

<http://www.icslearn.com>

20-MINUTE TIMEPIECE

A quick, easy turned watch

Busy schedule? Here's help in keeping it—an attractive pocket watch that shows the time at a glance. Even better, you'll spend only a few minutes turning it.

Project Prep

Stock

3/4"-thick domestic or exotic hardwood, large enough to yield a round blank about 3" in diameter.

Turning tools

- 3/16" (or other small size) gouge
- 1/2" gouge
- 1/2" roundnose scraper
- 1/8" parting tool

Lathe equipment

3" faceplate

Turn the front first

1 Trace around your 3"-diameter metal faceplate onto one side of a 1"-thick piece of scrapwood. Glue a piece of 3/4"-thick stock for the watch body to the other side of this wasteblock. (The side glued to the wasteblock will be the back of the watch body.)

2 Bandsaw the lamination around the faceplate outline. Drill pilot holes in the wasteblock, and screw it to your metal faceplate.

3 Mount the faceplate on the lathe. With the lathe running at about 1,500 rpm, turn the blank to 2 1/2" diameter and flatten its face. The 1/2" gouge works fine for this.

4 With the lathe still running, mark a 1 3/8"-diameter circle on the face of the blank. To do this, lay a pencil on the toolrest, then bring

the point up to the blank to draw the circle accurately and on center.

5 Using the pencil mark as a guideline, turn a 1 3/8"-diameter recess 1/4" deep with a flat bottom to hold the clock insert. To begin, come straight into the face of the blank with the parting tool, just inside the pencil line. Cut in about 1/8" deep. Shut off the lathe, and check the diameter of the circle. If it's 1 3/8", finish cutting straight in to a depth of 1/4", and clean out the recess with a small gouge. Check the fit of the clock insert in the recess.

6 Turn the edge and front profile, following one of the Full-Sized Section Views or your own design. Sand the front and apply a finish, then part off the turning.

A jam chuck completes it

1 Hold the blank with a jam chuck while turning the back of the case. To make the chuck, form a 1 3/8"-diameter tenon on the wasteblock. The recess in the turning must fit snugly over this tenon to complete the turning, so test the fit frequently as you turn it.

2 Turn the back of the watchcase to one of the profiles shown. Or, create your own design. Sand and finish, then remove the completed case from the jam chuck.

3 Drill a 3/16" hole 1/16" deep centered on the top edge of the case. In the bottom of the hole, drill a 5/64" hole 5/16" deep. Dab epoxy glue

onto the threads, then screw the post for the watch chain into the hole. Press the clock insert into the case recess.

4 Drill out the post's eye hole to 7/64". Support the post with scrapwood, and drill the hole with a drill press, as shown below. Snap the chain hook into the hole.



Support the post with scrapwood while you drill it to accept the chain hook.

Buying Guide

Clock insert, watch chain. Quartz insert, Roman or Arabic numerals (specify choice), and watch chain with post and belt clip, 15" long overall, item PW-KIT \$23.95 ppd. in U.S. Schlabaugh and Sons Woodworking, 720 14th St., Kalona, IA 52247, or call 800/346-9663 to order.

Photographs: King Au; John Hetherington
Illustrations: Roxanne LeMoine

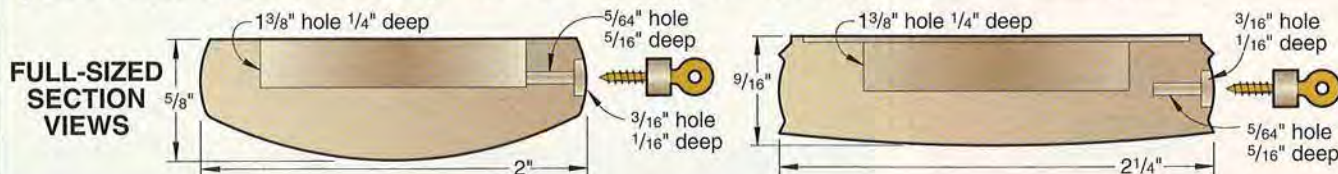

14" BAND SAW
\$ 265.00



DRUM
BRUSH SANDER
\$ 310.00



6" JOINTER
\$ 345.00



3 HP 1" SHAPER
\$ 695.00



10" HEAVY
DUTY
TABLE SAW
\$ 1,075.00



20" PLANER
\$ 1,225.00



TRANSPOWER

Tel: 818-815-9897
Fax: 818-815-9807
Order Desk: 1-800-654-7702

CP TOOLS, INC., 611 DUGGAN AVE., Azusa CA 91702

Circle No. 15

• STEEL BUILDINGS •

FREE INFORMATION

©1996 ShuffMaster



- Perfect Back-Yard Shop
- Easy Financing Available
- Build-It-Yourself

Save on Select Sizes:
25x36 • 30x48
45x82 • 50x120



Ask about our Factory specials
and save even more!



**FACTORY
DIRECT**
FROM THE FACTORY TO YOU

Call Now for FREE Info
1 800 888-4606
(Alaska & Hawaii dial 1-800-527-4044)

Circle No. 2030

"Out Ahead of the Pack..."

— American Woodworker 10/96

WOOD Magazine, CREATIVE WOODWORKS, AMERICAN WOODWORKER, and thousands of Hegner owners agree that HEGNER saws offer many advantages over all other brands. Try one yourself and discover the benefits:

- clean, accurate cuts with no sanding
- easy blade change
- smooth quiet operation
- long blade life
- Safety-Stop upper arm
- Space-saving design
- 6 year warranty



Call or write for your FREE 1997 Catalog

1.800.322.2226

(Please mention Ad 770)

ADVANCED MACHINERY

P.O. Box 312 • New Castle, DE 19720
<http://www.advmachinery.com>

Send me FREE information on
Hegner Scroll Saws !

Name _____

Address _____

City _____ State _____ Zip _____

Phone _____ 770

HEGNER makes it better!

Circle No. 3

Model	Description	List Sale
31-280	Sanding Center w/stand	1250 789
31-695	6" Belt/9" Disc Sander	441 349
23-700	Wet/Dry Grinder	206 149
23-710	New Sharpening Center	217 169
23-660	6" Bench Grinder 1/4 HP	80 69
11-950	8" Drill Press	176 128
31-460	4" Belt/Disc Sander	198 135
40-560	1/2" speed Scroll Saw	230 165
40-540	NEW 1/4" var/spd Scroll Saw	249 184
11-990	12" Bench Drill Press	255 184
41-505	32" Radial Bench Drill Press	405 305
22-540	1/2" Bench Router/Shaper	399 289
26-220	10" Compound Miter Saw	294 199
28-185	Bench Band Saw	213 168
28-070	NEW 6" v/spd Bench Jointer	351 259
13-650	Hollow Chisel Mortiser	380 239
34-900	10" Radial Arm Saw	981 779
33-055	8-1/4" Sawbuck comp w/legs	846 665
33-905	30" Unifence	346 245
36-905	50" Delta Unifence	444 319
36-755	10" Tilling Arbor Saw	546 419
17-900	16-1/2" Floor Drill Press	490 399
37-190	6" Deluxe Jointer	603 489
36-275	8-1/4" Builders Saw	358 268
36-210	10" Compound Miter Saw	344 225
36-040	8-1/4" Compound Miter Saw	190 135
36-070	10" Miter Saw	217 165
34-555	Sliding Table	487 325
34-440	10" Contractors Table Saw	587 459
36-250	10" Slide Compound Saw	825 489
36-230	12" Compound Miter Saw	480 345
31-780	Oscillating Spindle Sander	253 195

DELTA REBATES!
Prices shown are before rebate!
Rebates valid thru 3/31/97.

Model	Description	List Sale
46-700	12" Wood Lathe	\$50.00 rebate 575 465
28-275	14" Band Saw 3/4 HP	Sale 635
28-280V14	Band Saw 1 HP motor	Sale 798
34-445	10" Table Saw w/30" fence	Sale 839
22-675	NEW DC380 15" Planer	Sale 1175
43-355	3/4" Shaper 1-1/2 HP	\$75.00 rebate
37-154	6" Jointer DJ-1	Sale 1289

MILWAUKEE TOOLS

Model	Description	List Sale
6527	NEW Sawzall with case	343 169
6528	above Sawzall w/wired cord	339 185
6537-2	6527 w/quick lok blade change	224 175
0408-6	12V Drill w/keys chuck & batt	380 172
0224-1	3/8" Drill 4.5 amp magnum	236 132
0234-1	1/2" Drill 4.5 amp 8-850 rpm	255 129
0235-1	1/2" Drill w/keyless chuck	255 129
0244-1	1/2" Drill 4.5 amp 6-600 rpm	255 129
0222-1	3/8" Drill 3.5 amp 0-1000 rpm	213 119
0228-1	3/8" Drill 3.5 amp 0-1000 rpm	207 118
0375-1	3/8" close quarter Drill	255 148
0379-1	1/2" close quarter Drill	289 165
6546-1	cds Screwdr 200 & 400 rpm	150 89
6547-1	6546-1 w/bits, 1/4" chuck & cs	185 108
5399	1/2" D-handle Hammer Drill	356 194
6507	Original SawZall with case	278 149
5397-1	3/8" v/spd Hammer Drill	275 145
9107-1	1/2" v/spd right angle Drill	314 194
3300-1	1/2" v/spd right angle Drill	378 199
5680	Router 2 HP w/collets	367 165
6142	4-1/2" Grinder w/case & acc.	224 125
6368	7-1/4" Circular Saw 13 amp	229 125
6358	6365 w/fence, blade, & case	259 142
6256	Top Handle Jig Saw	278 149
6490	10" Miter Saw	496 265
6491	6490 w/carbide blade & bag	594 328
6494	10" Compound Miter Saw	585 315
0431-1	12V Drill w/2 batteries	441 239
6266-6	NEW Top Handle Jig Saw	315 165
6496	10" Slide Compound Saw	1050 569

FREUD CARBIDE TIPPED SAW BLADES
5/8" Bore - Industrial Grade

Item	Description	Teeth	List Sale
LW2M010	Gen Pur. A.T.B. 10"	60	69 42
LW8M010	Cut-off 10"	60	93 44
LW8M011	Comb 10"	50	78 42
LW8M010	Super Cut-off 10"	60	115 59
LM7M010	Ripping 10"	24	69 38
LW7M010	Cut off 10"	60	84 45
LW8M010	Thin Kerf 10"	24	72 44
LW8M010	Thin Kerf 10"	60	89 49
LW9M010	Ultimate 10"	60	128 69
FW10M010	Compnd Miter 10"	60	85 54
F410	Quiet Blade 10"	40	85 49
F810	Quiet Blade 10"	80	135 74
TK306	7-1/4" Finishing	40	38 25
TK906	10" Combo	50	53 32
SD306	8" Dado - Carbide	230	119
SD506	6" Carbide w/case & shims	292	145
SD508	8" carbide w/case & shims	344	164
FB100	16 piece Forstner Bit Set	338	194
94-100	5 pc. Router Bit Door System	320	169
BF3	NEW Router Table	495	289
FJ85	NEW Top Handle Jig Saw	229	125

The following tools have a \$30.00 rebate.
Price shown is before rebate.

Model	Description	List Sale
FT2000E	3-1/4 HP variable speed Plunge Router	410 205
JS102	Biscuit Jointer w/fence & cs	355 179

NEW FREUD Carbide Dado Blades

Model	Description	List Sale
SD608	8" dial-a-width dado	389 199
SD606	6" dial-a-width dado	369 189
SD208	8" economy dado	155 85

WAP VACUUMS

Model	Description	List Sale
766RDF	10 gallon turbo vacuum	845 465
766RDF-D	"Drywaller" 10 gal turbo vacuum	915 549
766RDF-DAS	Above vac w/ auto start	950 589

MAKITA TOOLS

Model	Description	List Sale
6172DWE	3/8" v/spd Drill Kit w/ 2 batt	222 109
5090DW	3-3/8" Saw Kit 9.6 volt	280 146
DA391D	3/8 angle Drill 9.6V	166 109
DA391DW	3/8" angle Drill Kit 9.6V	341 179
ML90	Incandescent Flashlight 9.6V	37

Model	Description	List Sale
6095DWE9	6.0 volt Drill Kit w/2 batt	125 65
6095DWLE2	6095DWE w/flashlight	135 65
6095D	6095DW Drill only & case	Special 47 30
632007-4	9.6 volt Battery	47 30
632002-4	7.2 volt Battery	39 28
5201DWEH	9.6V 3/8" Drill Kit w/2 batt	351 159
6211DWEH	12V 3/8" Drill Kit w/2 batt	368 166
6311DWEH	12V 1/2" Drill Kit w/2 batt	399 205

NEW CORDLESS DRILLS
WITH 2.0 AMP HIGH CAPACITY BATTERIES

Model	Description	List Sale
6213DWAH	12V 3/8" Drill Kit	325 185
6233DWAH	14.4V 3/8" Drill Kit	358 199

SUPER CORDLESS SPECIALS

Model	Description	List Sale
6073DW	7.2v cds Drill Kit, Variable speed & clutch. Complete with battery, charger, & case.	Super Sale 99
T220DW	9.6 volt Stapler Kit. Complete with battery, charger, & case.	Super Sale 99

Model	Description	List Sale
9000B	3"x21" Belt Sander w/bag	347 179
9924DB	3"x24" Belt Sander w/bag	360 189
4301BV	Orb. var. spd Jig Saw 3.5A	292 155
JR3000V	v/spd Recip Saw w/case	264 135
9820-2	Blade Sharpener	433 215
N1900B	3-1/4" Planer with case	263 129
N912B	4-3/8" Planer	352 189
N9514B	4" Disc Grinder 4.5 amp	118 85
DA3000R3/8"	Angle Drill	355 175
2708R	8-1/4" Table Saw	637 309
6405	3/8" Drill Rev. 0-2100 rpm	115 65
6510LVR	3/8" Drill Rev. 0-1050 rpm	188 98
60139R	1/2" Drill Rev. 6 amp	270 145
9401	4" x 24" Belt Sander w/bag	458 219
5007NBK7-1/4"	Circ Saw w/case	250 125
5037NB	NEW 7-1/4" Circular Saw	288 148
LS1011	10" Slide Compound Saw	995 429
LS1211	12" Slide Compound Saw	1620 779
3901	Plate Joiner Kit	376 199
3612C	NEW 3 HP Plunge Router	492 259
LS1040	NEW 10" Compound Miter Saw	460 259

SENCO AIR NAILERS

Model	Description	List Sale
SNF1	Finishing Nailer 1" - 2" w/cs	448 345
SN325	Nailer 1-7/8" - 3-1/4"	665 419
SLP20	Pinner w/cs 5/8 - 1-1/8"	422 275
SKS	Stapler 5/8" - 1-1/2"	390 275
SN70	Framing - Clip Hd 2" - 3-1/2"	725 449
SN60	Framing - Full Hd 2" - 3-1/2"	708 449
SN65	15% more power than SN60709	459
SNF40	Finish Nailer 1-1/4 - 2-1/2"	589 389

BOSTITCH AIR NAILERS

Model	Description	List Sale
N80S-1	Stick Nailer	Super Sale 339
N80C-1	Coil Nailer	Super Sale 339
RN45	Coil Roof Nailer 3/4 - 1-3/4"	845 569
N60FN-2K	Finishing Nailer w/case	557 299
BT35-2	Brad Tacker 5/8" - 1-3/8"	254 155
BT35-2K	BT35-2 w/cse, oil, & brads	279 165
CWC100	1 HP Pancake Compressor	440 289
MIIFS	Flooring Stapler 15 gauge	902 529
S32SX-1	Finish Stapler 1/2" - 1-3/8"	245 155
S32SX-1K	S32SX-1 with case & oil	269 165

SKIL TOOLS

Model	Description	List Sale
77	7-1/4" Worm Drive Saw	Sale 144
77M	NEW 7" Worm Drive Saw	Sale 165

PANASONIC CORDLESS

Model	Description	List Sale
EY6181CRKW	9.6V Drill Kit w/ 2 batteries, 1 hour charger, & case	307 169
EY6100EQKW	12V Drill kit w/ 2 Ironman batteries, 15 min. charger, & case	379 194
EY6100SEOK	Same as above but has 1 Ironman battery and 1 diagnostic battery	Sale 204
EY6101SQK	12 volt 1/2" Drill w/ 15 min. charger, diagnostic battery, & case	436 249
EY6101EQKW	Same as above but has two Ironman batteries	Sale 249
EY3502EQKW	NEW 4-3/8" 12V Metal Cutting Saw Kit	500 289

PASLODE IMPULSE GUNS

Model	Description	List Sale
IM250	Trimpulse Finish Nailer Kit	1130 548
IM325	Impulse Framing Nailer Kit	1130 548
CT325SS	Cds Framing Nailer Kit	1120 495

CLAYTON OSCILLATING SPINDLE SANDERS

Model	Description	List Sale
140	Portable sdr w/ 4-1/2" spindle	625 559
146	Portable sander w/ 9" spindle	685 609
100	Floor mount sdr 4-1/2" spindle	795 709
106	Floor mount sdr 9" spindle	845 759

SIOUX TOOLS

Model	Description	List Sale
8030	3/8" var/spd Drill	263 145
8000	3/8" var/spd close qtr Drill	121 125
690	5" Air Random Orbit Sander	228 132

1997 TOOL CATALOG AVAILABLE
Call Toll-Free 1-800-328-0457 in Minn. Call (612)224-4859
FAX: (612)224-8263
CHECK • MONEY ORDER • VISA • MASTERCARD • DISCOVER
SEVEN CORNERS ACE HDW. Inc.
216 West 7th St. • St. Paul, MN 55102 • Est. 1933

NEW Dewalt 18 volt Cordless Drills

DW995K
1/2" Drill Kit
Sale 229

DW997K
1/2" Drill/Hammer Drill Kit
Sale 249

DW936K
Saw Kit
Sale 249



TOOLS ON SALE
AMERICA'S LOWEST PRICED TOOLS
FREE FREIGHT TO THE 48 CONTINENTAL STATES ON EVERY ITEM
PRICES SUBJECT TO CHANGE WITHOUT NOTICE

DEWALT TOOLS

Model	Description	List Sale
DW321K	NEW Jigsaw Kit	300 164
DW364	7-1/4" Circ. Saw w/bra	294 158
DW610	1-1/2 HP 2 handle Router	266 152
DW411	1/4 sheet Palm Sander	89 58
DW100	3/8" Drill, 4 amp, 0-2500 rpm	118 68
DW682K	Biscuit Joiner with case	448 199
DW705	12" Compound Miter Saw	734 359
DW625	3 HP v/spd Plunge Router	Sale 275

DEWALT CORDLESS DRILLS

Model	Description	List Sale
DW952K	3/8" variable speed w/ two 9.6V XR batteries	284 139
DW962K	23/8" variable speed w/ two 9.6V XR batteries	330 179
DW972K	23/8" variable speed w/ two 12V XR batteries	362 189
DW904	12 volt flashlight	48 29.95
DW927K-2	Drill & DW904 flashlight	Sale 205
DW991K	23/8" variable speed w/ two 14.4V XR batteries	415 225
DW994K	1/2" variable speed w/ one 14.4V XR battery	458 235
DW994K-2	above drill w/ 2 batt.	Sale 259
DW996K	1/2" v/spd/w/ two 14.4 XR batt	245
above drill kits come w/ charger & steel case		
DW991K5-2	DW991K drill, DW935 trim saw, & case	Sale 349

HITACHI TOOLS

Model	Description	List Sale
CFB2	8-1/2" Slide Compound Saw	1169 489
C10FC	10" Miter Saw	533 199
C10FS	10" Slide Compound Saw	1627 739
NR83A	Framing Nailer 2 - 3-1/2" Full Head	900 425
NR83AA	Framing Nailer 2 - 3-1/2"	922 439
NT65A	16 ga. Brad Nailer 1 - 2-1/2	749 325
NV45AB	Coil Roofing Nailer 7/8 - 1-3/4"	935 435
EC6B	1 HP Oil Compressor	540 279
CEC6	1 HP Oil-less Compressor	580 295
CT9B	7-1/4" Circular Saw	Sale 89
FD510DVA	9.6V Drill Kit w/ flashlight	Sale 99

BIESEMEYER FENCES

Model	Description	List Sale
B-50	50" Common Saw	443 325
T-SQUARE 52	52" Homeshop	360 269
T-SQUARE 40	40" Homeshop	335 249
T-SQUARE 28	28" Homeshop	325 239

PONY CLAMP FIXTURES

Model	Description	List Sale
50	3/4" Black Pipe	15.45 8.10 92.50

West Virginia showcases the handmade

Several states actively promote and market the work of their crafts people. Some even have retail outlets for their "Made in (state name)" products.

No state, though, has gone the length that West Virginia has with the opening of its 59,000-square-foot retail crafts and cultural center, called Tamarack. Resulting

Furnituremaker John Wesley Williams designed and built the bird's-eye maple desk and chair to sell at Tamarack, The Best of West Virginia. He is one of the 1,200 juried West Virginia crafts people showing their work.



from a multi-level partnership of state agencies, industries, community leaders, business executives, artisans, and agricultural producers, the center showcases the work of 1,200 juried crafts people of the state. In addition to the retail complex with its 10,000 handmade products, there's a theater, a restaurant, craft studios, sculpture and herb gardens, a gourmet food store, and a festival park. Tamarack will also offer programs and apprenticeships in the crafts.

Planned as a travel destination, Tamarack is adjacent to I-77 in Beckley, a day's drive from major East Coast cities. Call 1-88TAMARACK (304/256-6843 in West Virginia) or Fax 304/256-6877.

The architecture of West Virginia's Tamarack crafts center appears as impressive as the thousands of handmade items for sale inside.



Loggers liked icy roads

In the late 1800s when loggers were clearing northern Wisconsin's pine forests, winter was the time of greatest activity. That's because sled loads of logs—as many as 20 tons at once—

could more easily be pulled by oxen or horse teams on the snowy logging roads. To

make the going even faster, sleds with tanks of water made frequent trips up and down the roads spreading water so that ice would form. But on downhill portions, a "road monkey" or "hayman" had to toss straw under logging sleds' runners to stem their speed.

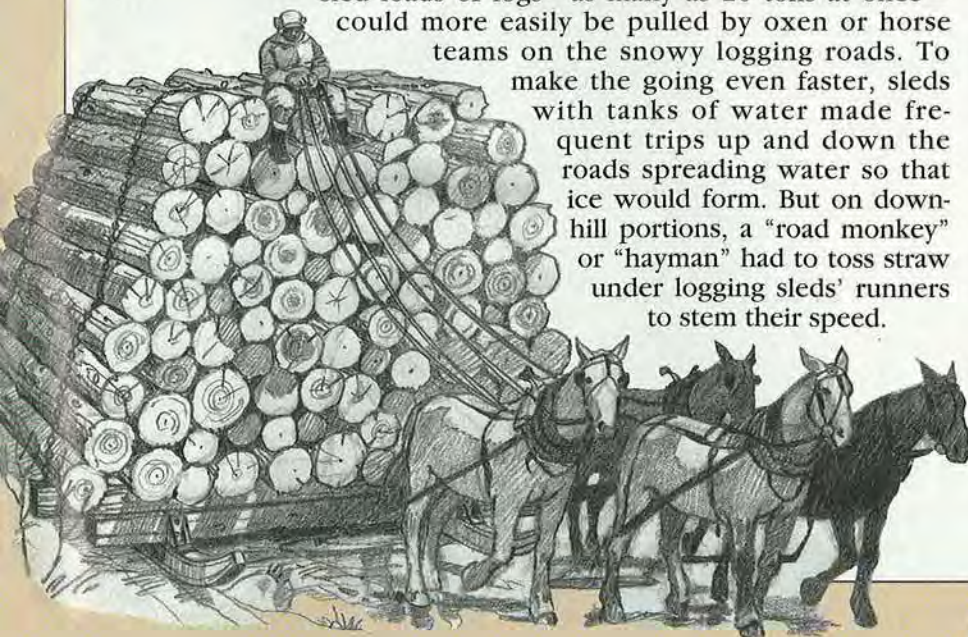

How about hand-friendly hand tools?



Included in Stanley's new line of ergonomically designed hand tools are a measuring tape, handsaw, utility knife, and a hammer.

Ergonomics, the science of fitting the job task to the person doing the work instead of the other way around, is a buzz word in industry today. One possible reason: In 1994 the U.S. Bureau of Labor Statistics tracked 332,100 cases associated with cumulative trauma disorders (CTDs), the injuries that can result from repetitive work tasks. The National Council on Compensation Insurance calculates that the average claim for those injuries was \$12,617.

Stanley Tools jumped aboard the ergonomic bandwagon by introducing a user-friendly Contractor Grade line of hand tools at the National Hardware Show in Chicago last August. They offer more comfortable grips, better control, and in the case of the handsaw, teeth that cut 50 percent faster. You can identify the new ergonomically designed tools by their yellow and gray colors and distinctive packaging, as shown above.

In addition, Stanley has co-published with the National Safety Council a 12-page booklet that explains common cumulative trauma disorders and hand-tool ergonomics. A copy of the publication will cost you \$1 (U.S.). Write to: Introductory Hand Tool Ergonomics, Heggen & Associates, Inc., P.O. Box 5025, Evanston, IL 60204-5025. ☛

Illustration: Jim Stevenson
Photographs: J.W. Farrell; Stanley Tools

If you're in line to buy a new pickup, take a number.

#1 in Available Payload

#1 in Available Towing

#1 in Available Power

#1 in Available Torque

#1 in Interior Room

#1 in Total Quality

Two Years in a Row



¹We calculated resale using avg. trade-in values for '94-'95 full-size models vs. MSRPs, published in Jan. '95-Sept. '96 N.A.D.A. Official Used Car Guide® monthly editions. Use of these values does not constitute NADA's endorsement. ²Won Strategic Vision's 1995 and 1996 Total Quality Award™ in its class. Based on Strategic Vision's 1995 and 1996 Vehicle Experience Studies™ of 31,440 ('95) and 35,652 ('96) Oct.-Nov. new vehicle buyers of 170+ ('95) and 200+ ('96) models after the first 90 days of ownership. ³J.D. Power and Associates 1995 & 1996 Automotive Performance, Execution, and Layout Studies™, based on 27,859 ('95) and 25,492 ('96) consumer responses.



Pickup buyers have to factor in all kinds of considerations. But after you've done your homework, you'll discover that one

pickup meets all your requirements. Dodge Ram.

It can out-tow and out-haul any other pickup around. No surprise there. Dodge offers the single most powerful engine on the market. With more available torque, gas or diesel. It appears you get more of everything in a Dodge Magnum® engine. Plus it has a higher resale value than Ford,



Chevy or GMC.¹ That's not surprising, either. It's won the Total Quality Award™ in its class from Strategic Vision two years in a row.² And it's been ranked the "Most Appealing Full-Size Pickup," by J.D. Power and Associates as well—for the second straight year.³

And you thought buying a new pickup would require a lot of hard choices.

Want to know more? Call 1-800-4-A-DODGE. Or check our Web site at <http://www.4adodge.com>



America's Truck Stop  The New Dodge

JET's rebate

a bright idea!

JWS-18HO
Shaper

\$15

Rebate



DC-1200
Dust Collector

\$20

Rebate

DC-650
Dust Collector

\$15

Rebate



JDP-17MF
Drill Press

\$20

Rebate



JWBS-14CS
Closed Stand
Bandsaw

\$20

Rebate

JWBS-14OS
Open Stand
Bandsaw

\$20

Rebate

JPM-13
Planer/Molder

\$20

Rebate



JJ-6CSX
Jointer

\$20

Rebate

JWP-12
Planer

\$15

Rebate

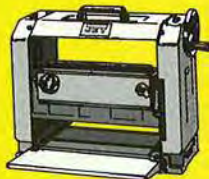

JWCS-10
Cabinet Saw

\$40

Rebate



JWP-15HO
Planer

\$100

Rebate



JWTS-10
Tablesaw

\$20

Rebate

Rebates up to **\$100**

Buy these JET tools today —
and see woodworking
in a whole new light!

Offer effective Oct. 1, 1996
through Feb. 28, 1997.

JET
EQUIPMENT & TOOLS
Auburn, Washington

For the name of your local JET dealer, call 1-800-274-6842 or e-mail to jet@jettools.com • <http://www.jettools.com>

WOOD PATTERNS

FEBRUARY 1997

ISSUE 95

Dear Reader: As a service to you, we've included full-sized patterns on this insert for irregular-shaped and intricate project parts. You can machine all other project parts using the Bill of Materials and the drawings accompanying the project you're building.

COCKATOO BANK Full-sized patterns Page 44

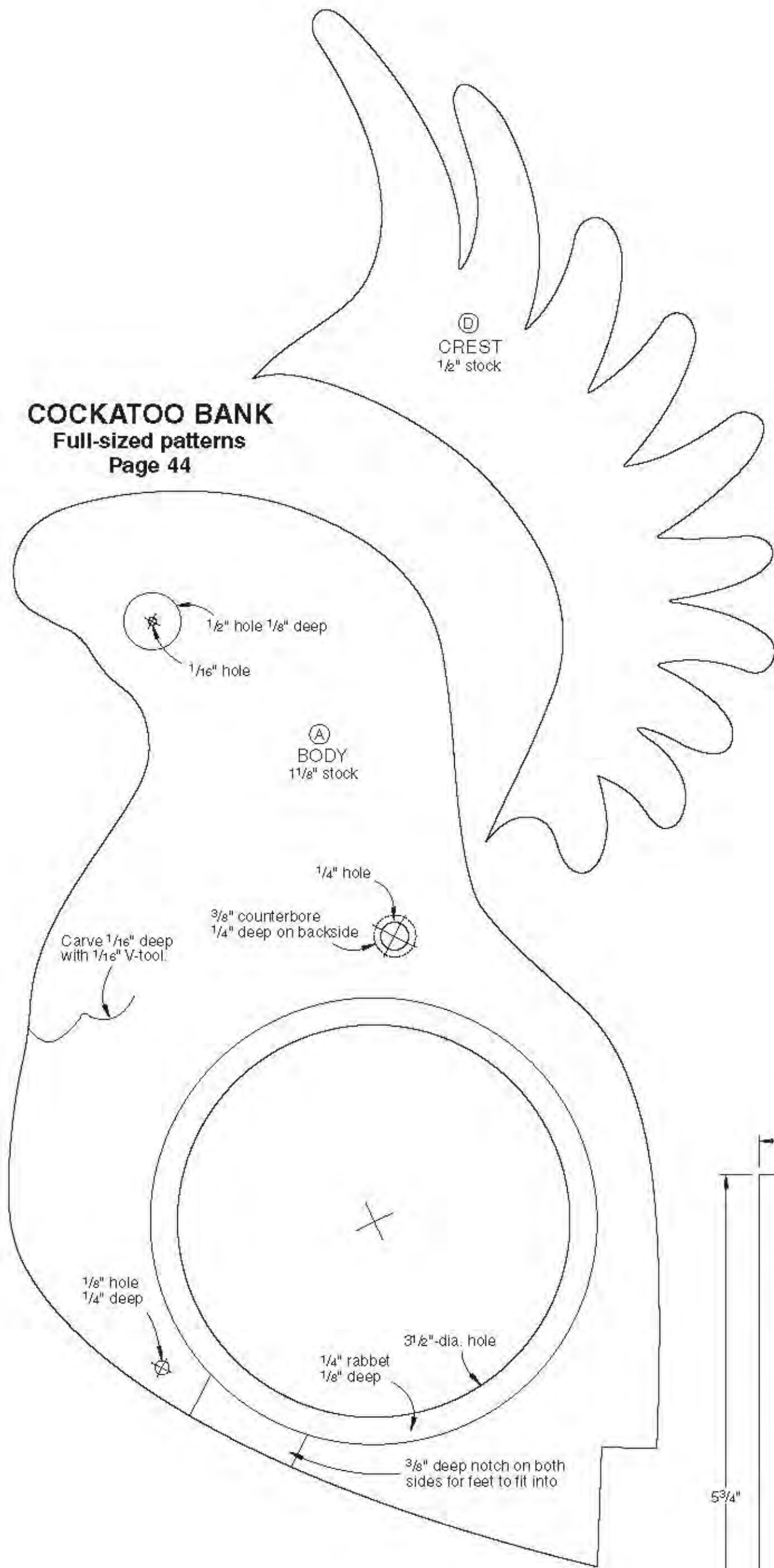

Stupendous Stilts Page 68



Chubby Choo Choo Page 37



Cockatoo Cache Page 44



Arched-top wall shelf Page 50

© Copyright Meredith Corporation, 1996. All rights reserved. Printed in the U.S.A.

TRAIN Full-sized patterns Page 37

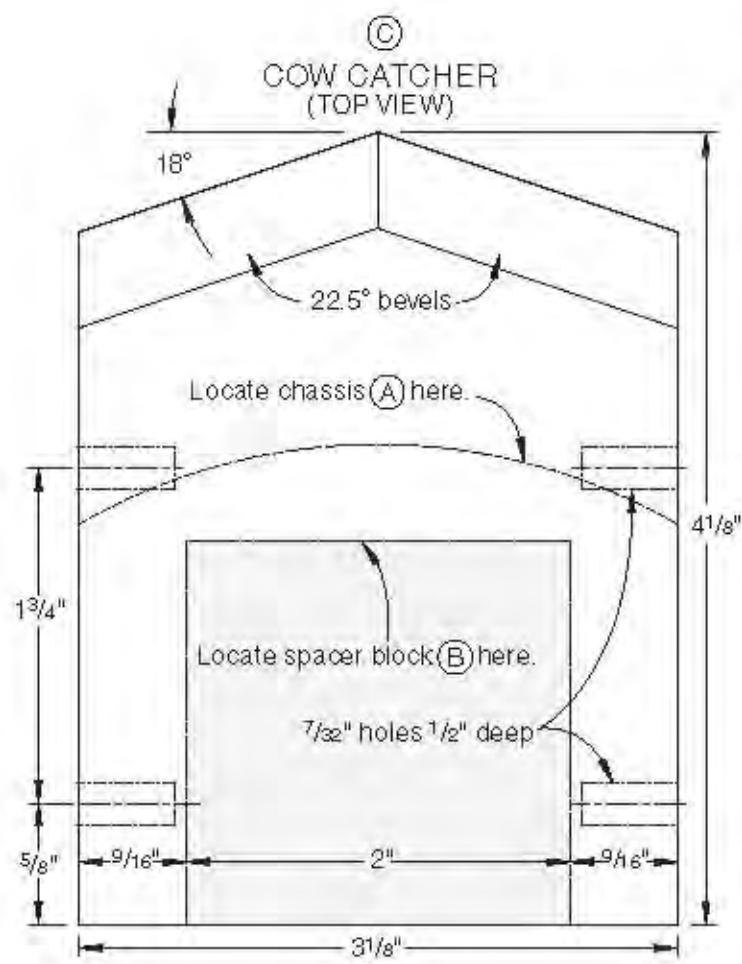
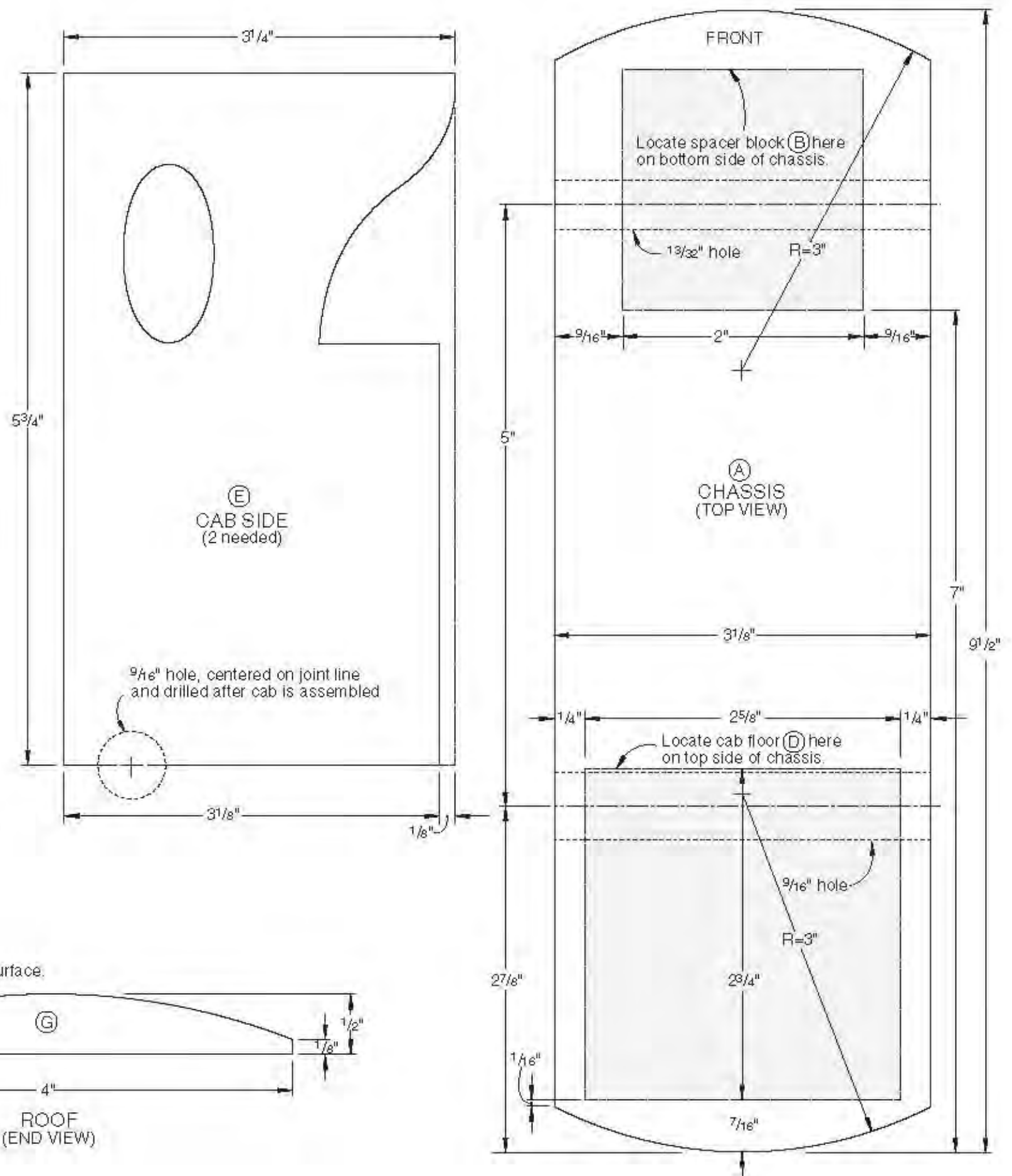

STILTS Part Views (Not shown full sized) Page 68

