

Better Homes and Gardens®

WOOD

INDEX
Projects, tips, techniques
from issues 9 through 16

THE MAGAZINE FOR HOME WOODWORKERS

\$3.50

JUNE 1987 • ISSUE NO. 17

Display until June 16

TEMPLATE ROUTING

2 shop-tested techniques
for routing duplicate
patterns in wood

RADIAL ARM SAWS

Fact-filled buying guide
for these do-it-all saws

SHOP DUST CONTROL

Expert tips help you
design your own central
dust-collecting system

MORE GREAT PROJECTS

Sunburst dining table

Pin routing
attachment

Carving board

Hand-plane rack

So-sweet settee

Drum-sander holder



Take advantage of an old-timer.



(Model 34-782F shown with Unifence™ Saw Guide, accessory Table Board, and Motor Cover.)

Offer good only in the continental U.S., Alaska, and Hawaii, from January 1 to June 30, 1987.

The Unisaw 50th Anniversary Deal.

Right now, Delta is celebrating the Unisaw's 50th Anniversary. So here's your chance to take advantage of the old-time quality and performance that have made our 10" Tilting Arbor Saw the woodworkers' favorite for the past half century.

Find the best deal you can on a 1½, 3, or 5 HP Unisaw. Equip it just the way you want it. You'll get all the advantages of our massive cast-iron table, rugged sealed-for-life bearings, and powerful triple V-belt drive. Advantages that will give you the versatility to do precision ripping, crosscutting, dadoing, moulding, and tenoning.



ative Case—personalized with your name—containing two 10" carbide-tipped saw blades, a 6" carbide-tipped dado set, and a table insert. That's a \$350 value.

And it's yours, free, when you buy a Delta Unisaw. So go ahead. Take advantage of an old-timer. We want you to. Because the old-time quality and value you get in a Delta Unisaw are just too good a deal to pass up. Call toll-free for the name of your Delta distributor. Delta International Machinery Corp., 800/438-2486 (in PA, 800/438-2487).

Here's a good case for buying one.

Then, you can take advantage of us again. In honor of the Unisaw's 50th Anniversary, Delta will send you a special wooden Commemorative Case—personalized with your name—containing two 10" carbide-tipped saw blades, a 6" carbide-tipped dado set, and a table insert. That's a \$350 value.

DELTA
Building On Tradition

The Difference in Value!

Compare Total Shop® with Shopsmith® and see it for yourself!

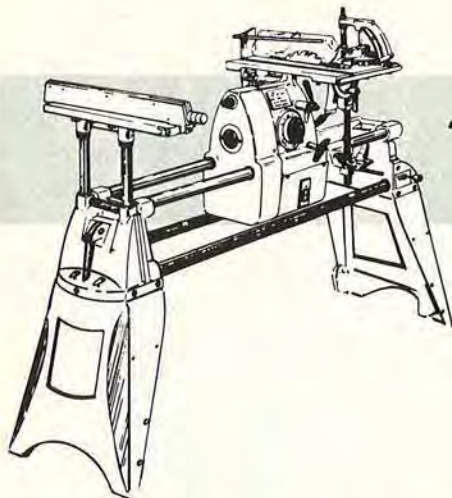

Total Shop®

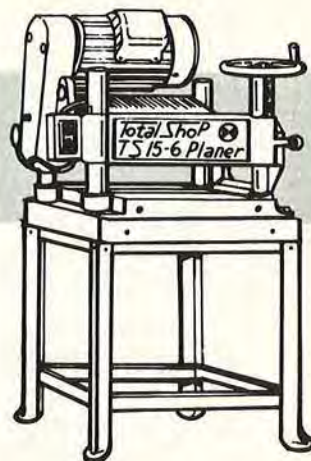

TOTAL SHOP® MULTIPURPOSE MACHINE

If you don't care about quality and superior performance at a lower price you will probably never own a Total Shop® woodworking machine. But those who want more for their money can appreciate the Total Shop difference:

- Total Shop's motor is a full 1½ hp. The Shopsmith® motor is 1⅓ hp.
- Total Shop® is convertible by the owner to 220v, unavailable with Shopsmith.®
- Total Shop® is a much heavier built machine than Shopsmith® weighing over 75 lbs. more.
- In more than 95% of the comparisons, the Shopsmith® machine is priced higher than the Total Shop® machine.

Thousands of Total Shop® owners already know that there is a difference in value.

Call 1-800-845-9356 (or in S.C. 288-4174) and we'll send you 11 more reasons why Total Shop® is the better buy than Shopsmith®

Our 30 minute demonstration video (available in VHS or Beta) will give you a first hand look at the difference in value. Send for it today (with a \$20 refundable deposit).

For all multipurpose tool owners, no matter which machine you own, send for our 2½ hr. instructional video. You'll learn more about the set-up, care and operation of your machine. Order today for only \$49.95 (available in VHS or Beta).

TS15-6 PLANER

Don't overlook the TS15-6 Planer, a rugged machine—convertible to 220V by the owner, optional stand and dust collector available, available with powerful 2HP motor, and a full 15" x 6" board capacity.

A proud addition to any shop. And at a special price while supplies last.

\$795.00

Order today. Supply limited.

YES! Please send me your free information pride packet, with 15 reasons Total Shop is the better buy.

- Multi-purpose tool
 TS 15-6 Planer

YES! Please send me the 30 min. demonstration video, I have enclosed a \$20.00 refundable deposit.

- VHS
 Beta

YES! I have enclosed \$49.95 plus \$2.00 shp. & hdl. for the 2½ hr. instructional video on the set-up, care, and operation of my multi-purpose tool.

- VHS
 Beta

Total Shop®

Dept. Q,
P.O. Box 17859, Greenville, SC 29606

Name _____
Address _____
City _____
State/Zip _____
Phone _____

Call
Toll Free

1-800-845-9356

or in S.C.
288-4174

FREE SANDING BELTS

DIRECT FROM THE MANUFACTURER

GET SIX FREE BELTS FOR EACH DOZEN ORDERED. All belts are aluminum oxide first quality. Our electronic presses make smooth bump-free splices.

Check your size and how many dozen. We will ship assorted grits unless otherwise specified.

- 1" x 30" — \$13.70/doz.
- 1" x 42" — 13.75/doz.
- 1" x 44" — 13.80/doz.
- 3" x 18" — 14.75/doz.
- 3" x 21" — 15.25/doz.
- 3" x 23¼" — 15.70/doz.
- 3" x 24" — 15.75/doz.
- 3" x 27" — 16.25/doz.
- 4" x 21¾" — 17.75/doz.
- 4" x 24" — 18.25/doz.
- 4" x 36" — 21.95/doz.
- 6" x 48" — 27.95/½ doz.(3 FREE)

Other size belts on request.

9" x 11" Paper Sheets

A/O Cabinet Paper		No Load Finishing Paper	
	50/pk.	100/pk.	
40-D	<input type="checkbox"/> \$17/pk.	<input type="checkbox"/> \$31/pk.	180-A <input type="checkbox"/> \$11/pk. <input type="checkbox"/> \$19/pk.
50-D	<input type="checkbox"/> 16/pk.	<input type="checkbox"/> 28/pk.	220-A <input type="checkbox"/> 11/pk. <input type="checkbox"/> 19/pk.
60-D	<input type="checkbox"/> 15/pk.	<input type="checkbox"/> 26/pk.	280-A <input type="checkbox"/> 11/pk. <input type="checkbox"/> 19/pk.
80-D	<input type="checkbox"/> 14/pk.	<input type="checkbox"/> 24/pk.	320-A <input type="checkbox"/> 11/pk. <input type="checkbox"/> 19/pk.
100-C	<input type="checkbox"/> 13/pk.	<input type="checkbox"/> 22/pk.	400-A <input type="checkbox"/> 11/pk. <input type="checkbox"/> 19/pk.
120-C	<input type="checkbox"/> 13/pk.	<input type="checkbox"/> 22/pk.	
150-C	<input type="checkbox"/> 13/pk.	<input type="checkbox"/> 22/pk.	

NEW ITEM!

BELT CLEANING STICK - \$6.95

Wet or Dry S/C Paper

	50/pk.	100/pk.
220-A	<input type="checkbox"/> \$15/pk.	<input type="checkbox"/> \$25/pk.
320-A	<input type="checkbox"/> 15/pk.	<input type="checkbox"/> 25/pk.
400-A	<input type="checkbox"/> 15/pk.	<input type="checkbox"/> 25/pk.
600-A	<input type="checkbox"/> 15/pk.	<input type="checkbox"/> 25/pk.

Prompt delivery from stock.
MONEY-BACK GUARANTEE

Shipping Charges - Under \$35 add \$2.50; \$35 or more add \$4.00—PA residents add 6% sales tax.

Check or Money Order.
 MasterCard VISA Exp. Date _____
 Acct. # _____
 Name _____
 Address _____
 City, State & Zip _____

CALL TOLL FREE
1-800-428-2222

PA Only - 1-800-222-2292

INDUSTRIAL ABRASIVES CO.
643 North Eighth Street
Reading, PA 19603

Better Homes and Gardens® WOOD

THE MAGAZINE FOR HOME WOODWORKERS

June 1987 • Vol. 4, No. 3 • Issue No. 17

Editorial/Art Staff

Editor **LARRY CLAYTON**
 Managing Editor **CHARLES E. SOMMERS**
 Art Director **C. L. GATZKE**
 Design Editor **JAMES R. DOWNING**
 Features Editor **PETER J. STEPHANO**
 How-To Editor **MARLEN KEMMET**
 Buymanship/Techniques Editor **JIM BARRETT**
 Project Builder **JAMES E. BOELLING**
 Graphic Designer **PERRY A. McFARLIN**
 Administrative Assistant **DARLENE REYNOLDS**
 Business Office Clerk **REBECCA REMPE**

Technical Consultants: **GEORGE GRANSETH** Product Testing; **VERNON U. WARD** Collectible Tools; **PAUL L. McCLURE** Wood Technology

Publisher JERRY KAPLAN

New York Advertising Manager **MARK S. HART**
 Promotion/Research Director **THOMAS R. TROLAND**
 Circulation Director **WILLIAM HUMMEL**
 Circulation Manager **BILL REED**
 Production Director **DALE SCHENKELBERG**
 Editorial Research Director **C. RAY DEATON**

Magazine Group Officers

Group President **JAMES A. AUTRY**
 Group Vice Presidents
 Publishing Director **ADOLPH AUERBACHER**
 Editorial Director **DORIS M. EBY**
 Operations **CHRISTOPHER M. LEHMAN**

Corporate Officers

Chairman of the Board **E. T. MEREDITH III**
 President **ROBERT A. BURNETT**
 Executive Vice President—Corporate Services
JACK D. REHM
 Group Presidents: Magazine **JAMES A. AUTRY**; Broadcasting **W. C. McREYNOLDS**; Real Estate **ALLEN L. SABBAG**; Book **FRED STINES**
 Vice Presidents: Corporate Relations **DONALD L. ARNOLD**; General Counsel and Assistant Secretary **THOMAS G. FISHER**; Product Development **NEIL KUEHN**; Corporate Planning **HERB SCHULTE**; Finance **WILLIAM H. STRAW**; Administrative Services **GERALD D. THORNTON**
 Secretary **BETTY CAMPBELL MADDEN**
 Treasurer **MICHAEL A. SELL**
 Controller **LARRY D. HARTSOOK**

Better Homes and Gardens® WOOD — the magazine for home woodworkers (ISSN 0743-894X) is published bimonthly in February, April, June, August, October, and December by Meredith Corporation, 1716 Locust Street, Des Moines, IA 50336. Second-class postage paid at Des Moines, Iowa. Trademark registered in Canada and Australia. Marca Registrada en Mexico. SUBSCRIPTION PRICES: One year \$18 in the United States and its possessions. Canada and other countries add \$6 per year. POSTMASTER: Send address changes to WOOD, 1716 Locust Street, Des Moines, IA 50336. June 1987, Vol. 4, No. 3, Issue No. 17. CUSTOMER SERVICE: For service on your magazine subscriptions, including change of address, write to Customer Service Manager **ROBERT AUSTIN**, P.O. Box 10628, Des Moines, IA 50336. Please enclose your address label from a recent issue. If you wish to phone, call toll-free 800/247-2504.

© COPYRIGHT MEREDITH CORPORATION 1987. ALL RIGHTS RESERVED. PRINTED IN U.S.A.

You've put us on top for 3 generations



With Deft you can finish the finishing in hours, not days. It dries in just 30 minutes, can be recoated in 2 hours, is so easy to use. And when finishing with Deft you can depend on the quality that comes with over 48 years of family ownership.

Deft, Inc.
Irvine, CA 92714-6295
Alliance, OH 44601-0476

HANDS-ON EXPERIENCE REQUIRED.

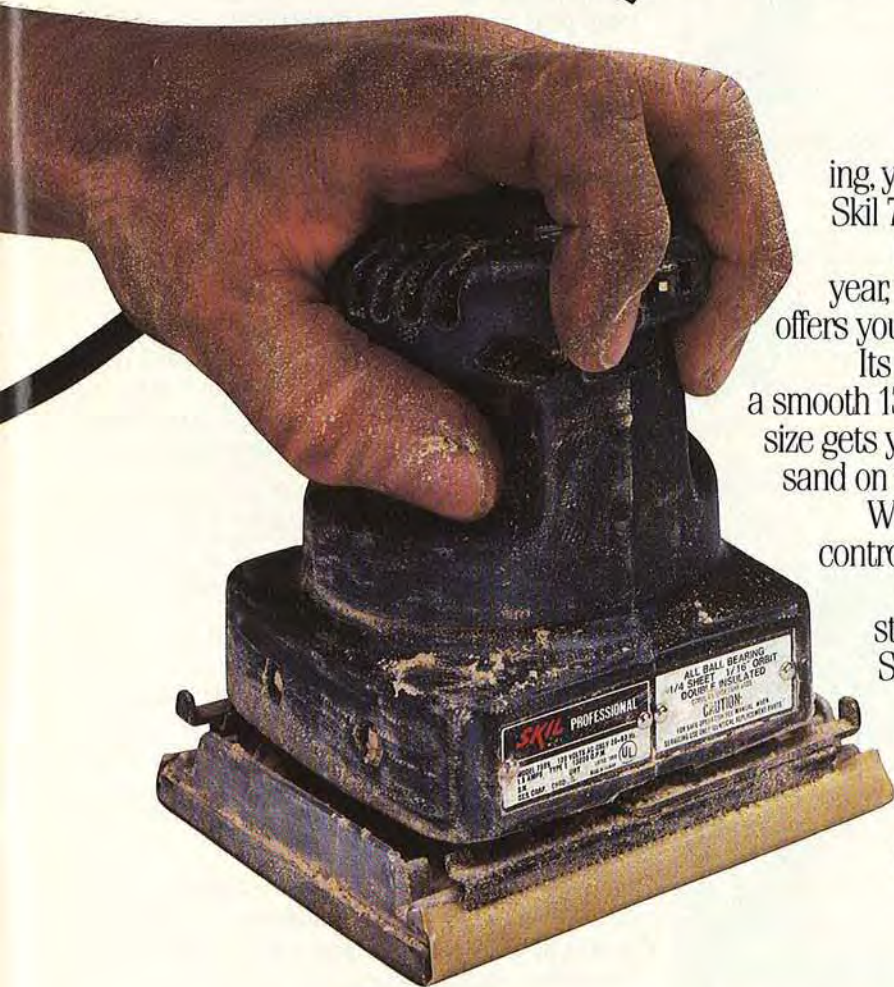

If you've got a talent for fine woodworking, you'll want to get your hands on the new Skil 7565 Professional Palm Grip Sander.

Field tested by professionals for over a year, this high performance finishing sander offers you the perfect balance of power and feel.

Its powerful direct drive motor delivers a smooth 13,000 orbits a minute while its compact size gets you into the tightest corners to flush sand on three sides.

With it, you can do a faster job with more control and less fatigue.

Next time you're at your hardware store or home center ask about the new Skil Pro Line of Professional Power Tools.

If you're more than a beginner, the Skil 7565 Professional Palm Grip Sander is one tool you'll want to finish with.

SKIL[®]

POWER NEVER FELT BETTER



Skil Corporation, Subsidiary of Emerson Electric Co., 4801 West Peterson Avenue, Chicago, IL 60646. © 1987 Skil Corp.

COMB

Authorized Liquidator



20 SCREWDRIVERS Chrome Vanadium Steel Shafts!

For Pros/Do-It-Yourselfers! Add this rugged, heavy-duty 20-Piece Screwdriver Set to your tool arsenal to tackle big or small jobs with confidence. Now you can install or remove virtually any screw-type fastener with ease! This complete set comes to you at a **LOW liquidation price**, due to special arrangements.

- Complete Set Has Chrome Vanadium Hardened Steel Shafts for Many Years of Dependable Service.
- Sure-Grip Molded Handles with Grooved Thumb Rests for Comfort and Turning Power.
- 12 Slotted Screwdrivers: 3/8" x 12", 1/4" x 12", 1/8" x 2", 1/4" x 1", 5/32" x 4", 1/4" x 4", 3/16" x 4", 3/16" x 8", 5/16" x 8", 1/4" x 6", 1/8" x 4" (w/screw holder), 5/16" x 1 3/4".
- 7 Phillips Screwdrivers: No. 0 x 2 1/2", No. 1 x 3", No. 2 x 1 1/2", No. 2 x 4", No. 2 x 8", No. 3 x 6", No. 4 x 8".
- One 4" Reed Prince Screwdriver.

Compare: ~~\$59.00~~ **\$29**
Liquidation
Priced At

Item H-2411-7106-644 Ship, handling: \$4.50/set

\$49
Liquidation
Price For 2 Sets

Item H-2411-7159-478 Ship, hand: \$6.00/two sets



Credit card members can order by phone, 24 hours a day, 7 days a week.

Toll-Free: 1-800-328-0609

Sales outside the 48 contiguous states are subject to special conditions. Please call or write to inquire.

C.O.M.B. Direct Marketing Corp. Item H-2411
1405 Xenium Lane N/Minneapolis, MN 55441-4494

Send 20-Piece Screwdriver Set(s) Item H-2411-7106-644 at \$29 per set, plus \$4.50 per set for ship, handling.
Send TWO 20-Piece Screwdriver Set(s) Item H-2411-7159-478 at \$49 per set of two, plus \$6.00 per set of two for ship, handling.

(Minnesota residents add 6% sales tax. Sorry, no C.O.D. orders.)

PLEASE CHECK: VISA MasterCard DISCOVER AMERICAN EXPRESS

Acct. No. _____ Exp. / _____

PLEASE PRINT CLEARLY

Name _____

Address _____

City _____

State _____ ZIP _____

Phone (____) _____

Sign Here _____

COMB COMB COMB

Better Homes and Gardens®

WOOD

We used Sitka spruce wood grain in cover logotype of this issue.

JUNE 1987

ISSUE NO. 17

WOOD PROFILE

SITKA SPRUCE: THE SOFTWOOD THAT'S STRONG ENOUGH TO FLY 31

Hardy and tall, the "strongman" of softwoods has served mankind in important but unusual ways.



SHOP-TESTED TECHNIQUES

TEMPLATE ROUTING TECHNIQUES 32

Come on, give it a try! We show you two shop-tested routing techniques for duplicating patterns in wood.



DELTA-WING PIN ROUTING ATTACHMENT 38

Ever wonder how those cutting boards and cheese trays with perfectly shaped patterns are made? Wonder no more! With our easy-to-build pin routing attachment and a pattern or two, you can rout all the boards you want.



NOW YOU CAN BUILD IT

STYLIZED MEAT CARVING BOARD 40

Build this great-looking carving board now and have it ready when you do the honors on that next roast, or holiday bird. The Delta-Wing pin routing attachment makes this project a snap to make.



TOOL BUYMANSHIP

RADIAL ARM SAWS — AMAZING VERSATILITY WITHIN ARMS REACH 42

One of these do-it-all saws may be just the tool for you. Here are the options and features to look for, plus a handy buymanship chart.



GOING ALL OUT FOR DUST CONTROL 48

Tired of moving your dust collector from one tool to another? A Minnesota woodworker shows how he solved the problem, and suggests how you can, too.

NOT-SO-PLAIN PLANE RACK 52

Storing your wood planes on a wall rack will help protect your investment and pay off in convenience to boot. Use the plane rack we have in our shop as a guide to build one that suits your needs.



CUMULATIVE INDEX: ISSUES 9 THROUGH 16 53

Looking for a back-issue article? Check our handy, pullout-and-save index. We've compiled all the projects, buymanship advice, techniques, and other topics from these issues.

DRUM-SANDER HOLDER 57

Here's another great shop organizer from the WOOD shop. Let it corral those handy, but often wayward sanding drums and sleeves for you.



SUNBURST DINING TABLE 58

Here we offer you a winning project combination: easy-to-do construction and a beautifully patterned dining table.



HOW THEY MANUFACTURE ROTARY-CUT SOFTWOOD PLYWOOD 64

WOOD visits a plywood mill and shows how modern production keeps softwood plywood strong, versatile, and affordable.

YOU'LL BE SITTIN' PRETTY ON THIS SO-SWEET SETTEE 68

Whether used indoors or out, this durable mortise-and-tenon mahogany bench will serve you admirably.



CRAFTSMAN CLOSE-UP MAKING HIS MARK IN MARQUETRY 74

John Wilson brings a centuries-old wood art form into the 20th Century with a contemporary style.



CARVE FRENCH LOUIE 78

A rustic, backwoods Adirondack mountain hermit — the first in a collection of carving patterns from the nation's top carvers.

SHORT-SUBJECT FEATURES

Talking Back	6	Ask WOOD	82
Shop Tips	16	Make Your Own Hoods	87
Products that Perform	22	Customer Service	98
Bulletin Board	106		

**NOW!
REDUCE THE
RISK AT YOUR
TABLE SAW**



folds down neatly

WITH THE NEW MOBILE™ SAWING CENTER

OUTFEED ROLLERS

- safe, accurate sawing
- handle panels with ease
- available in 15" and 37" widths
- dual-position table

AND INCREASE FLOOR SPACE

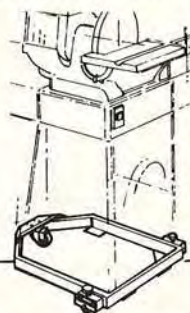

MOBILE MACHINE BASES

- increase shop working area
- maximize usable floor space
- 3 point base will not rock
- locking wheels
- makes machine so easy to use and store
- over 80 standard models

PLANER STAND WITH ROLLERS

- raises planer to proper working height
- provides machine mobility
- five-fold increase in workpiece support
- storage is a snap



NEW



ROLLERTABLE Rock Solid Support

- adjustable
- portable
- use at any machine

PEDESTAL ROLLER

Discover HTC's many unique products designed only with you, the dedicated woodworker in mind. Find out how you can make your machining safer, increase working area of your shop and accomplish nearly impossible tasks easily, quickly and accurately - **all by yourself!**

CALL TODAY!

HTC PRODUCTS, INC.
120 E. HUDSON S-8
ROYAL OAK, MI 48067
(313) 399-8185



1-800-624-2027 ext. 112

We welcome your comments, criticism, suggestions...even an occasional compliment. The volume of mail we receive makes it impossible to answer every letter, but we promise to do our level best. Send your correspondence to:

Letters Editor
 Better Homes and Gardens®
 WOOD Magazine
 Locust at 17th
 Des Moines, IA 50336

MORE FUN WITH FOLK TOYS

I enjoy WOOD magazine, but a couple of your folk toys (WOOD, Dec. 1986, p. 48) had mistakes in some of their dimensions. On "Flap Jack", the dimensions indicated the cross dowel should be 3 7/8" from the top of the uprights, yet in the photo, the dowel appears 3 7/8" from the bottom. Also, the arms on "See Saw" are shown as being

2 3/4" long, which is way too long to work properly.

By the way, the folk toys turned out well, and my grandkids love them.

— Vince Timboli, Sylmar, Calif.

Vince, you're right on both counts. Our artist flipped the uprights over on "Flap Jack" and no one caught it, except you. The cross dowel should be 3 7/8" from the bottom (see drawing at left). And yes, the arms for the men in "See

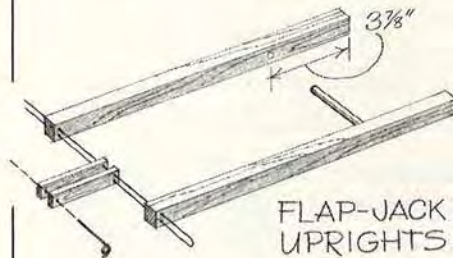

Saw" would be too long at 2 3/4". Try 1 7/8" length instead!

Thanks for alerting us to the errors. Glad though, that all the folk toys turned out alright for the grandchildren. We hope they have many hours of fun with them.

KNOTS HAVE BEAR CLIMBING AGAIN

I made the Climbing Bear from Issue #14, pg. 50. But my two- and three-year old daughters didn't like it. It would hit their knuckles when it came down. To solve this, I tied a second knot six inches up from the first as the new stop for the bear. No more bruised knuckles, and now the bear climbs every day.

— Stephen Cabiroy, Ballston Spa, N.Y.

Your letter proves that even the oldest of folk toys can be improved, Steve. Your addition of the stop knot for Climbing

Continued on page 13

GRIZZLY'S MUCH AWAITED SPRING SALE!



15" PLANER

THE BEST 15" PLANER ON THE MARKET!

(STAND IS OPTIONAL)

15 x 6" capacity, 2 HP, 220 V motor, 3 blade cutterhead, heavy duty cast-iron construction - weighs a hefty 500 lbs.

ONLY \$695.00

FOB WILLIAMSPORT or BELLINGHAM



14" BANDSAW

- 3/4 HP motor
- Fully balanced wheels run on ball-bearings
- Table is precision ground cast iron
- Comes with miter gauge & rip fence
- Weighs 200 lbs.

A REAL GEM!

REGULARLY \$275.00

ONLY \$225.00

FOB WILLIAMSPORT or BELLINGHAM



18" BANDSAW

Comes with 1 1/2" blade, 2 HP motor, miter gauge, rip fence & stand. Wheels are fully balanced. Weighs 500 lbs.

REGULARLY \$595.00

NOW ONLY \$525.00

FOB WILLIAMSPORT or BELLINGHAM



10" HEAVY DUTY TABLESAW

OUR BEST SELLING TABLE SAW

- Precision ground cast iron table & wings are the best in the industry
- 1 1/2 HP motor
- T-slots in table

• Weighs 235 lbs.!

MODEL G1022 - REGULARLY \$325.00

NOW ONLY \$295.00

FOB WILLIAMSPORT or BELLINGHAM



DUST COLLECTORS

These three models have sold extremely well and are an absolute necessity for any shop where sawdust & chips are a problem.

MODEL G1028 — 2 Bags, 1 H.P.
ONLY \$265.00

MODEL G1029 — 2 Bags, 2 H.P.
ONLY \$315.00

MODEL G1030 — 4 Bags, 3 H.P.
ONLY \$425.00

Prices are F.O.B. Bellingham, WA or Williamsport, PA

NOW AVAILABLE AT 2 LOCATIONS:

EAST of the MISSISSIPPI: GRIZZLY IMPORTS PA INC.
 2406 REACH ROAD
 WILLIAMSPORT, PA 17701
 (WILLIAMSPORT BRANCH OPEN) SATURDAYS TILL 1 PM!
 PHONE (717) 326-3806

WEST of the MISSISSIPPI: GRIZZLY IMPORTS INC.
 P.O. BOX 2069
 BELLINGHAM, WA 98227
 PHONE (206) 647-0801



Both warehouses have fully qualified service departments & fully stocked parts departments.

We have dozens of other high quality machines at incredibly low prices

CALL FOR THE BEST CATALOG IN THE INDUSTRY - FREE!

Win one of these famous American Originals.



Grand Prize: A classic, cream-puff 1966 Corvette roadster. The American sports car.

First Prize: America's original vacation cruise. A one-week trip for two aboard the Mississippi Queen Steamboat, including round-trip airfare and \$1,000 spending money.



Ten Second Prizes: \$1,000 worth of selected CooperTools hand tools.



250 Fourth Prizes: Your own original Louisville slugger, with your name branded right into the wood.



50 Third Prizes: A working oak and brass reproduction of the country telephones of the early 1900's.



250 Fifth Prizes: Nothing's so sweet as winning, especially when it's this 5 lb. Hershey bar personalized with your name.

From America's original CooperTools brands.

We've been making America's hand tools since 1848. Not the cheapest tools, but rather the best.

After all these years, that's one thing we're not about to change.

Because that's part of what makes a CooperTools brand an original.

CooperTools

The difference between work and workmanship.

To celebrate our continuing commitment to quality, we invite you to enter the CooperTools American Originals Sweepstakes.



BREWER-TITCHENER® CAMPBELL® COVERT® CRESCENT® LUFKIN® MERRILL® NICHOLSON® PLUMB® TURNER® WELLER® WIRE-WRAP® WISS® XCELITE®

Here's how to enter. No purchase necessary. Visit your participating CooperTools retailer for full details and entry forms or send a self-addressed, stamped #10 envelope to: CooperTools American Originals Request, P.O. Box 4878, Blair, NE 68009. Limit one request per envelope. Requests must be received by 8/10/87. Residents of VT and WA only need not affix postage to their self-addressed envelopes. Sweepstakes open to U.S. residents, 21 years of age or older at time of entry. Void in AK and HI and where prohibited by law. Sweepstakes ends 8/31/87.

Take this giant \$47.90



Work Wonders With Wood...

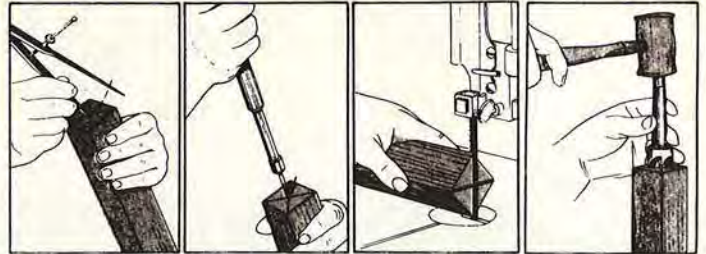

It's easy with master woodworker/craftsman Rosario Capotosto as your step-by-step, start-to-finish guide. Mr. Capotosto is a skilled and prolific how-to writer/photographer who has contributed hundreds of articles to leading do-it-yourself publications. His superb step-by-step photos show you exactly how to create and build exciting new furniture projects and how to do basic and fine woodworking techniques with ease, accuracy, and an original professional touch, even if you're a beginner!

Whether you're a weekend woodworker or a pro in the business, your woodworking success and satisfaction for projects big and small are practically guaranteed with this superb set!

Super-handy and unique, these excellent Capotosto books demonstrate all the basics and fine points you need to know and they introduce scores of innovative woodworking tips and techniques that save you time, materials, and dollars!

You'll gain confidence and learn new skills with these important books. They're loaded with illustrated answers on wood identification, selection, handling...pro tips on wood joinery, sizing, measuring, cutting, matching, filling, finishing...valuable time and money-saving how-to on building, repairing, construction techniques—including dozens of original woodworking project plans you can build and finish yourself!

These fine books also guide you through dozens of POWER TOOL TECHNIQUES you need to know for working with wood on the Saber Saw, Portable Circular Saw, Router, Power Plane, Impact Tool, Table Saw, Radial Arm Saw, Band Saw, Jig Saw, Drill Press, Bench Sander, Sander/Grinder, Jointer, Shaper, Wood Lathe, Grinder, Multi-Purpose Tool...and much more, all illustrated!

You get nearly 50 measured construction plans for building your own tables, chairs, beds, cabinets, lamps, benches, a dry sink, mobile greenhouse, butcher block, tea cart, gateleg table, campaign desk, grandmother clock, rolltop desk, hutch, lounge, candlestand, full-function wall unit and many more!

Yes, this valuable \$47.90 woodworking set—custom-written exclusively for Popular Science Book Club—offers you an enormous range of do-it-yourself woodworking ideas, know-how, and challenge. MORE THAN 3000 ILLUSTRATIONS, PHOTOS, DIAGRAMS (created specifically for these books), show you exactly how to do each technique and project step by step. More than 840 pages of easy-to-follow text instruct you carefully and exactly. Nothing is left out!

As a member of Popular Science Book Club, you get to choose many more books like these. First-rate, top-quality do-it-yourself books that are often hard to find. It's always your choice and you may choose from super-handy Club categories on Home Repair & Improvement, Home Workshops, Basic & Advanced Woodworking, House Building, Remodeling, Insulation, Wiring, Plumbing, Masonry, Electronics, Appliance Repair, Furniture Building, Energy Savers, and much more. You also get first choice of dozens of BOOK BARGAINS offered with each and every selection at discounts up to 75%. To become eligible for these bargains, mail the attached card today. There's no risk!

NO-RISK GUARANTEE—Popular Science Book Club guarantees this no-risk, no-obligation-to-buy offer to examine this \$47.90 WOODWORKING SET in your own home. If not completely satisfied, after ten-day free trial examination, you may return the set at our expense and your membership will be cancelled. Whatever you decide, the BENCHTOP REFERENCE is yours to keep **FREE!** Mail the card today!



FREE when you join

The BENCHTOP REFERENCE gives you instant answers to hundreds of do-it-yourself questions on Woodworking, Joinery, Dowels, Veneers, Laminates, Fasteners, Sharpening, Grinding, even Concrete and Electrical work! 48 big 8 x 10-3/4 pages. ALL ILLUSTRATED! Super-handy and indispensable for every do-it-yourself woodworker!



THOUSANDS OF SEQUENCE PHOTOS SHOW YOU EXACTLY HOW TO DO DOZENS OF WOODWORKING TECHNIQUES AND PROJECTS

WOODWORKING SET

FOR JUST

\$ **3⁹⁵**

with NO-RISK
Free Trial Membership in
Popular Science Book Club

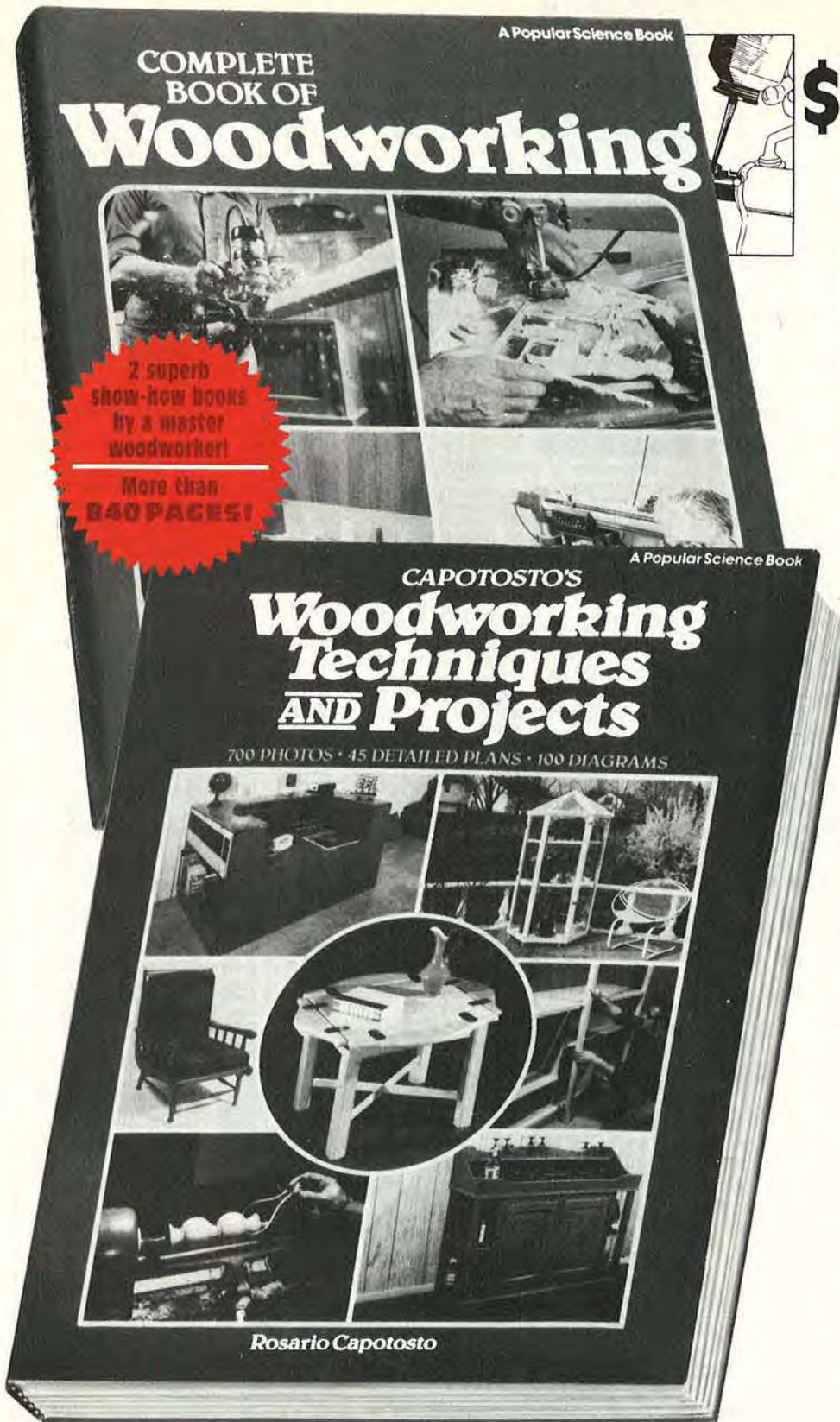

More than
**3000 ORIGINAL ILLUSTRATIONS,
PLANS, SEQUENCE PHOTOGRAPHS**
show you every detail
of project construction
with hand and power tools...
plus every woodworking technique
and procedure you must know!

HOW POPULAR SCIENCE BOOK CLUB WORKS

First, you get your **\$47.90 WOODWORKING SET** along with your **FREE BENCHTOP REFERENCE** for just \$3.95 plus delivery and handling.

Then, about every four weeks (14 times a year) you'll receive a Club Member's bulletin package describing the coming Main Selection and a large selection of Alternate Books also available. In addition, up to 4 times a year, you may receive selected mailings on seasonal and annual products of special interest to the membership, many at giant bargains!

If you want the Main Selection only, do nothing. It will be sent automatically. If you don't want it, or want an Alternate Book, or no books at all, simply indicate your wishes on the handy form that comes with the bulletin and return it to us by the date shown.

You will always have at least ten days in which to do this, but in the unlikely event that you don't and you receive an unwanted selection, you may return it at our expense. After accepting your joining Woodworking Set and free gift, your only obligation is to buy just two more selections of your choice from any category you choose within a year. After that, membership may be cancelled by either you or the Club. That's it!

GIANT DISCOUNTS! Club books are comparable in every way to the original publishers' editions, yet you may save up to 75% and even more on many special book bargains offered throughout the year. To become eligible for these bargains, mail the attached postpaid card today! You'll get today's best way to build a valuable handyman's library of the best, brand new do-it-yourself books that can really save you time, effort, and dollars in the days ahead!

MAIL ATTACHED CARD TODAY!

If card is missing, write to:

Popular Science BOOK CLUB • P.O. Box 2006, Latham, N.Y. 12111

A service of Grolier Book Clubs, Inc.

RYOBI TOOLS

Model	Description	List	Sale
S500A	3x5 1/2 Finish Sander	70	41
SU6200	Finishing Sand. 1/2 Sheet	142	86
B7075	3x21" dustless Belt Sand.	179	116
B7100	3x24" dustless Belt Sand.	208	140
B7200A	4x24" dustless Belt Sand.	269	165
D100V9	3/8" VSR 0-1200 rpm drill	91	49
W640	7 1/4" 13 amp circular saw	158	99
W740	8 1/4" 13 amp circular saw	171	109
J560	Jig Saw-Single Speed	172	99
J5610	Jig Saw-electronic v/speed	198	123
R150	1 H.P. Plunge Router	138	86
R330	2 H.P. Router	220	138
R500	3 H.P. Router	265	163
E3800	Drywall screwdriver 0-4000	126	79
L2100	3/8" Planer	142	89
10120R	3/8" 2-sp Cordless Drill w/free holster-Xtra special buy	148	95
TS251U	10" Mitre Box	300	169
S61150C	4 1/2" H.D. Mini-Grinder	99	59

YOUR ATTENTION PLEASE!
All Above RYOBI TOOL Prices
Take Additional 10% OFF Sale Prices

MILWAUKEE TOOLS

Model	Description	List	Sale
0224-1	3/8 drill 4.5A magnum	173	109
0234-1	1/2 drill 4.5A magnum	173	112
0244-1	1/2 drill 4.5A magnum	173	115
0222-1	3/8 drill 3.3A 0-100 rpm	159	99
0228-1	3/8 drill 3.3A 0-1000 rpm	139	92
0375-1	3/8 close quarter drill	191	118
0210-1	3/8 cordless drill	189	95
6539-1	cordless screwdriver	99	59
1007-1	1/2" drill 4.5A D-Handle	217	145
1107-1	1/2" drill 4.5A D-Handle	222	145
3300-1	magnum rt angle drive kit	271	170
3102-1	Plimbers rt angle drill kit	287	180
1676-1	HD Hole Hwag w/cse 2 sp	363	235
5395	3/8 sgle sp hammer drill kit	203	150
5397	3/8 var sp hammer drill kit	208	155
5371-1	HD mag, hammer drill 1/2"	313	207
5373	HD mag, ham. drill 3/8"	262	175
6511	2 speed Sawzall w/case	197	122
6226	port band saw 2 sp w/case	416	280
6234	TSC band saw port w/case	419	280
6405	8 1/4" circ. saw 13 amp	191	127
6460	10 1/4" 15 amp w/case	380	245
6165	12" Chop saw 15 amp	311	189
6255	v/sp Jig Saw 3.8 amp	217	140
6245	sgle sp Jig Saw 3.8 amp	191	125
6012	1/3 sheet HD Orb. sander	173	110
6014	1/2 sheet HD orb. sander	184	112
5660	1 1/2 HP router 10 amp	289	175
5680	2 HP router 12 amp	342	220

DRYWALL SHOOTERS
6753-1 3.5 amp 0-4000 rpm new 125 79
6747-1 4.5 amp 2500 rpm 157 100
6750-1 4.5 amp 0-4000 rpm 141 90

NEW FROM RYOBI
MODEL AP-10 — 10" Surface Planer
WEIGHS ONLY 58 LBS.
LIST \$59.00 — SALE \$75.00

MILWAUKEE Super Specials!
* BRAND NEW *
Model 0212-1 Cordless
Variable Speed 3/8" Drill
LIST... 209.00 SALE... 125.00
Model 6145 — 4 1/2" Sander-Grinder
LIST... 149.00 SPECIAL SALE... 85.00

Go Cordless with MILWAUKEE
#6305 — 6 1/4" Cordless Circular Saw
12 volt — 1 Hour Charge
Cuts (60) 2x4's (Pine)
List Price 229.00 * SALE PRICE 119.00

FREUD SAW BLADES
Univ. Bore — Professional Series
CARBIDE TIPPED SAWBLADES
Item No. Description Diam. Teeth List Sale
PS203 Gen'l Purp. 7 1/2" 24 27.24 17.50
PS303 Fine cutting 7 1/4" 40 32.97 20.50

3/8" Bore — Industrial Grade
CARBIDE TIPPED SAWBLADES
Item No. Description Diam. Teeth List Sale
LUT7M10 Gen-1 Pump. 10" 40 66.58 34
LUB1M10 Gen-1 Pump. 10" 40 69.30 35
LUT3M10 Cut-Off 10" 60 79.56 36
LUB2M10 Cut-Off 10" 60 86.40 44
LUB4M10 Combination 10" 40 70.99 36
LUB4M11 Combination 10" 50 74.51 37
LUB5M10 Super Cut-Off 10" 80 110.86 62
LMT7M10 Ripping 10" 24 64.85 34
DS 306 6" Dado 139.00 92
DS 308 8" Dado 170.00 105
TR 100 3 blades & Dado set 399.00 255

MAKITA CORDLESS FESTIVAL OF VALUES

Model	Description	List	Sale
4300DW	Jig Saw	158	99
5081DW	3/8" Saw Kit	174	95
5600DW	6 1/4" Circular Saw	224	125
9035DW	Finishing Sander	128	73
6010DWK	3/8" Cordless Drill Kit	152	88
6010SDW	3/8" Cordless Drill	84	45
8400DW	3/8" Hammer Drill	188	105
DA3000DW	3/8" Angle Drill	176	98
6010DL	3/8" Drill w/Flashlight	162	89
6012HDW	3/8" 2 spd Driver Drill	178	98
DK1002	3/8" Drill w/Fluorint Lt	164	90
6710DW	Cordless Screwdrvr Kit	148	84

LEIGH DOVETAIL JIGS

Model	List	Sale
TD514	149	125
TD514L	219	195
D1258-12	299	245
D1258-24	359	275

MAKITA BRAND NEW X-TRA SPECIAL
Model List Sale
5007NBA - 7 1/4" Saw w/Elec. Brake 185 115
5008NBA - 8 1/4" Saw w/Elec. Brake 212 130

MAKITA TOOLS

Model	List	Sale
804510	Sander	86 43
9900B	3" x 21" belt sander	218 119
9924B	3" x 24" belt sander	208 130
9924DB	3" x 24" b/sand. w/bag	234 130
9035	1/3 sheet finish sander	88 48
9045H	1/2 sheet finish sander	184 90
9045S	1/4 sht fin. sand. w/bag	184 105
4200N	4 1/2 circ. saw 7.5 amp	168 93
5008NB	8 1/4 circ. saw 13 amp	198 105
5201NA	10 1/4 circ. saw 12 amp	398 215
4300BVB	v/sp jig saw 3.5 amp	218 120
4301VB	orb v/sp jig saw 3.5 amp	230 125
JR3000WL	2 sp recip saw w/cse	188 120
JR3000V	vs recip saw w/case	198 120

MAKITA TOOLS
SPECIAL PROMOTION
LS1000 New 10" Mitre Box... 368 198
792120-7A Carbide Bld for above... 49 31
9820-2 Blade Sharpener... 268 159
741074-9 60 (coarse) Grdg Whl... 31 23
741077-7 1000 (med) Grdg Whl... 31 22
741071-5 6000 (fine) Grdg Whl... 43 30

BELT SANDERS by PORTER CABLE

Model	List	Sale
#363	4" x 24" w/bag	185
#362	4" x 24" w/bag	198
#295	Sale - 198	
#503	3" x 24" w/bag	150
#510	Sale - 350	

DELTA #34-410 — 10" CONTRACTORS SAW

Model	List	Sale
1100HD	3 1/4" planer w/case	178 92
1100HD	3 1/4" planer w/case	132 160
3608BK	3/4 hp router w/case	132 85
3601B	1 3/8 hp router	198 115
3700B	1/2 hp trimmer	148 82
804530	6" Round Sander	90 48
DA3000	3/8" angle drill	188 105
DP4700	1/2 v/sp w/rev 4.8 amp	172 92
HP1030W	3/8 v.s.r. hammer drill w/case	158 98
6300LR	1/2" angle drill w/rev.	268 152
84198B-2W	1/2" s sp. hammer drill w/case	268 150
GV5000	Disc Sander	98 53
6800DB	2500 rpm 3.5 amp	134 79
6800DBV	0-2500 rpm 3.5 amp	144 89
6801DB	4000 rpm 3.5 amp	134 79
6801DBV	0-4000 rpm 3.5 amp	144 89
2030N	12" planer/jointer	2360 1475
2040	15 5/8" planer	1930 1195
1805B	6 1/8" planer kit w/case	466 265
JV1600	var. speed jig saw	182 89
JV2000	var. speed orb. jig saw	188 100
50059A	5 1/2" circular saw	176 98
9207SPC	7" var/speed electronic sander/polisher	238 130
9303BH	4 1/2" sander-grinder kit	146 95
4014NV	var/speed blower	138 79

DELTA — BRAND NEW
Model List Sale
34-080 10" Mitre Box w/rotary table... 279 179
Repeat of a Sellout
DELTA — SUPER SPECIAL
40-601 18" Electronic v/sp scroll saw — complete 1117 679

WE NOW HAVE A COMPLETE STOCK OF BOSCH CARBIDE TIPPED SHAPER CUTTERS ALL SALE PRICES AT 40% OFF LIST.
buying from Seven Corners Hdw. is a good rule to follow.
Model STANLEY List Sale
33-116 PL-316 3/4" x 16" Rule... 15.95 7.50
33-320 PL-320 3/4" x 20C Rule... 16.95 7.95
33-425 PL-425 1" x 25" Rule... 18.95 8.95
33-430 PL-430 1" x 30" Rule... 20.95 9.95

1987 TOOL CATALOG AVAILABLE
Call Toll-Free 1-800-328-0457 — In Minnesota Call (612) 224-4859
4 WAYS TO BUY: CHECK — MONEY ORDER — VISA — MASTERCARD
SEVEN CORNERS ACE HDW., INC.
216 West 7th St. • St. Paul, MN 55102 • Est. 1933

SAW-ATHON by PORTER CABLE
#314 4 1/2" Trim Saw List 180 SALE 109
#346-1 6 1/2" Top Hdle List 161 SALE 100
#617 7 1/4" Push Hdle List 166 SALE 96
#587 7 1/4" Speedtronic List 199 SALE 125
#315-1 7 1/4" Top Hdle List 166 SALE 96
#368-1 8 1/4" Top Hdle List 176 SALE 110

BELT SANDERS by PORTER CABLE
#363 — 4" x 24" w/bag
List 280 Sale - 185
#362 — 4" x 24" w/bag
List 295 Sale - 198
#503 — 3" x 24" w/bag
List 510 Sale - 350

DELTA #34-410 — 10" CONTRACTORS SAW
w/Stand & 1 1/2 H.P. Motor
SPECIAL PRICE 679.00
FACTORY REBATE... 100.00
FREE DELIVERY TO 48 STATES

TOOLS ON SALE
AMERICA'S LOWEST PRICED TOOLS
*** PLUS — FREE FREIGHT ON EVERY ITEM**

SUPER CORDLESS SPECIALS from BLACK & DECKER

Model	Description	List	Sale
1930	3/8" rev/hi speed	165	110
1950	3/8" High Torque	165	110
5930	Reversible Hammer	179	120
1970	3/8 rev/hi torque screwdrvr	179	120
1980	Rev/hi/clutch Scruddrill	179	120

BRAND NEW! SUPER SPECIALS from MILWAUKEE

Model	List	Sale
0214-1	3/8" c/less drive/drill	189 109
8975	H.D. heat Gun, 11.6A	81 49
5920	Low 570°F - High 1000°F	315 199
5925	belt sander 3x24 w/bag	315 215
5930	belt sander 4x24 w/bag	326 209
5935	belt sander 4x24 w/bag	348 214

PORTER-CABLE — NEW ITEMS +

Model	List	Sale
655	Drywall Driver 0-4000 Rev	115 85
367	3 1/4" Plane 6.5A	170 115
5009	Mortise & Tenon Jig	50 34
351	3" x 21" Belt Sander	189 125
352	3" x 21" Belt Sndr w/bag	199 135
9810	Cordless Screwdrvr kit	175 115
320	Abrazite Plane 3A	129 91

* X-TRA SPECIALS *

Model	List	Sale
100	7/7 H.P. 6.5 amp	141 98
630	1 H.P. 6.8 amp	150 100
690	1 1/2 H.P. 8 amp	194 130
691	1 1/2 H.P. D-Handle 8 amp	218 145
536	1 1/2 H.P. Speedmatic Double Handle	300 190
537	1 1/2 H.P. Speedmatic Double Handle	315 215
520	3 H.P. Production	460 270
518	3 H.P. Microcompressor 5-sp	490 345

TRIMMERS by PORTER-CABLE

Model	List	Sale
309	3.8 amp laminate trimmer	130 90
310	3.8 amp laminate trimmer	190 135
312	offset base laminate trim	205 140
319	tilt-base laminate trim	215 150

MAKITA TOOLS

Model	List	Sale
6010DL	C/less Drill w/flashlight-charger & case	174 90
DP3720	3/8 drill Rev. 0-1800 rpm	98 47
6510LVR	3/8 drill Rev. 0-1500 rpm	136 67
6013BR	1/2" Drill Rev. 6 amp	198 100
5402A	16" Circular Saw-12 amp	518 315
2414	14" Cut Off Saw-13 amp	308 169
3612BR	3 HP Plunge Router	318 175
9401	4x24 belt Sander w/bag	268 160

PORTER-CABLE

Model	List	Sale
696	H.D. Shaper Table	150 105
695	H.D. 1 1/2 hp Router/Shaper	278 190
399	Drywall Cut-Out Unit	100 70
736	V/Sp Speedtronic Band Saw	450 330
7564	1/2" X.H.D. Drill 8 amp	205 145

BOSCH TOOLS

Model	List	Sale
1581VS	Top Handle Jig Saw	225 126
1582VS	Barrel Grip Jig Saw	126 118
1604	1 1/4 H.P. Router	199 118
1942	Heat Gun 650°-900°	99 85
1272	3x24" Belt Sander	259 159
1272D	3x24" Belt Sander w/bag	274 169
1273	4x24" Belt Sander	274 169
1273D	4x24" Belt Sander w/bag	289 179

DELTA

Model	List	Sale
34-010	Motorized Mitre-Box	231 149

* NEW LOW PRICES * PONY CLAMP FIXTURES

Model	List	Sale	of 12
#50	for 3/4" Black Pipe	11.23	7.15 79.00
#52	for 1/2" Black Pipe	9.36	6.10 67.50

JORGENSEN HAND SCREWS

Model	Jaw Length	Open Cap.	List	Sale	Box of 6
#5/0	4"	2"	11.59	7.25	39.15
#4/0	5"	2 1/2"	12.45	8.10	43.75
#3/0	6"	3"	13.36	8.50	45.95
#2/0	7"	3 1/2"	14.36	8.95	48.35
#0	8"	4 1/2"	15.97	9.95	53.75
#1	10"	6"	18.25	11.35	61.25
#2	12"	8 1/2"	20.94	13.60	72.95
#3	14"	10"	26.56	16.75	91.35
#4	16"	12"	34.55	23.75	128.25

TALKING BACK

Continued from page 6

Bear should no doubt help keep a lot more bears climbing, and will be appreciated by many WOOD readers. Thanks for writing and passing on the tip. If anyone else has ideas for improvements, pass them on.

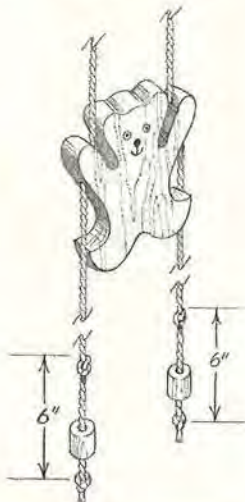

MATHEMATICS WORKING IN THE SHOP

I am a retired high school mathematics teacher. My favorite was geometry, so I enjoyed reading the shop geometry article in *WOOD*, Dec. 1986, pgs. 54-55. It always interests me to see geometric principles applied in practical ways. All too often I see writers present such solutions as a gimmick or bit of magic. But in truth, they work because of the mathematics.

Your method of finding the center of a circle involves the bisection of the diameter or the direct measurement of it. Using a rule graduated in sixteenths to find the radius might be alright in most instances, but not in all. Let me suggest two, more exact methods:

1. Use the procedure as you describe on page 54 but do it twice, laying the framing square in two random positions. The two

diameters will, naturally, intersect at the center.

2. Draw two random chords in the circle. Then construct geometrically, the perpendicular bisect of each cord. They too, will intersect at the center.

— Howard E. Robinson,
Lakewood, Ohio

HELPING SPREAD THE WORD

One of the outstanding things that happened to the Easter Seal Society of Iowa's Homebound Training Program this past year was the article "Lending A Helping Hand" in *WOOD* Magazine (Aug. 1986, pg. 29-31). We have received over 50 letters from all over the United States and Canada inquiring about the program as a result of the article. Many of these letters were from physically disabled men

Continued on page 14

DYNASAND™ DRUM SANDER KITS

In a few hours build a full-capacity sander that can eliminate virtually all hand-sanding on flat work. Get up to 670 square inches in abrasive surface area. Feed-rollers power your work through the sander at a constant rate assuring you of consistent, even results.

The DYNASAND sands with the grain, cross-grains, and end-grains, producing flat, smooth finishes. It sands glued-up work and non-wood materials. Cabinet makers, model-makers, furniture shops, and home hobbyists use this sander to thicken and finish sand re-sawn lumber, raised panels, butcher block and more.



For a brochure and price list contact KUSTER MFG., INC., P.O. Box 34, Skillman, New Jersey 08558. (201) 359-4680.

KUSTER MFG.
MACHINERY & TOOLS

P.O. BOX 34, SKILLMAN, NJ 08558 • (201) 359-4680

MAKE BEAUTIFUL RAISED PANEL DOORS . . . WITH YOUR 1/4" ROUTER!

Professional production quality bit makes it quick and easy to produce matching rails and stiles — the panel raising bit with ball bearing guide makes the raised panel perfect every time.

Regular value Over \$150.00

SALE PRICE **\$69⁹⁵** FOR COMPLETE SET
ORDER ITEM #054 for 1/4" Shank Set
(Includes all bits shown)

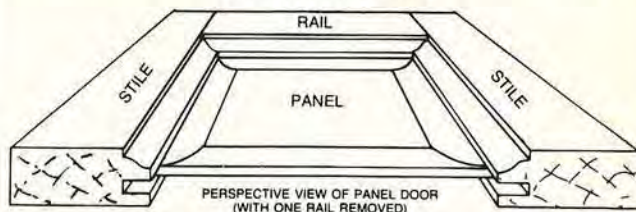

RAISED PANEL BIT
SUPPLIED WITH BALL BEARING

2" Large Diameter

CARBIDE TIPPED
1/4" Shank



REVERSIBLE COMBINATION RAIL and STILE BIT

(For making matching rails and stiles in raised panel doors, etc.)
Works with stock from 1 1/16" to 7/8" thick

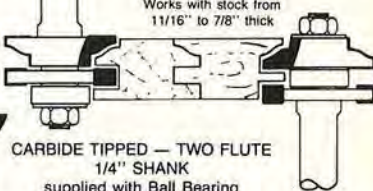

CARBIDE TIPPED — TWO FLUTE
1/4" SHANK
supplied with Ball Bearing

To order by Mastercard or Visa Toll Free
7 Day—24 Hour Order Service, Call
1-800-533-9298 (in PA 1-800-346-7511 Ext. 56)
or send check to: **MLCS, Ltd.**, P.O. Box 53D, Rydal, PA 19046

INTRODUCING



MIFER
tools
USA



With over 50 years of experience Mifer has perfected its chisels and has now received the German Seal of Approval, the industry's highest standard of quality.

Made with special chrome vanadium steel to reduce friction for smoother easier cuts.

Blades engineered perfectly to take a keen edge and hold it longer.

Handles are specially shaped to better fit your hand allowing for precise control and comfort.

Three handle types available:
Solid Oak, Boxwood and Acetate.

Each set comes in its own felt-lined case, box-jointed and fitted to keep your chisels organized and protected.

Unlike many, Mifer Chisels are sharpened and ready to use.

Also available a full line of the finest carving and turning tools.

Mifer chisels available through:

**Woodworker's
Supply**
(OF NEW MEXICO)
5604 Alameda Pl. NE
Albuquerque, NM 87113
505-821-0500 1-800-645-9292

Mifer Tools USA
P.O. Box 5515
Clark, NJ 07066

Dealer Inquiries Welcome

Member of ASEFEC

TALKING BACK

Continued from page 13

wanting encouragement to continue or get started in woodworking. One that stands out in my mind was from a young man in Pennsylvania who had broken his back in a fall while constructing his own home. Others came from professional people working with the disabled. A representative of the Missouri Vocational Rehabilitation Program also visited us as a result of the article.

— Fred J. Kelly, Deputy Executive Director,
The Easter Seal Society of Iowa, Inc.

AND THE ADDRESSES ARE —

I am in the process of buying a new band saw for my shop. Your article on band saws has been a great help. But trying to find the addresses of the manufacturers of the saws that interest me, has been a hassle. It would be a big help if addresses were included in the article.

— Thomas S. Elliott, Collegetown, Penn.

Tom, thanks for the gentle nudge — we do include buyers information in the project building articles but the buymanship articles need them too. In the future, we'll include the manufacturer or distributor addresses when appropriate.

THICKNESSER DOESN'T EQUAL PLANER

I have worked around and with heavy woodworking machinery most of my life. There is no such animal as a thicknesser — there are jointers, planers, and bed planers. Please leave the fancy word coinage to the bureaucrats in Washington.

— E. C. McClellan, Denver, Colo.

It seems rather late, after a 100-plus year history of power tools, to have someone confuse people by inventing new names for standard tools. But except for the faux' pas', I enjoy your publication and rate it a 9.5, on a 1 to 10 scale.

— William Dettmer, Crescent, Ga.

A thicknesser? Hoo boy!

— C. O. Phillips, Canyon, Tex.

Woodworking has been a hobby of mine for the past 32 years. From my point of view, if it saws, I call it a saw...if it drills, I call it a drill...if it sands, I call it a sander...and if it planes, I'm going to keep right on calling it a planer!

— Lucian J. Toussaint, Meadville, Penn.

Judging by some of the mail we received, our use of the term "thicknesser" wasn't very popular with some veteran woodworkers. We appreciate hearing from all who wrote to us concerning the article. ♣

Illustrations: Jim Stevenson

Your workshop can PAY OFF ... BIG!

SAVE... convert low cost rough lumber for use in your home projects

OR

EARN EXTRA INCOME by supplying custom Planed Lumber, trim, and molding to lumberyards... contractors... cabinetmakers... home hobbyists and others...



Try The Foley-Belsaw In Your Own Shop On Our **30-DAY FREE TRIAL OFFER** Mail Coupon Below For Complete Details!

SAWS to desired width...

PLANES to any thickness...

MOLDS Popular Patterns



You can rip, plane and mold... All with Automatic Power Feed!

From the Day It Arrives... the Planer will make and save you money. With shortages and inflation driving lumber prices sky-high, this versatile power tool quickly pays for itself by easily converting low cost rough lumber into high value finished stock. In just one pass turn out your own quarter-round, door and window stop, casing, tongue-and-groove... all popular patterns. Other operators are making cases for grandfather clocks, furniture, picture frames, bee hives, bed slats, surveying stakes... all kinds of millwork.

Built For Pros... Priced For Home Craftsmen... it is engineered and built to industrial standards, but factory-direct selling keeps the price low. Handles tough oak and walnut as easily as pine, and so simple to operate even beginners with no experience can use it.

Start Your Own Business... with just this one low cost power-feed machine in a corner of your garage or basement, you're set up to supply lumberyards, cabinetmakers, carpenters, remodelers, contractors and hobbyists in your area with custom-planed lumber, trim, molding... ALL of their millwork requirements. You can supply picture molding to art shops, hardware and department stores, or sell direct to framing shops. All standard patterns are available from stock, or we'll custom grind a knife to your own special design or sample.

NOW YOU CAN Turn Extra Time Into Extra Income! FOLEY-BELSAW POWER TOOLS

FREE BOOKLET! Get FREE Book with facts and full details... **RUSH COUPON TODAY!**

If coupon has been removed, just send postcard with name and address to:

FOLEY-BELSAW CO.
91072 FIELD BLDG.
KANSAS CITY, MO 64111

**Just Mail Coupon . . .
NO OBLIGATION and
NO SALESMAN Calls!**

ACT NOW!
Coupon Brings Full Details!



FOLEY-BELSAW CO.
91072 FIELD BLDG.
KANSAS CITY, MO 64111

YES, please send me the FREE Booklet that gives me complete facts about your Planer-Molder-Saw and full details on how I can qualify for a 30-Day Free Trial right in my own shop. I understand there is No Obligation and that No Salesman will call.



NAME _____

ADDRESS _____

CITY _____ STATE _____ ZIP _____

In woodworking, as in life, no one knows it all. But through experience, we all discover — or stumble onto — better, safer, faster, or easier ways to do things. When we devise interesting tips or techniques, we'll share them with you in this column. And when you send us your favorites, we'll pay

you \$25 for each submission we publish. No shop tips can be returned. Mail your tips to:

Shop Tips
Better Homes and Gardens®
WOOD Magazine
Locust at 17th
Des Moines, IA 50336

Rx FOR FILLING TINY CAVITIES

Getting glue into tiny hairline cracks can be tough. Sometimes, even a toothpick may not do the trick.

TIP: At your next dental checkup, ask your dentist if he'll part with some of his worn dental probes — the type with a tough, thread-size wire attached to each end of the handle. With them, you can easily and accurately spread glue into extremely narrow cracks.

L.E. Spotts, Slater, Mo.



PRESSED FOR A GOOD CLAMP?

Sometimes you just don't have the right size clamp for clamping odd-shaped projects such as ring bowls and vases.

TIP: Use your drill press. Center the workpiece on your drill-press table. Apply pressure with the quill, using a scrap piece of wood in between to protect the project. Then lock the quill in position. This works well on projects where ordinary clamps aren't deep enough to fit.

E.F. Kubn, Cedar creek, Mo.

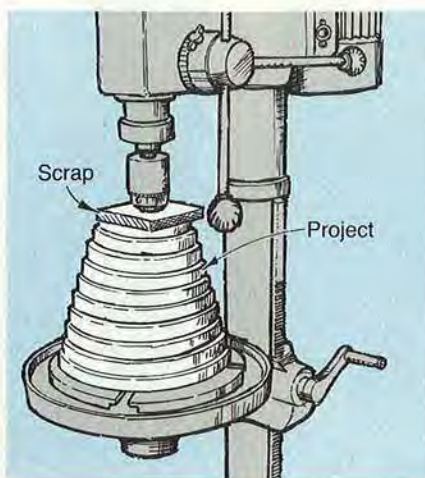

GLASS-SMOOTH CUTS

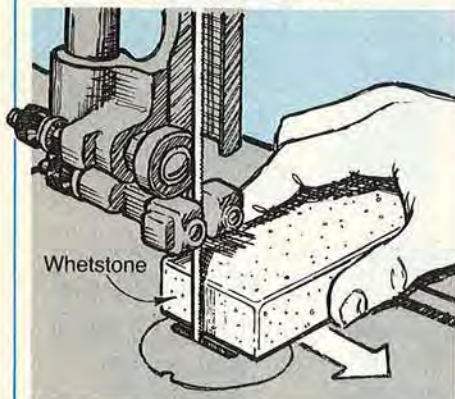

Generally, band saw blades make pretty rough cuts. How can you get smoother cuts?

TIP: This trick works best on $\frac{1}{8}$ " fine-tooth blades, when cutting stock $\frac{3}{4}$ " thick, or less. To get a super-smooth cut, use a coarse whetstone to hone the sides of the blade as shown in the drawing above. This removes the "set" on the teeth. *Note:* After you hone the blade, it will cut slower and won't cut as tight a curve.

From the WOOD shop.

CURE FOR SAWDUST PILE-UP

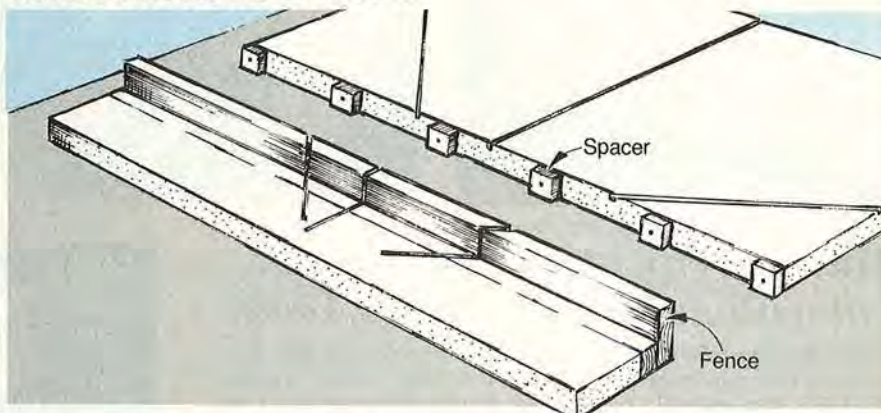

Sawdust piling up against the fence of your radial arm saw table can cause inaccurate cuts. Plus, it's a hassle to stop after every few cuts to brush the dust off the table.

TIP: From a scrap of $\frac{1}{4}$ " birch plywood, cut several spacers 1" long and to a width $\frac{1}{16}$ " less than the thickness of the front table. Attach the spacers to the back edge of the front table with flat head wood screws, aligning the spacer bot-

oms with the bottom edge of the table. This leaves the spacers recessed $\frac{1}{16}$ " below the table surface. Space these 12" apart. Make sure the screw heads are flush with the face of the spacers. Install the fence and back table. Readjust the rip scales on the saw to compensate for the extra $\frac{1}{4}$ " space between the fence and table. Sawdust and chips will fall through the space instead of building up in front of the fence.

Bill Pearce, Jacksonville, Fla.

Continued on page 19

TURN HOME REPAIR PROBLEMS INTO NO PROBLEMS.

WITH ELMER'S®—THE HOME SOLUTION™ PRODUCTS.



If you have a problem in your home that needs gluing, caulking, filling, glazing or spackling, Elmer's has the answer. THE HOME SOLUTION™ line of products. Look for them at your favorite store. © Borden Inc 1987



Problem: How to stop the draft from drafty windows.
 THE HOME SOLUTION™: Elmer's Silicone Caulk. Gives you a long-lasting, flexible seal that insulates and waterproofs.



Problem: How to reglue loose rubber on appliances.
 THE HOME SOLUTION™: Elmer's Stix-All® A strong, high-tech adhesive that bonds just about anything to anything else.



Problem: How to repair a crack in a wall.
 THE HOME SOLUTION™: Elmer's Redi-Spax™ spackling compound. Fast-drying acrylic latex formula stays flexible but sands easily.



Problem: How to patch the deep gouge in the dining room table.
 THE HOME SOLUTION™: Elmer's Carpenter's Wood Filler. Resists shrinking and accepts dark and light stain.



Problem: How to replace caulking around your tub and tile.
 THE HOME SOLUTION™: Elmer's Tub Caulk. Provides a flexible seal that's water and mildew resistant.



Problem: How to protect your hands from paint, oil and grease.
 THE HOME SOLUTION™: Elmer's Invisible Glove™ Protective Hand Cream. Just apply before any dirty job.



Problem: How to replace broken window glass.
 THE HOME SOLUTION™: Elmer's Glaze-Tuff™ glazing compound. It's paintable in only 30 minutes.



Problem: How to attach Formica® to a countertop.
 THE HOME SOLUTION™: Elmer's Contact Cement. Forms a strong bond.



Problem: How to glue the arm back on the armchair.
 THE HOME SOLUTION™: Elmer's Carpenter's Wood Glue. Penetrates wood deeply for a strong bond.



Problem: How to glue protective felt to the bottom of the statue.
 THE HOME SOLUTION™: Elmer's Glue-All.™ It's the ideal all-purpose household glue.

Affordable Quality

in Carbide Dado & Saws from **freud**[®]

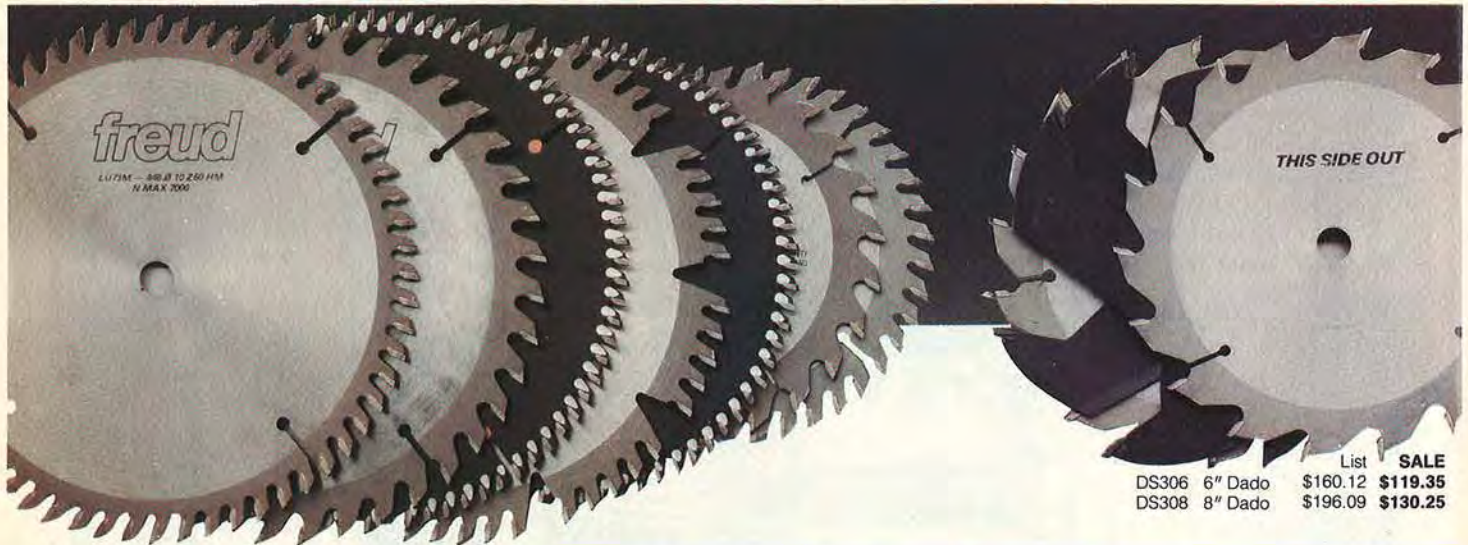

	List	SALE
DS306 6" Dado	\$160.12	\$119.35
DS308 8" Dado	\$196.09	\$130.25

Three Important Features in a Carbide Circular Saw Blade

The Tips: These are made of carbide tungsten and are available in different grades and thickness. Small, softer tips are used by many manufacturers of blades. But Freud uses the hardest grade available, induction brazes it to the saw shoulder and then applies a "glass" edge with a 400 grit diamond wheel. The larger, more durable tips, mean more blade sharpenings and greater blade life for you.

The Plate Body: Milled tool steel will be found in the plate body of the premium blades. At Freud, after the tool steel is milled, it is heat treated and surface ground on both sides. It is then hammered to provide the proper tensioning and then hand checked for trueness. This will ensure that the blade will stretch evenly when run at high speeds.

The Price: Value is a relationship between quality and cost. At Freud, we provide both in an industrial grade product at an affordable price.

**OFFER EXTENDED
THRU JUNE 30, 1987**

Item No.	Glue Joint Ripping	Rip Plywood	Cross Cutting	Plastic Laminated	General Purpose	Diam.	Teeth	List	Your Cost
Straight Line Ripping Hard & Soft Wood	LM72M 008 LM72M 010 LM72M 012	E	G	F	NR	8 10 12	24 24 30	62.11 70.69 93.36	43.59 47.85 54.49
General Cross Cutting	LU73M 008 LU73M 009 LU73M 010	NR	G	G	F	8 9 10	48 54 60	78.10 86.82 86.82	56.65 58.85 48.95
Chip Free Cutting Plastic Laminated	LU78M 008 LU78M 010 LU78M 012 LU78M 014	NR	NR	G	E	8 10 12 14	64 80 96 108	102.10 127.55 153.55 181.23	92.65 90.35 126.39 154.75
Aluminum Cutting	LU80M 008 LU80M 010 LU80M 012 LU80M 014	For Aluminum Cutting Only				8 10 12 14	64 80 96 108	102.10 127.74 156.40 185.34	71.85 90.45 116.59 147.69
Precision Cross Cutting For Wood and Veneers	LU82M 008 LU82M 009 LU82M 010 LU82M 012 LU82M 014	NR	G	G	G	8 9 10 12 14	48 54 60 72 84	85.39 94.18 94.18 134.46 176.02	60.99 66.49 52.25 94.79 120.99
Combination Blade, 4 ATB Teeth & 1 Square Tooth.	LU84M 008 LU84M 009 LU84M 011 LU84M 012 LU84M 014	G	G	G	F	8 9 10 12 14	40 40 50 60 70	77.97 77.38 81.22 122.73 146.34	47.95 47.95 48.49 69.75 105.19
Super Precision Cut Off	LU85M 008 LU85M 009 LU85M 010 LU85M 012 LU85M 014	NR	NR	E	E	8 9 10 12 14	64 72 80 96 108	101.66 111.16 120.86 146.39 162.41	83.39 69.75 80.15 91.55 117.19

E = Excellent G = Good F = Fair NR = Not Recommended

8", 9" and 10" have 5/8" Bore. 12" and 14" saws have 1" Bore.

Call Us Toll Free!

FOR THE NAME OF YOUR LOCAL DISTRIBUTOR:

■ In California
Call Toll Free:
1-800-824-0141

■ If You Live
In This Area:
1-800-824-8045

■ If You Live
In This Area
Call Toll Free
(Outside NC)
1-800-334-4107



freud[®]

218 Feld Ave.
High Point, NC 27264
(919) 434-3171

1570 Corporate Dr., Suite G
Costa Mesa, CA 92626
(714) 751-8866

Continued from page 16

PERFECT PADS FOR FINISH SANDING

Are you having trouble finding just the right kind of sanding pad for finish-sanding contoured shapes?

TIP: We found that foam paint and varnish brushes of various sizes make excellent backing pads for use with fine-grit sandpapers. Remove the handle and wrap the paper around the pad. The thin, flexible pads provide firm backing for uniform sanding, yet allow the paper to follow the contours of the piece you're working on.

From the WOOD Shop



CATCH-ALL FOR OVERHEAD DRILLING

Afraid to look up when drilling overhead with your portable electric drill because you get an eyeful of shavings?

TIP: Slip a Styrofoam or paper cup (cut down to size for short bits) over the drill bit. Pull it back against the chuck so you can see to start the hole. Then push it up and finish drilling the hole. The cup will catch the debris.

Robert G. Fleischman, Verona, Pa.



\$300 to replace. \$10 to repair.

Now there's a wood filler for the big jobs, indoors or out. High Performance Wood Filler by Minwax. It won't shrink, crack or fall out. It hardens in 15 minutes and can be sanded, planed, drilled, painted or stained.

If the wood is soft because of rot, prepare a rock-solid base with High Performance Wood Hardener.

Send today for our free 30-page booklet, *Tips on Wood Finishing*. Minwax Company, Inc., Dept. WO-057 P.O. Box 426, Little Falls, NJ 07424.



High Performance Wood Filler



FREE WHIRLIGIG BOOK



Making Winged Whirligigs is a comprehensive instruction book which will give you all the secrets to making a good whirligig. Plus, two patterns are printed in the book. **AND**, you can get your copy, **FREE**, when you order Timbers' catalog for woodworkers. Timbers' Woodworkers Catalog is your guide to hundreds of woodworking projects. You'll find plans and books for Fanciful Whirligigs, Classic Roadsters and Trucks, Early American Furniture, Patio and Yard Furniture and Decorations, Cozy Birdhouses, Wooden Banks, Planter Pets, Up-to-the-Minute Modern Furniture, All kinds of Clocks, Homemade Woodworking Jigs and Devices, plus much more! Timbers' Woodworking Project catalog is \$1.

For your Catalog and *Making Winged Whirligigs*, mail \$1 to:

Timbers/Lake Tahoe, Inc.
The Timbers Building, Dept. T5
Carnelian Bay, CA 95711-0850

JET

For Only **\$350⁰⁰**

...Jet Metal/Wood Bandsaw...

designed for industrial use but always...“right at home.” You want a bandsaw at an affordable price but with all the features of one costing twice as much. Take a look at JET’s UL Listed wood and metal cutting bandsaw.

The JET 14" bandsaw features a powerful 1 HP, 115/230V, single phase motor. The three step pulley system provides 2 speeds for wood, 1 speed for light metal or plastic. Cast aluminum drive and idler wheels with permanently lubricated ball bearings. A full 6" cutting height and 14" throat depth. A 14", 45° square tilting table. Calibrated mitre gauge. Three way adjustable precision blade guide. Single knob for quick and accurate blade tensioning. Two blades; 1 wood and 1 metal. Removable key safety switch. Totally enclosed metal stand. All this standard for one low price.

Optional equipment available features a bar mounted rip fence and a 6" riser block kit.

With 30 years of experience JET offers top quality, competitively priced woodworking machinery with replacement parts, repair services and technical advice immediately available.

To see this bandsaw contact your local dealer listed or call 1-800-426-8402. Ext. 305.

Quantities are limited at these prices so don't delay.



A
World
Of
Value.

“right at home”

Participating Jet Dealers

ALABAMA

Butler & Co.
128 N. Bellline Hwy.
Mobile, AL 36607
(205) 471-4455

CONNECTICUT

Schneider Hardware Supply Co., Inc.
330 Bank St.
New London, CT 06385-5597
(203) 442-5801

Woodworker's Equipment & Supply
566 Danbury Rd.
New Milford, CT 06776
(203) 354-2219

CALIFORNIA

California Woodworking Machinery Co.
1566 W. Lincoln
Anaheim, CA 92801
(714) 772-2501

The Cutting Edge, Inc. (Los Angeles)
3871 Grandview Blvd.
Los Angeles, CA 90066
(213) 390-9723

The Cutting Edge, Inc. (San Diego)
7550 Miramar Rd.
San Diego, CA 92126
(619) 695-3990

Diablo Power Tool Co.
1820 "A" Arnold Industrial Way
Concord, CA 94520
(415) 685-5400

Diablo Power Tool Co.
2315 Larkspur Ln.
Redding, CA 96002
(916) 221-0285

Sacramento Machinery Co.
3412-A Auburn Blvd.
Sacramento, CA 95821
(916) 483-8513

FLORIDA

Jim & Silms Tool Supply, Inc.
13065 S. Belcher Rd.
Largo, FL 33540
(813) 536-4141

M.B.I. Inc.
12650 49th St. N.
Clearwater, FL 33520
(813) 576-9607

GEORGIA

B.L. Roberson
2459 Brooks Dr. S.W.
Austell, GA 30001
(404) 948-8281

IDAHO

Couer D'Alene Power Tool
451 Cherry Ln.
Couer D'Alene, ID 83814
(208) 667-1158

ILLINOIS

Berland House of Tools
1524 Centre Circle
Downers Grove, IL 60515
(312) 620-0026

Man, Incorporated
801 E. Main St.
Danville, IL 61834-0761
(217) 431-1414

INDIANA

Alco Tool Supply
28235 U.S. 38 West
Elkhart, IN 46515
(219) 295-5535

IOWA

C.W. Crossen Co.
706 E. River Dr.
Davenport, IA 52803
(319) 324-9351

Puckett Electric Tools Inc.
1011 Keo Way
Des Moines, IA 50309
(515) 244-4189

KANSAS

Thornton Company
1707 S. Hoover
Wichita, KS 67209
(316) 942-8474

MAINE

Ben Alpen Co., Inc.
555 Lincoln St.
P.O. Box 1686
Lewiston, ME 04240
(207) 783-2811

MARYLAND

L.A. Benson Co., Inc.
3707 E. Monument St.
Baltimore, MD 21205
(301) 342-9225

Thompson & Cooke, Inc.
4200 Kenilworth Ave.
Bladensburg, MD 20710
(301) 864-6380

MASSACHUSETTS

Robi Tool Sales
160 Broadway
Somerville, MA 02145
(617) 776-1234

Toolhaus Corp.
50 Brook Rd.
Needham, MA 02194
(617) 449-4756

MICHIGAN

Hanks Tool Crib
3172 Enterprises
Saginaw, MI 48603
(517) 791-3098

Power Tools of Michigan
27800 Joy Rd.
Livonian, MI 48150
(313) 421-1620

The Tool Haus
630 N. Silverleaf
Gladwin, MI 48624
1-800-828-0001

The Tool Haus Flint Branch
3320 Brookgate Dr.
Flint, MI 48507
(313) 234-0489

MINNESOTA

G.C. Peterson Machinery Co., Inc.
3815 E. Lake St.
Minneapolis, MN 55406-2296
(612) 721-6661

Northern States Supply
Industrial Park
P.O. Box 1057
Willmar, MN 56201
(612) 235-0555

MISSISSIPPI

Feltus Brother's Hardware Co.
Liberty Rd.
Natchez, MS 39120
(601) 445-4667

MISSOURI

Pyramid Products
1200 Erie St.
N. Kansas City, MO 64118
(816) 421-0890

United Machinery Co.
2315 E. Chestnut Expressway
Springfield, MO 65801
(417) 862-7411

The Wood & Shop
5605 N. Lindbergh Rd.
St. Louis, MO 63042
(314) 731-2761

The Wood & Shop
13202 Tesson Ferry Rd.
St. Louis, MO 63128
(314) 843-5080

W.W. Thayer Co.
7 Capper Dr.
Pacific, MO 63069
(314) 257-4094

NEBRASKA

Pyramid Products North
4544 S. 133rd St.
Omaha, NE 68144
(402) 334-9262

NEW HAMPSHIRE

Brentwood Machine Sales
Rt. 125 @ Scabble Rd.
Brentwood, NH 03833
(603) 679-8452

NEW JERSEY

A.W. Meyer Co.
Broad & Edgewater
Ridgefield, NJ 07657
(201) 945-5500

Hunterdon Mill & Machinery Supply
17 Bloomfield Ave.
Flemington, NJ 08822
(201) 788-5950

King Saw Service
260 Overbrook Ave.
Oakhurst, NJ 07755
(201) 531-0055

Cook Tool & Machine
683 Sicklerville Rd.
P.O. Box 626
Sicklerville, NJ 08081
(609) 629-4900

NEW YORK

Chenango Supply Co., Inc.
142 Susquehanna St.
Binghamton, NY 13902-1910
(607) 772-9595

Culver Atlantic
149 Anderson Ave.
Rochester, NY 14607
(716) 473-8510

SHIELDS SALES CORP.

Port of Albany
Albany, NY 12202
(518) 436-8402

TUNNEL MACHINERY

353 Canal St.
New York, NY 10013
(212) 226-0727

NORTH CAROLINA

Woodworking Machinery & Supplies of Woodcrafts Unlimited
294 Beaty Dr.
Belmont, NC 28012
(704) 827-3190

DIVERSIFIED

11223 Blair Rd.
Charlotte, NC 28212
(704) 545-5198

NORTH DAKOTA

Acme Electric Motor
1705 13th Ave. N.
Grand Forks, ND 58201
(701) 746-6481

Acme Electric Motor
3401 Interstate Blvd.
Fargo, ND 58103
(701) 235-8060

Acme Electric Motor
1009 Basin Ave.
Bismark, ND 58501
(701) 258-1267

Acme Electric Motor
525 - 20th Ave.
Minot, ND 58701
(701) 839-2283

OHIO

Tim Stone Power Tool
142 Union St.
Newark, OH 43055
(614) 344-9404

T-Saw & Tool
1777 Pennsylvania Ave.
Salem, OH 44460
(314) 644-0090

Quality Saw & Tool
328 S. Main St.
Mansfield, OH 44903
(419) 526-4221
(1-800) 523-6927 (Ohio)

OREGON

Barbo Machinery Co.
4617 SE Milwaukie
Portland, OR 97202
(503) 232-8158

Cal-Ore Carbide
2919 N. Pacific Hwy.
Medford, OR 97501
(503) 772-2293

DeBest Tools & Machinery Corp.
1642 NE Sandy Blvd.
Portland, OR 97232
(503) 238-1901

Jerry's Building Material Center, Inc.
2600 Hwy. 99 N.
Eugene, OR 97402
(503) 689-1911

Western Tool Supply
805 S. Burkhardt St.
Albany, OR 97321
(503) 967-4223

Western Tool Supply
1857 25th St. SE
Salem, OR 97302
(503) 588-8222
(1-800) 872-6555 (Oregon)

PENNSYLVANIA

Blue Ball Machine Co., Inc.
3040 - 44 Rt. 322 E.
Blue Ball, PA 17506
(717) 354-4478

Equipment Professionals
101 - 103 W. Susquehanna St.
Allentown, PA 18103
(215) 791-1119

Ideal Tool & Equipment Service
140 N. 10th St.
Philadelphia, PA 19107
(215) 925-0672

Richard T. Byrnes, Co.
600 Hannum Ave.
West Chester, PA 19380
(215) 692-2770

RHODE ISLAND

Gold Industrial Machinery, Inc.
Thurston & Newell Streets
Pawtucket, RI 02860
(401) 724-3200

Kingstown Tool Corp.
3530 Quaker Ln.
N. Kingstown, RI 02852
(401) 295-5472

SOUTH CAROLINA

Cash Supply Co., Inc.
113 Country Club Rd.
P.O. Box 2311
Spartanburg, SC 29304
(803) 585-9326

Mann Electric Repair Co.
3600 Main St.
Columbia, SC 29203
(803) 252-7777

The Tool Shed Inc.
901 Poinsett Hwy.
Greenville, SC 29607
(803) 233-6185

TENNESSEE

Memphis Machinery & Supply
301 S. Front St.
Memphis, TN 38101
(901) 527-4443

TEXAS

Texas Tool Traders
5900 N. Freeway
Houston, TX 77076
(713) 697-9909

Texas Tool Traders
13155 Westheimer
Houston, TX 77077
(713) 496-0811

Texas Tool Traders
2414 S. Jupiter
Garland, TX 75041
(214) 278-0049

Texas Tool Traders
8868 Research #302
Austin, TX 78758
(512) 450-0051

Texas Tool Traders
2215 E. Division
Arlington, TX 76011
(817) 640-9846

Texas Tool Traders
2192 Jackson Keller
San Antonio, TX 78213
(512) 525-1418

VIRGINIA

G.G. Wilkins Co.
12227 Jefferson Ave.
Newport News, VA 23602
(804) 872-7500

Iten Equipment
511A Franklin St.
Martinsville, VA 24112
(703) 956-3904

Nelson Roanoke
901 11th St. N.E.
Roanoke, VA 24030
(703) 982-7575

The Source
7305 Boudinet Dr.
Springfield, VA 22150
(703) 644-5460

Woodworkers Supply
430 Southlake Blvd.
Richmond, VA 23236
(804) 794-0683

VERMONT

Reynolds & Sons
Bridg Street
S. Barre, VT 05670
(802) 479-0101
(In state) (1-800) 642-3109

WASHINGTON

Eastside Saw & Sales
12880 Bel-Red Rd.
Bellevue, WA 98005
(206) 454-7627

L & L Tool Specialties
1927 Hwy. 101 E.
Port Angeles, WA 98362
(206) 457-1116

Spokane Power Tool
E. 801 Trent Ave.
Spokane, WA 99202
(509) 489-4202
(In state) (1-800) 426-0013
(Out of state) (1-800) 521-1700

Tacoma Screw Products, Inc.
2001 Center St.
Tacoma, WA 98409
(206) 572-3444

Tacoma Screw Products, Inc.
2222 Port of Tacoma Rd.
Tacoma, WA 98412
(206) 383-4435

Tacoma Screw Products, Inc.
3930 Leary Way N.W.
Seattle, WA 98107
(206) 632-7565

Tacoma Screw Products, Inc.
607 S. Fidalgo
Seattle, WA 98108
(206) 767-3750

Tacoma Screw Products, Inc.
5241 Auto Center
Bremerton, WA 98312
(206) 479-0230

WISCONSIN

A. Fillinger Inc.
6750 N. 43rd
Milwaukee, WI 53209
(414) 353-8433

G.C. Peterson Machinery Co., Inc.
3125 S. 108th St.
West Allis, WI 53227
(414) 543-5522

Lyle's Sharpening & Supply Co.
1600 A E. 4th St.
Marshfield, WI 53449
(USA) 1-800-624-5395
(WI) 1-800-472-5680

Woodcrafter Wood & Tool Store Inc.
1607 7th St.
Green Bay, WI 54304
(414) 496-0208



"right
at home"

JET

Jet Equipment and Tools
P.O. Box 1477
Tacoma, WA 98401



Some decisions in life are not easy.



14" Wood Cutting Band Saw

Light Duty Wood Shaper

Your choice, \$499 each.

For a limited time, Delta is lowering the price on their 14" Wood Cutting Band Saw and their Light Duty Wood Shaper. So take your choice.

14" Wood Cutting Band Saw

- 6¼" cutting capacity
- 14" x 14" tilting table
- Precision-balanced aluminum wheels
- Equipped with ½ HP motor, lamp attachment, and steel stand

Light Duty Wood Shaper

- Makes mouldings on straight, internal, and external surfaces
- Stable 15½" x 18" table with fully-adjustable fence
- Equipped with 1 HP motor and steel stand

At this price for Delta quality, you might just want to choose both.

Offer good only in the continental U.S. January 1 to June 30, 1987.

- We honor all Freud nationally advertised specials.
- Call or write today for current prices on other tools/accessories.
- Prices quoted, delivered prepaid on \$75 minimum order.
- Visa, MasterCard accepted.

CALL TODAY FOR NEXT DAY DELIVERY.

803-779-3131 Ext. 10



Here at *WOOD*, we're always looking for products that make life in the woodshop a bit easier, or make a project a bit nicer. When you find a product that really works for you, you tell your friends, right? That's the purpose of this column. We don't always feature the newest products on the market, but ones we think you, as a woodworker, will be interested in. And we test all of them to make sure they meet *our* standards of performance: we hope they'll meet your requirements, too.

Quick cosmetic job

We'll admit it — we hate the work of stripping and refinishing old furniture. But this easy-to-use three-step kit removes minor blemishes and restores a permanent shine to dull, worn finishes without refinishing. The manufacturer claims you can use it on any interior finish without changing its color. They do not recommend it for scratched, alligatored, or darkened finishes, but for furniture that "isn't bad enough to need refinishing." We found the system quick and effortless, and the resulting finish comparable to a high-quality varnish. And it doesn't produce the toxic fumes associated with paint and varnish

removers, so you can use it inside your house.

It takes about one hour to apply the cleanser, buffing compound and finish; another two to three hours for the finish to dry. We recommend going easy with the buffing compound — too much buffing may removed the old finish down to bare wood. The main drawback: although the kit contains enough of each solution to do several small

pieces of furniture, you can only use each applicator once, so you have to do all your pieces at one time. *Formby's Furniture Face Lift*, \$15.99 at home centers and hardware stores that carry Formby's products.



Super scraper

If you know how and when to use a wood scraper, you'll like this one.

In the *WOOD* shop, we often use this type of scraper, instead of coarse sandpapers in the wood-smoothing process. We like to use it for smoothing glue joints — especially on edge laminations — that would quickly gum up a sanding belt or sandpaper. It operates on the pull stroke. After scraping, you can go directly to a fine-grit paper for final sanding. The blade has two scraping edges — when one side becomes dull, you simply rotate the blade 180° and use the opposite side. You can sharpen the high-carbon steel blades with a flat file and sharpening stone. We've found that the blades hold a good edge; this scraper gets lots of use in our shop.



We like the comfortable feel of the molded polypropylene handle. It gives you positive, precise control over the blade. Available in 1" to 5" blade widths, with 9" or 12" handles. Sample shown has a 1½" blade. *Hyde Scraper cat. no. 10050; available nationwide through hardware stores and home centers that carry Hyde tools. We paid about \$3.50 for the scraper shown here.*

Continued on page 24

ROUTER BITS

OVER 600
AVAILABLE



•20 Pages •80 Technical Drawings
•1/8 to 3/4" Shank •Carbide & Steel
Send \$3.00 (Dealer Refundable) To:

Dealer
Inquiries
Invited

BYROM INT'L
Dept. BW5 •P.O. Box 246
Chardon, Ohio 44024 U.S.A.

SCROLL SAW LETTERS EASILY...



...with **Lettering Layout Guides!**

- Name Plates
- Signs
- Gifts and more

Our unique Lettering Guides are available in many styles and sizes to suit your needs. Upper and Lower Case Script and Block Styles...and numbers too. Send \$1.00 for brochure and prices to:

SEYCO SALES

2107 So. Garland Ave.
Box 472749
Garland, Texas 75047

PROTECT THOSE FINE EDGES



Powerful ceramic magnetic bar holds fast to all your woodworking tools, even a 15 pound sledge hammer! Great Father's Day gift idea. 24" Chrome Plated Bar, 2 adjustable hanger tabs \$19.95 PLUS SHIPPING CHARGE \$1.50

VISA - MC Call Toll Free 1-800-338-0527

MAGNA PRODUCTS 569 N. MAIN ST. GRAFTON, O. 44044
LIFETIME GUARANTEE
YOUR MONEY BACK IF NOT SATISFIED

WOODWORKERS

Save on Wood - Tools - Supplies!

OVER
4000
ITEMS

Send for
New 1987
148 Page
Money Saving
CATALOG

OUR
57th Year

Dept. K-67, 1735 W. Cortland Ct., Addison, IL 60101
Please enclose \$1.00 to help pay postage and handling.

Finest Dimensioned
HARDWOODS and
Quality **VENEERS**

42 Varieties 1/64" to 4" Thickness
Fast service on choice kiln dried Wood and Veneers, Moldings, Trim, Hand and Power Tools, Lamp Parts, Upholstery Supplies, Clock Movements and Kits, Hard-to-Find Hardware, Finishing Materials, Books ... over 4000 items in stock! Craftsman—Woodworker's best friend.

FREE with Catalog
\$3.00 Discount Coupon
Good on First Order

CRAFTSMAN WOOD SERVICE

WOODWORKING MACHINES 5 in 1 Combination

WITH ELECTRIC MOTOR WHICH
DEVELOPS 3 HP.

- 34" LATHE
- 10" TABLE SAW
- 11 1/2" DISC SANDER
- 16 1/2" VERTICAL DRILL PRESS
- HORIZONTAL DRILL PRESS

NEW MODEL
CENTURY XXI



VERY IMPORTANT

The only machine built with:
A. ALL CAST IRON TABLES
B. HEAVY DUTY DESIGN
C. DEVELOPS 3 HP MOTOR
D. BUILT AS AN INDUSTRIAL MACHINE

ONE PLACE FOR ALL YOUR NEEDS...

Toll Free (1-800) 421-2467

IN CALIFORNIA CALL COLLECT (213) 549-0761

VISA MASTERCARD MONEY ORDER

**MASTER WOODCRAFT
MACHINE CO.**

DEPT. PM, P.O. BOX 669
HARBOR CITY, CA 90710
(A Republic-Lagun Group)

FACTORY DIRECT GRANDFATHER CLOCKS

Do-It-Yourself Clock Kits

Prices
Starting
Under **\$300**

(including movement and dial)

OR
**Completely Assembled
and Finished**

- Solid 3/4" hardwoods: black walnut, cherry, oak
- Heirloom quality
- Solid brass West German chiming movements and dials
- Easy to assemble kits or completely assembled and finished
- Money back guarantee

SEND \$1 FOR
32-PAGE FULL
COLOR CATALOG



**EMPEROR
CLOCK COMPANY**

WORLD'S LARGEST MANUFACTURER
OF GRANDFATHER CLOCKS

Dept. 2305, Emperor Industrial Park
Fairhope, Alabama 36532 • Phone 1-205-928-2316

I am interested in Do-It-Yourself Kits
 Finished Clocks

Name _____
Street _____
City _____
State _____ Zip _____
(please print)

WOODWORKER'S CATALOG



There are
over 3,000
money-saving
reasons why
woodworkers rely on
Constantine.

Unique products. Hard-to-find products. 3,000 woodwork items! Everything important to people who like to Build-Restore-Repair-Refinish—and like to save money doing it. Cabinet or furniture wood? Choose from over 200 sizes and kinds. Beat up surface to cover? Choose from 150 richly-grained veneers. Plus 500 plans...cabinet hardware...96 How-To Books...118 carving tools and chisels...76 inlay designs...and lots more for One-Stop, Right-Price Shopping without leaving home!

116 Page Catalog—Only \$1.00

CONSTANTINE Est. 1812
2054M Eastchester Road, Bronx, NY 10461

HUMFREY'S FOR EXCALIBUR II



**EXCALIBUR II
PRECISION SCROLL SAW**

SHIPPED
UPS PREPAID
SUMMER SALE

\$495. U.S.*

NO OTHER CHARGES
*Electric extra

- 1400, 800 & 400 Strokes/PM
- 19" throat, up to 2" thick
- Accepts all 5" blades
- Table tilts 45° left & right
- Cuts wood, plastics, metals etc.



HUMFREY'S ORDER PHONE
IN THE U.S. CALL TOLL FREE
1-800-387-9789



J. Philip Humfrey International

3241 Kennedy Road, Unit 7 Department WM 3/4
Scarborough, Ontario M1V 2J9 (416) 293-8624
Please rush me details of the EXCALIBUR II Precision Scroll Saw.

OFFER
INCLUDES
72
ASSORTED
BLADE
PKG.

Name _____
Address _____
City _____ State _____ Zip _____

Precision pocket holes made easy

Pocket holes provide a professional touch when using screws to assemble butt joints, post-and-rail joints, and mitered joints. Used in conjunction with your drill press, this adjustable, heavy-duty aluminum guide enables you to make quick, accurate pocket holes in stock up to 1 1/2" thick.

The guide comes complete with a 3/8" countersink drill bit, a Phillips screw-driver bits for use with a variable-speed drill or electric screw-driver, and 24 self-tapping auger-cut screws (these items are also sold separately). It also includes a detailed instruction manual. To use the pocket hole guide, you first attach it to the

drill-press table with a C-clamp. Then you adjust the guide angle according to the thickness of the stock you're drilling.

Generally, we found the guide easy to set up and use. However, we do suggest that you drill a few test holes in a piece of scrap wood the same thickness as the stock you'll be drilling, to make sure you have the guide centered. The bit makes clean holes with minimal tear-out. *Portalign Pocket Hole Guide, \$34.95 at hardware stores and home centers nationwide. Also may be ordered direct from Portalign Tool Corporation, 4909 Pacific Highway, San Diego, CA 92110-4096.*



Throw away the key

These keyless chuck adapter rings come in sizes to fit 1/4", 3/8", and 1/2" drills. Two rubber rings slip over the chuck without any alteration to the drill. To change bits, you twist the rings in opposite directions, or on variable-speed, reversible drills, by holding the front ring and operating the drill at a slow speed in forward or reverse. *Chucklok, \$6.99 at hardware stores and home centers nationwide. Also may be ordered direct from Portalign Tool Corporation, 4909 Pacific Highway, San Diego, CA 92110-4096.*

Continued on page 26

Cascade Precision Tool Co.
Box 848, Mercer Island, WA 98040

PREMIUM QUALITY **S** CARBIDE TIPPED ROUTER BITS AND SHAPER CUTTERS — CUSTOM WORK A SPECIALTY.

40 New Router Bit Profiles!

- Combination 2" O.D. — 1/2"H. (cuts 20 profiles) **\$44.95**
- Palace 1 1/2" O.D. — 1 1/4"H. (3 sizes) **\$39.95**
- Reversible Tongue and Groove **\$35.95**
- Wedge or Straight Tongue **\$30**
- 7/8"-1"-1 1/4" Radius Roundover

1/2" SHANK CARBIDE TIPPED CABINET DOOR SET

- Big 3-1/2" O.D. PANEL RAISER (choice of 5 profiles) Reg. \$59.95 **3 pc. set ONLY \$179.95**
- DRAWER GLUE JOINT **\$39.95**
- CORNER LOCK MITRE 3-3/8" O.D. **\$49.95** For up to 1" material
- RAIL/STILE CUTTER
- RAIL END CUTTER (choice of 4 profiles) Both Reg. \$129.95

CARBIDE TIPPED SHAPER CUTTER PANEL RAISER —

- 3 WING, 5 PROFILES, 3MM THICK CARBIDE
 - 4-5/8" O.D. with 3/4" BORE (1/2" BUSHING)
 - 5-1/2" O.D. with 1-1/4" BORE (1" BUSHING)
- \$69.95**
- 5° FACE CUT 15° FACE CUT CONCAVE 12° FACE & QTR RD CONVEX

CARBIDE TIPPED SHAPER CUTTERS

- HEAVY DUTY SHAPER 3/4" BORE WITH 1/2" BUSHING **from \$29.95**
- 1/2" BORE IN 20 PROFILES — **\$22.00**
- 6-PIECE CABINET SETS 3mm CARBIDE 3/4" BORE WITH 1/2" BUSHING **\$149.95 to \$179.95**
- CORNER LOCK MITRE **\$49.95**

New! \$119.95

- Bex Air Staplers/Nailers w/ 5000 Staples
- 3/4" Spindle Shaper with 1-1/2 H.P. UL Motor **\$359.95**

CATALOG \$1 — FEATURING OVER 200 CARBIDE TIPPED ROUTER BITS AND SHAPER CUTTERS.
ORDER TOLL FREE: 1-(800)-235-0272
IN WASHINGTON STATE CALL 1-206-236-0272
10 AM - 7 PM — Monday through Saturday



IF YOU VALUE YOUR FINGERS..... YOU NEED A RIPSTRATE®

The RIPSTRATE holds the work tight against the fence with no hands near the blade. Makes perfect, straight cuts. Wheels lock to prevent kickbacks. *Requires no adjustment for stock width or thickness.*

Over 20,000 now in use in amateur, professional, school, government, military, and corporate maintenance shops.

One year guarantee, 30 day money back trial. \$69 prepaid. Check, M.O., Visa or M.C. Free Brochure.

Write or call our toll free number: 800-421-0256.

Fisher Hill Products 4 Fisher Hill Fitzwilliam, NH 03447
Dealer inquiries invited.



TOOLCITY

WE HAVE EVERY TOOL YOU NEED

CALL TOLL FREE

INSIDE CALIF 1-800-826-7819

OUTSIDE CALIF 1-800-423-7899



(213) 802-1236 OPEN MON - SAT 8 AM - 5:30 PM

FREIGHT PREPAID (USA) ON ORDERS OF \$50 OR MORE + FREE CATALOG UPON REQUEST WITH \$50 PURCHASE * CALL FOR DISCOUNT FREIGHT RATES FOB SANTA FE SPRINGS

14136 E. FIRESTONE BLVD. SANTA FE SPRINGS, CA. 90670

PHONE NOW AND SAVE UP TO 60% ON:

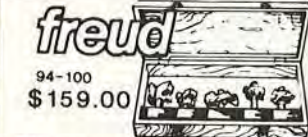

94-100 \$159.00

Plus get a free book on raised panel doors!

	LIST	SALE
90-100 15pc Router bit set	249	126
92-100 26pc Router bit set	489	269
94-100 5pc Cabinet bit set	248	159
EC900 5pc Shaper cabinet set	489	269
FB100 16pc Forstner bit set	249	139
DB050 50pc Drill bit set	89	69
WC106 6pc Chisel Set	47	26
WC110 10pc Chisel Set	80	46
TT108 8pc Turning Set	81	46
CS106 8pc Carving Set	89	54
CS112 12pc Carving Set	167	98



LU72M010 10X40 Gen Purp	75	34
LU73M010 10X60 Cut-Off ATB	87	34
LU82M010 10X60 Cut-Off TCG	95	38
LM72M010 10X24 Ripping	71	34
LU84M010 10X50 Combination	82	37
LU85M010 Fine Cut-off	121	59
LU78M010 10X80 Plastic TCG	128	77
PS203 7 1/4 X24 ATB	30	17
PS303 7 1/4 X40 ATB	36	21
PS403 7 1/4 X40 TCG Teflon	36	25
ADB00 8" Adj. Dado	69	44
DS306 6" Dado Set	169	99
DS308 8" Dado Set	196	109
DS310 10" Dado Set	275	179
99-034 Lockmitre Router Bit	129	79



JS100 Bisquit Joiner	259	179
0-10-20 Bisquits 1000		\$29
CA60PE Barrel Jig Saw	207	139
CA60PEM Top Handle Jig Saw	208	139
LC75 3X21 Belt Sander	207	139
LC110 4X24 Belt Sander	277	189
CEB2 3 1/4" Planer	207	139
LR225 1/2 Sheet Sander	157	99

Call for Other Freud Products for Discounts up to 50%

Milwaukee All Milwaukee Tools & Accessories 30-45% OFF!



	LIST	SALE
APIOC Planer with Dust Chute Attachment. Free Dust Chute Hooks up to any Vacuum!	719	359
R150K 1HP Plunge Router with case & Acces.	179	104
R500 3HP Plunge Router with all Acces.	289	159
R501 3HP Plunge Router with all Acces.	299	169
R330 2HP Router	249	149
TR300 Laminate Trimmer	139	89
T400A Pad sander	59	32.95
SU6200 1/2 Sheet Sander	189	99
TS251U 10" Mire Saw	359	169
TS380 14" Mire Saw	629	369
B7075K 3X21 Belt Sander Kit	209	109
B7100 3X24 Belt Sander	229	119
B7200A 4X24 Belt Sander	279	148



BD10 Cordless Screwdriver	79	38.95
BS50N Resaw Bandsaw	1249	585*
BS360NR Resaw Bandsaw	2099	1150*
AP125 12 1/2" Planer	1999	855*
AH115 Planer-Joiner	2499	1150*
RA2500 10" Radial Arm Saw	619	329*
RA200 8 1/4" Radial Arm Saw	599	248



	LIST	SALE
1100 3" Planer Kit	328	189
1900BW 3 1/4" Planer Kit	198	115
1805B 6" Planer Kit	498	299
2030N Planer-joiner	2580	Call
2040 Planer 15 5/8"	2180	Call
2708W 8 1/4" Table saw w/ carbide blade	396	229
3601B D-Handle Router	218	129
3612BR 3HP Plunge Router	338	199
3700B Laminate Trimmer	162	95
3700DW Cordless Trimmer	162	95
3705 Offset Trimmer	218	159
4014NV V/S Blower	168	109
4200N 4 3/8" Saw	182	109
4300DV Cordless Jigsaw	168	109
4301BV V/S Jig Saw	348	199
5005BA 5 1/2" Saw	102	118
5007NBA 7 1/4" saw elec Brake	194	119
5081DW Cordless Saw	212	119
56000V 6 1/4" Cordless Saw	384	169
6000LR 3/8" Uni-Drill	218	134
6012DV 3/8" Cordless Kit	208	109
6070DV V/S Cordless	108	79
6092DV V/S Cordless	208	124
6801DBV Drywall Screwgun	158	99
9030 1" Belt Sander	224	139
9045A 1/2" sheet sander w/bag	198	109
9900B 3X21 Belt Sander	234	139
9924BD 3X24 Belt Sander	248	139
804510 1/2" Sd Sander	92	48
804530 Round Sander 6"	98	49
DP3720 3/8" V/S Drill	99	49
DP4700 1/2" V/S Drill	118	119
GE0600 1 1/4" Die Grinder	104	79
LS1000 10" Mire Saw	396	219
LS1430 14" Mire Saw	468	289

	LIST	SALE
100 78HP HP router	\$147	\$93
309 Laminate trimmer	135	89
310 Laminate trimmer	190	129
312 Offset Trimmer	205	134
314 4 1/2" panel saw	180	119
315 1 1/2" sander	172	99
319 Tilt base trimmer	221	139
320 Abrasive plane	135	95
330 1/4" sheet pad sander	90	53
351 3X21 Belt Sander	189	126
352 3X21 Belt Sander w/bag	199	130
360 3X24 Belt Sander	260	185
361 3X24 Belt Sander	260	175
362 4X24 Belt Sander w/bag	295	198
503 Wormdrive w/bag 3X24	510	336
504 Wormdrive 3X24	495	326
505 1/2" sheet sander	175	109
518 3HP Sgpd Router	490	322
520 3HP Production Router	460	297
526 1 1/4HP Speedmatic	300	199
631 3/8" VSR Drill	130	84
630 1HP Router	150	94
666 3/8" THDL Drill	165	115
690 1 1/2HP Router w/1/2" Col	194	124
691 1 1/2HP D-Handle Router	218	139
695 Shaper Table w/router	278	190
696 Shaper-router stand	149	104
5008 dovetail jig	85	69
5009 Mortise-tenon Jig	50	34
7511 3/8" VSR Drill	164	114
7514 1/2" VSR Drill	169	119
7533 Adj. Clutch Screwgun	212	149
7545 Drywall Driver	158	109
7548 T-handle V/S jigsaw	200	125
9118 Porta-plane Kit	300	190
9314 4 1/2" panel saw kit	209	139
9548 Bayonet saw kit	255	169
9627 2SPD recip saw kit	193	123
9629 V/S recip saw kit	204	132
9652 Versa plane Kit	200	154
59381 Hinge bolt kit		
Stik-it Sandpaper Disp	22	15

WE SHIP IT FAST

PORTER-CABLE

	LIST	SALE
100 78HP HP router	\$147	\$93
309 Laminate trimmer	135	89
310 Laminate trimmer	190	129
312 Offset Trimmer	205	134
314 4 1/2" panel saw	180	119
315 1 1/2" sander	172	99
319 Tilt base trimmer	221	139
320 Abrasive plane	135	95
330 1/4" sheet pad sander	90	53
351 3X21 Belt Sander	189	126
352 3X21 Belt Sander w/bag	199	130
360 3X24 Belt Sander	260	185
361 3X24 Belt Sander	260	175
362 4X24 Belt Sander w/bag	295	198
503 Wormdrive w/bag 3X24	510	336
504 Wormdrive 3X24	495	326
505 1/2" sheet sander	175	109
518 3HP Sgpd Router	490	322
520 3HP Production Router	460	297
526 1 1/4HP Speedmatic	300	199
631 3/8" VSR Drill	130	84
630 1HP Router	150	94
666 3/8" THDL Drill	165	115
690 1 1/2HP Router w/1/2" Col	194	124
691 1 1/2HP D-Handle Router	218	139
695 Shaper Table w/router	278	190
696 Shaper-router stand	149	104
5008 dovetail jig	85	69
5009 Mortise-tenon Jig	50	34
7511 3/8" VSR Drill	164	114
7514 1/2" VSR Drill	169	119
7533 Adj. Clutch Screwgun	212	149
7545 Drywall Driver	158	109
7548 T-handle V/S jigsaw	200	125
9118 Porta-plane Kit	300	190
9314 4 1/2" panel saw kit	209	139
9548 Bayonet saw kit	255	169
9627 2SPD recip saw kit	193	123
9629 V/S recip saw kit	204	132
9652 Versa plane Kit	200	154
59381 Hinge bolt kit		
Stik-it Sandpaper Disp	22	15

Call for Stik-It Paper!

BOSCH

1609K WITH 3 BASES!	\$169.
---------------------	--------

	LISTSALE
1196VSR 3/8" Hammer Drill	\$165 \$109
1198VSR 1/2" Hammer Drill	199 129
1272 3X24 Belt Sander	264 139
1272D 3X24 Belt Sander w/bag	284 148
1273 4X24 Belt Sander	284 148
1273D 4X24 Belt Sander w/bag	299 158
1286D 1/2" Sheet Sander w/bag	189 108
1581VS T-Handle Jig Saw VS	230 124
1582VS Barley-grip Jig Saw	215 119
160D D-Hdl 2 1/4HP Router	359 239
1601 1 HP Router	184 85
1602 1 1/4HP Router	185 109
1603 D-Hdl 1 1/4HP Router	209 139
1604 1 1/4HP Router	233 149
1606 D-Hdl 1 1/4HP Router	209 144
1608 Laminate Trimmer	129 79
1608T Tilt-base Trimmer	149 99
1609 Offset Trimmer	189 139
1609K Installers Kit w/3 different bases motor & case	269 169
1651 7 1/4" Circular Saw	159 89
1920VSRK 3/8" VSR Cordless drill	169 94
1921VSRK 3/8" VSR Cordless S Driver	199 109
1942 1 1/4 Duty Heat Gun	99 69
3238VS V/S Orbit Jig Saw	139 99
3270D 3X21 Belt Sander w/bag	189 105
11202K Rotary Hammer Kit	599 379
11203K Roto Hmr Kit w/auto stop	639 439
90300 3 1/4 HP Router	500 328
90300 3 1/4 HP Plunge Router	700 448

Call for discount prices on Bosch router bits, jig saw blades and accessories!

OUR GIANT 400 PAGE CATALOG IS YOURS FREE WITH ORDER OF \$50 OR MORE OR ONLY \$2.50 ea.



TR12 3HP Plunge Router w/ Accessories \$310 \$162.50

TR6 1 1/2HP Plunge Router	206	119
TR6 Tilt Base Trimmer	138	83
W6VA VSR Screwgun	133	70
CR10V Orbit recip Saw	224	107
C6DA 6 1/4" Cordless Saw	239	119
SB75 2SPD 3X21 Belt sander	198	139
SB8T 2SPD 3X24 Belt sander	209	149
C10FA 10" DLX Mire Saw	417	269
C15FB 15" DLX Mire Saw	639	425
CJ55VA Orbit Jig Saw	209	139
CB75F Resaw Bandsaw	2420	1449*
P100F 12" Planer	1805	919*
F1000 A-Planer-Joiner	2100	1249*
R100 Dust Collector	782	499



	LIST	SALE
TD514L 12" through Dovetail	149	125
TD51L 24" through Dovetail	218	185
DI258-12 12" 1/2" blind & through	299	245
DI258-24 24" 1/2" blind & through	359	299



	LIST	SALE
28" Homeshop Fence	\$195	
40" Homeshop Fence	209	
52" Homeshop Fence	239	
52" commercial Fence	285	

Phone For Price on made to order fences!



Call For Discount Prices On Senco Guns And Fastners!



Dual Tank Ermaco Comp	\$319
Thomas Pancake Comp	299

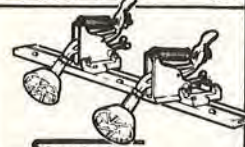

Shophelper Safety Guides	\$69
24" Track w/Gibs	29
Extra pair of brackets	\$10

ALL ORDERS SHIPPED SAME DAY UPS



HTC Tripod roller stand \$39. Call for prices on other HTC products!

	LISTSALE
1000 Dowling Jig	\$44 \$25
2000 Improved Dowl Jig	59 35
7PC Brad point drill set	14

These bits drill a "hole" lot smoother

Drilling the perfect hole can be tough: everything may look OK from the front side as you drill, but what about the back? All too often, when the drill bit breaks through the piece you're drilling, it splits out the wood on the back side, especially in softwoods.

This brad-point drill set, originally manufactured for the furniture industry, leaves the hole walls highly

polished and both sides virtually split-free. The secret's in the design of the carbon steel bits and in matching drill speed to the type of wood you're drilling into. For example, softwoods, such as pine, fir, and spruce, require a fast speed; hardwoods, such as oak, maple, and walnut, need a slower speed.

We got excellent results with these bits — even on softwoods that have a tendency to tear out when drilled. We still suggest clamping the workpiece to a backer board before you start drilling, to minimize what little tearing may occur when the bit breaks through the back side of the hole.

The set includes 12 bits, ranging from 1/8" to 1", in a mahogany case. *Brad-point Drill Set no. MH-20, \$86.00 postpaid from Morris Wood Tool Co., Inc., P.O. Box 249, Dept. W, Morristown, TN 37815.*



Painless finger joints

Finger joints offer exceptional strength and beauty. But without an accurate cutting guide, making them can



be a pain. The Morse Design Accujoint, a template jig used with a dado blade on your table saw, takes the guesswork out of making the repetitive cuts needed for these joints.

To use Accujoint, you first attach a guide board to the saw's miter gauge, then drill a small hole and insert a register pin in the board. The pin guides a 1/8", 1/4", 3/8", or 1/2" template to which you attach the work. Once you've set up the guide, you can quickly make uniformly spaced cuts, one after another. *Morse Design Accujoint, \$41.95 postpaid, Morse Design, Box 195, Boston, MA 02123.*

"An RBI Hawk SS14 makes your Shopsmith® Mark V more versatile, safer, and just plain fun!"

America's number one producer of precision scroll saws now offers the famous RBI Hawk for your Shopsmith® Mark V. Now the accuracy of a constant tension precision scroll saw are yours at a fraction of the cost of an independent machine. Using the power capabilities of your Mark V and the precision of the RBI Hawk you can cut out names, wooden toys, inlays, and virtually end sanding forever!

Send today for your free information on this amazing tool and details on our 30 Day "no risk" guarantee. Don't deny yourself the fun and enjoyment of an RBI Hawk SS14! Quantities are limited at these special introductory prices, act now!

QUALITY AMERICAN MADE TOOLS BUILT FOR WOODWORKERS BY WOODWORKERS



SAVE \$100.00 ON THIS SPECIAL INTRODUCTORY OFFER

Call Toll Free For Faster Service 1-800-535-8665

YES! Please rush me **free** information on the all new RBI Hawk SS14. I understand I am under no obligation.

Name _____
 Address _____
 City _____
 State _____ Zip _____

MAIL TO:
 rbindustries, inc.
 1801 Vine Street
 P.O. Box 369
 Harrisonville, MO 64701

SS03

* SHOPSMITH IS A REGISTERED TRADEMARK OF SHOPSMITH INC.

SUNHILL

SP-101 Cabinet Shop Shaper

- * The most popular model in our complete line of shapers!
- Single phase 2 HP motor
- Precision 1" spindle
- 2 5/8" spindle travel
- 2 reversible speeds
- Options include 3 phase 3 HP motor, 1/2", 3/4" and 1 1/4" spindles; Collets for router bits



List - \$1650 **SALE - \$1075**

TS-10 10" Tilting Arbor Table Saw

- Single or 3 phase 3 HP motor, magnetic switch
- Triple V-belt drive
- 5/8" precision arbor
- T-slot table with mitre gauge
- Milled fence with micro-adjust
- Wt: 485 lbs.
- Sliding table available



List - \$1850 **SALE - \$1260**

SUNHILL

Dept. F
1000 Andover Park E.
Seattle, WA 98188
(206) 575-4131

Introducing Tantung® Tipped Shaper Cutters

From Freeborn . . .
The Innovation Company

Freeborn offers a new generation of super-sharp, super-durable Tantung® Shaper Cutters.

Uniquely designed for cutting natural woods, our Tantung® cutters, which are painted yellow*, provide smoother, higher quality finished cuts that require little or no sanding.

While Freeborn Carbide Tipped Cutters, which are painted orange* are still unsurpassed when working on manmade materials, Tantung® allows Freeborn to offer twice as many stock cutters for a wider range of jobs.

Our Tantung® and Carbide Cutters are available in Mini-Pro and Pro Line specifications.

*The colors yellow and orange are trademarks of Freeborn Tool Company, Inc. Tantung® is a Registered Trademark of Fastest V/Wesson.

Call toll free for the dealer nearest you

1-800-523-8988

In Washington (509) 535-3075



Freeborn Tool Company, Inc.
3355 E. Trent Ave., Spokane, WA 99202

BEAVER TOOL & SUPPLY



9030
Belt Sander
1 1/2" x 21"

\$126



9820-2
Blade Sharpener
Water Cooled

\$158

step up to
makita

CALL OR WRITE FOR CATALOG!

FREE DELIVERY!



BO 4510
Finishing Sander
Hvy. Dty. Lt. Wt.

\$43



6510 LVR
3/8" Drill
Heavy Duty

\$66

BEAVER TOOL & SUPPLY

1599 UNIVERSITY AVE., P.O. BOX 8047,
GREEN BAY, WI 54308

CALL FREE 1-800-992-2877
IN WISCONSIN 1-414-436-6303

A Complete New Combination Kit for Whittling and Carving By WARREN TOOL CO., INC.

BASIC WOODCARVING



In Ten Lessons



Basic Woodcarving lesson book, prepared by the National Carvers Museum, teaches and illustrates proper carving techniques through clear instructions and simple projects.

#COMBI-TCE \$82.00 + \$2.25 p&h
OUR FINEST COMBINATION WHITTLERS AND CARVERS KIT
Contents: 1 Redwood Box, 1-CWH-R Rosewood handle, 1 #L-Palm Walnut handle, (one each) #PTV-1, #LBG, #SBG, #PTV-2, #STC, #STG, #SFTG, #SKU, Gouges, 1-#LD2 (Large Blade), #6SBL (6-Small Blades), 1-Leather Strop Block, 1-Abrasive Paper Block, 1-Instruction Booklet. All blades and gouges sold in their own plastic storage tubes to avoid damage to these honed ready-to-use tools.

WARREN TOOL CO., INC.

Rt. 1, Box 14A-W, Rhinebeck, NY 12572
New Catalog #5 Send \$1 • (914) 876-7817

N.Y. residents add 5.25% sales tax • Foreign shipping: "all foreign orders (including Canada) send MO in US funds plus additional \$1.75 for P&H."



NORTHEASTERN HARDWOODS

RED OAK
WHITE OAK
CHERRY
HARD MAPLE
WALNUT
and other species

COMPARE THE
FINEST QUALITY
AT THE
RIGHT PRICE

TURNING STOCK
PANELING
CURLY AND
BIRDSEYE MAPLE
SPALTED LUMBER
VENEER
CARVING STOCK

FREE CATALOG
WHOLESALE PRICES
NO MINIMUM ORDER

NORTHEASTERN HARDWOODS

P.O. BOX 365 SALAMANCA, N.Y. 14779
716-945-1510

Make Signs?

If you make or are interested in wood signs, you'll want SignCraft — the magazine for the sign artist. You'll see creative wood signs in every issue — carved, routed and sandblasted — plus how to's, pricing, technical help and more! Your satisfaction is guaranteed.

- 1 yr. (6 issues) . . . \$21
- 1 yr. Outside U.S. (U.S. funds) \$27

SignCraft Magazine
P.O. Box 06031-W, Ft. Myers, FL 33906



At Last!
Affordable,
Accurate
Angle
Gauges

The six most commonly used angle cuts 15°—18°—22.5°—30°—45°—60°. Set comes with an attaching bar for setting miter bevel on radial arm saws, bandsaws, drill presses and bench saws. Also can be used on boards cut by hand. A precision cut every time. They are more accurate than a bevel gauge, because they are fixed angles. A must for every shop.

ONLY \$29.95

Please send payment with order. Shipping/handling included.

ROBERT S. SMITH INC., Dept. MJ87
P.O. Box 17330, Phoenix, AZ 85014

Watch for other new products from: Robert S. Smith Inc.
An Innovation Company. Dealer Inquiries Invited.

SQUARE DRIVE SCREWS

Once You Try Them,
You Won't Want to Use Anything Else



- "Cam-Out" is a Thing of the Past
- Heat Treated for Strength
- Thread Optimized for Holding Power

Heavy Duty Plastic Storage Bins

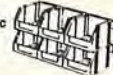

SPECIAL: 100 each of the following sizes, plus a hex driver bit and hand driver. (Plus UPS Shipping)

Size	Length	\$ with Bins	\$ w/o Bins
#6 X 1/2, 5/8, 3/4, 1, 1-1/4, 1-1/2		\$16.54	\$12.29
#8 X 3/4, 1, 1-1/4, 1-1/2, 2, 2-1/2		19.47	15.72
#10 X 1-1/4, 1-3/4, 2, 2-1/4, 2-1/2, 3		27.49	22.94

Square Drive Screws also available in Solid Brass, Zinc Plated and Round Washer Head (similar to Pan head). Call or write for pricing.



McFEELY

Hardwoods and Lumber



P.O. Box 3 • 43 Cabell St • Lynchburg, Va. 24505
1-804-846-2729 • In Va. 1-800-542-2023

BE A LOCKSMITH EARN MORE—LIVE BETTER

The ever-growing field of Locksmithing offers you unlimited opportunities for good paying jobs or big profits in your own business. It's easy. Do real jobs—earn while you learn. Tools and Materials Supplied. State of N. J. Approved. Free booklet. "Opportunities in Locksmithing". No salesman will call.

**TRAIN AT HOME—
EARN EXTRA \$\$\$ RIGHT AWAY!**

LOCKSMITHING INSTITUTE
Div. Commercial Technical Institute
1500 Cardinal Drive, Dept. 183-067
Little Falls, N.J. 07424

Name _____

Address _____

City/State/Zip _____

**the
Fine
Tool
Shops
INC.**

NEW! FROM THE FINE TOOL SHOPS



LARGE FORSTNER BITS

The saw tooth edges reduce heat build-up. The cutting efficiency is the same as with the knife edge bits. These 1/2" shank large bits are up to 7" long and are designed for drill press use.

- 200-2553 2 1/4" \$25.00
- 200-2556 2 3/8" \$27.50
- 200-2557 2 1/2" \$30.50
- 200-2558 2 5/8" \$37.00
- 200-2559 2 3/4" \$39.75
- 200-2561 2 7/8" \$43.00
- 200-2562 3" \$45.00

Save almost \$50.00

200-2570 The Complete Set \$199.95

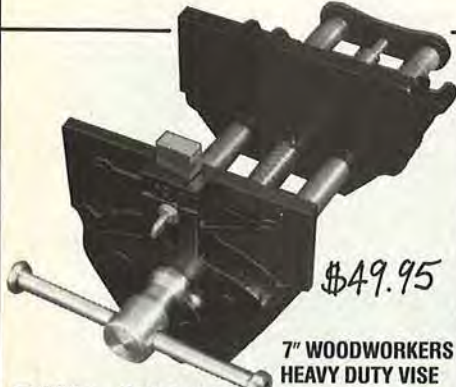

\$49.95

7" WOODWORKERS HEAVY DUTY VISE

- 22 lbs — 9" Jaw opening
- Adjustable front dog
- Quick Release Lever
- Pretapped holes for adding wood facings

300-0600 7" Heavy Duty Vise



TUNGSTEN CARBIDE HOLE SAWS

Cut clean, round holes in ceramics, plastics, fiberglass, wood and sheet metal up to 18 gauge. 10-piece set includes mandrel with carbide tipped drill and saw sizes 1", 1 1/8", 1 1/4", 1 3/8", 1 1/2", 1 5/8", 1 3/4", 2", 2 1/8".

203-0550 Carbide Hole Saw Set \$69.95



PNEUMATIC DRUM SANDERS WITH HAND HOLD

Chrome plated, ball bearing handles provides exceptional control. Use any bicycle pump to inflate drum from flexible to rigid. Supplied with one abrasive sleeve.

500-1940 2" x 8" \$49.50

500-1941 3" x 6" \$56.50

500-1942 3" x 9" \$59.95

EXTRA ABRASIVE SLEEVES

			Price
60 Grit	100 Grit	150 Grit	3 Sleeves
			1 Grit

*2" x 8" 500-1971 500-1970 500-1969 \$4.95

*3" x 6" 500-1974 500-1973 500-1972 \$4.95

*3" x 9" 500-1977 500-1976 500-1975 \$6.95

Order sleeves by 500-Number

*Minimum 3 sleeves 1 size, 1 grit

800-0700 Hand Pump

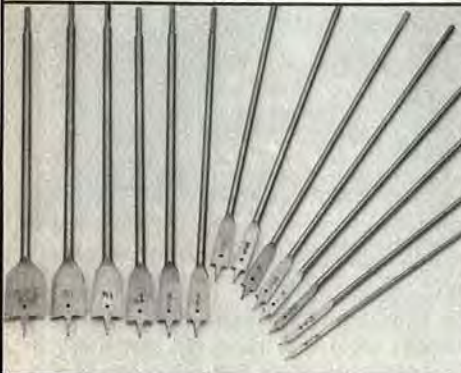

16" POWER BITS

Nothing better for reaching the "inaccessible", for making pipe, cable, wire entry holes, for drilling through floors, walls, joists, headers, or ceilings. Forged, heat treated tools. 3/8" chuck required.

200-2650 1/4" \$4.25

200-2651 5/16" \$4.25

200-2652 3/8" \$4.25

200-2653 7/16" \$4.25

200-2654 1/2" \$4.50

200-2655 9/16" \$4.50

200-2656 5/8" \$4.50

200-2657 1 1/16" \$4.50

200-2658 3/4" \$5.00

200-2659 7/8" \$5.00

200-2660 1" \$5.50

200-2661 1 1/8" \$5.50

200-2662 1 1/4" \$6.00

200-2663 1 1/2" \$6.50

200-2670 14-pc. Set \$59.95



AUTOMATIC NAIL SET

Place it on the driven nail, press and the nail is set. It is more convenient and more accurate than a hammer and ordinary nail set.

108-0542 Auto Nail Set

\$7.95



AUTOMATIC CARBIDE CENTER PUNCH

3 1/2" long with imbedded tungsten carbide. Will keep its point for a long, long time.

108-0544 Auto Carbide Center Punch

\$9.95



THE VIKING GRINDER

The 10" x 2" whetstone runs at 60 RPM in a water bath to protect the temper of your tools; the 5" wheel has an RPM of 2800. 1/4 HP motor, 110 V. Adjustable tool rests for both wheels are included as is a safety shield for the 5".

204-0075 Wet/Dry Grinder \$134.95

NEW! FROM THE FINE TOOL SHOPS



MITRE TRIMMER

Nothing better for getting a glass-like finish on your mitres. No sanding is required. Two, razor sharp blades make absolutely clean, accurate, tear-free trimming cuts. Cuts right or left. Positive stops at 45° and 90°. For intermediate cuts, provide your own jig.

Cast iron frame is ground flat. Blades are high carbon, tool steel. Perfect tool for cutting picture frames, door frames, moulding trim and railing mitres. Remember, this is a trimmer. Use it in conjunction with a mitre box.

100-0620 Mitre Trimmer **\$139.95**
 100-0625 Set of extra blades **\$59.95**



\$295.00*

*Please add \$40.00 to help defray trucking cost.

6" JOINTER WITH STAND AND GUARD

Table Size: 41 $\frac{1}{8}$ " x 7 $\frac{1}{4}$ " (outfeed table set-up for rabbeting: 6 $\frac{1}{2}$ " 37" End Mounted Fence tilts and locks to 45° front and rear. 3 Blade Cutterhead — 4500 RPM
 1 HP Motor, 13 Amp. can easily be converted to 220 V., 6.5 Amp.
 Net Weight: 187 lbs. Shipping Weight: 198 lbs.
204-0090 6" Jointer/Stand/Guard



*Please add \$40.00 to help defray trucking cost

6" x 48" BELT AND 12" DISC SANDER

An exceptional machine equal to others being advertised for \$100.00 more.

- All sealed ball bearing construction
- 2 finely milled, cast iron, tiltable work tables
 For Belt: 7 $\frac{3}{8}$ " x 14 $\frac{1}{2}$ " For Disc: 7" x 16 $\frac{1}{2}$ "
- Cast iron frame and guards
- Mitre gauge with positive stops at 45°, 90°
- Instant belt tension release makes changing belts a simple matter
- Belt can be run vertically, horizontally or at any angle in between
- Belt guard is relieved to allow you to run a board over the full, visible length of the moving belt
- 2 HP motor, 110 V., 20 Amp. can be easily rewired to 220 V., 10 Amp
- Motor Speed: 3600 RPM; Belt Speed: 5000 SFPM
- Net Weight 150 lbs; Shipping Weight: 159 lbs.

204-0095 6 x 48 x 12 Sander **\$395.00***

Special offer only with purchase of either belt and disc sander in this advert.

8 ASSORT. 6" x 48" BELTS:GRITS

500-1786 REGULAR \$42.50 SPECIAL: \$24.95



\$179.95*

*Please add \$30.00 to help defray trucking cost.

6" x 48" x 9" SANDER

Ribbed, cast aluminum table tilts and locks at any angle from 90° to 45°. Table can be used with disc or belt. Belt tilts and locks at any angle from 0° to 90°. $\frac{3}{4}$ HP Motor, 110 V., 12 Amp. can be easily rewired to 220 V., 6 Amp. Stand included. Net Weight: 115 lbs. Shipping Weight: 119 lbs.
204-0060 Sander



The Fine Tool Shops, Inc. Dept. WM57,
 P.O. Box 7091, Portsmouth, NH 03801

Ship to _____

Address _____

City _____ State _____ Zip _____

SATISFACTION GUARANTEED!

Qty.	Item	Prod. #	Price ea.	Total
MINIMUM ORDER \$20.00				

Send your Full Color Tool Catalog-

FREE!

- Check Enclosed
- Charge My Amer Express
- VISA MasterCard

Account # _____

Exp. Date _____

Subtotal	
Shipping/Handling	\$3.50*
CT 7 $\frac{1}{2}$ % Sales Tax	
TOTAL ENCLOSED	

CALL TOLL FREE 1-800-533-5305 *Except for trucking

SAVE UP TO \$275 ON AN INCA JOINTER/PLANER.

We'll give you, absolutely free, a sample of planed hardwood so you can feel for yourself what an absolutely incredible job the INCA Model 570 10¼" Combination Jointer/Automatic Thickness Planer can do.

What puts this INCA Machine on the cutting edge of woodworking technology?

First, it's the first smaller Jointer/Planer in the U.S. with the revolutionary 3-Knife Swiss Torsa Cutterhead that produces a record-setting 18,000 cuts per minute.

And, get this, you can change the double-edged knives in a record-setting 30 seconds! Start-to-finish! So you'll never have an excuse for working with knives so dull, they tear the wood.

Here's another exclusive feature: From April 20th to June 30th you can pick up the Model 570 for just \$1975. That's a shaving of \$275 off the regular price. Or, get the Model 550 (standard resharpenable knives, 12,000 cpm) for only \$1875, and save \$75.

Get your free hardwood sample (from your INCA Dealer or us). Then see your Dealer for these great deals. And if you need an industrial sized Jointer/Thickness Planer, take a gander at the Model 3000 for stock up to 15¾" wide.

For the Dealer nearest you, or more information, call toll free 800-221-2942. Or, write to Injecta Machinery Corp., Dept. 518, 10 Van Dam Street, NY, NY 10013.

No matter what INCA deal you choose, your wood will feel so much better. And so will you.

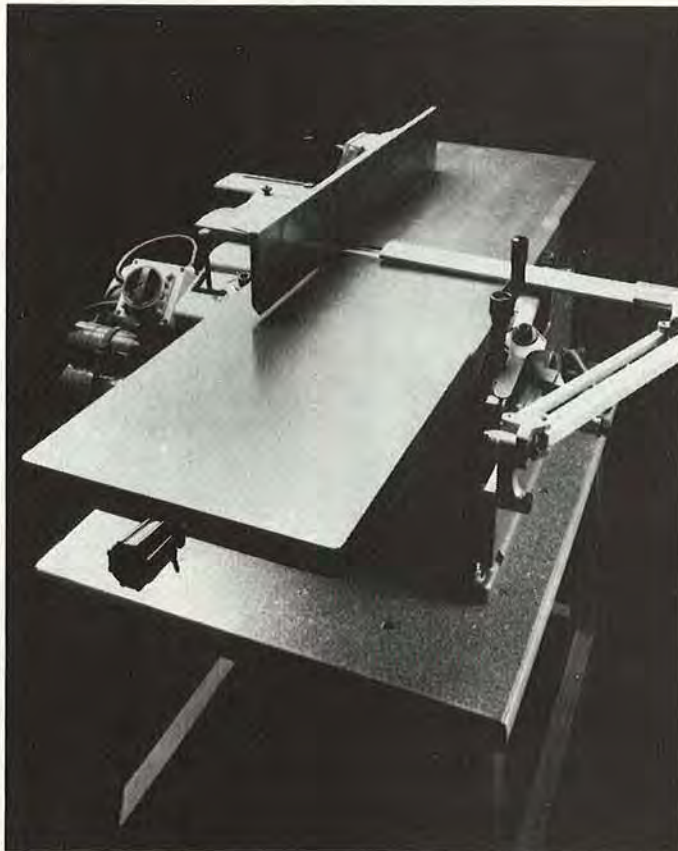

INCA

YOUR WOOD WILL FEEL BETTER. AND SO WILL YOU.

In the days when Russia claimed Baranof Island, off the coast of present-day Alaska, stands of spruce trees towered over it like 300'-tall sentinels. Botanist August Bongard was so impressed by these trees when he traveled there in the early 1800s that he named them Sitka, after the island's Russian capital.

Sitka spruce, so hardy that it grows farther north than any other conifer, also rates as the "strongman" of softwoods. Indians long ago used its tough root tendrils to sew together their bark canoes.

In modern times, Sitka spruce, with reputedly the greatest strength-to-weight ratio of any wood, took to the air. The famous *Spruce Goose* amphibious airplane, built by millionaire entrepreneur Howard Hughes in the '40s, was made from this wood. So were the frames of some English WW II fighter planes. In air battles they were so small and fast they earned the name "mosquitoes."

Boatbuilders have always found Sitka spruce well suited for masts and oars, and luthiers love it for the soundboards of stringed instruments. However, much of this wood becomes millwork, or is made up into furniture, boxes, and crates. Even larger quantities end up as paper pulp because of the wood's long fibers.

Wood identification

Often called coast spruce and yellow spruce, Sitka spruce (*Picea sitchensis*)

SITKA SPRUCE

The Softwood Strong Enough To Fly



Sitka spruce heartwood and sapwood



Sitka spruce heartwood

stands taller than any of the 18 spruce species found in the Northern Hemisphere. It grows in a coastal area about 50 miles wide and stretching some 2,000 miles from northern California to Kodiak Island, Alaska. It prefers low, wet valleys where the trees grow in dense stands and have no branches for the first 40' or more.

You'll be able to identify Sitka spruce by its size, the scaly, deep reddish-brown or purple bark, and its needles. Unique for a spruce, the needles of Sitka spruce



grow flat, sharply pointed, and a bright bluish green. Flexible cones up to 4" long develop over the summer, finally opening to drop their seeds in the fall. Where the seeds land on moist ground, they readily germinate and grow.

The color of Sitka spruce wood ranges from nearly white to pink to light brown, and sometimes has a candy-stripe look. Heartwood tends to run slightly darker.

Working properties

Very straight-grained, Sitka spruce has less conspicuous growth rings than pine. It's also about 10 percent lighter, weighing 25 lbs. per cubic foot air-dry.

In the shop, you'll find that it works easily with both hand and power tools. It nails, screws, and glues well, and takes a lustrous finish. However, because Sitka spruce is tough and stringy, band-sawing requires sharp, wide blades.

Uses in woodworking

Sitka spruce imparts no taste or gives off no odor, so use it for food canisters, boxes, and butter molds. Its strength and lightness make it perfect for painted furniture and shelving, as well as moldings and doors.

Quarter-sawn so the grain runs vertically, this wood becomes a top choice for the soundboards of guitars, dulcimers, and other stringed instruments. It flexes to aid sound.

Cost and availability

On the West Coast and in the western states, you can buy Sitka spruce at lumberyards. Elsewhere, you have to special-order it, even in thin-cut soundboard stock from specialty suppliers. A top-grade soundboard will cost from \$35 to \$50. But the price of construction grade Sitka spruce approaches that of pine. Specially sawn, vertical grain lumber may cost \$3 a board foot. 🌲

Illustration: Steve Schindler
Photographs: Hopkins Associates



 [Print this article](#)

Production woodworkers swear by them. And so do craftspeople who sell their work at crafts fairs, church bazaars, and shopping malls. But to most other woodworkers, templates remain somewhat of a mystery.

Why do people who depend on woodworking for their livelihood think so highly of templates? Two reasons, actually. First, they know that a correctly made template enables them to make more accurate cuts than would otherwise be possible. And second, with templates, these pros can work quickly without fear of making costly mistakes.

Granted, as a home woodworker, you may not be overly concerned with speed. But if you're like us, you will appreciate the accuracy you can achieve with them.

Once you master the basics of making templates, you'll be able to do all sorts of projects you never thought possible. Say, for example, you want to make a carving board with a decorative pattern carved into it. No problem! You can make one — or a hundred if you want — with a template. And what about signs with your name incised into them? You can do those, too, and they'll turn out great.

Sound like fun? We think you'll find the techniques we cover on these next several pages as intriguing as we did — and just as helpful. Developing this article certainly opened our eyes to many new woodworking possibilities, and we're sure that reading it will do the same for you.

WHAT IS TEMPLATE ROUTING, ANYWAY?

Think of a template as a rigid pattern that defines the shape of the design you are cutting into your project. But a template does more than that. It also controls the cutting action of the router. It just won't allow the router to make a mistake.

We will be telling you about two different techniques in this

article — *template guide routing* and *pin routing* with our Delta-Wing Pin Routing Attachment. Though similar, they differ in several key respects. As you can see by looking at the two cutaway sketches below, when template guide routing, the router cuts from above the work. Not so when pin routing with our attachment! Here, a guide pin follows the pattern in the template. You don't even see the cutting action when pin routing.

Also, with template guide routing, the template opening must be slightly larger than the size of the cutouts to be routed. Pin routing templates, on the other hand, duplicate the size of the pattern exactly.

There's one final difference to notice as well. If you use a tem-

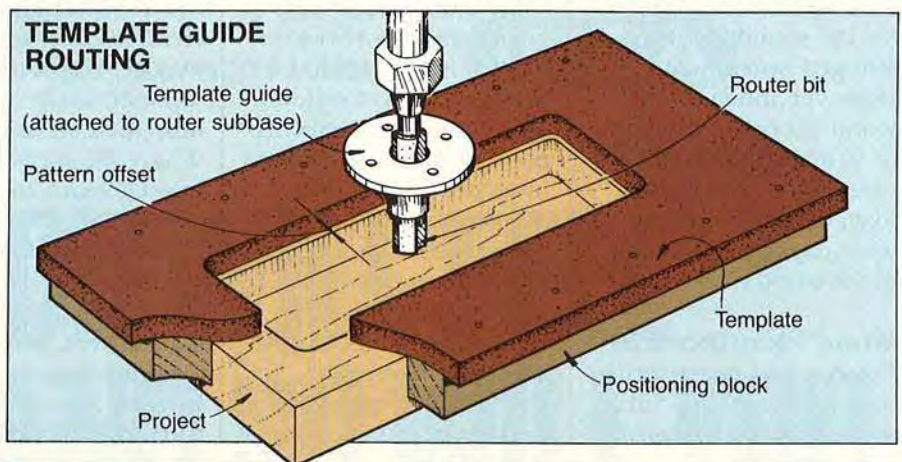

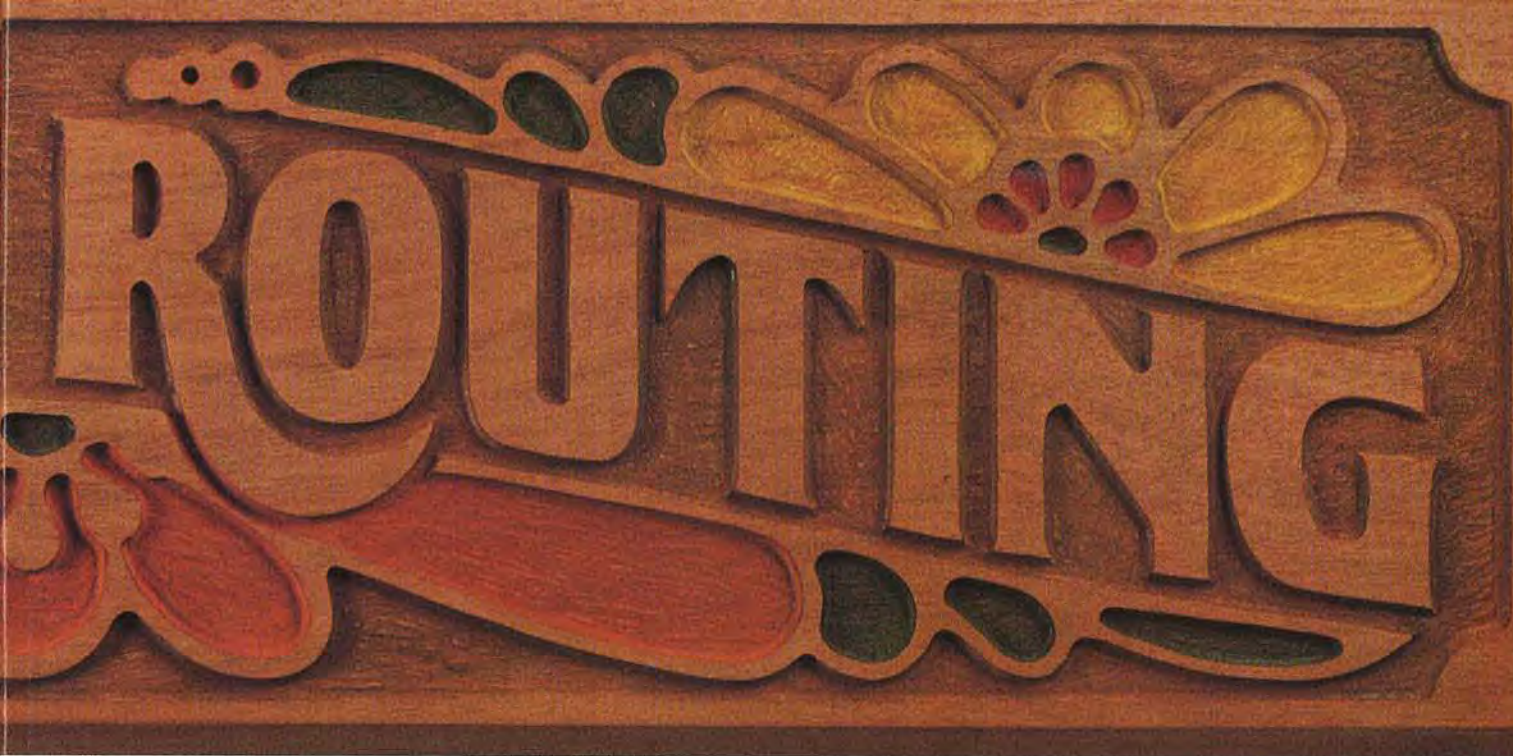

plate guide to make your project, the template itself needs to be somewhat larger than the work to accommodate the *positioning blocks* that hold the work in place.

With pin router projects, you tack the template to a *carrier*, and hold it in place over the work with *double-face tape* and *positioning blocks*. With this technique, the template and the work piece are identical in size.

Each technique has advantages in certain situations. Use these guidelines to determine which technique to use:

- Template guide routing works well with simpler projects of *any size*. Many people rout

the mortises for door hinges and make recessed cuts in lettered signs with template guides.

- Use the pin routing technique when you're making more complex creations. The carrier board to which you attach the pattern segments allows much more positioning flexibility than you have with template guide routing. (We made the TEMPLATE ROUTING sign *above* using this technique.)

MAKING YOUR TEMPLATE — THE VITAL FIRST STEP

Actually, if you do a good job of making your template, you can hardly go wrong after that. So exercise great care at this stage, the router will do the rest for you.

Both hardboard and plywood — 1/4" thick — worked well for us in the shop, but we finally settled on plywood for our templates because it seemed to hold up better over time than did the hardboard. It also was easier for us to see our pattern marks on the plywood.

How to Transfer a Pattern Onto a Template Blank

If you're lucky enough to have a full-size pattern to work from, just spray some artist's adhesive onto a piece of template material and adhere the pattern to it. If you're working with a scaled drawing, you might just as well recreate the pattern right on the template material as shown in photo A.

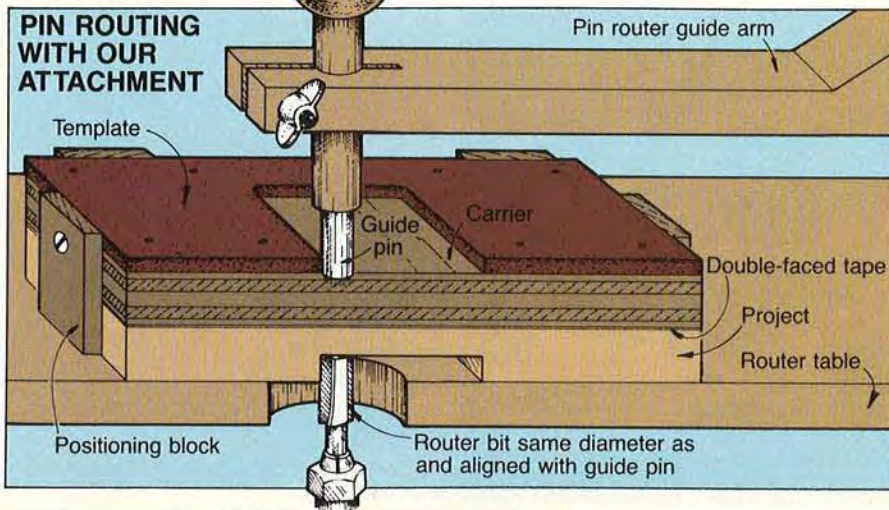

Remember that when you use template guides, you need to offset the lines of the pattern as shown in the sketch below to account for the pattern offset. (The section view shows how the guide rides against the template.)

$$\text{Pattern offset} = \text{diameter of template guide} - \text{diameter of router bit} \div 2$$

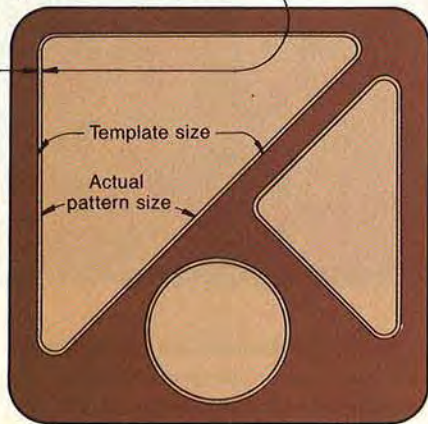

ALLOWING FOR PATTERN OFFSET

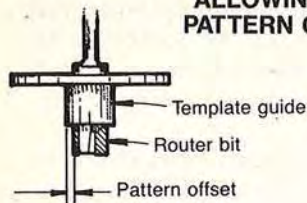

Cutting the Template

During the research phase of this article, something profoundly simple but not very obvious dawned on us. In photo B, we have two finished signs with the corresponding template in front of each. Note that if you want to create a raised image, you need a raised template. But if you're working with a recessed design, cut that part of the template away.

Note: You cut the template material the same no matter whether you're pin routing or using template guides. But keep in mind that template guide routing requires that you leave an extra inch all around the pattern so you can attach the template to the positioning blocks. If pin routing, make the template and carrier the same size as the work.



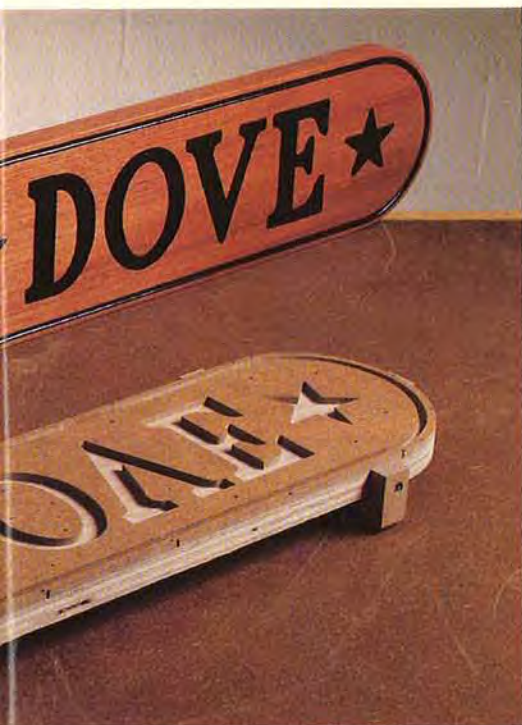

Try to machine as much of the template as possible — you'll be much more accurate that way. Drill curved areas with drill bits and circle cutters. And once you've done that, use a saber saw or a scrollsaw to cut within 1/4" of the straight lines (we show both of these operations in photos C and D).

To true up the straight lines, tack a straight piece of scrap wood to the template material as shown in photo E. Place one edge of the straightedge on the pattern line. Then, using a flush-trimming router bit, shear off the excess material.

And to smooth out any minor irregularities, sand all edges. As you can see in photo F, we use sandpaper-covered dowels for the corners and a flat sanding block for the straightaways. (We purchased automotive-type adhesive-backed

aluminum oxide abrasive from a local auto supply house.)

Also, check to see if there are any voids in the edges of the template material, as these can cause you problems when the router guide passes those points. Fill all voids with 5-minute epoxy mixed with sawdust, as shown in photo G. You'll find this same technique helpful if you happen to nick the template while routing.

Now, if you're template guide routing, drill small guide holes near each end of each side of the template material (you want the holes inside but touching the perimeter lines). Then, using the bit as a guide, as shown in the sketch below, slide the positioning blocks into position under the template material, one side at a time, and nail the template to the blocks.



TOP VIEW

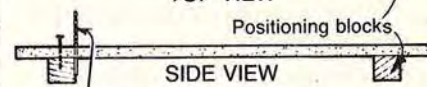

SIDE VIEW

Using same bit, align positioning blocks with guide lines.

HOW TO ALIGN POSITIONING BLOCKS

For pin router projects, position the template on the carrier, pattern side down, then nail it (or the several pieces that make up the template) to the carrier. Believe us, it's easy to get confused when positioning the template on the carrier. We found that to read the template from the bottom — like the router bit does when it's cutting — you need to view it in a mirror, as shown in photo H. (We thought of

Continued

this only after we layed out a carving board template backwards, which just goes to show you that necessity is definitely the mother of invention.)







ROUTING YOUR PROJECT — THE TEMPLATE GUIDE METHOD

Start by fitting your router sub-base with the same template guide you used to figure the pattern offset. (We made a large-diameter clear acrylic base to allow the router to span the template openings.) Keep in mind that the sleeve portion of the guide must be as short as, or shorter than, the thickness of the template material. (Since we were using 1/4" stock, we cut a hole in a scrap piece of template material to accommodate the guide, inserted the sleeve into the hole, and ground the sleeve flush with the template.)

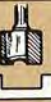
Now, referring to the Router Bit Box at right, select the appropriate bit for your project, and set the depth of cut to 1/4" or less as shown in photo I. You'll find that making several shallow passes is much easier on the router. And, you don't run near the risk of shaking the bit loose and causing deeper-than-desired cuts.

You'll need both hands to control the router, so use double-faced tape to hold the work securely to the work surface. After positioning the template over the workpiece, tip the router bit into the work as shown in photo J. (We were careful to keep the bit away from the edge of the cutout.)

The sketch at right shows the cutting sequences to follow when you rout out the recesses. First, cut around the perimeter of each recess. Then rout the field area with the grain. If you use a pointed or a rounded router bit to clean the field area, the finished surface will look hand-carved. For a smoother surface, fit a larger-diameter template guide into the router subbase to increase the offset, and clean the field with a straight or mortising bit.

ROUTER BITS USED FOR TEMPLATE WORK		
BIT	SIZES	USES
Straight 	1/8-3/4"	Cuts flat bottoms, square with walls.
Mortising 	1/2, 3/4"	Same as straight, but cuts smoother bottom.
Veining Core box 	1/8-3/4"	Cuts round-bottom grooves. If used to cut field areas, it leaves a bottom that looks like it was carved with a gouge.
V-grooving 	1/4, 1/2, 3/4"	Decorative cuts; good for recessed letters.
Bottoming 	1/2, 5/8, 3/4"	Use to smooth up bottoms already routed with another bit.
3-in-1 	7/16, 3/4"	Cuts a straight wall radiused into a flat bottom.
Keyhole 	3/8"	Cuts a flat bottom with a lip overhanging on the side wall. Use for keyhole slots and recessed drawer pulls.
Pilot pan 	1/4"	Use with guide bushings only. Cuts openings through thin panels and plastic laminates.



ROUTING OUT RECESSES USING TEMPLATE GUIDES

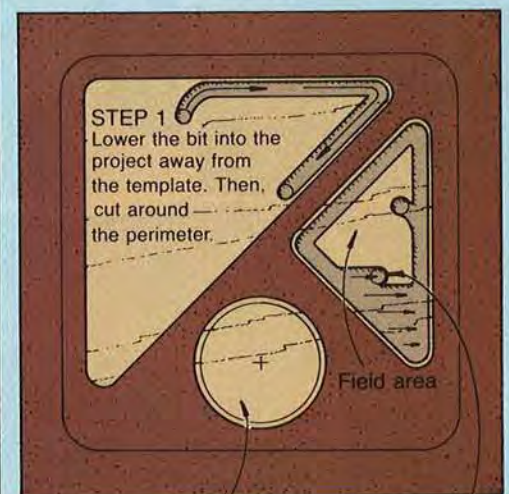

STEP 3
Clean up router marks with a sharp wood chisel and sandpaper.

STEP 2
Rout field area with the grain.



Note: the 3-in-1 bit shown in the chart will produce a straight wall radiused into a flat bottom without changing template guides.

Wood chips pile up in a hurry when hollowing-out recesses. To keep track of your progress and to prevent chips from building up in corners a situation that, can hamper cutting performance, stop periodically and blow out the accumulation. And when you're through routing, you'll need to clean up any remaining router marks with a sharp wood chisel and sandpaper.



ROUTING YOUR PROJECT — THE PIN ROUTER METHOD

To employ this technique, you'll need either an overarm pin router or the Delta-Wing Pin Routing Attachment we show you how to build on pages 38.

To set up our Delta-Wing Pin-routing Attachment, first insert the required number of spacers between the router table and the arm of the attachment. You'll want to position the arm slightly above the template. Now, fit the alignment pin through the opening at the end of the arm and insert it into the router collet. Tighten the wingnuts beneath the spacers to secure the attachment directly over the router collet as shown in photo K.

With this done, remove the alignment pin and insert a guide pin into the hole in the arm. This pin must be the same diameter as the router bit you'll use.

Lower the collet to below the work surface, and raise the arm. Then slide the template, carrier board, and workpiece into position, and lock the guide pin so it fits snugly against the carrier (see photo L). Now, raise the arm and slide the template out of the way.

Select a router bit that's the same diameter as the guide pin, and tighten it in the collet. Now, raise the bit up to a cutting height of 1/4" or less, position the work over the router bit, start the router, and slowly lower the work onto the spinning bit. Note that the guide pin needs to be in one of the recesses in the template to control the cutting action (see photo M). Once you have the work flat on the work surface, flip the hold-down into its closed position. (This lever prevents the guide pin from jumping up and out of its recess.)

The sketch at left shows the cutting sequence to use when pin routing. Here again, rout the perimeter first, then outline any shapes, and clean the field area with the grain. To prevent mishaps such as chip-out at corners and damage to the template, be sure to slow down at corners, and don't slam against the template at the ends of cuts.

The same advice we gave earlier for cleaning up the bottom of the recesses applies when using the pin-routing attachment, too. A rounded or pointed router bit will yield a hand-carved look, whereas a straight or bottoming bit will result in a much smoother surface. Keep in mind that changing to a larger-diameter guide pin and a smaller-diameter straight bit allows you to clean the field area without cutting away the coved edges. ●

ROUTING TECHNIQUES USING THE PIN ROUTING ATTACHMENT

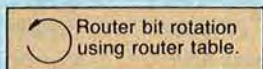

STEP 1
Rout perimeter and outline shapes.

STEP 2
Rout the field area with the grain.
(Note: Don't slam against template at ends of cuts.)

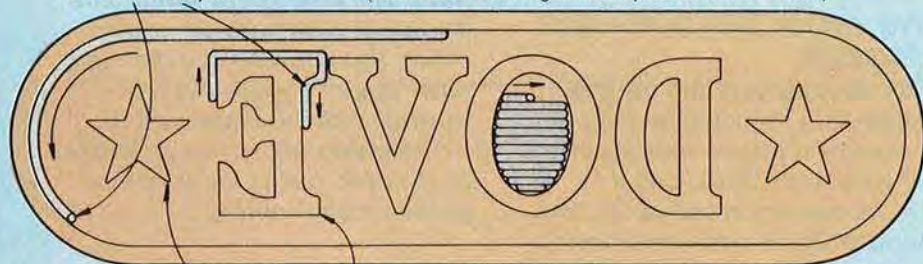

Slow down at corners to avoid chip-out.

Produced by Larry Clayton with James R. Downing
Photographs: Hopkins Associates
Illustrations: Bill Zahn

DELTA-WING PIN ROUTING

BUILD IT ONCE,
USE IT AGAIN AND AGAIN...

Have you ever wondered how those cutting boards or cheese trays with perfectly shaped patterns are made? Well, wonder no more! With our pin routing attachment and a pattern or two, you can rout all the carving boards (see ours on page 40) or other projects you want. You'll probably never have to buy another wedding or Christmas gift again, ever.

Note: The attachment fits our router tabletop which measures 12" x 18". If your table is smaller, you need to shorten the arm and reposition the mounting holes.



LET'S START WITH THE ARM AND WINGS

1 To make the arm (A), cut two pieces of $\frac{3}{4}$ " birch to $2\frac{3}{4} \times 16$ " (we used Baltic birch plywood). Glue and clamp the pieces together face to face.

2 Scrape off the excess glue, and then trim or plane the edges for a $2\frac{5}{8}$ " finished width. Trim the arm to length ($11\frac{1}{4}$ "), and save the scrap — you'll use it later for the hold-down (D).

3 Bore a $\frac{3}{4}$ " hole $1\frac{1}{8}$ " from one end, centered from side to side, in the arm where shown on the Exploded-View Drawing. Drill a $\frac{1}{4}$ " hole perpendicular to the $\frac{3}{4}$ " hole $\frac{3}{8}$ " from the same end.

4 Using a band saw, cut the arm to the shape shown on the drawing and sand smooth. Cut a $\frac{1}{8}$ " kerf $2\frac{1}{4}$ " long centered on the joint line between the two As, again referring to the drawing.

5 To make the wings (B), cut a piece of plywood to $7 \times 9\frac{7}{16}$ " long. Draw a diagonal across it, and cut down the center of the line to form the two wings. Cut a 3"-diameter hole in each wing where located on the drawing.

6 Cut or rout a $\frac{3}{4}$ " stopped groove $\frac{3}{8}$ " deep and $8\frac{7}{8}$ " long, centered along both side edges of the arm. (We clamped a stop to the rip fence and made our grooves on the table saw with a dado blade. If you follow this process, sand the front edge of each wing to match the radiused end of the stopped groove.)

7 Glue and clamp the wings into the grooves in the arm (for clamping, we used a hand screw and positioned the clamping parts in the 3" wing holes). Make certain the back edges of the wings and arm are straight and flush. Also, check that the wings are level with each other.

NOW, MAKE THE SUPPORT ASSEMBLY

1 Cut four spacers and the top support (C) to size. Dry-clamp the five pieces together with the edges and ends flush. Then, drill a $\frac{3}{8}$ " hole through each end of the lamination where dimensioned on the drawing. Remove the top support, reclamp the four spacers, and enlarge the holes in the spacers with a $\frac{1}{2}$ " drill bit.

2 Cut the hold-down (D) to size from the scrap left over from the arm lamination. Bore a $\frac{1}{2}$ " hole $\frac{3}{4}$ " deep in the hold-down where shown on the drawing. Sand a slight taper on the bottom front edge of the hold-down. The taper makes it easier for the hold-down to force the arm down for routing.

3 Clamp a $1\frac{1}{2}$ " wooden ball (available from toy-part suppliers) in a hand screw, and bore a $\frac{1}{2}$ " hole $\frac{1}{2}$ " deep into it. Cut a piece of $\frac{1}{2}$ " dowel to 2". Glue one end of the dowel into the hole in the ball, and the other end into the hold-down.

HERE'S HOW TO MAKE THE GUIDE AND ALIGNMENT PINS

Note: The alignment pin aligns the attachment with the router collet. You can also use the alignment pin as a guide pin when routing with $\frac{1}{4}$ "-diameter bits.

The guide pin, when positioned in the arm, tracks the template pattern when routing.

1 To make the alignment pin, shown at *right*, cut a piece of $\frac{3}{4}$ " dowel to $4\frac{7}{8}$ " long. Using a drill guide block (see the Drill Guide

ATTACHMENT

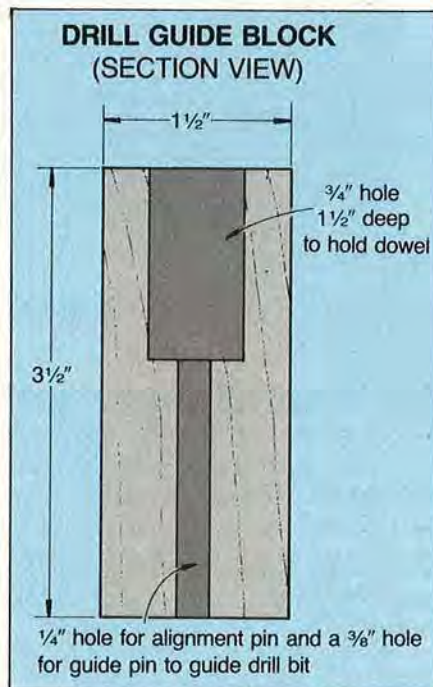
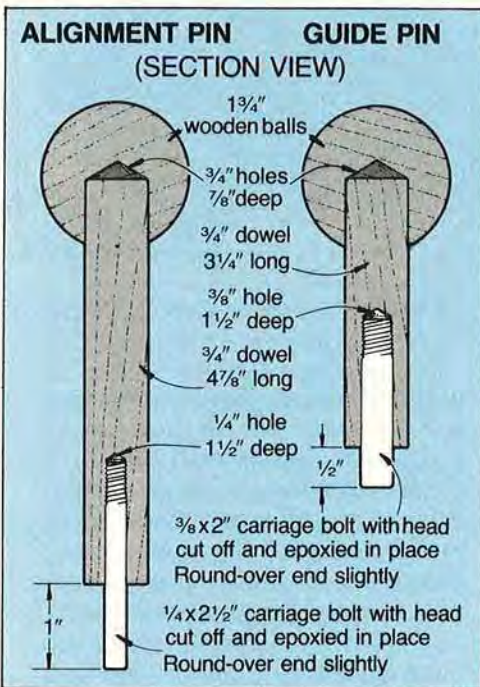
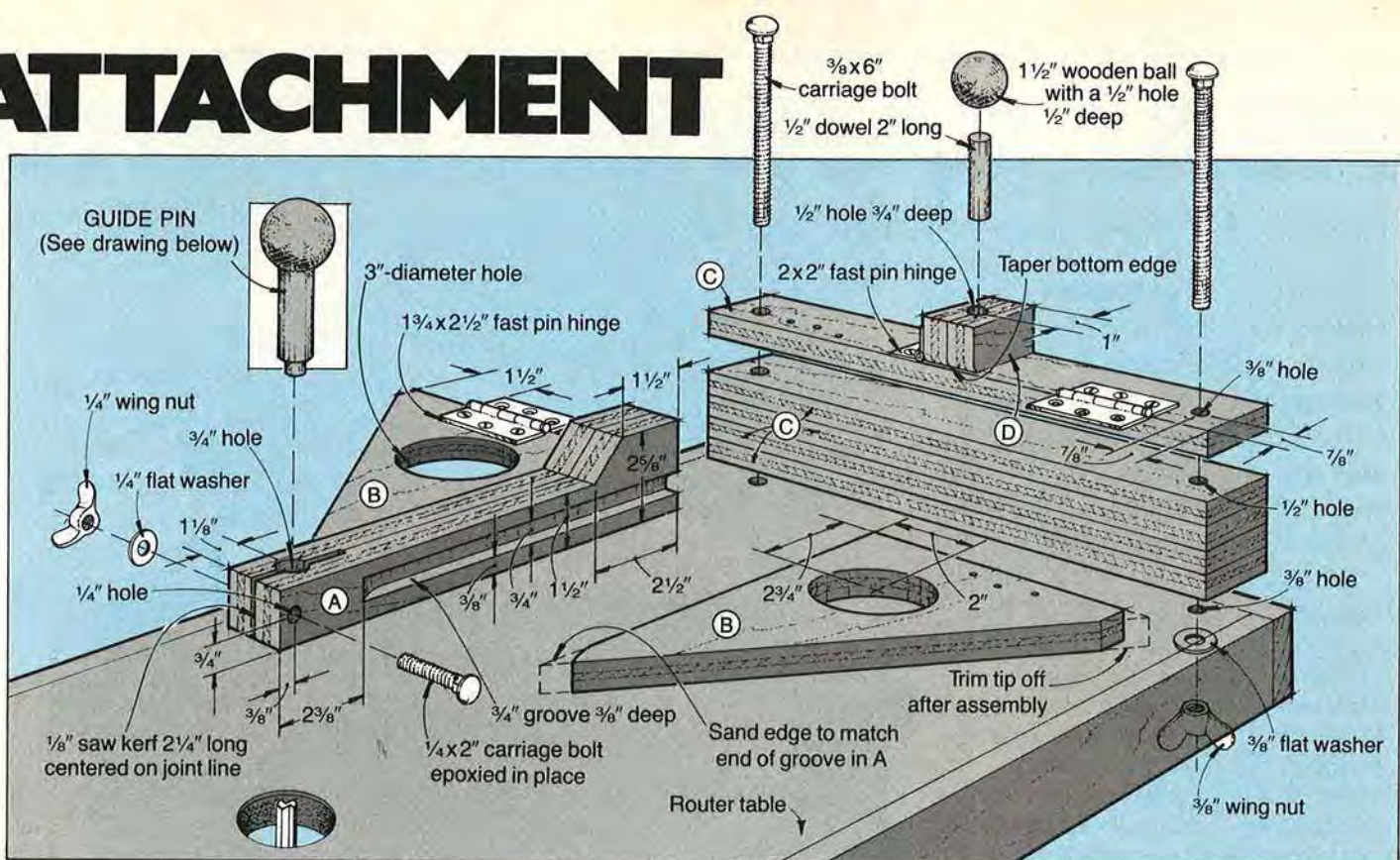

Bill of Materials					
Part	Finished Size*			Material	Qty.
	T	W	L		
A*	1 1/2"	2 5/8"	11 1/4"	birch (laminated)	1
B*	3/4"	6 5/8"	8 7/8"	birch	2
C	3/4"	2"	14"	birch	5
D*	1 1/2"	1 1/2"	2"	birch (laminated)	1

*Parts marked with an * are cut larger initially, and then trimmed to finished size. Please read the instructions before cutting.

Supplies: two 3/8 x 6" carriage bolts with flat washers and wing nuts, 1/4 x 2" carriage bolt with flat washer and wing nut, 1/4 x 2 1/2" carriage bolt for the alignment pin, 3/8 x 2" carriage bolt for guide pin, two 1 1/4 x 2 1/2" fast pin hinges with mounting screws, one 2 x 2" fast pin hinge with mounting screws, 1 1/2" wooden ball, two 1 3/4" wooden balls, 1/2" dowel, 3/4" dowel, epoxy, finish

Block Drawing for how to make one), drill a 1/4" hole 1 1/2" deep, centered in the end of the 3/4" dowel.

2 Cut the head off a 1/4 x 2 1/2" carriage bolt. Epoxy the threaded end of the bolt into the hole in the dowel so 1" of the bolt protrudes. File a round-over on the protruding end of the bolt.

3 Clamp a 1 3/4" wooden ball in a hand screw, and bore a 3/4" hole 7/8" deep into the ball. Glue the ball onto the end of the dowel.

4 To make the guide pin, repeat steps 1 through 3, using a 3/8 x 2" carriage bolt, a drill guide block with a 3/8" hole and the Guide-Pin Drawing above left.

YOU'RE ALMOST DONE — FINAL ASSEMBLY

1 Center the arm and wing assembly against the front edge of the top support. Clamp them together, drill hinge holes, and hinge the assembly to the top support. (To ensure a snug fit between the wing assembly and top support, drill the

Continued on page 81

MEAT CARVING BOARD

MAKE SEVERAL IN A HURRY WITH OUR PIN ROUTING ATTACHMENT

Carve your next holiday turkey or roast in style on this unique carving board. The maple lamination will withstand years of hard use, and the routed juice groove will catch those messy but oh-so-tasty drippings.

Note: Unless you own a pin router, you'll need to build the Delta-Wing Pin Routing Attachment described on page 38 to rout the pattern in the carving board. For more information about how to use the pin routing attachment and how to make the templates, see the article Template Routing starting on page 32.

FIRST MAKE THE MAPLE LAMINATION

- 1 Cut 16 pieces of $\frac{3}{4}$ " maple to $1\frac{3}{8}$ " wide by 19" long.
- 2 Glue and clamp the pieces together *face to face*, keeping the edges flush. (We clamped scrap stock across the pieces to keep them flat.)
- 3 Plane or belt-sand the top and bottom surfaces, being careful to keep the board flat. (We continually checked the surface for depressions with a straightedge.) The extra thickness allows up to $\frac{1}{8}$ " for scraping and sanding.
- 4 Cut the maple lamination to finished size (12 × 18"). (Our original maple stock was a fraction over $\frac{3}{4}$ " thick, so we had to trim the lamination to a 12" width. If your lamination measures wider than 12", trim equal amounts off both sides instead of taking it all off one edge.)
- 5 Lay out a $1\frac{1}{2}$ " radius at each corner, then with a band saw, cut the corners to shape. Sand the four rounded corners smooth.
- 6 Using the Handle Detail on the opposite page as a guide, rout a $\frac{3}{4}$ " cove $\frac{5}{8}$ " deep $5\frac{1}{4}$ " long centered along each end of the lamination.

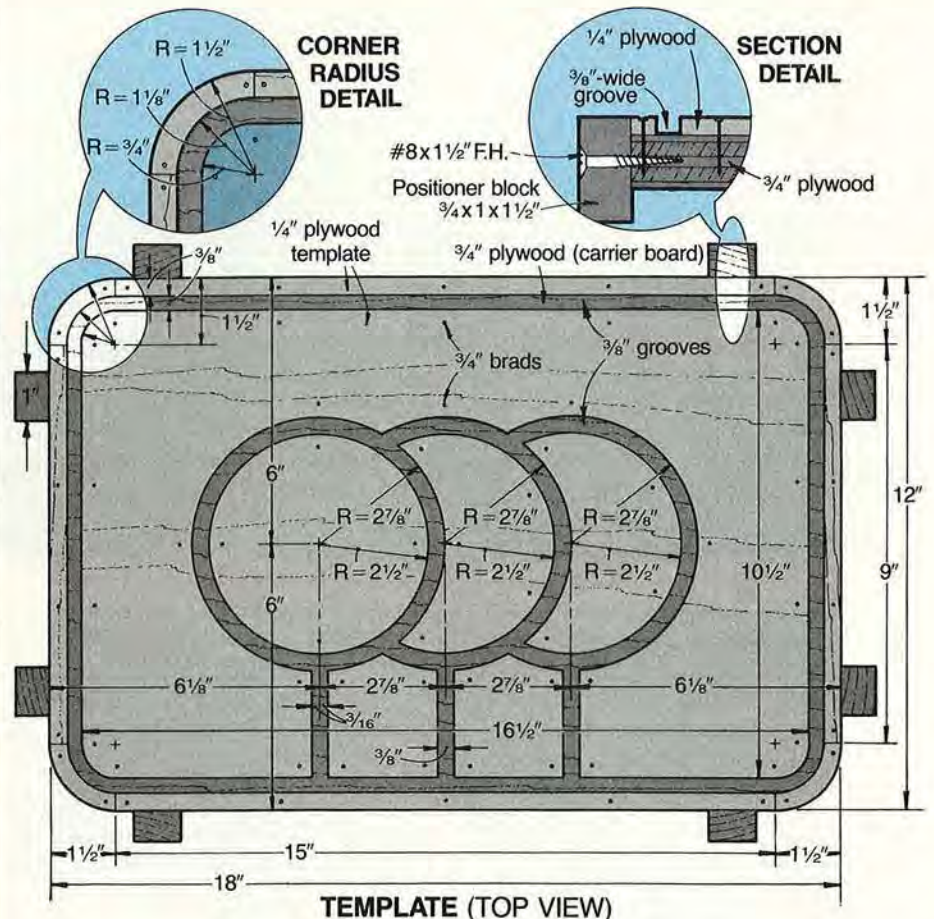

THE TEMPLATE COMES NEXT

- 1 Cut a piece of $\frac{1}{4}$ " plywood for the template and a piece of $\frac{3}{4}$ " plywood for the carrier board to 12 × 18".
- Note: Take your time when laying out the pattern, cutting and sanding the pieces, and nailing them to the carrier board. The quality of the routed pattern depends on the careful preparation of the template pieces.*
- 2 Transfer the template to the $\frac{1}{4}$ " plywood, using the dimensions on the Template Drawing as a guide.
- 3 Cut the template pieces (except the straight $\frac{3}{8}$ "-wide strips forming the outer border) to shape using a scroll saw or a band saw. From $\frac{1}{4}$ "

- plywood, cut the border strips to size on a table saw, so the grain runs lengthwise on each strip.
- 4 Sand all template pieces to finished shape. Now, glue and nail the pieces to the $\frac{3}{4}$ " plywood carrier board to form the template, carefully keeping the grooves at least $\frac{3}{8}$ " wide. (We used the $\frac{3}{8}$ " guide pin from the pin routing attachment as a spacer to maintain the $\frac{3}{8}$ " gap between the pieces.)
- 5 Rip a long piece of $\frac{3}{4}$ " scrap to a 1" width, and then crosscut it to 20" long. Now, cut eight pieces $1\frac{1}{2}$ " long from the length for the positioner blocks. Drill shank and pilot holes and mount two blocks to each edge of the carrier board with wood screws where shown

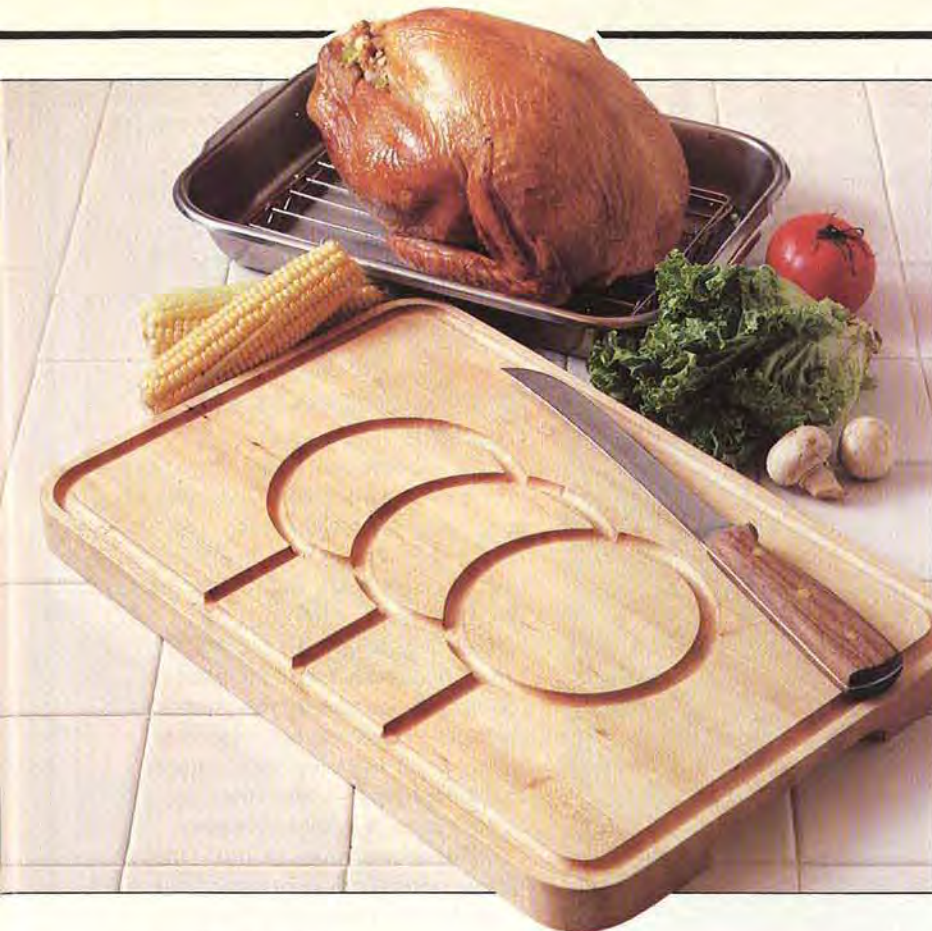

on the drawing. Then, secure the carrier board to the maple lamination with double-faced tape. The blocks and tape help hold the lamination firmly against the carrier board when routing.

READY, SET, ROUT

1 Prepare the pin routing attachment for routing as explained on page 37 under the head "The Pin Router Method".

2 Chuck a $\frac{3}{8}$ " core box bit (also called a round nose) to your table-mounted router so the top of the bit extends $\frac{3}{8}$ " above the router table.

3 With the router off, position the lamination/template assembly with the $\frac{3}{8}$ " guide pin *in* one of the grooves in the template, $\frac{1}{8}$ " above the top of the router bit.

4 Firmly holding the lamination with one hand, start the router, lower the lamination onto the spinning bit, and lock the pin router arm down with the hold-down. Now, slowly and steadily move the lamination so the guide pin follows the pattern.

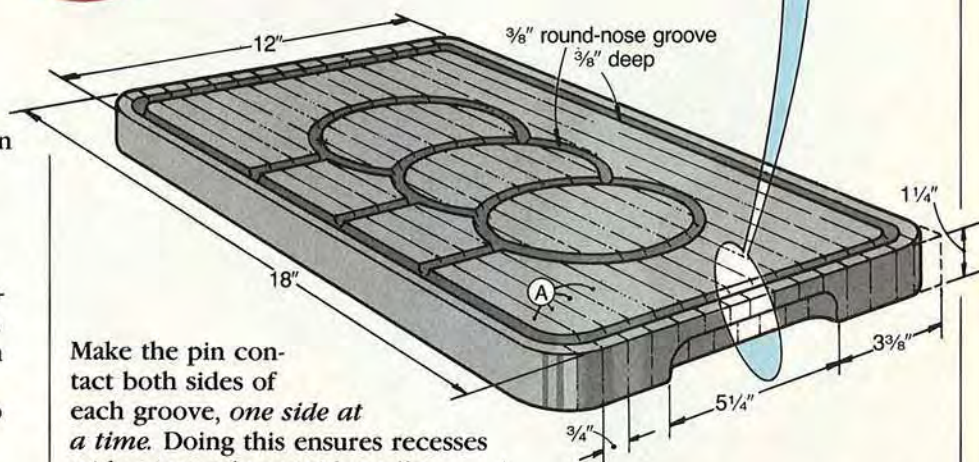

Make the pin contact both sides of each groove, *one side at a time*. Doing this ensures recesses with accurately cut side walls.

5 When you've completed routing the pattern, turn off the router, wait for the bit to quit spinning, and then unlock the arm. After checking to see that the bit made all cuts to your satisfaction, separate the work from the carrier board. Finally, finish-sand the carving board, including the juice groove. Apply a non-toxic finish.

BUYING GUIDE

• **Cloth-backed double-faced tape.** Catalog no. DF100, 70 feet, \$7.95 plus \$1 shipping and han-

dling. Craft Supplies, 1644 South State St., Provo, UT 84601, or call 801/373-0917.

• **Salad bowl finish.** Non-toxic when dry. One pint, catalog no. B603-00015, \$5.74. One quart, catalog no. B603-00016, \$9.32. Add \$2 for shipping and handling. Wood Finishing Supply Co., 1267 Mary Drive, Macedon, NY 14502, or call 315/986-4517. 🌳

Design: James R. Downing
 Photograph: Bob Calmer
 Illustrations: Kim Downing; Bill Zaun

RADIAL ARM SAWS

AMAZING CUTTING VERSATILITY
WITHIN ARM'S REACH



Print this article



If you can figure the angle, a radial arm saw most likely can cut it. And with the many attachments available, this versatile cutting machine becomes a mini-workshop. For this report, we checked out nine popular home-shop models.

THESE SAWS DO IT ALL (ALMOST)

When it comes to sheer versatility, you can't beat a radial arm saw. In fact, some woodworkers contend that if they could have only one saw in their shop, this would be it. Here's why:

This saw makes all the basic cuts: square crosscuts, angled (miter) crosscuts, bevel cuts, and rip cuts — and combinations of these, such as compound miters and bevel rips — and does so, quite easily. A radial saw also makes precise rabbets and dados, either with a conventional blade or with a dado head. And, by setting the blade in a horizontal position

(parallel with the saw table) you can perform a variety of edge- and end-cutting operations.

But that's not all! You'll find numerous accessories for attaching to the motor arbor or accessory shaft.

With them, you can rout, mold, shape, joint, disk-, belt-, and drum-sand, do horizontal boring, buffing; even polishing. Several saws, including the Inca 810, have an accessory for attaching a router to the arm for overarm routing.

The chart on page 47 lists accessories offered by the saw manufacturers. Other tool manufacturers also make aftermarket accessories and safety devices for most common radial arm saws.

You'll also find a wide variety of blades available for radial saws. These include ultra-smooth-cutting carbide blades and several types of dado heads. In fact, about every kind of blade you can put in a table saw has its counterpart for a radial saw.

RADIAL ARM SAW ANATOMY

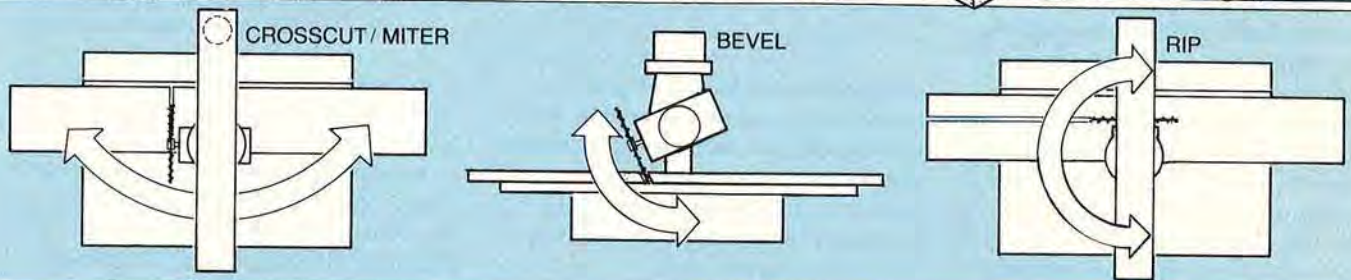
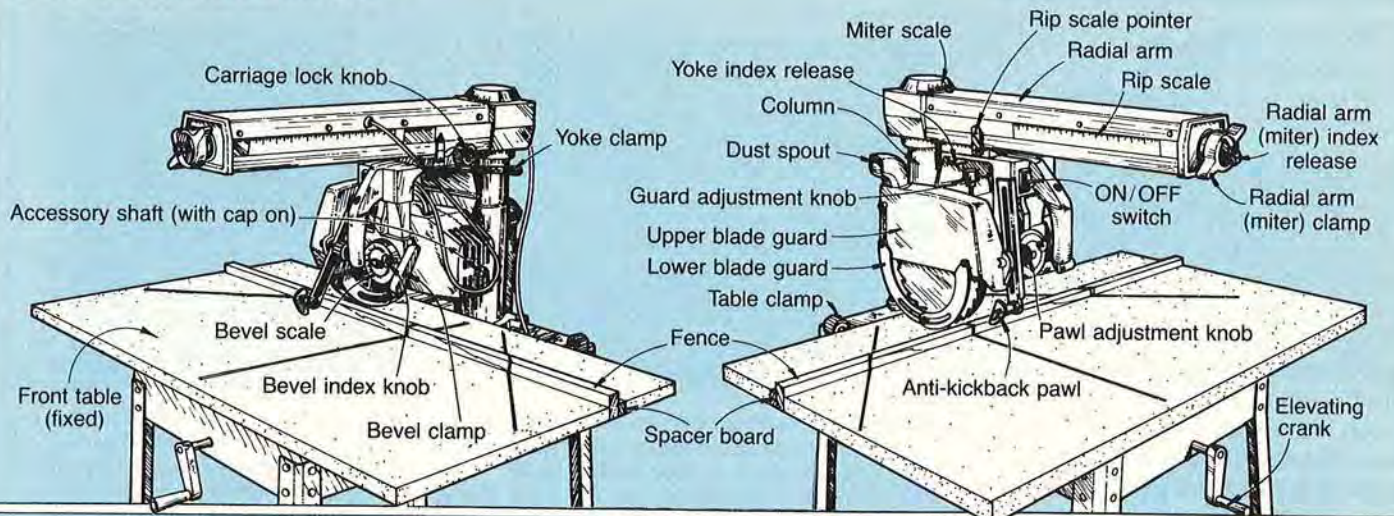

HOW THEY DO IT

The radial saw's unique design allows you to position the saw blade at any position and in any position above the work table (within reach of the saw's arm). Here's how:

The *motor and blade assembly* pivots in a *yoke*. The yoke, in turn, pivots on a *roller carriage*, which rides on tracks along the *radial arm*. The arm itself pivots on a *column*, allowing you to make left- and right-hand miter cuts. Note these basic saw movements in the illustrations *above*.

You raise or lower the arm to adjust the height of the saw blade above the table. To change blade position, set one or more of the saw's controls. To crosscut, pull the blade along the arm, through the stock. To rip, set the blade at the required distance parallel to the fence, lock it in position, then push the stock through it.

There's one exception: the Inca 810. This saw has a number of unique operating features that sets it apart, so we discuss it separately on page 46.

HOW WELL THEY DO IT

Most users agree that radial saws perform best as cutoff saws — making crosscuts. The stock remains fixed while you're cutting. That makes it easier to control long pieces while crosscutting than it would be on a table saw. And you can't beat radial saws for making fast, precise repetitive crosscuts — especially difficult ones like compound miters.

Although you can use a radial saw for making rip cuts, we find this easier to do on a table saw. For one reason, a radial saw cuts upward through the stock. This tends to lift the stock off the table. When ripping, you have to set the upper blade guard and anti-kickback pawl to help prevent lifting. But even so, the upward cutting action sometimes causes radial saws to kick back — throw the stock back at you — if the blade binds in the cut.

You'll also find it harder to make narrow rips, especially in short pieces. You just can't control the stock as safely as you can on a table saw.

Although numerous attachments are available, you may find them less convenient to use than single-purpose tools designed for these operations. If you already own these tools, you'll be less likely to use a radial saw for such operations. Even so, it can save you lots of time in cutoff work alone, and it does make accurate rip cuts.

To achieve such versatility, a radial saw has numerous moving parts, controls, and adjustments. Stresses placed on these moving parts and controls during normal operation can eventually take a saw out of alignment.

Because of this, some woodworkers consider radial saws inaccurate cutting machines. But the saws have adjustments to maintain cutting accuracy.

The more frequently you use the saw and the more accurate you want the work to be, the more attention you'll have to give to these adjustments. If you want a good idea of what's involved, check the owner's manuals for the saws you're looking at.

RADIAL ARM SAWS

HOW SAFE ARE RADIAL SAWS?

If you don't become completely familiar with the way a radial saw cuts, it can be dangerous. Here's why: When crosscutting, the blade rotates clockwise, pushing the stock down and back against the fence as you pull the motor/blade assembly toward you.

This cutting action, called *climb cutting*, can force the blade toward you if it binds and grabs the wood, or you try to cut too fast. In some cases, the blade may actually walk up and over the wood. Usually the motor will stall before the saw does this. But accidents can occur when the saw carriage unexpectedly jumps forward or pushes against the operator's sawing arm. This may twist his body, forcing his left hand (holding the stock) into the path of the blade.

For this and other safety reasons, radial saws come equipped with upper and lower blade guards (lower blade guard optional on Sears saws). Unfortunately, all of the saws we looked at, except the Inca 810 and Ryobi RA-200, have, in our opinion, poorly designed blade guards. The thin, leaf-type guards can get caught in saw kerfs cut in the fence. Still, the saws are safer with the guard on.

As mentioned earlier, when ripping, the blade cuts upward through the stock. This tends to lift the



Unlike thin steel guards on most saws, plastic lower blade guard on Ryobi RA 200 doesn't catch in saw kerfs cut in the fence. Anti-kickback pawl (in front of blade) helps prevent kickback.



Keyed switch lock on 10" DeWalt 7749 prevents unauthorized use of saw. Delta, Ryobi, and Sears also offer this feature. Large, slap-type OFF switch allows you to turn off the saw quickly in an emergency.

stock off the table and may kick it back toward the saw operator. The more powerful the saw, the greater the potential for kickback. On an underpowered saw, if the blade binds in the wood, the motor may stall, stopping the blade.

To help prevent kickback, radial arm saws come equipped with *anti-kickback pawls* (see photo above). The anti-kickback pawl digs into the wood when it starts to kick back. A splitter guide located behind the saw blade holds the saw kerf open to help keep the blade from binding in the cut. But to make these devices work correctly, you must adjust them for each cutting operation. Properly positioned, the upper blade guard

also helps prevent the stock from lifting off the table, should the blade bind.

In addition to these standard features, we also recommend using hold-down devices, such as the Ripstrate or Shophelper. They help hold the work on the table and against the fence during rip operations. Also, when ordering cutting accessories for your saw, make sure the manufacturer provides a suitable guard for them, or instructions on how to make one.

Other safety features normally found on radial saws include blade brakes (automatic or manual) and keyed locking switches (see photo above). A few offer optional carriage-return mechanisms.

HOW MUCH WILL THESE SAWS HANDLE?

Manufacturers "size" radial saws by the largest diameter blade they will accommodate: a 10" saw (the most popular size for home shops) handles blades up to 10" in diameter. The saw's maximum cutting depth — the distance between the bottom of the blade and the motor housing — increases with blade size. However, not all saws of the same nominal size have the same cutting depth, as indicated in the chart on page 47.

Generally, 10" saws will cut stock up to about 3" thick; 12" saws, up to 4" thick. But you'll pay

at least twice as much to get the extra inch of capacity offered by a 12" saw, such as the DeWalt 7790 and Delta 33-890. We included these two saws in our review, along with the Sears 19861N for those of you interested in a 12" saw. Also note that the 8-1/4" Ryobi RA-200 has about the same cutting depth as most 10" saws (3").

The length of the arm and the distance the saw can travel on it determine the width of crosscuts and miter cuts it can make. As the miter angle increases, cutting width decreases. With the blade

offset to the left side of the arm, a radial saw has less capacity on left-hand miters than on right-hand ones, unless you can set the fence closer to the rear of the table.

Arm length and saw travel also govern maximum rip capacity. If you plan on ripping 4'-wide panels, you'll need a saw with a maximum rip capacity of 24".

The chart on page 47 shows the various cutting capacities of the saws we looked at. Note that the Inca 810 has an optional arm. It allows a maximum 28" crosscut — widest of the saws we looked at.

CONTROLS: WHAT TO LOOK FOR

Radial arm saws have eight basic controls which allow you to set the saw blade exactly where you want it and keep it there: the elevating crank, radial arm clamp, radial arm index release, carriage lock knob, yoke clamp, yoke index release, bevel clamp, and bevel index knob. The drawing on page 43 shows the locations of these controls on a typical radial arm saw.

You'll find some of the controls in different locations on different saws. So if you expect to change blade positions frequently, look for "up-front" controls. Both Delta saws, for example, have convenient control positions, as well as solid, positive locking and clamping mechanisms.

We found column-mounted elevating crank and arm controls on the 12" DeWalt 7790 hard to reach from the operator's position. But we like their solid, positive operation. Because such controls have fewer moving parts, they're less likely to need frequent adjustment to maintain accuracy.



The DeWalt 7790 and Black & Decker 1712 have column-mounted arm controls and elevating crank (photo above). These controls are less handy to operate, but have fewer moving parts, so they're generally easier to maintain and require less-frequent adjustment. We found the controls on the Sears easy to use,

especially the up-front quick-release latches to change fence positions (most saws use screw clamps at the rear of the table). Its under-table elevation crank also operated easily and with very little play. Cranks in this location can be sloppy because they're connected to the column by a long rod.

KEEPING THE SAW ON TRACK

Look for solid arm construction and a smooth-gliding carriage. You'll find arms made of cast iron, cast aluminum, or heavy-gauge formed steel. Cast iron has the greatest rigidity and durability.

The two DeWalt saws and the 10" Delta 33-990 have four ball-bearing carriage rollers that ride on internal channels milled into a heavy cast-iron arm. With this sturdy design, you're not likely to damage the tracks accidentally.

The 12" Delta 33-890 has concave roller bearings that ride on replaceable steel track rods recessed into a cast-iron turret arm. When the carriage becomes

loose in the track due to wear, you can simply rotate the rods to expose a smooth, unused surface.

On both Ryobi saws, the carriage roller bearings ride on tracks formed into a heavy-gauge stamped-steel arm. Because steel dents easily, the tracks are more prone to damage than cast iron ones.

The Sears saw has an unusual design: the carriage glides on nylon blocks in a formed steel track attached to a cast-aluminum arm. Roller bearings push the carriage downward against the track. Like the Ryobi saws, the steel tracks are prone to damage, but they're replaceable.



THE DELTA TURRET ARM

The unique "turret arm" design of the 12" Delta 33-890 (and larger Delta saws) allows the arm to rotate 360° above the work table. This provides full table capacity for left- and right-hand miters. (On most single-arm saws, the blade leaves the table on left-hand miters). It also allows miter cuts at angles greater than 45°.

MOTOR — HEART OF THE SAW

All radial saws use standard induction motors, except the two Ryobi models. They use brush-type universal motors. Although we're still skeptical of the life expectancy of these small, high-speed motors on stationary tools, the one on the RA-200 has an advantage. Its small size gives this 8-1/4" saw a 3" cutting depth — about the same as most 10" saws.

On most other radial saws, the blade runs directly off the motor arbor at 3450 rpm. The Ryobi saws, with high-speed motors, have a built-in gearbox to reduce motor speed to an acceptable blade speed (4,500 rpm on the RA-2500; 5,000 rpm on the RA-200). The accessory shaft runs at motor speed (17,600 rpm on the RA-2500; 18,500 rpm on the RA-200) rpm so you can attach router and shaper bits directly to the shaft.

Some radial saws use totally enclosed, fan-cooled (TEFC) motors; others use open, drip-proof motors (see chart on page 47). In a shop environment, sawdust will find its way into open motors, which will shorten their life.

Continued

RADIAL ARM SAWS

WHY WE CHOSE THESE SAWS

The saws shown here represent most of the consumer-type radial saws readily available to the home woodworker. (In addition to their electronic model, Sears offers 10" and 12" saws, which we included in the chart on the facing page). Delta, DeWalt, and several other manufacturers offer larger, industrial-type saws up to 20", but these are in an entirely different price range.

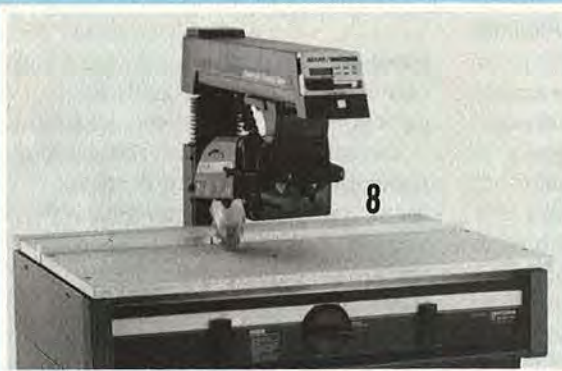
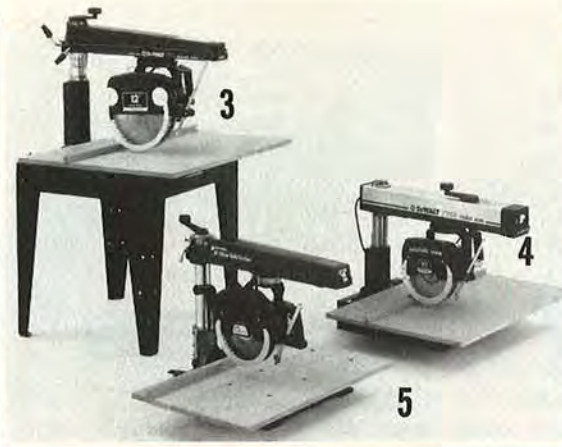

THE SAWS

1. 10" Ryobi
Model No. RA-2500
2. 8 1/4" Ryobi
Model No. RA-200
3. 12" DeWalt
Model No. 7790
4. 10" DeWalt
Model No. 7749
5. 10" Black & Decker
Model No. 1712
6. 12" Delta
Model No. 33-890
7. 10" Delta
Model No. 33-990
8. 10" Sears
Model No. 19861N
9. 9" Inca
Model No. 810

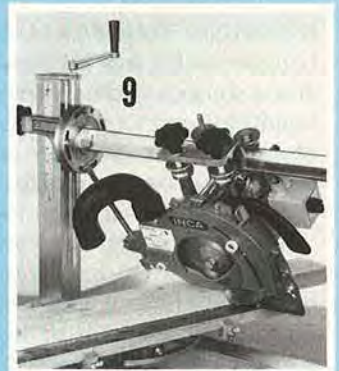

TWO NEW PORTABLES

If you don't have shop space for a full-size radial saw, check out one of the compact benchtop models. The cast aluminum arm, column base, yoke, and motor housing on the 10" Black & Decker 1712 contribute to its light 65 pounds. Though you can't expect it to be as rugged as the big boys, it has exceptional rigidity and cutting performance for its size and weight. The fold-up feature, shown at *right*, allows you to store it in a small space or easily haul it around with you.

The 8 1/4" Ryobi RA-200 won't fold flat like the Black & Decker, but you can easily carry this 53-pounder around the house and

yard for on-site work. We also found this saw a good performer for its size.

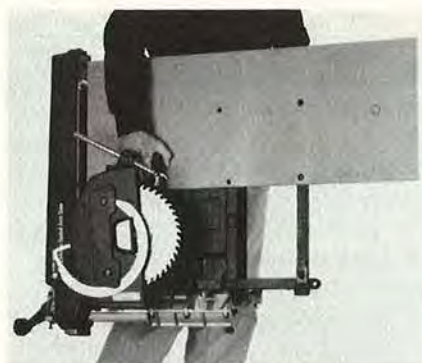

Black & Decker folding saw: a compact, walk-away winner.

INCA 810:

A UNIQUE SAW, INDEED

This Inca not only looks different: it works differently, too. First, it cuts on the *push stroke*, not the pull stroke as other radial saws do.

Second, to make miter cuts, you rotate the table, not the arm. This enables you to make wider miter cuts than on most other saws. But it also means the saw needs clearance on all sides when miter-cutting long boards, so you can't put it against a wall.

Third, the Inca's fixed-yoke design requires physically rotating the radial arm to make bevel cuts. The photo *above* shows the saw set up for a compound miter. We

RADIAL ARM SAW BUYMANSHIP

MANUFACTURER	MODEL NUMBER	CUTTING CAPACITY					INDEX STOPS			MOTOR				MATER. ³		SIZE ⁴ W x D x H (INCHES)	TABLE W x D (INCHES)	WEIGHT (LBS)	SUGGESTED PRICE ⁵	
		BLADE SIZE (DIAMETER, INCHES)	DEPTH OF CUT (INCHES AT 0°)	DEPTH OF CUT (INCHES AT 45°)	MAXIMUM CROSSCUT (INCHES)	MAXIMUM RIP (INCHES)	MITER	BEVEL	TYPE ¹	HORSEPOWER ²	VOLTS	AMPS	NO-LOAD BLADE SPEED (RPM)	ACCESSORY SPINDLE (Y, N)	ARM					COLUMN BASE
Black & Decker	1712	10	2 13/16	2	13 3/8	19 3/8	0°, 45° L&R	0°, 45°, 90°	TEFC	2*	120	11	3,450	N	CA	CA	34 x 26 1/2 x 24*	34 x 21	65	\$384
Delta	33-890	12	4	2 1/2	14 3/8	24 1/4	0°, 45° L&R	0°, 45°, 90°	TEFC	1 1/2	115/230	11/5.5	3,450	N	CI	CI	30 x 32 x 63 1/2	25 1/2 x 30	300	\$1,422
Delta	33-990	10	3	2 1/4	12 3/4	24	0°, 45° L&R	0°, 45°, 90°	TEFC	1 1/2	115/230	11/5.5	3,450	Y	CI	CI	42 x 37 x 53 1/2	42 x 24 3/4	178	\$630
De Walt ⁶	7790	12	4	2 3/4	16	27	0°, 45° L&R	0°, 45°, 90°	TEFC	3 1/2*	120/240	17/8.5	3,450	N	CI	CI	38 1/2 x 34 x 53 1/2	38 1/2 x 29		\$1,045
De Walt	7749	10	3	2 1/2	14 1/2	24 1/16	0°, 45° L&R	0°, 45°, 90°	ODP	2 1/2*	120/240	12.5 x 6.25	3,450	Y	CI	CI	36 1/8 x 31 1/2 x 24*	36 1/8 x 24 3/8	129	\$621
Inca	810	9	2	1	16	25	0°, 45° L&R	NA	ODP	1.3	110	9	3,500	N	FS	FS	29 x 34 3/4 x 25 3/4*	23 3/8 x 32	69	\$595
Ryobi	RA-2500	10	3	2 1/4	14 1/2	24 1/2	0°, 45° L&R	0°, 45°, 90°	ODP	2 1/4*	115	11	4,400	Y	FS	FS	40 x 38 x 55 1/2	40 x 25	106	\$616
Ryobi	RA-200	8 1/4	2 1/2	1 1/8	10 1/8	19 1/8	0°, 22 1/2°, L22 1/2°, 45° R	0°, 45°, 90°	ODP	2*	115	11	5,000	Y	FS	CA	27 1/2 x 32 x 20 1/4*	27 1/2 x 21 3/8	53	\$445
Sears	1989N	12	4	2 1/16	16	26	0°, 45° L&R	0°, 45°, 90°	ODP	2*	240	7	3,450	Y	CA	CA	44 x 32 x 28*	44 x 27 1/2	171	\$649.99
Sears ⁷	19861N	10	3	2 1/4	15 1/2	26	0°, 45° L&R	0°, 45°, 90°	TEFC	1 1/2	120/240	11/5.5	3,450	Y	CA	CI	44 x 36 x 57	44 x 27	278	\$469.99

1. (TEFC) Totally enclosed, fan-cooled; (ODP) Open, drip-proof
 2. Continuous horsepower (*) indicates maximum developed horsepower.
 3. (CI) Cast iron; (CA) Cast aluminum; (FS) Formed steel
 4. Height includes stand, (*) indicates height without stand

5. Most saws often discounted 10-30% below manufacturer's suggested list price.
 6. Sears offers similar saw. De Walt is a division of Black & Decker.

7. Available with one-, two-, or six-drawer cabinet (shown on facing page). Sears also offers same basic saw without electronic readout.

MANUFACTURER'S ADDRESSES & ACCESSORIES

This list includes most of the optional accessories offered by saw manufacturers. For additional details, write to the following addresses for catalogs.

Black & Decker/DeWalt 626 Hanover Pike, Hampstead, MD 21074.

Accessories: Automatic carriage return, blades, dado head, disk and drum sanders, planer head, roller head stop, router attachment, saber saw attachment, shaper head set

and fence, stand, tool guard (shaping, jointing, disc sanding, planing).

Delta International Machinery Corp. 246 Alpha Drive, Pittsburgh, PA 15238.

Accessories: Automatic carriage return (33-890 only) blades, dado head, disk and drum sanders, molding cutterhead and knives, molder/shaper guard, shaper bit adapter, stand, stand caster set.

Inca: Garrett Wade 161 Ave. of the Americas, New York, NY 10013.

Accessories: 9" carbide blades, extension arm (increases crosscut capacity to 28") router carriage (fits Porter-Cable routers), stand.

Ryobi America Corp. 1158 Tower Lane, Bensenville, IL 60106.

Accessories: Blades, dado head, disk and drum sanders, molding cutterhead and knives, router bit adapter and bits, shaper bit

adapter and bits, shaping table, stand.

Sears, Roebuck & Co. (contact local store for latest tool catalog)

Accessories: Automatic carriage return, belt sander, blades, dado head, depth gauge, disk and drum sanders, drill chuck, hold-down clamps, molding cutterhead and knives, molding/dado head guard, surface planer attachment, router attachment, stand, more.

found it inconvenient having to loosen and retighten the four hex-head bolts attaching the arm to the column to set the bevel.

Fourth, to set up for rip cuts, you must remove the blade/motor assembly from the arm to reposition it parallel to the fence. The two large black knobs (see photo) lock the carriage to the arm.

If you expect to change blade settings frequently, you may find the Inca more of a hassle to operate than conventional saws. However, its simplistic, rugged design makes it easy to adjust for accurate cutting. But test it out for yourself — just for the fun of it.

SEARS' LCD READOUT: GIMMICK OR GLIMPSE OF FUTURE?

Unlike their first electronic radial saw, Sears does not use electronically controlled motors to operate



Sears electronic LCD readout: four super-accurate measurements.

the saw positions on their new line. The digital electronics simply read out the manually set controls.

Nonetheless, we found the LCD readouts to be accurate, easy to calibrate, and easy to read. Miter and bevel measurements read out in 1/2° increments; elevation and rip measurements in hundredths of an inch. In this case, we prefer the digital device to the printed or engraved scales on most stationary tools, which we often find hard to read and set accurately.

Produced by Jim Barrett
 Technical Consultant: George Granseth
 Photography: Bob Calmer
 Illustrations: Kim Downing; Bill Zann

DUST CONTROL

How One Minnesota Woodworker Designed His Own Central Collection System

Tired of shifting your shop vac or portable dust collector from one tool to another? Maybe it's time you thought about a central dust collection system. As this craftsman discovered, an efficient system doesn't have to cost you a bundle of money. And, using the guidelines in this article, you can do all the work yourself.

It won't take you long to tick off all the reasons for controlling wood dust and chips in your home shop — convenience, health, safety. In fact, and as Bryan Lamont, a Coon Rapids, Minnesota, woodworker will attest, they sometimes come to you in a flash!

Fifteen years ago, when Bryan was a high-schooler, he was sanding a project in his dad's home basement shop. Suddenly, there was a sound like a sonic boom and the furnace in the next room belched fire! "It really scared the liver out of me at the time," he recalls. "But that incident made me keenly aware of one of the problems with wood dust."

That scare didn't erase Bryan's woodworking interest, though. He went on to study it in technical school and became a cabinetmaker. Now, he sells industrial pollution control equipment and machinery for G.C. Peterson Co. and pursues woodworking off-hours in his home basement workshop that he's outfitted with a central dust collection system.

Bryan's setup uses a 2-hp. collector to whisk away debris from a full complement of tools through a 4" duct system. He uses both rigid and flexible pipe for the ducts in his 23x13' shop. The system (less the collector) cost about \$300.

How do you know if you're ready to go all out with a central dust collection system? "I think it boils down to how many tools you have," suggests Bryan. "If you only have one or two major woodworking machines, the advantages of a central system might be questionable. But with three or more major power tools, there's no question you'll enjoy a system for the convenience alone."

DESIGN TIPS FOR A CENTRAL SYSTEM

When Bryan decided to put in a central system, he discovered that there's plenty of help available if you want to do it yourself. A lot of engineering research has been done on the installation of large commercial systems, and these same principles apply to the home shop — but scaled down. Besides talking to a number of dealers and pros who do commercial installations, Bryan relied heavily on the data in a guide available from Delta International (see where to write at the end of this article). Here's what he found out:

- **Duct diameter influences air flow velocity.** Usually, 4"- or 5"-diameter duct pipe will do the job in a home shop. Use too small a diameter and you risk clogging; too large and airflow velocity over a long run may actually drop below 3,500 feet per minute (FPM), a point where dust actually settles out.
- **Minimize resistance with smooth duct material.** You'll have less resistance and air turbulence in a smooth-wall, round-pipe duct. Reinforced steel ducting fills the bill. It won't collapse, doesn't have to be grounded as does PVC drainpipe,

and only costs about \$1.20 per foot. In ribbed hose or corrugated material, friction can reduce air velocity by 50 percent.

- **Use gradual curves to change airflow direction.** Sharp bends in a duct system cause air and debris to hit the duct wall, bounce back, and produce turbulent resistance. This resistance can be 100 percent higher in a 90° T-fitting than in a gently curved, 90° elbow.
- **Avoid connecting small-diameter duct to large-diameter duct.** A small duct *diffuses* the volume of air entering the larger duct and causes clogging.
- **Use hoods or flanges at inlets to the system.** Attach all hoods directly to tool stands or cabinets. Unattached hoods or duct pipe should have at least a 2"-wide flange on all sides to prevent interfering airflow into the system from behind the inlet.
- **Shut off airflow at unused tools.** Place plugs or slide gates at the inlets of unused tools so you can shut them off from the system. Then, you'll have full air-flow at the tool you're using.

HOW BRYAN PLANNED HIS SYSTEM

With the above design tips in mind, Bryan began planning his system. He found that with a central dust collection system, you have to balance a number of variables:

- Length of proposed duct run from the tools to the collector
- The specific cubic feet per minute (CFM) pulling power needed at each stationary tool
- Diameter and type of ducting
- The CFM capability of the collector to be used.



Less the 2 hp. collector, shown in the far back corner, Bryan Lamont's central dust collection system cost him about \$300.

Bryan followed these steps and you can, too:

Step 1. *Plan the duct system on paper.* Show tool locations and where you want the dust collector (it doesn't have to be centrally located where it takes up work space). Starting at the collector, draw in the main duct. Then, add branches or sidelines to all the tools, including vertical drops, necessary curves, and angles.

Step 2. *Total the length of your main duct and its branches.* In figuring, consider straight length of ducting as well as *equivalent length* (see chart at right).

LENGTH VALUES FOR DUCTS AND FITTINGS

Duct or fitting	Equivalent length
Smooth wall pipe	Actual length
Corrugated pipe/hose	Actual length x 1.5
Duct inlet from tool cabinet/built-in hood	0'
Flanged hood inlet	0'
Unflanged hood inlet	10'
90° T-fitting or 90° hose bend	10'
45° curved elbow	5'
Side leg of 90° tee	20'
Side leg of 90° wye tee	5'
Straight-through tee leg	0'
Slide gate	0'
Five-foot ribbed hose	0'

DUST CONTROL



Photos, clockwise from above:

The 4" flexible hose connecting Bryan's table saw to the system doubles as a floor sweep. He uses it to collect odd debris missed by the system. It's flexibility allows him to reach nooks and crannies.

Hoods like this one on Bryan's shaper directs air-flow into the duct for a clean sweep of wood dust and chips. The short connection doesn't lose much power to friction, and makes up for the uncurved tee.

Under the jointer, the hood serves as a collection box with the duct attached at bottom to gather the most chips. For a good fit, Bryan had to adapt the hood with a wooden reduction plate.

For his planer, Bryan installed a ceiling drop of flex hose. Being near the collector, the line has enough power to lift wood chips up, then over to the collector in the corner.

Metal slide gates allow Bryan to shut off ducts to unused tools for maximum CFM at the tool in use. Duct tape works to hold the connection together, but you can also use rivets or sheet metal screws.

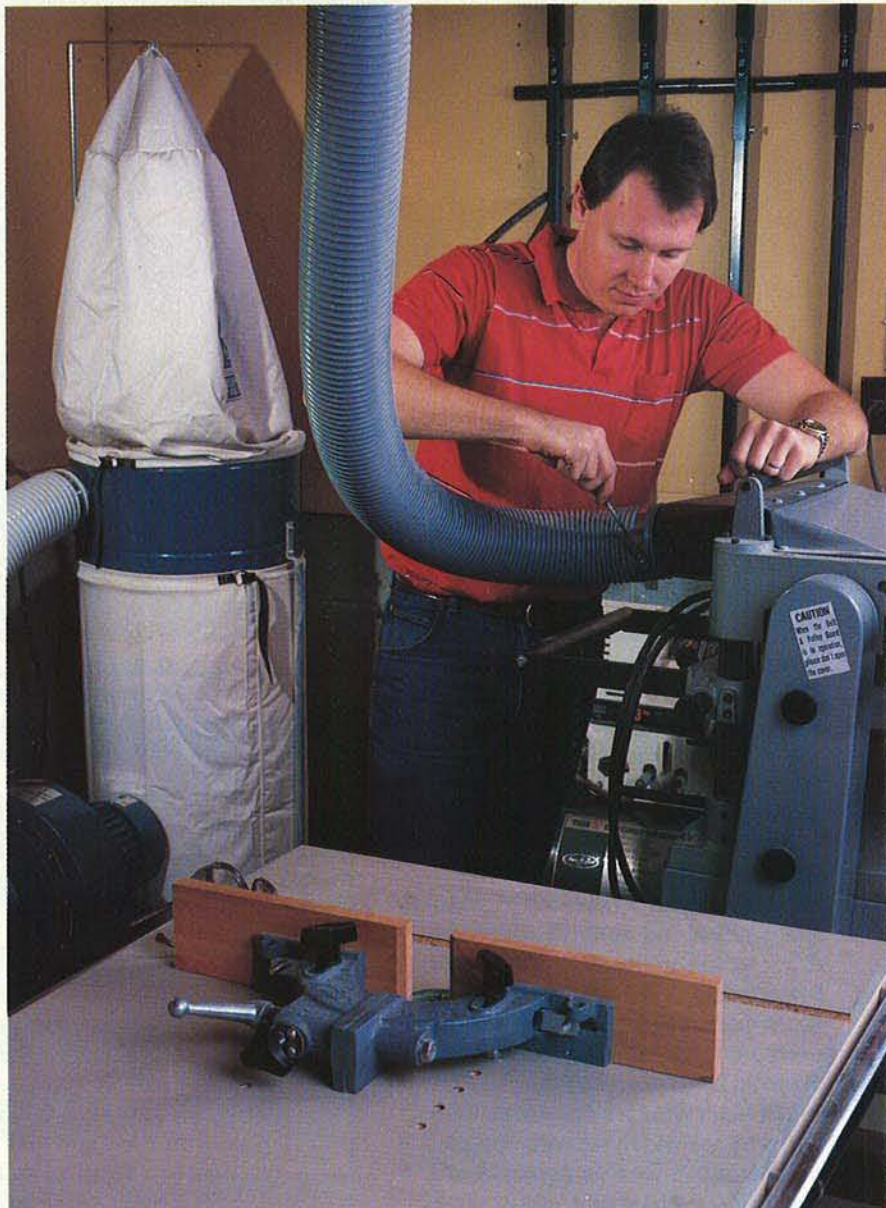

Equivalent length means assigning each type of fitting that has more airflow resistance than straight duct, such as elbows, a value equal to a certain length of straight duct. Add up separately all the values for the fittings and straight runs from each of your tools on the system to the dust collector, then total. This ensures that you will arrive at the longest possible length in your system for the accurate calculation of available CFM at a tool.

Step 3. Determine the CFM needs for each of your tools on the system. From the list below, find the

AIRFLOW REQUIRED AT POWER TOOLS		CFM
Band saws up to 2" blade		450
Belt sanders	up to 6"	500
	up to 9"	750
Disk sanders	up to 12"	400
	up to 18"	650
Drum sanders		400
Jointers	up to 6"	400
	up to 12"	700
Thicknessers		700
Radial arm saws, 10"		400
Table saws, 10"		400
Shaper, 1/2" spindle		400

approximate CFM requirement for the power tools on your system (or refer to an owner's manual) and jot them down on your system sketch.

Now, with your notations from the chart, you'll know exactly how much airflow you'll need at each tool to remove dust and chips when all other inlets are closed. Use the *highest* of these CFM figures for your tools to find the correct duct diameter your system will require in the next step.

Step 4. Find the duct diameter that will do the job. Charts like the one below, available at equipment dealers, help determine the duct diameter that, when coupled with a specific dust collector, will provide your system with enough CFM at each tool.

Let's say, for instance, that you have a 2-hp. dust collector with a 5" outlet port, so you'd like to use 5" ducting. After totaling up the duct length in feet of your longest run (add lengths of straight duct and equivalent lengths of fittings), look on the left side of the chart and find the number that corresponds to your total. In this example, if your total was 91', you'd enter the chart just above 90 and read across to locate the curve for 5" duct. Now, follow the straight line down from that curve which

leads to the approximate CFM you need to have at the tool on the end of the run.

A 10" table saw, in this instance, needs 400 CFM, and at 91' of 5" duct your system would generate 475 CFM — more than enough. You can also see that 91' of 4" duct wouldn't deliver the CFM you need for your table saw. But 5" duct will more than do the job for duct systems of 90' or less and CFM requirements up to about 700. You might want to check duct length from every one of your tools on the system individually against the chart, just to be sure you'll get enough CFM at every one of them.

What if you can't find a matchup with a certain diameter of duct and the correct CFM? You'll have to do some redesigning. You can shorten duct run by relocating tools, cut down on high-resistance fittings or materials, opt for a different diameter of duct, or go with a larger dust collector. Most home shops use either a 2- or 3-hp. collector to power a central system since most woodworking hobbyists only use one dust-making tool at a time.

Caution: Airflow/duct length charts, such as our example, are specific to brands and models of collectors. They may or may not work for your present collector or any other collector. For accurate calculations, visit a dealer or write the manufacturer.

For additional information on how to plan your system, send \$2 for Delta's guide "Central Dust Collection Systems" to Eugene Sliga, Delta International, 246 Alpha Drive, Pittsburgh, PA 15238. For more information about dust collectors, read "Portable Dust Collectors", *WOOD Magazine*, April '87, page 54. And see a related article, "Make Your Own Hoods To Collect Dust", on page 87 of this issue. 🌳

Produced by Peter J. Stephano with Gene Schnaser
Photographs: Mitch Kezar

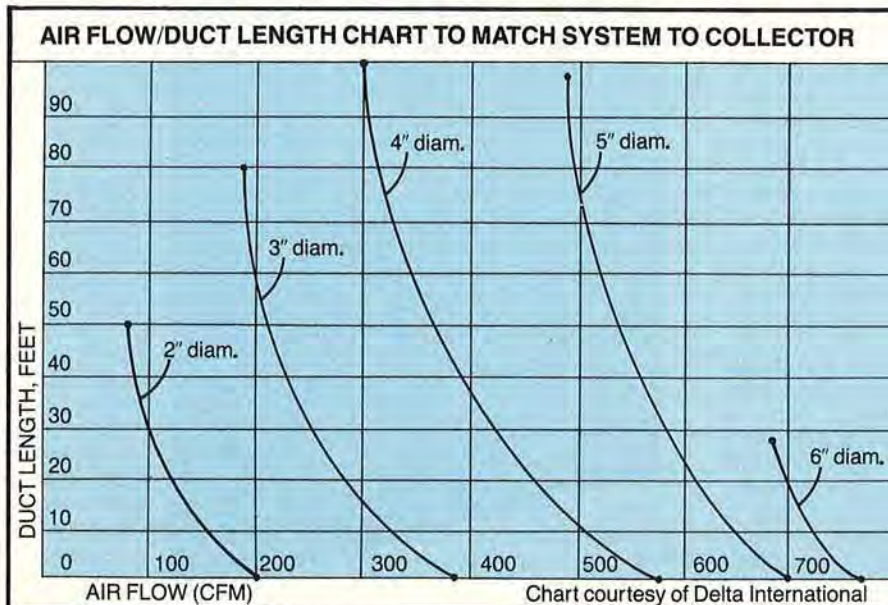

ANOTHER GREAT SHOP ORGANIZER

NOT-SO-PLAIN PLANE RACK

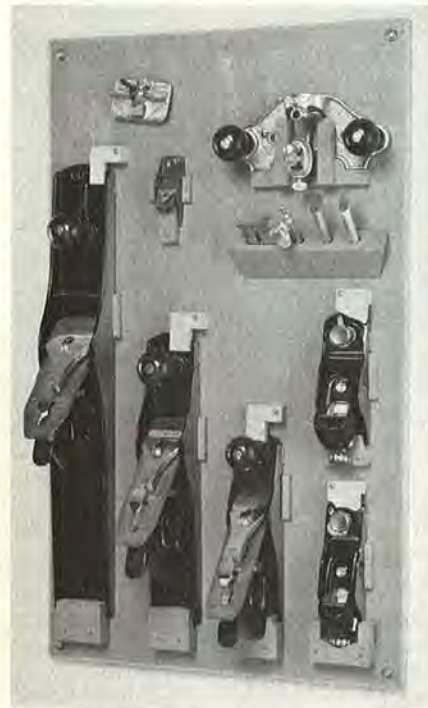

Storing planes on our rack not only keeps them conveniently together, it also safeguards the blades against getting nicked. And, it makes a handsome display as well.

Note: The final size of your plane rack and the position of each plane on it will depend on the size and number you have. Use the photo and drawings of our rack as a guide to build one to suit your needs.

- 1** Cut the backboard (A), trim pieces (B, C), positioners (D), rotating hold-downs (E), and lift pads (F) to size. Cut the heel plates to fit your planes (we formed ours to keep the plane heel from sliding left or right).
- 2** Cut the supports for the router plane and cutters if needed.
- 3** Position your planes on the

backboard and mark the location of the positioners, rotating hold-downs, and heel plates.

4 Drill pilot holes and screw the heel plates to the backboard. Glue the lift pads in position; glue and nail the positioners in place.

5 Paint the backboard assembly and apply a clear finish to the trim and hold-downs. Screw the hold-downs in position, leaving the screws a bit loose so the hold-downs will rotate. Attach the trim.

6 Drill holes through the backboard; fasten rack to the wall.

Project Design: Jim Boelling
Photograph: Bob Calmer
Illustration: Bill Zaun

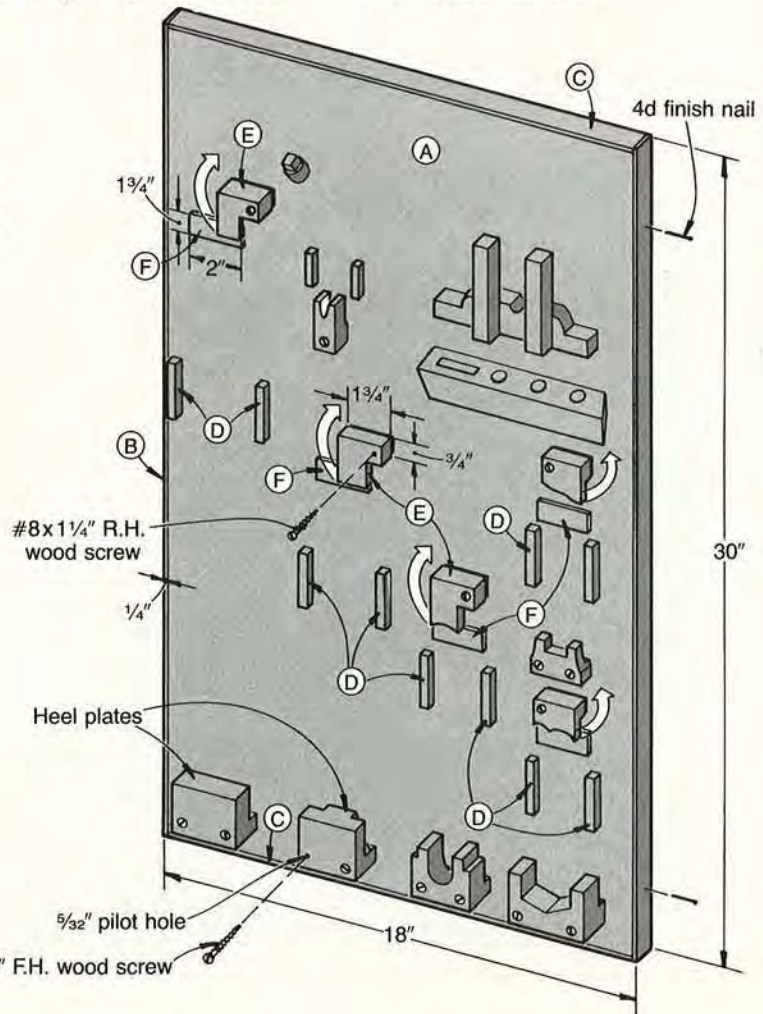
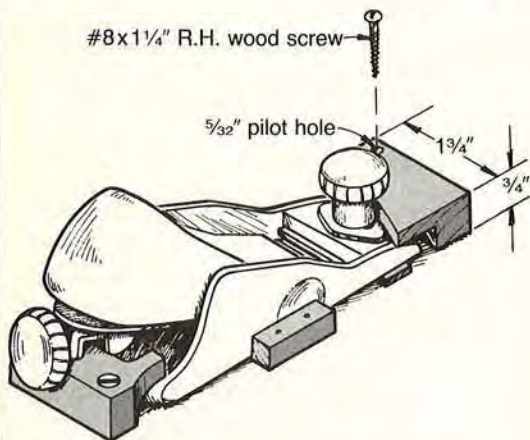

Bill of Materials					
Part	Finished Size			Material	Qty.
	T	W	L		
A	3/4"	17 1/2"	29 1/2"	plywood	1
B	1/4"	3/4"	30"	pine	2
C	1/4"	3/4"	17 1/2"	pine	2
D	3/8"	3/8"	2"	pine	10
E	3/4"	1 3/4"	1 3/4"	pine	3
F	1/4"	3/4"	2"	pine	5

Supplies: #8 x 1 1/4" roundhead wood screws, #8 x 1 1/2" flathead wood screws, 4d finish nails, paint, clear finish.

Issue 9
Feb. 1986



Issue 10
April 1986



Issue 11
June 1986



Issue 12
Aug. 1986

WOOD

I N D E X

Cumulative index for issues 9-16

If you're saving back issues of WOOD magazine for future use, save this index. We've located it in the center of the magazine so you can easily remove it. We've tried to keep the index easy to use, too. For example, after the subject "Block Puzzle" you'll see the numbers, 15:46-47. That simply means you can find the article on pages 46 and 47 of issue 15. And since "Block Puzzle" happens to be a project, you also can find it listed in the special "project index" on page 56.

This listing indexes WOOD issues, 9 through 16. The index for issues 1 through 8 appeared on pages 57-60 of issue number 9 (February, 1986).



Issue 13
Oct. 1986



Issue 14
Dec. 1986



Issue 15
Feb. 1987



Issue 16
April 1987

A-C

Acrylic paints:
carver's finishing techniques, 12:38-41

Air compressors, 10:50-53

Altar, inlaid wood, 9:76

Arbor shaft, homemade, 9:41

Associations:
American Forestry Association, 10:20
Mid-West Tool Collectors Assn., 11:88
Society of Wood Craftsmen, 12:85
U.S. Boomerang Association, 11:28-31

Automobile, Ford "Woodie" restoration, 15:58

Axes, hewing, 13:22, 24

Band saws: See Saws

Bank, "Big Apple," 15:48-49

Bar stool, standard measurements, 9:56

Baskets, 16:60

Basswood, 9:35

Beech, 12:27

Bins, sandpaper storage, 12:72

Birdhouses, wren house, 10:68-69

Bits: drill bits, boring tools, 11:54-55
cabinet organizer, 16:47

Black walnut, cabinet, 9:96, 99

Blades, band saw, unfolding, 9:14

Block Puzzle, 15:46-47

Boats, "Boatbuilders of the Chesapeake," 13:90, 93

Bookends:
bunny, 12:74, 76
train-tunnel, 16:80-83

Boomerangs, 11:28-31

Boring tools, drill bits, 11:54-55

Bowls:
blanks and burls, turned, 14:56-57

Bowls: Cont.
laminated, 14:44-45
pink ivory, covered, 9:77

Boxes:
bread, roll-top, 16:61
dominoes, 11:44-45, 77
dovetail storage, 13:54
jewelry, spalted maple, 12:50
miter, 11:56-57
zebra wood, 9:70-71

Buymanship:
band saws, 15:50-55
drill bits, boring tools, 11:54-55
drivers/drills, cordless, 11:38-43
dust collectors, 16:54-59
Flecto's Varathane finisher, 11:58-59
Japanese hand tools, 9:53
lathe chucks, 14:103, 104, 106
plastic laminates, 10:76-77
power miter saws, 12:52-57
screws, 11:46-49
stock estimates, 10:22
thickness machines, 13:56-61
turning tools, 14:58-60, 83
waterstones, 10:46-47
woodworking videos, 10:89-91

Cabinets:
The Cabinetmaker, 9:96, 99
drill bits, wall-mounted organizer, 16:47
Hargis; cabinetmakers, 14:34-37
kitchen cabinets, standards, 13:64-67
metal, for multi-use sander, 9:40-45, 84-85
sander, wall-mounted organizer, 16:43
spice, oak, 15:76-79, 85

Canisters, kitchen, with brass scoop, 15:72-75

Carts, patio wagon, 11:32-37

Carving:
basswood, 9:35
finishing techniques, 12:38-41
wildlife figures, 10:26-29

Cedar, eastern red, 13:31

Center finder, homemade, 9:38-39

Chairs:
oak dining, 10:40-45
standard measurements, 9:54-56
"Tale of Two Chairmakers," 11:22-23

Chessboard, ebony and satinwood, 15:59

Chests:
cedar, 12:50-51
oak and cedar, heirloom, 13:46-51

Children's items:
airplane, 10:70-72, 75
bank, "Big Apple," 15:48-49
birdhouse, 10:68-69
bookends, bunny, 12:74, 76
chickens pecking, 14:51, 85
climbing bear, 14:50-51
dragster, rubber band-powered, 16:84
flapjack, 14:48-49
play structure, 11:60-66
rocking horses:
carved, 13:54-55
tole painted, 14:62-65
see saw, 14:50-51
spindle top, 14:48, 84
table and chairs, 13:74-78
tow truck, 12:42-47
train set, wood, 14:74-79
whimmydiddle, 14:48-49
whirligigs, wind toys, 16:38-41

Chisels:
sharpening, 11:67-73
wood turning, basics, 14:58-60, 85

Chisels: Cont.
woodworking, Japanese, 9:50-53

Christmas items, sawdust firestarters, 14:26

Clamps:
parallel, tightening, 9:104-105
rack, overhead, 16:45

Chairs:
grandfather, 16:60
interpolated, 10:48
mantel, art deco, 9:81
see-through pendulum, 9:79-80
wall, Angelfish, 9:82

Coffee tables:
butcher-block-style, 15:59
Parsons table, 10:35-39
standard measurements, 9:63

Compressors, See Air Compressor

Containers, candy, covered, 14:46-47

Cordless, See Power Tools

Crafts fairs, 15:62-63, 86-87

Craftsman Close-ups:
boomerangs: Chet Snouffer, 11:28-31
cabinets: Clarence, Melvin, and David Hargis, 14:34-37
figure carving:
Michelle Feasel, 10:26-29
period reproductions:
Ken Williamson, 13:32-35
sculptor/woodworker/teacher: Don Mostrom, 12:28-31
sign cutting: Dave Jordan, 15:36-39
whirligigs: Andy Lunde, 16:38-41
wood turning:
Bert Thompson, 9:36-39

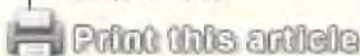

Continued



Palm-sized shakers
Issue 15, p. 60

Band saws
Issue 15, p. 50



Polymerized tung oil
Issue 14, p. 52

Faceplate turning
Issue 14, p. 38



Curves:

circles, arcs, duplicates,
cutting with a band saw,
15:40-45

D-F

Dadoes, router straightedge,
15:56-57
Decoys, duck, 9:77
Desk, cherry rolltop, 15:58
Dinette chair, standard
measurements, 9:55
Dining chair, standard
measurements, 9:55
Display case, Honduras
mahogany, glass, 9:76
Dominoes, 11:44-45, 77
Doors, stained glass, 10:49
Drills and drilling:
bits: boring tools, 11:54-55
cabinet organizer, 16:47
drivers/drills, cordless,
11:38-43
multi-machine, drill chuck
attachment, 10:64-65,
80-81
press counterweight,
12:86-87
safety, 11:87
Drivers, drills/screwdriver,
cordless, 11:38-43
Drop-leaf table, extension
table, standards, 9:63
Dust collectors, basics,
16:54-59
Eagle, carved, 10:49
Earrings, laminated, 14:72-73
Easy chair, standard
measurements, 9:56
Ebony, persimmons, 12:18
Education, 16:70-73
End tables:
cube, 10:88
standard measurements, 9:63
Finishes: finishing and
refinishing:
aniline dyes, 16:48-49
carver's techniques, 12:38-41
Flecto's Varathane, one-day,
11:58-59
polymerized tung oil,
14:52-53
stripping, chemical and
non-chemical, 9:72-75,
88-89
Furniture, woodworker's guide,
16:50-53

G-I

Gauges, center finder,
homemade, 9:38-39
Gouges, wood-turning, basics,
14:58-60, 85
Green wood seasoning:
air-drying, 15:64-67
PEG treatments, 9:46-49
Grinders:
hollow-grind sharpening jig,
11:67-73
multi-machine, 8-speed
sander/grinder with
table, part 1, 9:40-45,
84-85
multi-machine, 8-speed
sander/grinder with
table, part 2, 10:64-65,
80-81
Hammers, Japanese traditional,
9:50-53
Hand tools: *See also:*
*Homemade tools; Power
tools; Tools*
bow saw, 16:93
faceplate turning, 14:38-43
hand screws, tightening,
9:104-105
hewing axes, 13:22, 24
measuring, layout, 11:85
old, preservation, 12:48-49, 82
planes, 16:112
Stanley no. 45, plow/plane,
14:28
turning tools, basics,
14:58-60, 85
waterstones, 10:46-47
woodworking, Japanese,
9:50-53
Hardwoods:
timber, stumpage, selection,
11:50-53
milling, 12:58-63
Hollow-grind, jig, 11:67-73
Holly, 14:33
Homebound training, disabled,
woodworking, 12:28-31
Homemade tools: *See also*
Hand tools, Power tools;
Tools
center finder, 9:38-39
drum-sanding table,
13:52-53, 81
gouges, wood-turning, 9:38
hollow-grind sharpening jig,
11:67-73

Homemade tools: Cont.

lathe, 16:62-69
miter box, 11:56-57
mortise-and-tenon jig,
13:38-39
multi-machine, 8-speed
sander/grinder with table,
part 1, 9:40-45, 84-85
multi-machine, 8-speed
sander/grinder with table,
part 2, 10:64-65, 80-81
router straightedge, 15:56-57
scroll saw, 12:32-37
table-saw extensions with
built-in router table,
12:64-67

J-M

Jewelry:
boxes: spalted maple, 12:50
West African zebrawood,
9:70-71
case, walnut, 13:68-73
earrings, laminated, 14:72-73
stickpin, sweetheart, 14:80
Jigs, hollow-grind sharpening,
11:67-73
Jigsaws: *See* Saws
Joints and joining:
edge-joining with pipe
clamps, 16:103
mortise-and-tenon: joinery,
13:36-41, 82-83
router straightedge,
technique, 15:56-57
"Tale of Two Chairmakers,"
11:22-23
Laminates, laminating:
choosing and buying,
10:76-77
cube end table, 10:88
Parsons table, 10:36-39
plastic, application, 10:30-35
veneer, 9:79-80
Lathes and lathe work:
faceplate turning, basics,
14:38-43
homemade, 16:62-69
lathe chucks, 14:103, 104, 106
tool board organizer, 16:46
wood-turning, techniques,
tools, 9:37-39
Levels, 11:85
Lighting fixtures:
exterior redwood lantern,
10:58-61
walnut ceiling, 10:58-63

Linden, *See* Basswood
Linseed oil, clarified, protective
finish, 12:48-49, 82
Magnets, parrot, 12:73
Marking gauges, 11:85
Mills and milling:
saw, basic operations,
12:58-63
thicknessing machines,
13:56-61
water, basic operations,
12:79-80
Miterers:
box, homemade, 11:56-57
saws, power, 12:52-57
Mortise-and-tenon jig,
homemade, 13:38-39

N-P

Nightstand, classic cherry,
16:74-79
Old Hand Ways:
(Roy Underhill)
"Boatbuilders of the
Chesapeake," 13:90-93
The Cabinetmaker, 9:96, 99
The Gunsmith, 16:101
The Millwright, 12:79-80
"Tale of Two Chairmakers,"
11:22-23
Osage orange, 13:29
Outdoor furniture:
lounge, standard
measurements, 9:56
patio wagon, serving cart,
11:32-37
Parting tool, wood turning,
14:58-60, 85
Pedestal table, rectangular,
standard measurements,
9:62
Pencils, homemade, 16:61
Pine, ponderosa, 11:27
Planes and planing:
hand, 16:112
Japanese traditional, 9:50-53
scrub, homemade, 13:55
Stanley no. 45, plow/plane,
14:28
Plant pedestals, 10:87
Polyethylene glycol (PEG),
9:46-49
Ponderosa pine, 11:27
Power tools: *See also:*
*Hand tools, Homemade
tools, Tools*
air compressors, 10:50-53



Dominoes
Issue 11, p. 44

Logs to lumber
Issue 12, p. 58



Jewelry case
Issue 13, p. 68

Thickening machines
Issue 13, p. 56



Power tools: Cont.

- drill bits, boring tools, 11:54-55
- drivers/drills, cordless, 11:38-43
- dust collectors, basics, 16:54-59
- hollow-grind sharpening jig, 11:67-73
- lathe, homemade, 16:62-69
- miter saws, 12:52-57
- mortise-and-tenon jig, 13:36-41
- multi-machine, 8-speed sander/grinder with table, part 1, 9:40-45, 84-85
- multi-machine, 8-speed sander/grinder with table, part 2, 10:64-65, 80-81
- router, straightedge, 15:56-57
- safety: drilling, 11:87
- saws, band saw buymanship, 15:50-51
- scroll saw, homemade, 12:32-37
- table-saw extensions with built-in router table, 12:64-67
- thickening machines, 13:56-61

R-S

Racks:

- clamp overhead, 16:85
- magazine, oak, 14:66-69
- mug/coat, pine, 13:62-63, 84
- paper towel, wall, 15:80-82
- pie, red oak reproduction, 12:51
- quilt, oak, 15:68-71
- tie, 12:71

Routers:

- bits, vocabulary, 16:30
- freehand sign cutting, redwood, 15:36-39
- organizer, wall-mounted, 16:44
- straightedge, homemade, 15:56-57
- table-saw extensions with built-in router table, 12:64-67

Safety:

- air compressors, 10:53
- chemical strippers, 9:75
- drilling, 11:87
- woodworking with children, 10:67

Sanders and sanding:

- cabinet, wall-hung, 16:43
- drum-sanding table, 13:52-53, 81
- multi-machine, 8-speed sander/grinder with table, part 1, 9:40-45, 84-85
- multi-machine, 8-speed sander/grinder with table, part 2, 10:64-65, 80-81

Sanding block, 14:70-71

Sawdust:

- collecting machines, 16:54-59
- firestarters, 14:26

Sawmills: See Mills and milling

Saws and sawing:

- band sawn; block puzzle, 15:46-47
- band saws, blade unfolding, 9:14
- buymanship, 15:50-55
- bow, 16:93
- carving a blank, 14:24
- cutting curves, 15:40-45
- Japanese traditional, 9:50-53
- power miter, 12:52-57
- radial arm, work center, 10:54-57
- scroll saw, homemade, 12:32-37
- table saw, 10:54-57
- table saw extensions, with built-in router table, 12:64-67

Scoop, brass, 15:75

Scrapers, wood turning, basics, 14:58-60, 85

Screwdrivers, driver/drills, cordless, 11:38-43

Screws:

- handscrews, tightening, 9:104-105
- standards, woodworking, 11:46-49

Scroll saws: See Saws

Sculptor, woodworker/teacher: Don Mostrom, 12:28-31

Seating, standard measurements, 9:54-56

Selling, crafts fairs, 15:62-63, 86-87

options to craft fairs, 15:104-105

Shakers, palm-sized, 15:60-61

Sharpening:

- hollow-grind jig, 11:67-73
- waterstones, 10:46-47

Sharpening: Cont.

- wetstone, homemade multi-use, 9:40-45, 84-85
- Shelves, pine, 13:55
- Shop geometry, 14:54-55, 97
- Sign cutting, 15:36-39
- Sofa, standard measurements, 9:56
- Sofa table, standard measurements, 9:63
- Staining: *See Finishes*
- Standards of measurement: kitchen cabinets, 13:64-67
- screws, 11:46-49
- seating, 9:54-56
- tables, 9:61-63
- tools of, 11:85
- Stripping: *See Finishes*
- Surfacing materials: laminates and solid colors, 10:30-35
- Solicore®, solid-color, 10:87

T-Z

Tables:

- butcher-block-style coffee, 15:59
- end, cube, 10:88
- marble top, 10:48
- oak, expandable dining, 9:64-69, 87
- Parsons, 10:36-39
- standards, 9:61-63

Table saws: See Saws

Techniques:

- approach differences, 14:27
- aniline dyes, 16:48-49
- board dividing/ripping, 15:98
- carver's, finishing, 12:38-41
- cutting curves, band saw, 15:40-45
- dadoes/edge-joining with, 15:56-57
- edge-joining with pipe clamps, 16:103
- faceplate turning, 14:38-43
- freehand router, sign making, 15:35-39
- furniture stripping, 9:72-75, 88-89
- hand planes, 16:112
- hand screw tightening, 9:104-105
- hollow-grind sharpening, 11:67-73
- lefties, tips for, 16:104
- measurements, accuracy, 9:95

Techniques: Cont.

- mortise-and-tenon joinery, 13:36-41
- PEG wood treatments, 9:46-49
- plastic laminates, 10:30-35
- polymerized tung oil, 14:52-53
- router straightedge, 15:56-57
- screws, 11:46-49
- seasoning green wood; air drying, 15:64-67
- PEG wood treatments, 9:46-49
- sign cutting, 15:36-39
- wood finishing, Flecto's, 11:58-59
- wood milling, 12:58-63
- wood turning, 9:37-39
- woodworking, from Hargis, 14:37
- Thickening machines, basics, 13:56-61
- Tools: *See Hand Tools; Homemade Tools; Power Tools*
- faceplate turning, basics, 14:38-43
- measuring, layout, 11:85
- old, preservation, 12:48-49, 82
- organizers, 16:42-47
- scroll saw, homemade, 12:32-37
- Stanley no. 45, plow/plane, 14:28
- wood-turning tools, basics, 14:58-60, 85
- Toys:
 - airplane, 10:70-72, 75
 - bank, "Big Apple," 15:48-49
 - block puzzle, 15:46-47
 - boomerangs, 11:28-31
 - chickens pecking, 14:51, 85
 - climbing bear, 14:50-51
 - dominoes, 11:44-45, 77
 - dragster, rubber band-powered, 16:84
 - flap jack, 14:48-49
 - rocking horses:
 - carved, 13:54-55
 - tole painted, 14:62-65
 - see saw, 14:50-51
 - spindle top, 14:48, 84
 - tow truck, 12:42-47
 - train set, wood, 14:74-79
 - train-tunnel bookends, 16:80-83

Continued



Laminated bowls
Issue 14, p. 44

Heirloom chest
Issue 13, p. 46



Breakfast tray
Issue 12, p. 68

"Big Apple" bank
Issue 15, p. 48



Toys: Cont.
whimmydiddle, 14:48-49
whirligigs, wind toys, 16:38-41
workshop, homebound training for disabled, 12:28-31

Trays, oak, breakfast, 12:68-70

Trees:
ash, 10:25
beech, 12:27
black walnut, 9:96, 99
bristlecone pine, 9:86
eastern red cedar, 13:31
ebony, 12:18
elm, 16:37
hardwood stumpage selection, 11:50-53
holly, 14:33
mesquite, 15:23
osage orange, 13:29
ponderosa pine, 11:27
yellow poplar, 15:35
yew, 16:25

Tung oil, finish, polymerized, 14:52-53

Turning: See Wood-turning

Vases:
laminated weed pot, 11:74
segmented, turned, 12:51

Videos, woodworking, 10:89-91

Waterstones, 10:46-47

Wood:
figured, 13:42-45
figure facts, 13:89
finding wood treasures, 13:86, 87
milling, 12:58-63
PEG treatments, 9:46-49
seasoning; air drying, 15:64-67
timber, stumpage, 11:50-53

Wood lathes, operation and techniques, 9:37-39

Wood species:
ash, 10:25
basswood, 9:35
beech, 12:27
bristlecone pine, 9:86
eastern red cedar, 13:31
ebony, 12:18
elm, 16:37
holly, 14:33
mesquite, 15:23
osage orange, 13:29
ponderosa pine, 11:27

Wood species: Cont.
yellow poplar, 15:35
yew, 16:25

Wood turning:
bowl blanks and burls, 14:56-57
faceplate, 14:38-43
lathe chucks, 14:103, 104, 106
professional production: Bert Thompson, 9:37-39
tools, basic, 14:58-60, 85
tools and techniques, 9:37-39

Wood scraps:
laminated weed pot, 11:74
finding wood treasures, 13:86, 88

Wood words, 15:91, 94

Woodworking:
guide to classic furniture, 16:50-53
hand screw tightening, 9:104-105
homebound training, disabled, 12:28-31
PEG, green wood seasoning, 9:46-49
period reproductions, 13:32-35
plastic laminates, 10:30-35
shop geometry, 14:54-55, 97
standards: estimating stock: Jim Boelling, 10:22
kitchen cabinets, 13:64-67
measurements: Jim Boelling, 9:95
measuring tools: Jim Boelling, 11:85
seating, 9:54-56
screws, 11:46-49
tables, 9:61-63
terminology: 15:91, 94
router bit, 16:30
tips for lefties, 16:104
videos, 10:89-91
with children, 10:66-67
workshops, vacations, 16:70-73

Workshops:
cleaning, organizing, 12:93
home, planning, 10:54-57
Homebound training, disabled, 12:28-31
organizers, 16:42-47
vacations, 16:70-73

PROJECT INDEX

Bank, "Big Apple," 15:48-49
Bins, sandpaper storage, 12:72
Birdhouses, wren house, 10:68-69
Block puzzle, 15:46-47
Bookends:
bunny, 12:74, 76
train-tunnel, 16:80-83
Boomerangs, 11:28-31
Bowls: turned, 14:56-57
zebra wood, 9:70-71
Cabinets:
drill bit, wall-mounted organizer, 16:47
sander, wall-mounted organizer, 16:43
spice, oak, 15:76-79, 85
Canisters, kitchen, with brass scoop, 15:72-75
Center finder, 9:38-39
Chairs: oak dining, 10:40-45
Chests: oak and cedar, heirloom, 13:46-51
Children's items:
dragster, rubber band-powered, 16:84
play structure, 11:60-66
rocking horse, tole painted, 14:62-65
table and chairs, 13:74-78
tow truck, 12:42-47
train set, wood, 14:74-79
Clamps, rack overhead organizer, 16:45
Clocks:
see-through pendulum, 9:79-80
wall, Angelfish, 9:82
Containers, candy, covered, 14:46-47
Dominoes, 11:44-45, 77
Dragster, rubber band-powered, 16:84
Drills and drilling:
bit cabinet, wall-mounted organizer, 16:47
press counterweight, 12:86-87
Earrings, laminated, 14:72-73
Hollow-grind, jig, 11:67-73
Jewelry:
box, West African zebra wood, 9:70-71
ase, walnut, 13:68-73
Lathe:
homemade, 16:62-69
tool board organizer, 16:46
Lighting fixtures:
exterior redwood lantern, 10:58-61
walnut ceiling, 10:58-63
Magnets, parrot, 12:73
Miter: box, homemade, 11:56-57
Mortise-and-tenon jig, homemade, 13:38-39
Nightstand, classic cherry, 16:74-79
Outdoor furniture: patio wagon, serving cart, 11:32-37
Plant pedestals, 10:87
Racks:
clamp organizer, overhead, 16:45
mug/coat, pine, 13:62-63, 84
paper towel, wall, 15:80-82
quilt, oak, 15:68-71
tie, 12:71
Router organizer, wall-mounted, 16:44
Router straightedge, 15:56-57
Sanders and sanding:
cabinet organizer, wall-mounted, 16:43
multi-machine, 8-speed sander/grinder with table, part 1, 9:40-45, 84-85
multi-machine, 8-speed sander/grinder with table, part 2, 10:64-65, 80-81
Sanding block, 14:70-71
Sawdust, firestarters, 14:26
Saws and sawing:
band saw: table extension, 15:42-43
carving a blank, 14:24
table saw extensions with built-in router table, 12:64-67
Scoop, brass, 15:75
Shakers, palm-sized, 15:60-61
Signs, freehand router cutting, 15:39
Tables:
end, cube, 10:88
oak, expandable dining, 9:64-69, 87
Parsons, 10:36-39
Toys:
airplane, 10:70-72, 75
chickens pecking, 14:51, 85
climbing bear, 14:50-51
flapjack, 14:48-49
see saw, 14:50-51
spindle top, 14:48, 84
whimmydiddle, 14:48-49
Train-tunnel bookends, 16:80-83
Trays, oak, breakfast, 12:68-70
Vases, laminated weed pot, 11:74
Whirligig, woodworker wind toy, 16:40-41
Workshops:
home, planning, 10:54-57
organizers, 16:42-47
Compiled by Eugenia F. Slone

DRUM-SANDER HOLDER

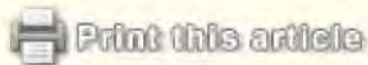

Tired of sanding drums and sleeves rolling around your shop — or worse yet, not being able to find them? Solve the problem in a hurry with our wall-mounted holder. The drum shafts fit in holes in the top, and there's plenty of room below for the sanding drum sleeves.

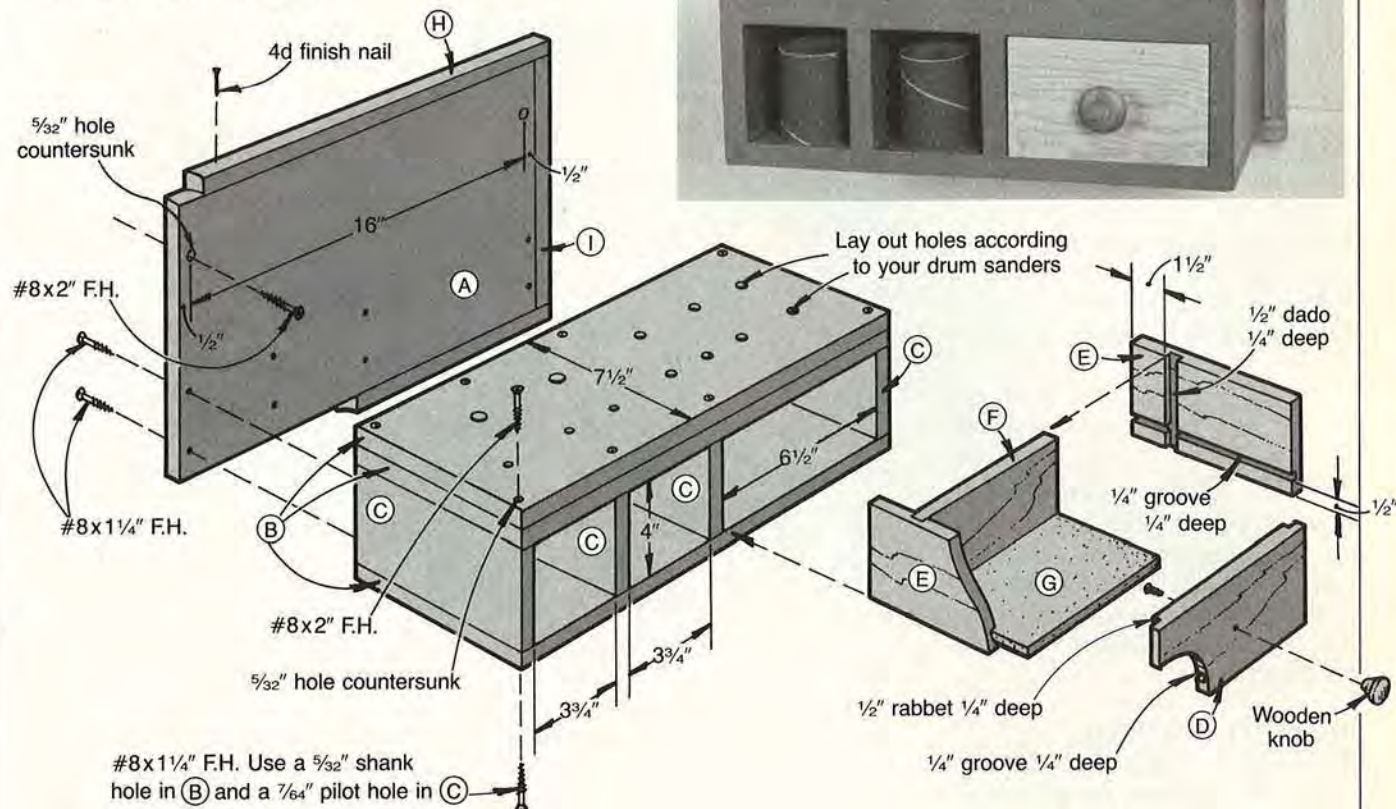

Bill of Materials					
Part	Finished Size			Material	Qty.
	T	W	L		
A	3/4"	11"	17"	particle-board	1
B	3/4"	7 1/2"	17"	particle-board	3
C	3/4"	4"	7 1/2"	particle-board	4
D	1/2"	3 15/16"	6 7/16"	pine	1
E	1/2"	3 15/16"	7 1/4"	pine	2
F	1/2"	3 3/16"	5 15/16"	pine	1
G	1/4"	5 15/16"	7 1/4"	hardboard	1
H	3/4"	3/4"	18 1/2"	pine	2
I	3/4"	3/4"	11"	pine	2

Supplies: #8x1 1/4" flathead wood screws, #8x2" flathead wood screws, wooden knob, 4d finish nails, masking tape, paint

- 1 Cut the back (A), storage box tops and bottom (B), and dividers (C) to size. Laminate the two top pieces. Lay out and drill 1"-deep holes in the top to house the shafts of your drum sanders.
- 2 Glue and clamp the storage box together. Drill shank and pilot holes, and drive the screws.
- 3 Cut the drawer front (D), sides (E), back (F), and bottom (G) to size. Cut or rout a 1/4" groove 1/4" deep 1/2" from the bottom in the drawer front and sides. Cut a 1/2" dado 1/4" deep 1 1/2" from the back edge of each side. Finally, cut a 1/2" rabet 1/4" deep along both ends of the front piece.
- 4 Glue and clamp the drawer together, checking for square. Drill

- a hole through the drawer front and attach a knob.
- 5 Cut trim pieces (H, I) to size; glue and nail them to the back (A).
- 6 Glue and clamp the storage box to the back piece. Drill shank and pilot holes from the back side of the back piece into the back of the box, and screw the back to the box.
- 7 Mask off the trim pieces and paint the storage box and back. Remove the masking tape and apply a clear finish to the trim and drawer.
- 8 Drill mounting holes through the back piece, and fasten the holder to your shop wall. 🛠️

Project Design: Bill Lovelace
 Photograph: Bob Calmer
 Illustration: Kim Downing; Bill Zaun

SUNBURST DINING TABLE

As part of my job here at WOOD, I monitor the progress of each project as it goes together in the shop. As I began to see this dinette table take shape, I had a hunch it was going to be a winner. I was surprised, too, that the construction techniques looked very "doable". As it turns out, I was right on both counts. The 48" table fits right in with the rest of the furniture in my house, and my wife loves the matched oak-grain top and the sturdy, walnut-accented base.

Marken Kemmet
How-To Editor

BEGIN WITH THE BASE

Note: You'll need some 1/8" walnut for this project. You can either resaw or plane thicker stock to the correct thickness or special order it. See the Buying Guide on page 60 for our source.

HOW TO CUT AND LAMINATE THE LEGS

- 1 Cut the leg parts (A, B, C) to size plus 1/2" in width and 1" in length from 3/4" oak stock.
- 2 Spread an even coat of glue on the mating surfaces, then clamp eight A-B laminations together as shown in the sketch below. Now,

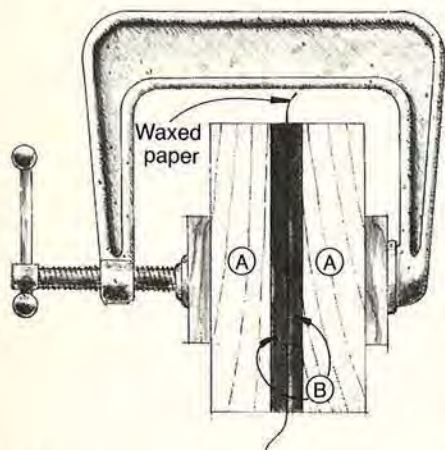

glue and clamp four C-C laminations together for the legs. (We used a 2" disposable paint roller to apply the glue.)

- 3 Plane the oak face of each A-B lamination to reduce the thickness to 3/4". (As shown in the sketch below, we used a push block and push stick, and made several shallow cuts on the jointer to safely plane the lamination to size.)



- 4 Trim the C-C laminations to a finished length of 21". Glue and clamp a C-C lamination centered from end to end between a pair of A-Bs for each of the four legs; make sure the edges are flush.
- 5 After the glue dries, remove the clamps and scrape off the excess glue from one edge of each lamination. Set the table saw fence 3 3/8" from the blade, and with the scraped edge against the fence, rip one edge of each of the four legs. Now, position the table saw fence 3 1/4" from the blade and rip the opposite edge to cut the legs to finished width.
- 6 Finally, crosscut the legs to length so the open mortise on each end of each leg measures 3 1/4" long. Remove any excess glue from the mortises with a sharp chisel.

CUTTING AND LAMINATING THE FEET

- 1 To cut and laminate the feet (D, E, F), use the same procedure

outlined in steps 1, 2, and 3 of the previous section.

- 2 Now, trim one end of the four F-F laminations square. Glue and clamp each of them between a pair of D-E laminations, with the D-E laminations flush with each other and 3 1/4" from the squared end of the F's as shown below.

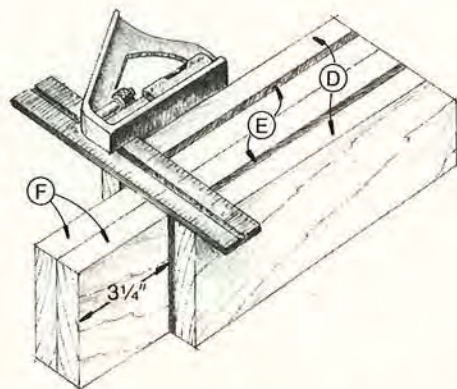

- 3 Again, using the two-step ripping procedure used on the legs (see step 5 of the previous section), rip the feet to width (3 1/4"). Crosscut the feet to length (12"). Remove any excess glue from the tenons.
- 4 Cut the large chamfer on the end of each leg (we cut ours on the radial arm saw).

FORMING THE CROSSMEMBERS AND TABLETOP SUPPORT

- 1 Cut the outside crossmember parts (G) to size plus 1/2" in width, and cut the inside parts (H) to size plus 1/2" in width and 1" in length.
- 2 Glue and clamp the two H-H laminations together. Later, trim both ends of both laminations for a finished length of 18 1/2".
- 3 Glue and clamp an H-H lamination between two G's for each crossmember. Keep the ends of the two outer pieces flush with each other, using the same squaring technique used with the feet (see step 2 of the previous section).



Sit back and enjoy the feast and festivities on the matched-grain oak table supported by the attractive walnut-stripped base. Simply lay out the pattern on plywood, then cut the parts with your router.

4 Cut a 3"-wide notch 1½" deep centered along the length of each crossmember where shown on the Exploded-View Drawing.

5 Cut the support pieces (I, J) to size. Cut or rout a 45° chamfer on both ends of I and on one end of each J. Put the support pieces aside for now; you'll use them later.

NOW, ASSEMBLE THE BASE

1 Glue and clamp one foot to each leg, checking for square.

2 Glue and clamp two legs to one of the crossmembers, making sure the notch faces *up*, again checking

for square. Repeat with the other two legs and crossmember, making sure the notch faces *down*.

3 Interlock the two notched crossmembers, and glue and clamp the two leg assemblies together to form the base.

4 Center and clamp the tabletop support pieces to the top of the oak base. To mount the supports to the base, drill screw holes from the top side of the support pieces to the sizes noted on the Exploded-View Drawing. Then, screw the supports to the base assembly with wood screws.

BUILDING THE TOP

Note: The following routing procedures used to rout the plywood top and oak band require sharp carbide-tipped bits. Make several passes, lowering the bit no more than ¼" per pass to make the cuts. See the Buying Guide on page 60 for our source of router bits.

FORMING THE PLYWOOD TOP

1 Start by cutting a sheet of 4x8' oak veneer plywood in half where shown in Step 1 on the Cutting Diagram.

DINING TABLE

Cutting Diagram

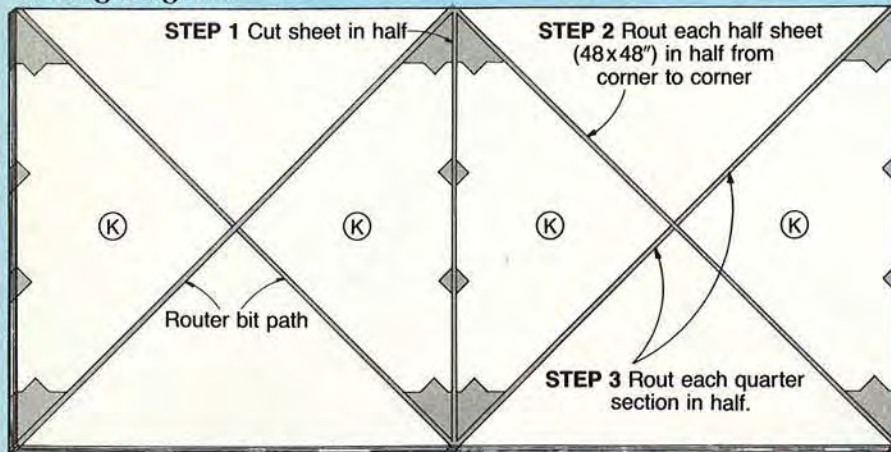

$\frac{3}{4}$ x 48 x 96" Oak Plywood

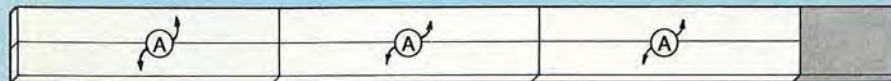

$\frac{3}{4}$ x 7 1/2 x 96" Oak

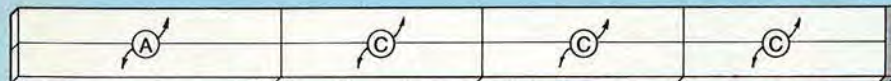

$\frac{3}{4}$ x 7 1/2 x 96" Oak

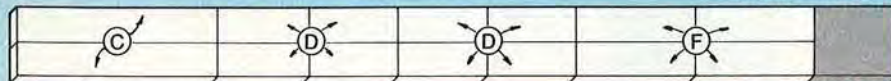

$\frac{3}{4}$ x 7 1/2 x 96" Oak

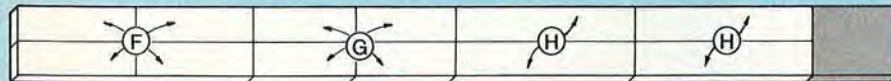

$\frac{3}{4}$ x 7 1/2 x 96" Oak



2 pieces— $\frac{3}{4}$ x 5 1/2 x 96" Oak



2 pieces— $\frac{3}{4}$ x 5 1/2 x 96" Oak

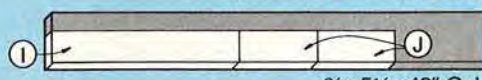

$\frac{3}{4}$ x 5 1/2 x 48" Oak

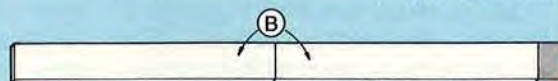

4 pieces— $\frac{1}{8}$ x 3 3/4 x 60" Walnut*

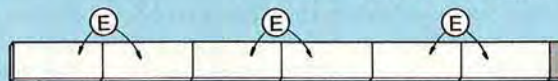

$\frac{1}{8}$ x 3 3/4 x 60" Walnut*



$\frac{1}{8}$ x 3 3/4 x 60" Walnut*

BUYING GUIDE

● $\frac{1}{8}$ " walnut. For all walnut parts, \$24. Wyndham Woods, P.O. Box 506, Ellettsville, IN 47429, 812/876-4960.

● Router bits. $\frac{1}{4}$ " slot cutter, carbide tipped, cat. no. 10, \$14. 45° chamfer bit, carbide tipped, cat. no. 12, \$15. $\frac{1}{2}$ " straight bit, carbide tipped, cat. no. 27, \$7. MLCS, P.O. Box 53, Rydal, PA 19046, 800/533-9298 (In PA 800/346-7511 ext. 56) to order.

*See Buying Guide at left for our source.

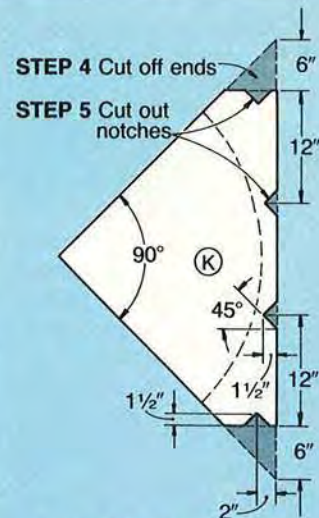

PLYWOOD SECTION (Top view)

Bill of Materials

Part	Finished Size*			Material	Qty.
	T	W	L		
A*	$\frac{3}{4}$ "	$3\frac{1}{4}$ "	$27\frac{1}{2}$ "	oak	8
B*	$\frac{1}{8}$ "	$3\frac{1}{4}$ "	$27\frac{1}{2}$ "	walnut	8
C*	$\frac{3}{4}$ "	$3\frac{1}{4}$ "	21"	oak	8
D*	$\frac{3}{4}$ "	$3\frac{1}{4}$ "	$8\frac{3}{4}$ "	oak	8
E*	$\frac{1}{8}$ "	$3\frac{1}{4}$ "	$8\frac{3}{4}$ "	walnut	8
F*	$\frac{3}{4}$ "	$3\frac{1}{4}$ "	12"	oak	8
G*	$\frac{3}{4}$ "	$3\frac{1}{4}$ "	12"	oak	4
H*	$\frac{3}{4}$ "	$3\frac{1}{4}$ "	$18\frac{1}{2}$ "	oak	4
I	$\frac{3}{4}$ "	$3\frac{1}{2}$ "	$20\frac{1}{2}$ "	oak	1
J	$\frac{3}{4}$ "	$3\frac{1}{2}$ "	$8\frac{1}{2}$ "	oak	2
K*	$\frac{3}{4}$ "	36"	24"	oak plywood	4
L*	$\frac{3}{4}$ "	$5\frac{1}{4}$ "	$20\frac{3}{8}$ "	oak	8
M*	$\frac{3}{4}$ "	$5\frac{1}{4}$ "	$20\frac{3}{8}$ "	oak	8
N*	$\frac{1}{8}$ "	$\frac{3}{4}$ "	$34\frac{1}{16}$ "	walnut	4

*Parts marked with an * are cut larger initially, and then trimmed to finished size. Please read the instructions before cutting.

Supplies: #10 x $\frac{1}{4}$ " flathead wood screws, $\frac{1}{2}$ " dowel stock, 4 — floor glides, stain (if desired), finish

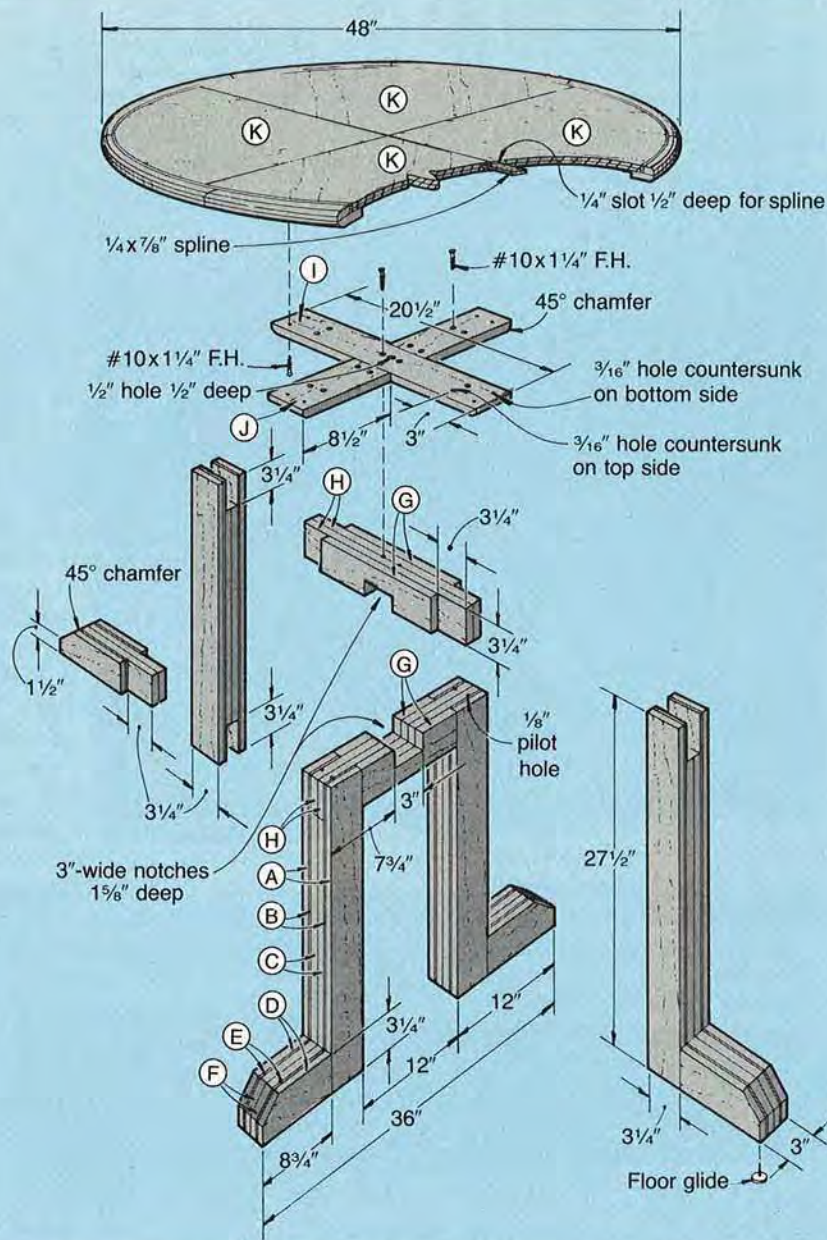

2 Draw a diagonal line on both 4x4' pieces of the oak plywood. (We laid the plywood on a half sheet of particleboard because the last routing cut needs to go into the particleboard about 1/8" for a clean cut through the plywood. Also, routing results in less chipping than if cutting with a saw.) Now, clamp a straight board to the plywood, fit your router with a 1/2" carbide-tipped straight bit, and rout down the center of the marked diagonal to cut both half sheets in half again (see Step 2 on the Cutting Diagram).

3 Reposition your fence and rout the four triangular pieces in half where shown in Step 3 of the Cutting Diagram.

4 Referring to the Plywood-Section Drawing, use a jigsaw to cut off the ends of each plywood section (K) where shown in Step 4. Cut the notches where shown in Step 5 on the drawing.

JOINING THE PLYWOOD PIECES

1 Arrange the four plywood sections (K) to achieve the best grain pattern, and mark the mating edges where shown in Step 1 of the Assembly-Sequence Drawing below. Now, rout a 1/4" slot 1/2" deep along the mating edges of the two adjacent panels where shown in Step 2. Repeat this procedure for the other pair.

2 Cut four 1/4" splines 7/8" wide by 24" long. Check the fit of the splines in the 1/4" grooves.

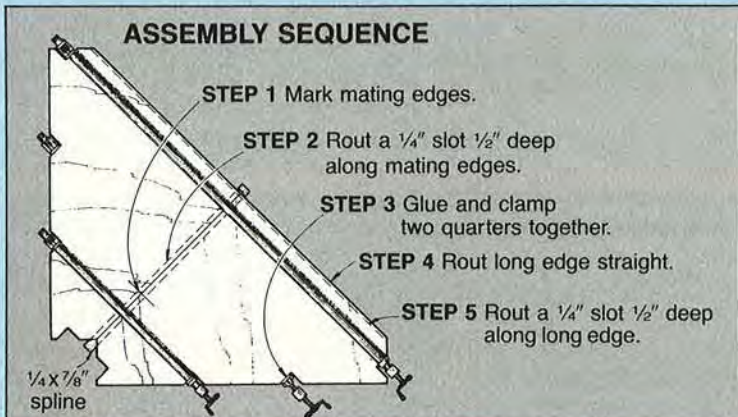

Clamp the two table halves together.

DINING TABLE

3 Glue, spline, and clamp two of the plywood quarter-sections together. Use the notches cut in the plywood to hold the heads of the clamps as shown in Step 3 on the Assembly-Sequence Drawing, alternating the clamps to equalize the pressure. Be *careful* to keep the long edge flush. Glue and clamp the other two pieces.

4 Using a straight board as a fence, a $\frac{1}{2}$ " straight bit, and a backing board on the bottom to prevent routing into your workbench top, rout several shallow passes to trim $\frac{1}{16}$ " off the long edge (Step 4) to ensure a perfectly straight edge. Repeat on the other plywood section.

5 Rout a $\frac{1}{4}$ " slot $\frac{1}{2}$ " deep along the long edge of each half section (Step 5).

6 Glue, spline, and clamp the two halves together as shown in photo A on the previous page. (As you can see in the photo, our notches were not exactly the same as shown on the drawings. When gluing the panels together, we found that a few more notches would have been helpful.)

BUILDING THE SOLID OAK BAND

1 Rip and crosscut 16 pieces of $\frac{3}{4}$ " oak to $5\frac{1}{4}$ " x 21" for the upper band pieces (L) and lower band pieces (M).

2 Miter-cut the ends of each piece at a $22\frac{1}{2}^\circ$ angle for a $20\frac{3}{8}$ " finished length. (We miter-cut eight pieces of equal-length scrap and clamped them together to ensure an accurate angle setting.)

3 Glue and clamp the top band together. (We laid the pieces on waxed paper on a half sheet of particleboard and band-clamped them together. Then, we clamped each band piece to the particleboard to ensure a flat band.) Later, repeat this process for the lower band.

4 Make alignment marks (see the Ring-Assembly Drawing) at the centerline of several of the upper band pieces (L). Position one band on top of the other one, aligning the marked centerlines of the top

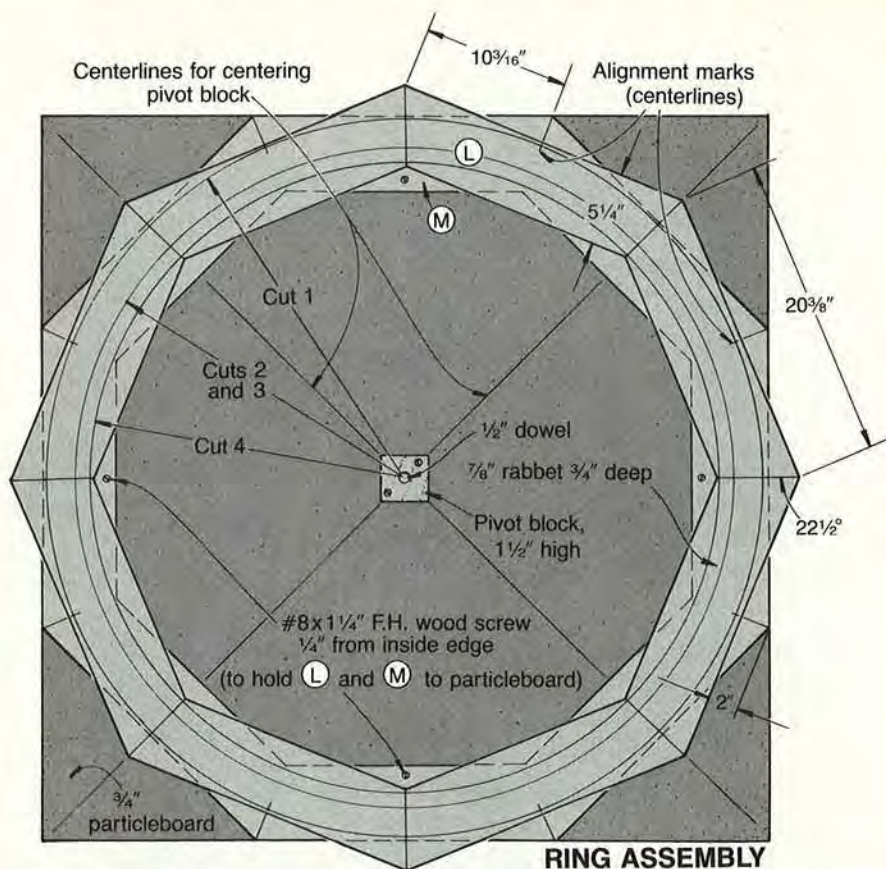

TRAMMEL BASE

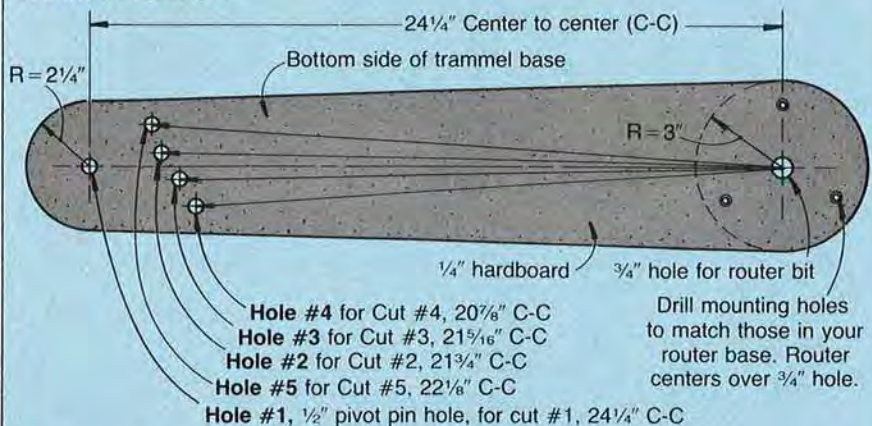

Note: Space holes #2 thru #5 approximately 1" apart C-C

ROUTING SEQUENCE

Note: All routing made in several passes.

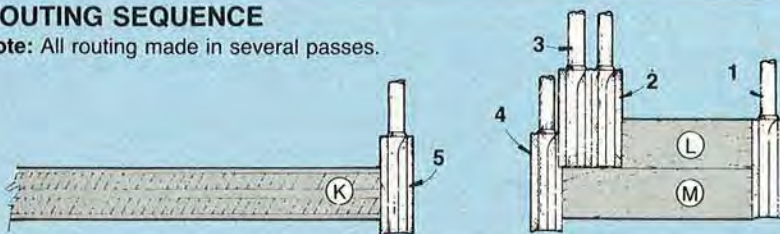



B Apply glue, then align and clamp the two oak bands together.

band pieces with the joint lines of the bottom band. Glue and clamp the bands together as shown in photo B above.

BUILDING THE TRAMMEL BASE AND ROUTING THE OAK BAND ROUND

1 Cut the trammel base to shape, and drill the five pivot-pin holes where dimensioned on the Trammel Base Drawing. Remove the plastic subbase from your router and mount the trammel base in its place.

2 To make the pivot block for the trammel base, cut two pieces of $\frac{3}{4}$ " scrap to 3×3 ". Glue and clamp together, draw diagonals, and drill a $\frac{1}{2}$ " hole through the center of the block.

3 Lay the oak bands on a piece of particleboard with the upper band on top. Then, drill shank and pilot holes through the lower band pieces (L) where shown on the Band-Assembly Drawing. Screw the band to the particleboard.

4 Locate and mark the center of the band on the particleboard (we used a long straightedge to draw lines between the opposite joint lines to find center). Center the hole in the pivot block directly over the center point, and screw the block in position. Glue a 4" length of $\frac{1}{2}$ " dowel in the hole in the block.

5 Chuck a $\frac{1}{2}$ " carbide-tipped straight bit into your router. Position pivot-pin hole #1 on the $\frac{1}{2}$ " dowel in the pivot block. Rout $\frac{1}{4}$ "



C Mount the trammel and rout the laminated-oak band to shape.

deep into the oak band to start forming the outside to shape as shown in photo C above and on the Trammel Base and Routing-Sequence Drawing. Lower the bit about $\frac{3}{16}$ " per pass until you have cut through the band.

6 Using trammel base hole #2 and then #3 on the pivot block, rout the $\frac{7}{8}$ " rabbet $\frac{3}{4}$ " deep where shown on the Trammel-Base and Routing-Sequence Drawing. (We checked the depth of the rabbet on a scrap piece of oak plywood.) Using hole #4, make several passes to cut through the band to form the inside circumference.

7 Remove the band from the particleboard, and rout a chamfer on the top and bottom outside edge of the oak band with a chamfer bit (see the Edge Detail above right).

8 Finally, rout or sand a slight chamfer on the bottom inside edge of the bottom band.

ROUTING THE PLYWOOD TOP

1 Remove the pivot block from the particleboard. Lay the plywood top, good side down, on the particleboard. Drill a $\frac{1}{2}$ " hole $\frac{1}{2}$ " deep at the exact center (where the joint lines converge) of the top. Glue a $\frac{1}{2}$ " dowel 3" long in the hole.

2 Using hole #5 in the trammel base, rout the plywood top to shape, again cutting through the $\frac{3}{4}$ " thickness in several passes. Trim the $\frac{1}{2}$ " dowel so it protrudes $\frac{1}{2}$ "; you'll use the dowel later to center the tabletop on the base.

EDGE DETAIL

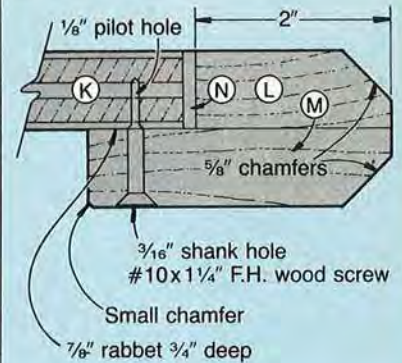

NOW, FINAL ASSEMBLY

1 Center the plywood top in the $\frac{7}{8}$ " rabbet in the oak band. Measure the width of the gap, and cut a 10" scrap test strip to the measured width. Crosscut the strip into four short spacers, and position the plywood to check for a proper fit and to center the plywood. Adjust the width if necessary, and then cut the four walnut strips (N) to $3\frac{3}{16}$ ".

2 Drill shank and pilot holes to the sizes noted in the Edge Detail above, and fasten the oak band to the plywood top.

3 Put glue in the gap and insert the walnut strips. You may need to trim the last strip before insertion for a tight fit.

4 Being extremely careful not to go through the veneer, plane, scrape, and sand the walnut strips flush with the plywood top.

5 Finish-sand the base and tabletop. Stain and finish as desired.

6 Drill a $\frac{1}{2}$ " hole $\frac{1}{2}$ " deep in the center of the tabletop support to align the tabletop with its protruding $\frac{1}{2}$ " dowel.

7 Center the tabletop on the base, and drill shank and pilot holes through the bottom of the supports into the bottom of the tabletop. Counterbore the screws. Attach the tabletop to the base, and attach the floor glides. 🪛

Produced by Marlen Kemmet
Project Design: James R. Downing
Photographs: Bob Calmer
Illustrations: Kim Downing; Bill Zaun

HOW THEY MANUFACTURE ROTARY-

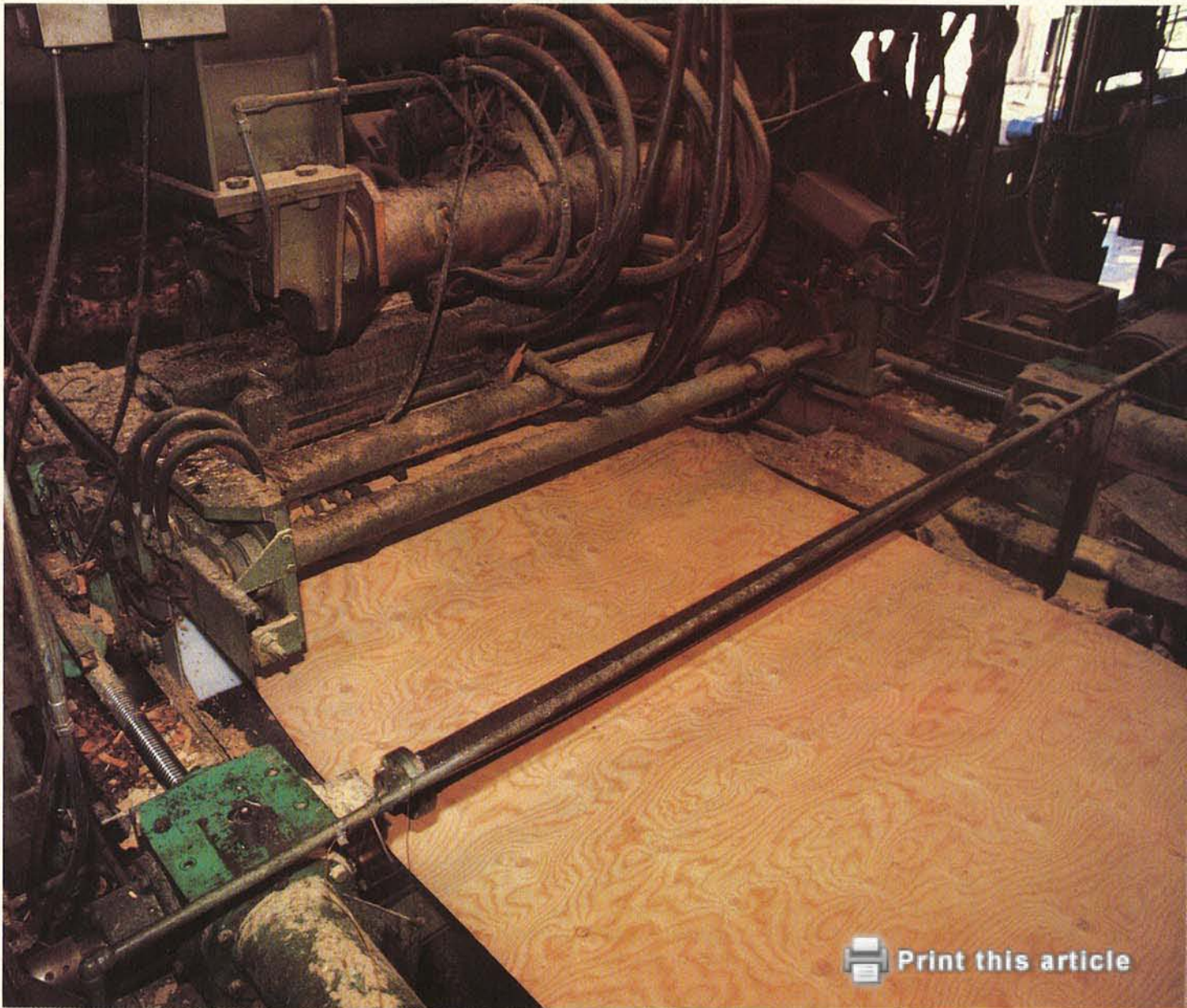

 Print this article

COMMON VENEER CUTTING METHODS, APPEARANCE, AND APPLICATIONS

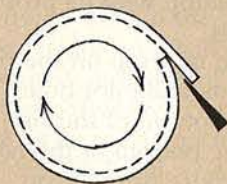

ROTARY METHOD

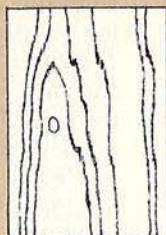

Rotary cut

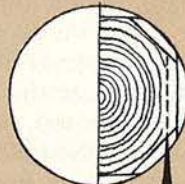

PLAIN OR
FLAT SLICED

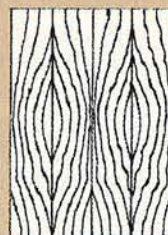

Bookmatch

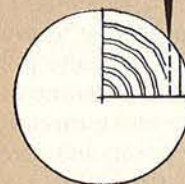

QUARTER CUT

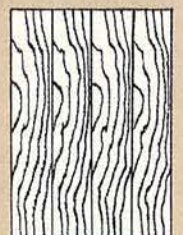

Slipmatched

Rotary-cut veneers — All softwood plywood face and backs, veneer cores, and less-expensive hardwood plywood face and backs.

Plain-sliced (flat-sliced) and quarter-cut veneers — Laid down in pleasing patterns for hardwood plywood face and backs, architectural panels.

CUT SOFTWOOD PLYWOOD

Thin ribbons of rotary-cut veneer, laid up in sheets, make up today's softwood plywood that fills the bill for many projects — from home remodeling to shelving. In this visit to a plywood mill, you'll learn how modern production keeps softwood plywood a strong, versatile, and affordable material.

There's a big difference between softwood plywood and hardwood plywood — besides price. Bruce Haliburton, plywood marketing manager for Georgia-Pacific Lumber Co. in Portland, Oregon sums up the distinction: "Hardwood plywoods have a more pleasing design appearance." And he's right. The thin veneers of cabinet woods such as cherry, oak, maple, pecan, walnut, and other species are specially made. To form the attractive, decorative, and natural patterns on one or both sides of the sheet, the slower plain cut or quarter cut technique will often be used (see diagrams, opposite page). In contrast, the seamless, rotary-cut top ply of a softwood plywood panel looks quite unnatural.

There's a difference, too, in how some hardwood plywood sheets are manufactured. While you'll find softwood plywood normally made with only a veneer core, hardwood plywood may be bought with cores of solid, edge-joined lumber, particleboard, or fiberboard, as shown *below*. Each type of core material has its merits for different applications, but veneer core usually gets the nod for overall strength and versatility. (For comparisons, see "Should You Be Using Hardwood Plywood?" *WOOD Magazine*, Aug. '85, p. 55.)

Despite softwood plywood's ugly-cousin role, this material remains the workhorse of home construction, inexpensive do-it-yourself projects, and yes, even furniture and cabinet making. You'll also find most hardwood plywood constructed with a crossbanded core of rotary-cut, softwood veneers. Glue thin, hardwood veneers to the front and back of a softwood plywood sheet and presto, you've got hardwood plywood!

You'll never find mills far from the trees

Little more than 50 years ago, giant Douglas fir trees towering 300' in

height and up to 17' in diameter made perfect candidates for the raw material of a new industry. Fledgling plywood makers focused on the efficiency of peeling long lengths and widths of wood, rather than sawing it. The wood's tough fibers didn't separate when shaved thin, and the veneers glued easily because they lacked excessive pitch and resins. Today, mills in the Northwest still feed on Douglas fir.

In the southeastern states, however, plywood manufacturing got a much later start. It wasn't until about 25 years ago that the plentiful yellow pine began yielding to the rotary-cutting knife. An adhesive had to first be developed that would hold this highly resinous wood together.

Now, you'll find southern pine plywoods stacked side by side in the marketplace with plywood made of Douglas fir. In fact, some large plywood manufacturers have plants in both parts of the United States. They found it more economically feasible to build plants near the raw material than to freight logs across country.

Plywood begins as logs soaking in the sun

In Idaho's Emmett Valley, smoke billows high into the sky, pinpointing the boiler at Boise Cascade's Emmett plywood plant. It's one of dozens of such facilities in this corner of the nation. Although the valley itself relies on agriculture, the plywood plant thrives on the forests of Douglas fir blanketing the surrounding hills and mountains.

"In this part of Idaho, we get only second-growth fir, timber that has regrown following earlier logging," explains Jack Stevens, assistant plant manager. "Because the stands of trees aren't as dense as the first-growth forests closer to the coast, the trees have many more branches. This translates into more knots. So, we produce strictly lower grade sheets. But no

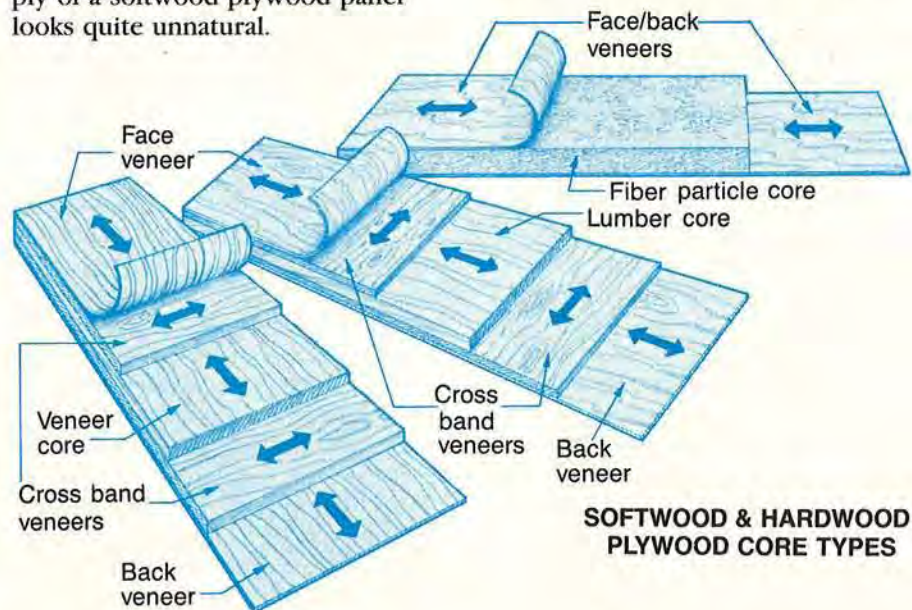

ROTARY-CUT SOFTWOOD PLYWOOD

matter what the veneer quality, all softwood plywood will be made the same way."

In the sprawling acres of mill yard outside the plant, fir logs brought in from miles around make up a giant, seemingly endless woodpile. As the logs bask in the summer sun, sprinklers rain water on them to prevent their drying out and splitting.

Logs actually start their trip through the mill at the debarker. Here, huge claws strip them of bark in seconds. From there, they move to a monstrous, 7'-diameter cutoff saw. Here each log gets trimmed to a routine 103" length. The bark and waste wood removed from the logs fuel the plant's boiler. The skinned and trimmed logs head for the next step — conditioning.

Years ago, logs were soaked in a pond so they would peel easier. Today, they're softened up in a steam room, photo A. Much like a huge shower stall, the steam room engulfs the logs in a spray of hot, 160° F. water for eight hours. During cold Idaho winters, this steaming process also serves to thaw out frozen logs. So, when the temperatures drop, time in the steam room increases.

A computer directs the peeling process

As a log tumbles onto the lathe bed from a conveyor, specialized measuring equipment immediately sizes it and feeds the information to the computer. In turn, the computer locates the log's center points on the ends, then directs its advance to the between-centers position where head and tail stock spurs grab hold. Locked in place, the log begins to spin, awaiting contact with the blade.

Slowly, from his perch far above the plant floor, the lathe operator eases the long cutting blade against the spinning log. At first in contact with only the high points of the log's surface, the blade shears irregularly. But as the log quickly shears to a perfectly cylindrical shape, a continuous unbroken ribbon of 1/8"-thick veneer as wide as the log comes off, opening photo

and B. In less than 60 seconds, nothing remains but the small core, which some mills sell as fence posts (here, they end up as fuel). The yield? An uncut veneer ribbon from a single log stretching up to 200' or longer!

At a large clipping machine down the line, the veneer ribbon gets sliced into manageable-size sheets, or plies, measuring 54x101". Workers sort these plies, as well as smaller "tailing" veneers that will be used for butted-up cross plies, into three categories — heartwood, light sap, and heavy sap. Each category has a different moisture content, so drying times vary. The separated plies will be dried accordingly in the 200'-long dryer which operates at 400° F.

Grading veneers by knotholes

The Hardwood Plywood Manufacturers Association (HPMA) sets the grading standards of hardwood plywood by appearance of face and back veneers. But most softwood plywood falls into the realm of the American Plywood Association (APA). Their grading standards become a knotty affair. (See softwood plywood grading, bottom, next page.)

Since this mill manufactures exclusively unsanded, engineered grade, or construction plywood, the number of knots in each ply, and their size, determine where it will be used. Plies with occasional knots up to 1" diameter become C-grade veneers. Those with larger knots become D-grade veneers, used as core and back plies. Workers quickly learn to spot the difference and sort the sheets into piles by grade, photo C.

Building up plywood along the line

Graded and separated, the plies move to the assembly belt. Along this "lay up" line, a metallic-fingered machine first sets the higher-quality sheets down for the face plies. A layer of an exterior glue comes next, photo D. As the sheets being built up move on down the line, the process

repeats itself for cross plies and the final back ply, photo E. The glue between each ply goes down in streams — like toothpaste — and prompts the assistant plant manager's explanation.

"We call it 'foam glue,'" says Jack. "When it hits the air, it reacts like shaving cream out of a can, foaming and expanding. We mix it right here on the spot."

Pulling out the "recipe," Jack lists the exterior glue's ingredients: water, resin mixed with formaldehyde, caustic soda to penetrate the wood fibers, wheat flour as adhesive and filler, emersol for the foam, and blood. Pointing to the stacked bags of dry animal blood, Jack notes that blood has a tenacious adhesive quality.

A bond stronger than the wood in the plies

To make the bond between the glue and veneers strong enough to stand the rigors of construction, the would-be plywood must be pressed and heated. The plywood press itself rises two stories above the plant's floor, photo F. With 175 psi pressure, it forces the individual veneers of a sheet together, then bakes them at 300° F. for over three minutes. From his platform elevator, the press operator feeds the raw material in between the heated platens and removes the new plywood after baking.

Back on the production line, the plywood moves to the panel saws for trimming to finished size. Finally, the rectangular 4x8' plywood sheets receive a last inspection, then come off the line, as shown in photo G.

Later, in his office, Jack holds out the results of another inspection. Over the only slightly muffled roar of the plant, he says: "These are samples of our plywood we sent to APA for testing. Each has been partially sawn through, then broken apart. Ideally, the plywood shouldn't break on the glue line — the wood fibers should pull apart first. The glue should be as strong or stronger than the wood itself." His samples passed the test.

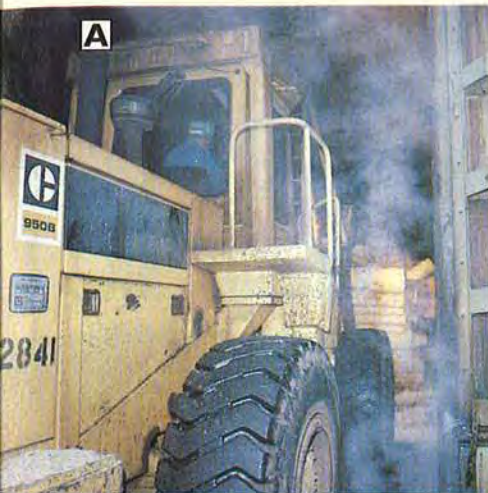

A

Fir logs from the yard get a steam bath to soften them for peeling.



B

The lathe blade reduces log after log to mere fence posts.



C

Fresh from the drying oven, plies get sorted on the roundtable.

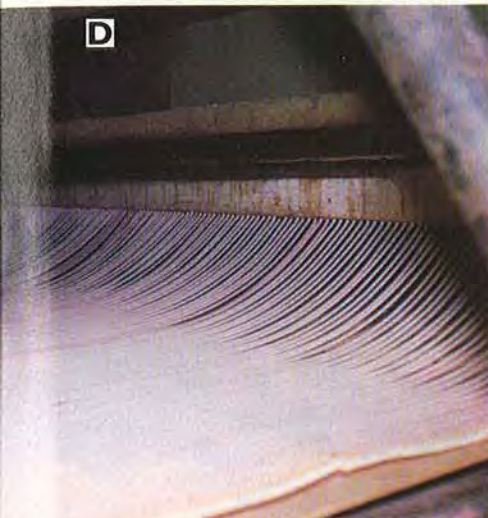

D

Glue goes down between plies like ribbons of toothpaste.



E

After checking for voids on cross plies, a worker lays the back ply.



F

The two-story press bakes and squeezes the laid-up plies.

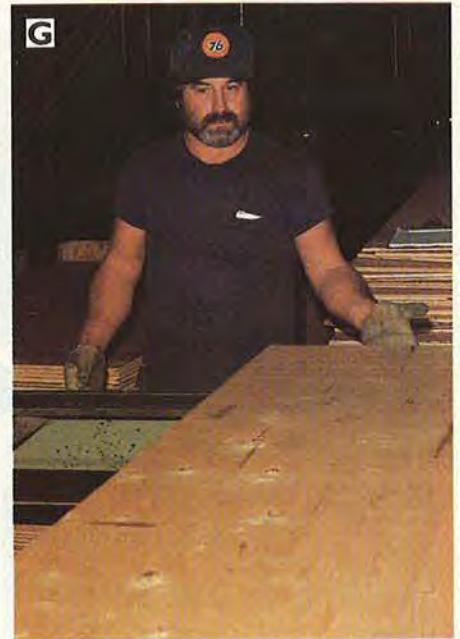

G

Inspectors check to see if sheets meet grading specifications.

HOW TO READ A SOFTWOOD PLYWOOD GRADE STAMP



PANEL GRADE — **A-B** — GROUP 1 — SPECIES GROUP NUMBER

EXPOSURE DURABILITY CLASSIFICATION — **INTERIOR** — MILL NUMBER

— **000** — PRODUCT STANDARD

— **PS 1-83** —

Note: "Species group number" refers to the classification of wood by strength and stiffness. Group 1 woods rate higher than Group 5 woods.

SOFTWOOD PLYWOOD GRADING

The type of glue used to manufacture plywood panels determines their rating as exterior or interior. Next, softwood plywoods fall into one of two categories: engineered grades or appearance grades. Generally, engineered grades consist of exterior panels, made with weather-proof glue, for building construction. Appearance grades include interior panels for furniture and cabinet work.

Face and back veneers of all interior, appearance-grade softwood plywood (and some exterior grades) rate one of the following letter designations:

N = Very best, defect free; for use with clear finishes. Special order.

A = Sound, no knots or pitch pockets; football or strip patches allowed. Can stain or paint.

B = Small defects, round patches, may need filling. To be painted.

C = Numerous open defects and knots to 1" diameter.

D = Lowest grade. Knots to 2 1/2" diameter, open defects, may have interior voids. 🍄

Written by Peter J. Stephano and David Donnelly
Photographs: David Donnelly; American Plywood Association
Illustrations: Jim Stevenson

YOU'LL BE SITTING PRETTY ON THIS

Print this article

SO-SWEET



SETTEE

Whether you use it indoors as a hall bench or outdoors as a fine piece of lawn furniture, this settee will do the job admirably. The beauty and weather resistance of mahogany, plus the durability of mortise-and-tenon joinery add up to a sure pleaser.

STARTING OUT WITH THE LEGS

Note: You'll need 2 1/2 x 2 1/2" mahogany for the front and rear legs. You can either laminate thinner stock or special-order 3 x 3" turning squares and cut or plane them to 2 1/2" square. See the Buying Guide on page 73 for our source. Also, if you plan to use the settee outdoors, be sure to use epoxy for the adhesive.

1 Rip and crosscut two rear legs (A) and two front legs (B) to the sizes listed in the Bill of Materials. Chamfer both ends of the rear legs and the bottom end of the front legs. (We chamfered ours on the table saw with the blade at 45°.)

2 To form the curved section (C) of each front leg, refer to the two-step drawing at the bottom of the page and start by crosscutting a 12 3/4" length of 2 1/2" square mahogany for the curved sections. Rip the piece to a 1 1/16" thickness. Then, lay out the two curved sections (including the tenons) on the stock, using the Front-Leg Grid below as a guide.

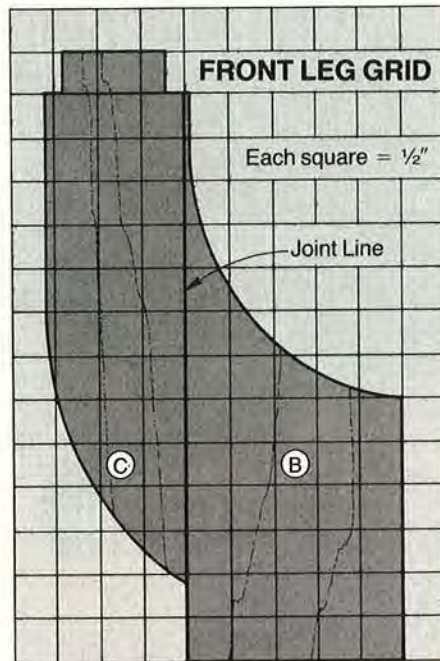

3 Mount a dado blade in your table saw, and cut a 1/2" rabbet 3/16" deep all the way around each end of the length to form the tenons as shown in step 1. Then, cut the mahogany blank in half, and cut the two curved sections to shape on the band saw. Hand-sand the curved edge of each curved section smooth.

4 As shown in step two of the drawing, clamp parts B and C together, with the shoulder of the tenon of each curved section (C) flush with the top end of each front leg member (B). Later, remove the clamps, and lay out the curved shape on the front top edge of each front leg member (B), using the Front-Leg Grid as a guide. Cut to shape and sand smooth.

FORMING THE MORTISES IN THE LEGS

1 Mark the mortise center points on the two rear legs (A) and the two front legs (B) where shown on the Rear- and Front-Leg Drawings. (Remember that you are working in pairs of A's and B's, and that the mortises in one A must be a mirror image of those in the

FORMING THE CURVED SECTION OF EACH FRONT LEG

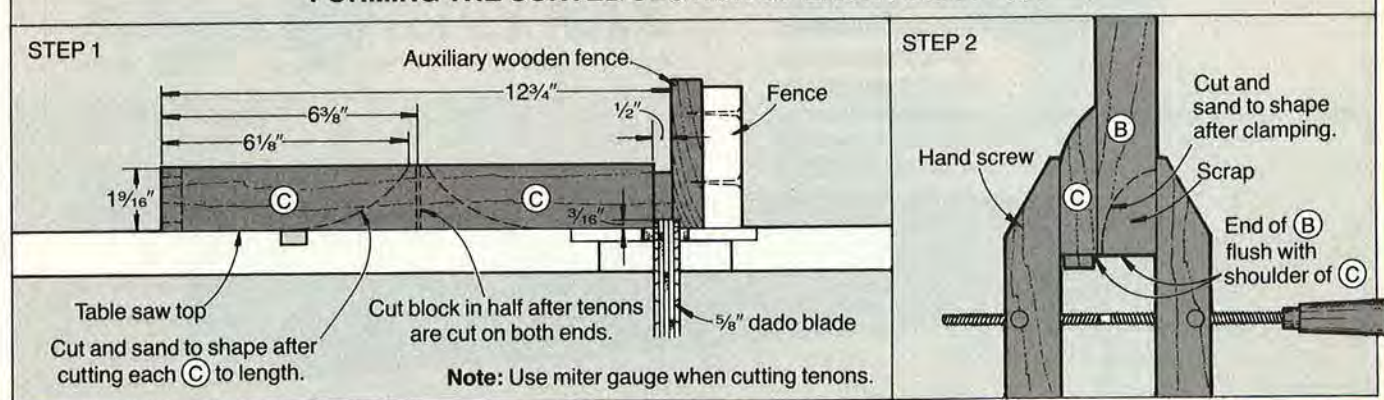

Continued

BACKREST TOP RAIL DETAIL

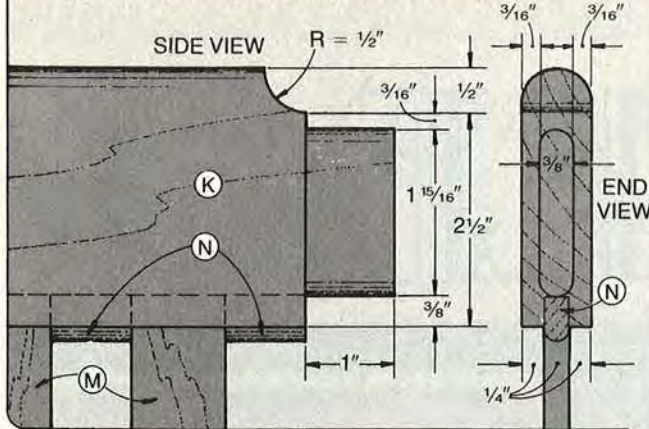

BACKREST BOTTOM RAIL DETAIL

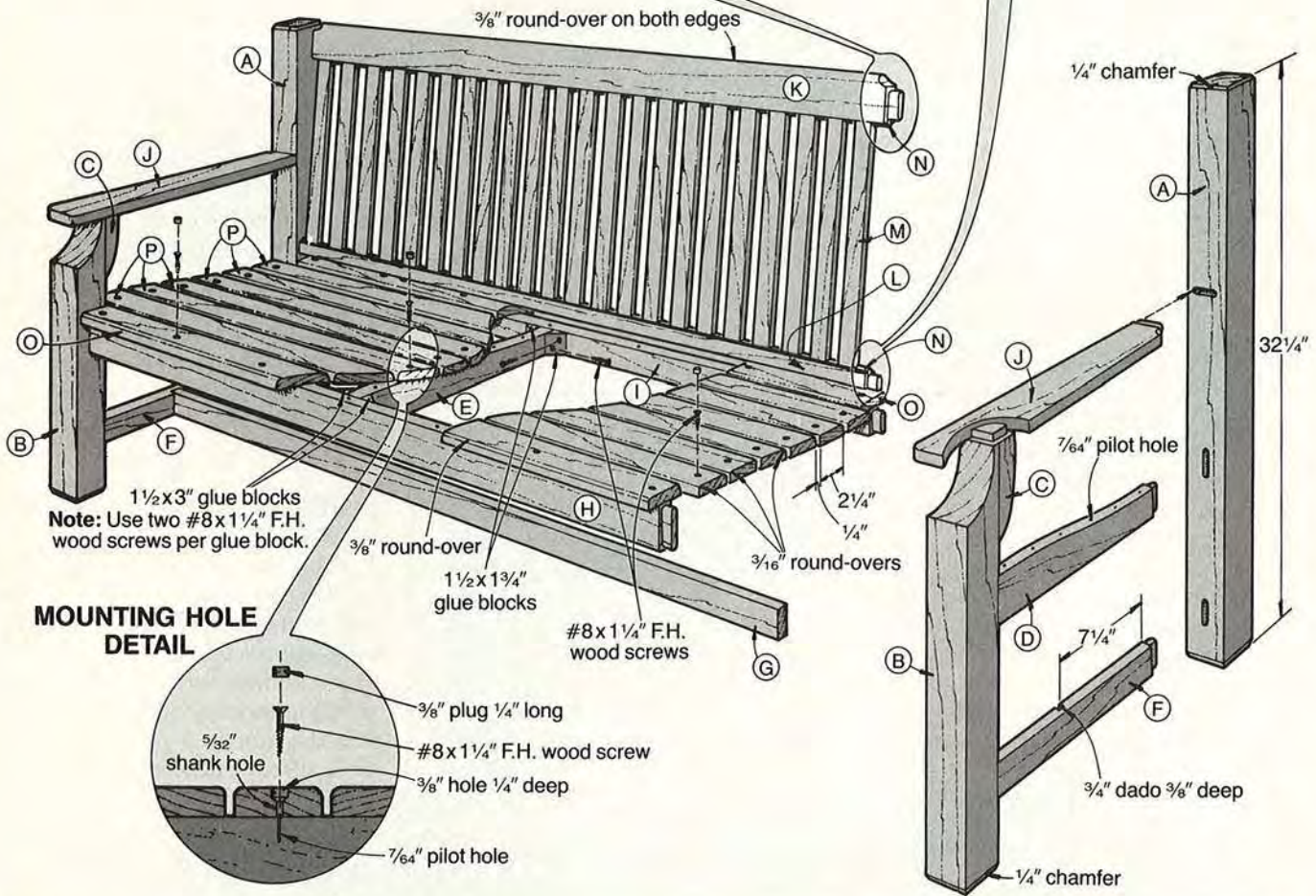
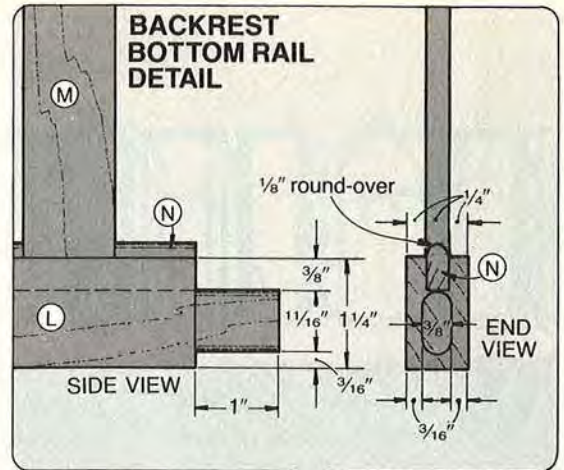

MOUNTING HOLE DETAIL

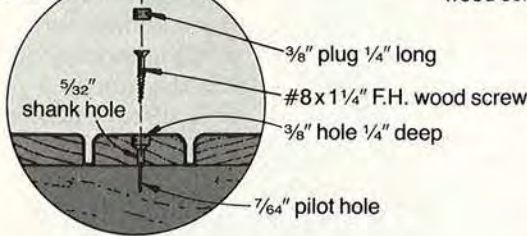

ARMREST (Bottom of right armrest shown)

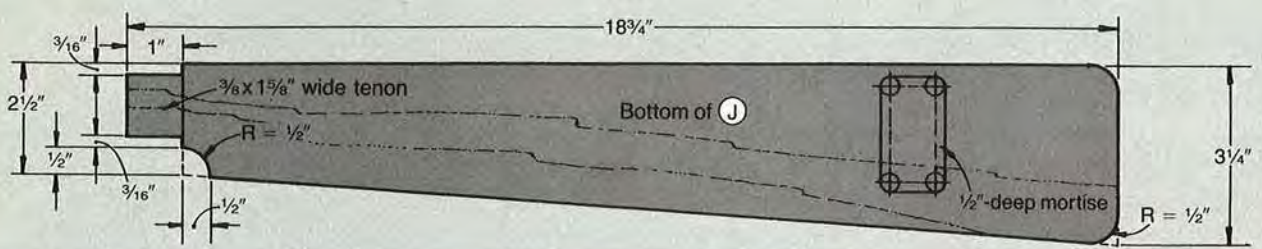

Cutting Diagram

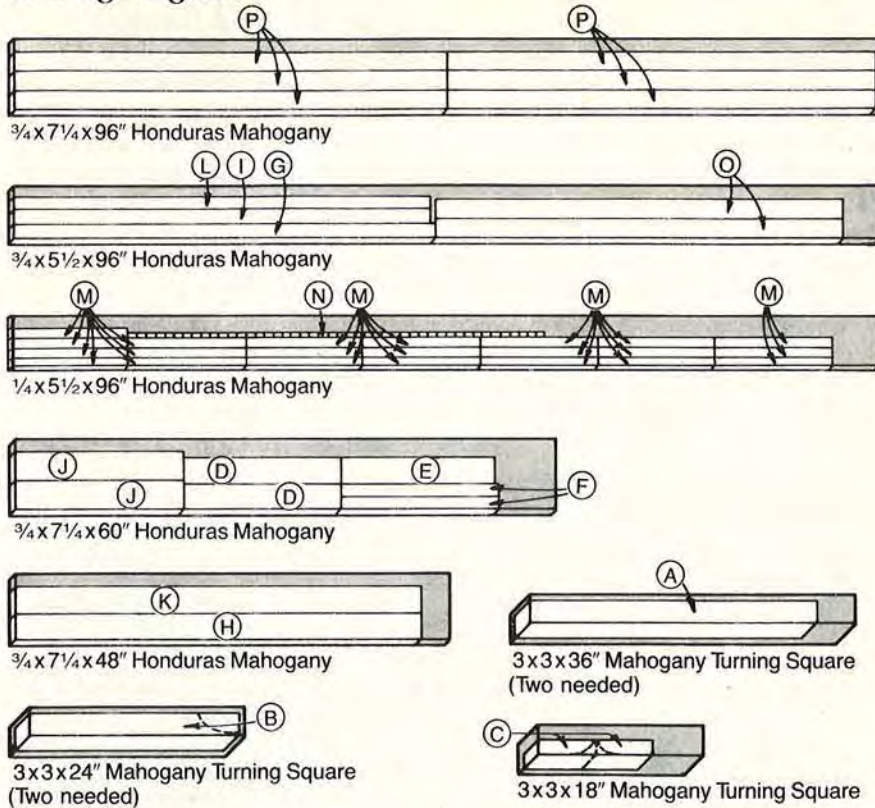

Bill of Materials

Part	Finished Size*			Material	Qty.
	T	W	L		
A	2½"	2½"	32¼"	Hond. mahog.	2
B*	2½"	2½"	23¾"	Hond. mahog.	2
C*	1⅞"	2½"	6⅞"	Hond. mahog.	2
D*	¾"	3"	17¼"	Hond. mahog.	2
E	¾"	3"	17"	Hond. mahog.	1
F	¾"	1½"	17¼"	Hond. mahog.	2
G*	¾"	1½"	46½"	Hond. mahog.	1
H	¾"	3"	46"	Hond. mahog.	1
I	¾"	1¾"	46"	Hond. mahog.	1
J	¾"	3¼"	18¾"	Hond. mahog.	2
K	¾"	3"	46"	Hond. mahog.	1
L	¾"	1¼"	46"	Hond. mahog.	1
M	¼"	1⅞"	13"	Hond. mahog.	22
N*	¼"	½"	15⅞"	Hond. mahog.	46
O	¾"	2¼"	44"	Hond. mahog.	2
P	¾"	2¼"	48½"	Hond. mahog.	6

*Parts marked with an * are cut larger initially, and then trimmed to finished size. Please read the instructions before cutting.

Supplies: #8x1¼" F.H. wood screws, white glue, woodworker's glue or epoxy, clear polyurethane or white urethane

REAR LEG (Left rear leg shown)

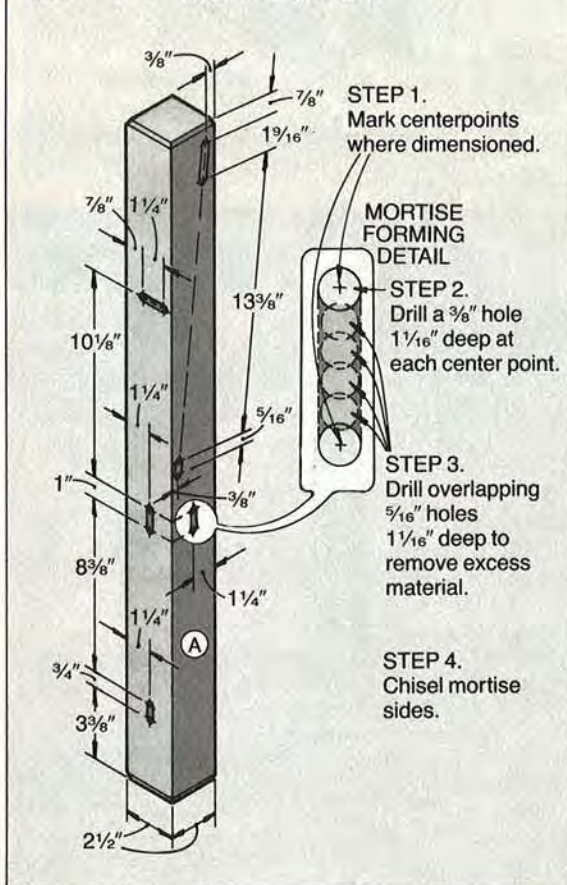

SIDE AND CENTER RAIL GRID

Each square = 1"

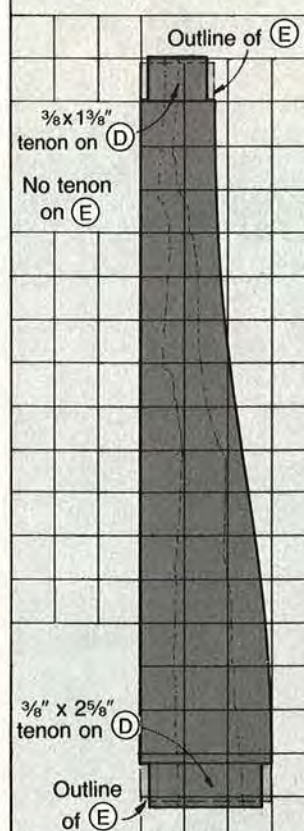

FRONT LEG (Right front leg shown)

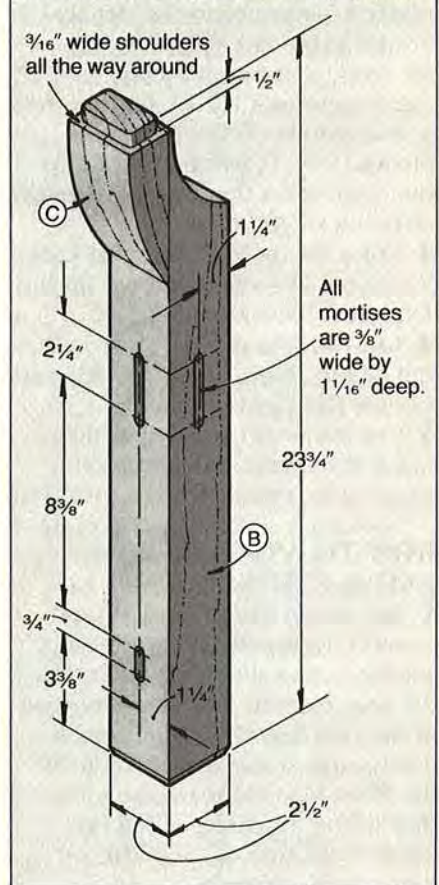

Continued

other.) Mark all the mortise center points on each pair before drilling to ensure that you mortise the correct edges of each leg.

2 Form the mortises, following the multi-step sequence outlined in the Mortise-Forming Detail on the previous page.

CUTTING AND TENONING THE OTHER FRAME MEMBERS

1 Cut the side rails (D), center rail (E), and lower rails (F) to the sizes listed in the Bill of Materials. Cut the stretcher (G) to size plus 1" in length. Cut the seat rails (H, I), armrests (J), backrest top (K), and the backrest bottom (L) to size. (Do not make the contour cuts on D, E, and J yet; you'll cut them to shape after tenoning.)

2 Cut tenons on both ends of the side rails (D), lower rails (F), seat rails (H, I), the back end of the armrests (J), and both ends of the backrest top and bottom (K, L). Refer to the Side and Center Rail Grid for the tenon sizes on the side rails (D). See the Armrest Drawing for the tenon size on the armrest, and refer to the details on the Exploded-View Drawing for tenon sizes on the backrest top and bottom (K, L). Cut the rest of the tenons on the remaining pieces (E, H, I) using the shoulder dimensions on the Tenon Forming Drawing *at right*.

3 Cut a $\frac{3}{4}$ " dado $\frac{3}{8}$ " deep in each lower rail (F) where shown on the Exploded-View Drawing.

4 Cut the side rails (D) and center rail (E) to shape using the Side and Center Rail Grid as a guide.

5 Cut the armrests to final shape using the Armrest Drawing on page 70 as a guide.

HOW TO ASSEMBLE THE END SECTIONS

1 Dry-clamp the legs (A, B) and rails (D, F) together. Square each assembly, and slide the tenon on the armrest into its mating mortise in the rear leg. Hold the armrest firmly against the tenoned top of the front leg, and mark the location of the mortise needed on the bottom side of each armrest. Remove the armrest.

2 To form the mortise on the *bottom* side of each armrest, use a flat-bottomed bit, and drill a $\frac{1}{2}$ "-deep hole at each corner of your layout lines. Now, drill overlapping holes to remove stock and finally, chisel the mortise clean.

3 Check the fit of the end sections again with the armrests in position. Now, glue and clamp the end sections together, checking both for square. Position, but **DO NOT** glue the armrests to their mating parts at this point. You'll do this later, after the seat slats have been attached.

NOW, COMPLETE THE FRAME AND BUILD THE BACKREST

1 Dry-clamp the seat rails (H, I) and backrest top and bottom (K, L) between the end assemblies and check for square. Measure the distance between the dadoes in the lower rails (F), and cut the stretcher (G) to fit. Remove the clamps and disassemble.

2 Using the Backrest Top Rail Detail on the Exploded-View Drawing as a guide, cut or rout a $\frac{1}{4}$ " groove $\frac{3}{8}$ " deep centered along the bottom edge of the backrest top rail (K) and along

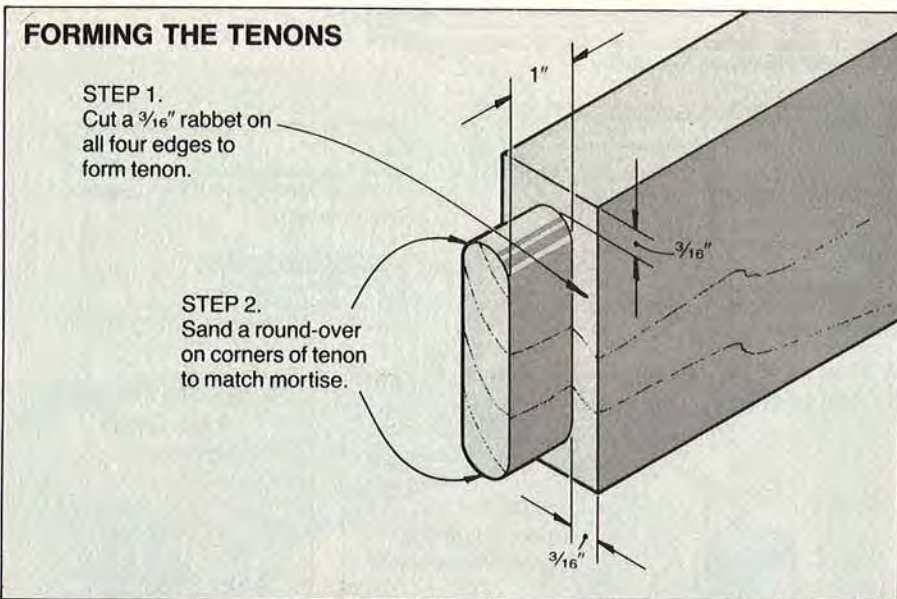

the top edge of the bottom rail (L). (We cut ours on the table saw fitted with a $\frac{1}{4}$ " dado blade. We also used a feather board to keep the pieces firmly against the fence when dadoing.)

3 Rip 11 strips $1\frac{1}{64}$ " wide by 13" long from $\frac{3}{4}$ " mahogany stock. Now, resaw each strip to obtain two $\frac{1}{4} \times 1\frac{1}{64}$ " wide strips for the splats (M). (We inserted the backrest top and bottom rails into their mating mortises and measured the length needed for the splats.) To form the spacers (N), start by cutting two strips $\frac{1}{4} \times \frac{1}{2} \times 30$ " long. Rout or sand a $\frac{1}{8}$ " round-over along one edge of each long strip. Now, set a stop and cut the spacers (plus a few extra) to length ($1\frac{5}{16}$ ").

4 Measure and mark the lengthwise-center of the backrest top rail (K) and the center of one spacer (N). As shown in photo A, position the marked spacer in the groove, and align its center mark with the centerline on the backrest top rail. Working from the center out, glue and clamp the splats and spacers in position, checking *each* splat for square. If the spacers on each end extend past the groove, trim them to length.

5 Once you have glued all the spacers and splats in position in

the backrest top rail, clamp a scrap strip on each side of the splats to align them as shown in photo B. Now, run a bead of glue down the groove in the backrest bottom rail, and tap this part onto the ends of the splats as shown in the photo. As soon as all the splats are positioned in the groove in the bottom rail, flip the assembly over to keep the glue in the groove from running down the splats. Wipe off any excess glue with a wet rag immediately.

6 Again, starting at the center, glue the spacers in position, trimming the end spacers if they protrude. Check the fit of the backrest assembly (K, L, M, N) into the mortises in the rear legs. Separate the backrest assembly from the rear legs.

7 Rout a $\frac{3}{8}$ " round-over along the top edges of the backrest top rail (K). Then, mark and cut a $\frac{1}{2}$ " radius on each top corner of the backrest top rail. Sand each radius smooth with a $\frac{1}{2}$ " drum sander.

BUILDING THE SEAT

1 Glue and clamp the seat rails (H, I) and the backrest assembly between the end sections, checking for square.

2 Clamp the center rail (E) between the seat rails, centered

from end to end. Cut four triangular-shaped glue blocks to the size stated on the Exploded-View Drawing. One at a time, hold a glue block in position against the center rail, and drill $\frac{7}{64}$ " pilot holes and $\frac{5}{32}$ " shank holes. Finally, glue and screw the glue blocks to the framework to hold the center rail in position.

3 Cut the seat slats (O, P) to size. Rout a $\frac{3}{16}$ " round-over along the top edges of each. Cut several strips of scrap wood $\frac{1}{4}$ " wide for use as spacers. Clamp the front slat (O) to the bench flush with the front edge of the front legs (B). Now, work toward the back, spacing the slats $\frac{1}{4}$ " apart with the scrap spacers.

4 Once all the slats are clamped in position, drill plug, shank, and pilot holes to the sizes indicated in the Mounting-Hole Detail on the Exploded-View Drawing.

5 Again, starting with the front slat, remove the clamps, and glue and screw the front slat to the bench framework. Proceed toward the back, one slat at a time.

6 Plane a piece of mahogany to a $\frac{5}{16}$ " thickness and cut thirty two $\frac{3}{8}$ "-diameter plugs from it. Plug the screw holes and sand the plugs flush.

7 Glue and clamp the armrests (J) in position.

FINISHING UP

1 Sand the settee smooth. Stain and finish as desired. (For indoor use, we finished the settee with clear polyurethane and no stain. For outdoor use, we applied two coats of white exterior urethane.)

BUYING GUIDE

● **Mahogany turning squares.** $3 \times 3 \times 24$ ", unsurfaced, catalog no. W2355, \$9.35 each (two needed). $3 \times 3 \times 36$ ", unsurfaced, catalog no. W2375, \$15.46 each (two needed). $3 \times 3 \times 18$ ", unsurfaced, catalog no. W2345, \$7.07 (one needed). Craftsman Wood Service, 1735 W. Cortland Ct., Addison, IL 60101, or call 312/629-3100. ●

Project Design: James R. Downing
Photographs: Bob Calmer
Illustrations: Kim Downing; Bill Zaun



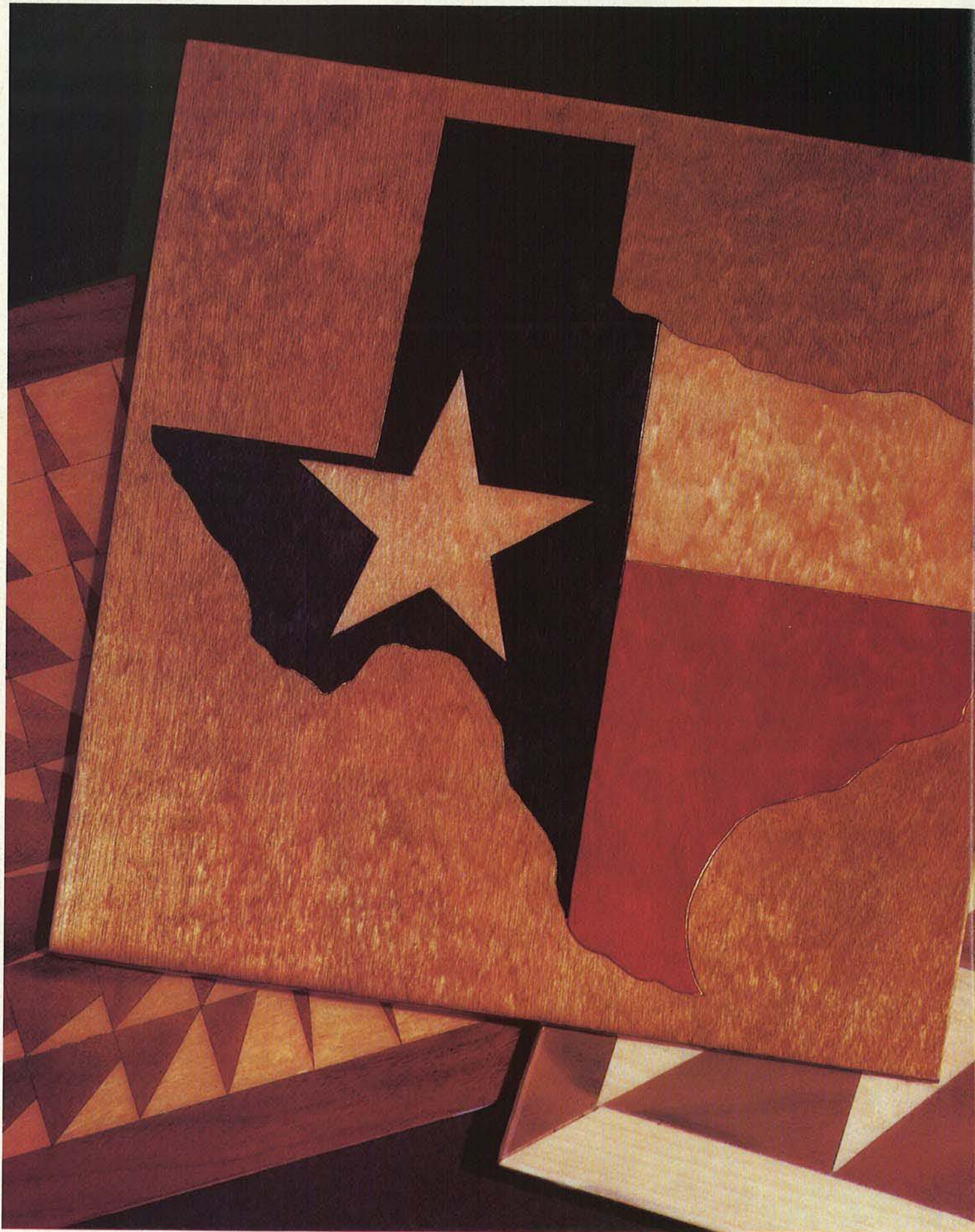

MAKING
HIS
MARK IN

Marquetry

 Print this article

John Wilson brings a contemporary style and technique to this centuries-old art. When you find out how he does it, you'll want to give it a try, too!

Way back in high school John Wilson's art teacher predicted that he would become a designer. Admittedly a class cutup at the time, John wasn't quite sure what that meant. Yet, he eventually graduated from a top design school.

Now John makes a living seeing things others don't. He looks for another way to build or do something, and never accepts what is for what could be. His list of patents attests to that high school teacher's accurate insight. He has designed such diverse commercial products as an open face spinning reel, a personal computer cabinet, and ultra-sound equipment for use in sports medicine.

Just for the heck of it, John designs and redesigns some pretty commonplace items, too. You'll find the evidence around his workshop: a miterless picture frame, an all-wood veneer roller that won't scratch, and a taller-than-average shoe shine box for portly people who can't stoop. You see, even at leisure, John never quits design-

ing. "Some problem will catch his attention and he'll chew on it and chew on it," says his wife, "until he gets it out of his system."

Usually John gets it "out of his system" by sketching an idea on his drawing board. If the idea shows promise, he'll take it to the workshop. "Normally," John explains, "I'll spend two-thirds of the time designing, and one-third building a project. Most of what I make has some rhyme or reason. If there's no problem, it's not interesting to do." And that, exactly, was how John got into marquetry.

Bringing marquetry into the 20th century

"Why can't letters and numbers be drawn solid? Why, for instance, does an 'O' have to look like a doughnut?" Believe it or not, that's what was going through John's head a few years back when he decided to work out this problem in wood veneers. The piece of marquetry displaying his solution (next page), proves that solid numbers and letters can indeed be leg-

John Wilson, 56, shown at his drawing board, *left*, gets paid to be creative. As an industrial designer, he designs products for companies. John not only makes things look better, he often designs them so they're simpler to make. That's what he does with his marquetry, but just for fun, as with his salute to the Lone Star state and the "20th-century" designs shown *opposite*.

After visiting with John and Jan, his wife, in their Tulsa, Oklahoma home, we realized John's creativity has few bounds. Their living room boasts his paintings. His wood-working shop has drawings for everything from puzzles to slingshots. To John, his workshop represents recreation — a place to work his mind not take his mind off his work!



Continued

Marquetry

ible. And, he discovered, they're also much easier to cut out!

The way it works with John, one thing leads to another, and he began designing other marquetry projects. He saw no reason why marquetry had to be done in what he calls "traditional" designs.

"I don't like the pretty fields and streams and other scenics of most marquetry," he says, "so I started drawing bold, geometric designs. For me, this was bringing marquetry into the 20th century. I even thought about selling the designs, because they're easy to do."

By using techniques nearly as untraditional as his designs, John eliminated tools such as fret and veneer saws, edge trimmers, clamps, and veneer hammers. He's also done away with any edge-beveling of individual pieces, and relies primarily on a metal combination square, a metal ruler, an X-acto knife with No. 11 blades, and a pencil. For

his brand of marquetry, these tools match the material perfectly.

"I prefer the new flexible veneers over the thicker, more rigid types," John notes. "Flexible veneers are about $\frac{1}{64}$ " thick, and

have a thin paper backing. They're more expensive than heavier, $\frac{1}{28}$ - or $\frac{1}{40}$ "-thick veneers, but they won't chip as easily, either. And, these thin veneers cut clean with little effort using an X-acto."



To prove that letters and numbers could be made solid, John designed this marquetry pattern. "They're easier to cut out that way, too," he claims.

EASY AS ONE, TWO, THREE...

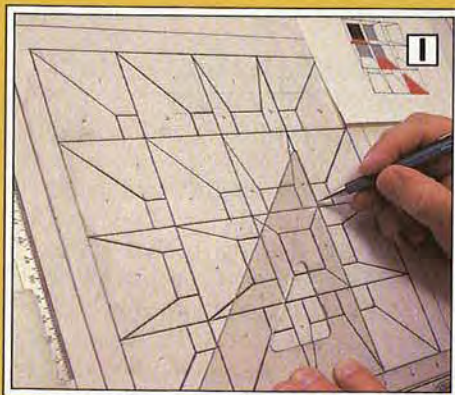

1. After hours of working on a tiny thumbnail sketch, John redraws the final design, full-size, on acetate.

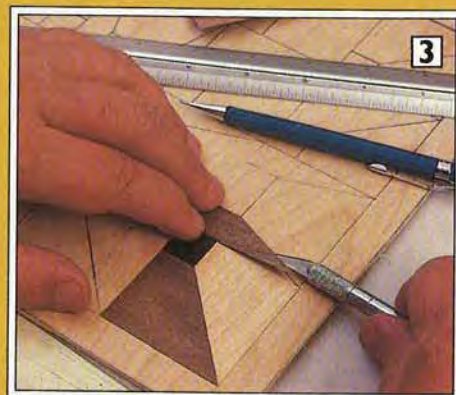

2. Masking tape laid down on the pattern helps John follow the lines in cutting the corner, and starter piece of veneer.

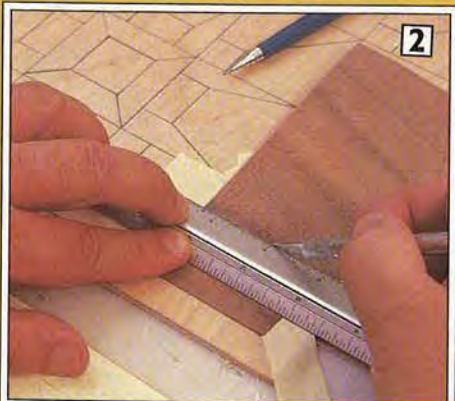

3. After he cuts and fits a piece, John glues it down with rubber cement. The left edge of the pieces create a straight line to square other pieces against.

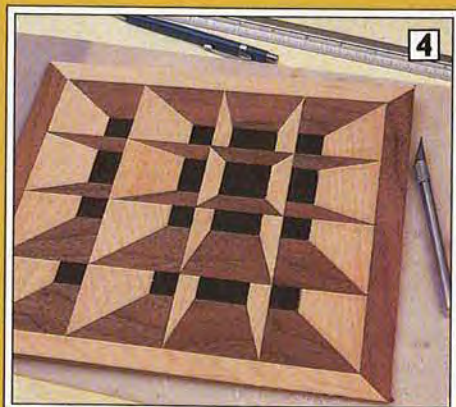

4. Completed, the marquetry will be pressed, then finished with polyurethane. Many of John's patterns are drawn in perspective to make them look three-dimensional.

From tiny sketches full-size patterns grow

Sometimes, John draws 10 or more tiny sketches, called "thumbnails", before a design evolves to the point where he wants to try it in wood. Then, he makes a full-scale drawing of the marquetry pattern, as shown in photo 1.

Next, he'll transfer his pattern directly to the wood on which he'll lay the veneers. "You can buy regular backing board from veneer suppliers, but it's a dark brown color and the layout lines don't show up well enough. So, I use a plain old $10 \times 10 \times \frac{1}{8}$ " piece of sanded AB plywood," John says.

The trim and fit of marquetry

Unlike most aspects of woodworking, marquetry requires little space and creates little mess. You can do it practically anywhere. John often works at the desk in his home.

To make the geometric pattern shown *below*, he uses one square foot each of walnut and maple flexible veneer. The maple serves as the light-colored wood *and* as the black — he stains it with water-colors to obtain black.

John glues down the cut veneers with rubber cement. "That way I can work the pieces over and over until they fit perfectly," he advises. "When it's finished, a heavy coat of polyurethane over the top keeps them from coming unglued." But if he were going to use the marquetry for a tabletop inlay rather than a plaque, John would use contact cement.

John always begins his geometric patterns by cutting and gluing down a corner piece, as he's doing in photo 2. That way, his second piece will have a veneer edge to square up against. The masking tape laid along the pattern lines helps guide his rule and knife.

"Be sure to cut all the pieces of each type of veneer so that when you lay them down, the grain all runs in the same direction," warns John. "Otherwise, alternating grain really distracts the eye. And, when you make a cut," he continues, "always pull the knife toward you because it's easier to control. Turn your workpiece around if you have to rather than cut away from yourself."

Continuing on the pattern, John lays down pieces along one of his vertical pencil lines in order to keep them straight. In photo 3, he's laying down a piece of walnut against one of "black" maple.

To complete the plaque, photo 4, he adds a border of contrasting veneers on the face. John warns that the completed piece may warp a bit by the time the last piece goes down. To flatten it while the glue dries, he presses the board overnight between the desktop and a piece of $\frac{3}{4}$ " plywood with a weight on top.

For a finish, John "floods on" polyurethane varnish rather than brushing it. To do this, he first heats the varnish on a hot plate. "This changes the urethane's viscosity so the little air bubbles escape," he says. John pours the warm finish directly onto the middle of his plaque, and it spreads evenly over the marquetry.

Because the plywood backing board is so thin, John says, he rarely attempts to band or conceal it. Although his work could be framed, John prefers to have it stand alone. Any boxing might detract from its illusionary three dimensions. And to John's designing eye, 20th-century work should be able to stand alone.

Why not try your hand at marquetry? Just follow the same step-by-step process John does, and use the same materials for the eye-catching piece shown in the pattern at left. ♣

Written by Emily Freeman Pinkston
Photographs: Bob Hawks
Drawing by Bill Zaun
Designs: John T. Wilson

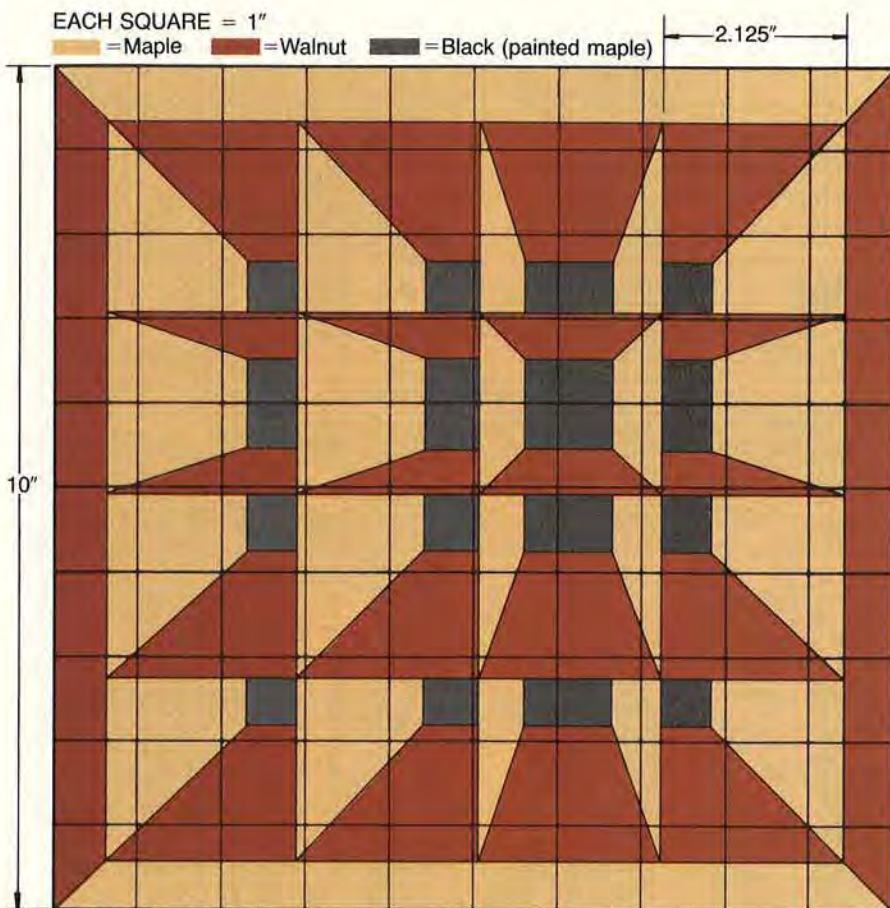

CARVE FRENCH LOUIE

AN ADIRONDACK MOUNTAIN HERMIT
BY RICK BUTZ



One in a collection
of regional patterns
from the nation's
top carvers



Rick Butz

Rick and Ellen Butz live on a mountainside near Blue Mountain Lake, New York. In their Adirondack mountain setting, they make their living carving birds, animals, and figures of

the area. Rick, shown above at his workbench, has also authored books on woodcarving and teaches it in a PBS television series "Woodcarving with Rick Butz."

Rick finds the source for many of his figures in old photographs. One of his favorite characters to carve happens to be the legendary hermit, French Louie.

According to Rick, French Louie lived in the 1800s. Although his home was a solitary one deep in the forest, French Louie occasionally guided hunting parties to earn a few dollars for supplies. When he got paid, French Louie went on notorious sprees, buying drinks for the whole town. Then, he'd shoulder his sacks of flour and disappear into the woods.

Rick's characterization of French Louie, complete with Adirondack pack basket and ax, stands about 6" tall. The transparent colors suggest the hermit's rough, faded clothes.

Tips on carving French Louie

Rick likes to carve air-dried, eastern white pine. But you can use your favorite carving wood for French Louie, as long as it holds detail and takes paint.

About the only tricky part of this carving you'll find will be the hat brim. Says Rick: "You'll be working with a thin — about 1/8" thick — section of cross-grain wood, and too much pressure will break it. To avoid the problem, Rick advises you "shape the hat's crown and upper brim first. Then, use a coping saw to cut around underneath the brim to a 1/16" depth. After that, it's fairly easy to carve away the excess around the head and leave the hat brim intact."

If you want to finish your carving the way Rick does, thin artist's oil colors with turpentine to the consistency of stain. "This gives your carving a soft, transparent color that still allows the grain to show through," Rick notes. "After the paint dries, apply a thin coat of paste wax, then buff it for a mellow, burnished finish."

Note: For a full-size pattern of French Louie, send a self-addressed, stamped envelope to: CARVING PATTERN, WOOD Magazine, Locust at 17th St., Des Moines, IA 50336. 🌲

Design and photograph: Rick Butz

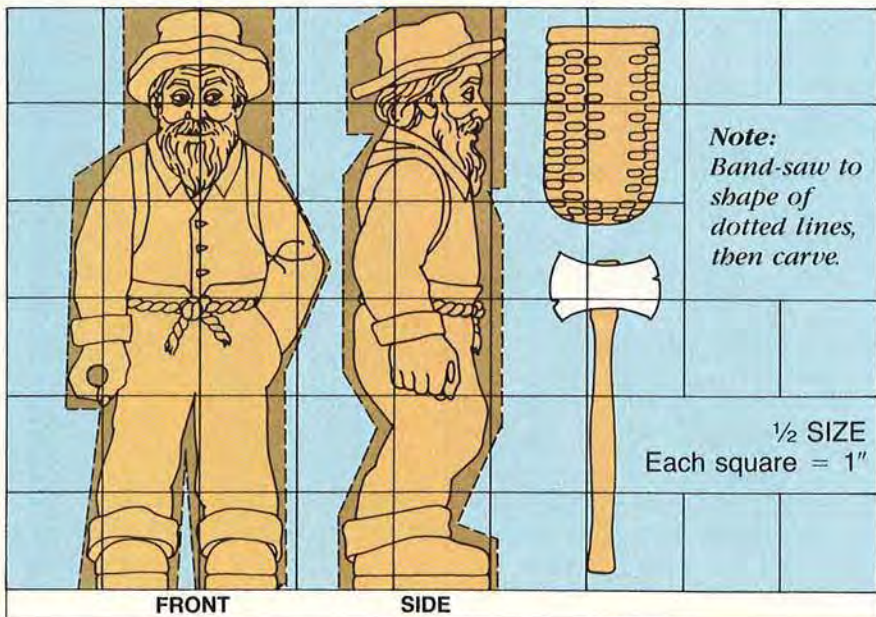

FRONT

SIDE



DELTA MACHINERY

		LIST	SALE
23-700	Universal Wet/Dry Grinder	169.00	134.95
40-500	15" Hobby Scroll Saw	105.00	84.00
28-160	10" Bench Band Saw	167.00	139.00
23-680	6" Bench Grinder	65.00	59.00
23-880	8" Bench Grinder	105.00	93.95
28-560	16" Motorized Band Saw	495.00	389.00
11-950	8" Drill Press	133.00	118.00
34-080F	10" Miter Box, Electronic Brake	279.00	224.95
34-897F	Unifence, 50" Capacity	425.70	325.00
43-122	Lt. Dty. Wood Shaper, w/Motor & Stand	748.00	499.00
28-243S	14" Band Saw w/Motor, Stand & 25-858 Lamp	781.50	499.00

**"Free" Freight on Machinery
Shipped in Continental U.S.A.**

All Prices Subject to Change Without Notice

PERFORMANCE GUARANTEED



40% OFF
ALL DELTA CARBIDE TIPPED
CIRCULAR SAW BLADES

FOR 1/2" - 3/4" - 1 1/4" SPINDLES



40% OFF
ALL DELTA CARBIDE TIPPED
SHAPER CUTTERS

**FREE FREIGHT ON SAW BLADES AND SHAPER CUTTERS
IN CONTINENTAL U.S.A.**



ARONSON INDUSTRIAL SUPPLY

5300 DENVER AVE. SO. P.O. BOX 80987 • SEATTLE, WA 98108

Serving
Woodworkers
Since 1916

SEATTLE
☎ 206-762-0700

WASHINGTON WATS
☎ 1-800-562-8375

OUT OF STATE WATS
☎ 1-800-824-4256

CARBIDE TIPPED ROUTER BITS PROFESSIONAL PRODUCTION QUALITY

1000's SOLD TO READERS OF FINE WOODWORKING

BEST CUT BEST PRICE	ITEM NO.	DESCRIPTION	RADIUS	LARGE DIAM.	CUTTING LENGTH	PRICE
	COVE					
	#01	1/4" R	1/4"	1"	1/2"	\$13.00
	#02	3/8" R	3/8"	1 1/4"	9/16"	14.00
	ROUND OVER					
	#04	1/4" R	1/4"	1"	1/2"	15.00
	#05	3/8" R	3/8"	1 1/4"	5/8"	16.00
	ROMAN OGEE					
	#07	5/32" R	5/32"	1 1/4"	15/32"	18.00
	#08	1/4" R	1/4"	1 1/2"	3/4"	20.00
	RABBETING		Deep			
	#11	3/8"	3/8"	1 1/4"	1/2"	14.00
	#09	1/8" (KERF) SLOT CUTTER	1/4"	1 1/4"	1/8"	14.00
	#10	1/4" (KERF) SLOT CUTTER	1/4"	1 1/4"	1/4"	14.00
	#12	45° CHAMFER	45° Angle	1 1/2"	5/8"	15.00
	RAISED PANEL		20° Angle			
	#15			1-5/8"	1/2"	25.00
	#35	1/4" V Groove 90°		1/4"	1/4"	8.00
	#36	3/8" V Groove 90°		3/8"	3/8"	9.00
	#37	1/2" V Groove 90°		1/2"	1/2"	11.00
	#16	3/8" Dovetail 9°		3/8"	3/8"	7.50
	#17	1/2" Dovetail 14°		1/2"	1/2"	8.50
	#18	3/4" Dovetail 14°		3/4"	7/8"	10.50
	CORE BOX (ROUND NOSE)					
	#19	3/8" Core Box	3/16"	3/8"	3/8"	11.00
	#20	1/2" Core Box	1/4"	1/2"	11/32"	14.00
	#21	3/4" Core Box	3/8"	3/4"	5/8"	18.00
	GROOVE FORMING OGEE					
	#22	1/2" Grooving Ogee		1/2"	3/8"	16.50
	#23	3/4" Grooving Ogee		3/4"	7/16"	21.00
	#24	1/4" Straight Bit		1/4"	3/4"	7.00
	#25	5/16" Straight Bit		5/16"	1"	7.00
	#26	3/8" Straight Bit		3/8"	1"	7.00
	#27	1/2" Straight Bit		1/2"	1"	7.00
	#28	3/4" Straight Bit		3/4"	1"	10.50
		Flush Trim				
#13		1/2" FLUSH TRIM		1/2"	1"	8.50
	Key Hole					
	#14	3/8" KEY HOLE (This Bit only HSS)			CUTS 3/8" KEY HOLE FOR FLUSH MOUNTING PICTURE FRAMES, ETC.	8.50

**WHEN ORDERING ANY THREE OR MORE DEDUCT \$1.00 EACH
ALL PRICES POSTAGE PAID**

- Professional Production Quality • 1/2" Ball Bearing Pilot
- 1/4" Diameter Shanks × 1 1/4" Long • One Piece Construction
- Two Flute Thick High Quality Tungsten Carbide Tips

To order by MasterCard or Visa Toll Free
7 Day—24 Hour Order Service Call
1-800-533-9298 (In PA 1-800-346-7511)
or send check to:

MLCS, P.O. Box 53D, Rydal, PA 19046

Sander Specials

**Speed-Bloc®
Finishing
Sander**
Palm grip design with
Stikit® Pad #330
LIST \$87.50
SALE
\$54.00

**Paint
Remover**
Removes paint
quickly from wood,
compositions, and
many other surfaces.
#303 LIST \$220.50
SALE
\$155.00

**Heavy Duty
Finishing
Sander**
9 3/8" x 4 1/2", with
Stik-it pad and orbital
action, direct-drive
motor #505
LIST \$175.00
SALE
\$113.00

**Send \$2.00
for our new
Woodworking
Tool Catalog**
(Refundable with first order)

W.S. JENKS & Son



TOLL-FREE
800-638-6405

1933 Montana Ave. NE Washington DC 20002
202-529-6020 TELEX: 89-2667 FAX: 202-832-3411

KILN DRY YOUR OWN LUMBER

nyle corporation

the nation's largest manufacturer of dehumidification dry kilns is now offering small 500 to 10,000 board feet drying systems.

- ★ Made completely in the USA
- ★ The leader of the industry
- ★ Offering excellent warranties
- ★ Expert consultation and service

nyle DRY KILN SYSTEMS

Box 1107-A, Bangor, Maine 04401
Telephone 1-800-648-9200
or 207-989-4335

BEST VALUES

IN WOODWORKING MACHINERY

15" THICKNESS PLANER

complete with floor stand

Big planing capacity at a reasonable price from the woodworking specialists. Saves time and money, Pays for itself in no time.



14" WOOD LATHE

with duplicator and stand



Produce identical copies or singles. For the pro or beginner. Multi speed. Priced for everyone.

EASY TERMS! FREE 45 DAY TRIAL IN YOUR SHOP

Send for complete information! Don't Delay!

GREAT PLAINS MACHINERY CO.

Dept. 1443, 4050 Broadway, K.C., Mo. 64111

- YES! Please rush me my FREE PLANER INFORMATION KIT.
- YES! Please rush me my FREE LATHE INFORMATION KIT.

NAME _____

ADDRESS _____

CITY/STATE _____ ZIP _____

WOODWORKERS! Sand like professionals, quickly and beautifully



◆ #B-12 Brush Head sands mouldings and intricate carvings without losing detail or shape of the part.



Model #DD-63

Gives quick and excellent results on contoured-shaped parts.

Everything we sell is industrial quality. Buy the complete unit or just the Brush Head and/or Pneumatic Drum and build your own.

Professional results in no time at all. Write or call for the dealer nearest you.

Sand-Rite 321 North Justine St.
Chicago, IL 60607
MANUFACTURING CO. 312-997-2200

SHAKER PEGS CANDLE CUPS MUG PEGS

\$17.95 per 100, prepaid.
Wide selection of other wood products.

Catalog \$2.00 or free with order.

Benny's Woodworks

P.O. Box 656, Dept. WD5
Antioch, TN 37013
(615) 331-8384

Shaker Peg



Mug Peg



HORTON BRASSES

Nooks Hill Road, P.O. Box 120J
Cromwell, CT 06416 (203) 635-4400

HORTON BRASSES are authentic copies of 17th, 18th, 19th & early 20th century pulls



Mfrs. of Cabinet & Furniture Hardware for Homes & Antiques.
Send \$2.00 for a Catalogue.

Van Dyke's

Presents a Catalog

with supplies for upholstery, antique restoration, wood working, caning, brass hardware, carvings and many related trades!

36 Years in Creative Arts & Trades

Many Hard-To-Find Items!

SEND \$1.00 FOR CATALOG TO:
Van Dyke's Restorers
Dept. D55 - Woonsocket, SD 57385



Wood Moisture Meter

- Avoid Moisture Problems
- Protect your Masterpiece

Mini-Ligno \$110 only

Pocket-Size: 1"x2 1/4"x5 1/2"
Incl. Case, Batteries, and Pins for 1/8" and 7/16" Measuring Depth.

also from Lignomat:

Mini-Ligno E

Range: 6, 7, ...36%

Easy to use, sturdy instrument for the professional woodworker or serious hobbyist. Great for lumber, veneer, fiberbrds. Ask for free catalog on all moisture meters and accessories for kiln drying. Don't waste money, time on wet wood, order a moisture meter now.

Lignomat USA Ltd.

503-257-8957 800-227-2105

P.O. Box 30145 bh
Portland, OR 97230



LOW PRICES • HIGH QUALITY

Toll Free Phones! • 1-800-624-3938

In Ill. 1-800-358-4208

Love - Built Toys

The Toymaker Supply Co.

105 Weiler Rd. T34
Arlington Hts., IL 60005

For Volume Purchases of Quality Toy Parts..Write or Phone Today For Free Catalog!



—Rare—

MACASSAR EBONY

MAGNIFICENT GRAIN,
high figure or subtle.

MATCHLESS DIMENSIONS,
1" up to 9" thick, 4" up to 20" wide.
Random lengths to 9 feet. Best selection available in the U.S.

LOWEST COST from a DIRECT IMPORTER. NO MINIMUM ORDER.

A. Eisenbrand, Inc.

4100 Spencer Street, Suite EW8
Torrance, CA 90503
(213) 542-3576

BAND SAW OWNERS!

A NEW TOOL is now available so you can make or repair any length Band Saw Blade in minutes!

This patented tool was developed for use in our own shop and has proven itself with thousands of high quality, true running splices.

Our splicer enables any craftsman to make up any length blade from economical coil blade stock QUICKLY and EASILY. The resulting silver brazed joint normally outlasts the service life of the blade.

Three models are currently available:

1C-001 1/4" to 3/4" Blades.....\$ 49.95 ppd
1C-002 1/2" to 1 1/2" Blades..... 49.95 ppd
1C-003 3/8" to 1 1/2" Blades..... 150.00 ppd

The tool comes complete with detailed instructions and supplies for approximately 100 splices.

We also carry additional supplies and OLSON band saw stock at reasonable prices.

Send L.S.A.S.E. for FREE information to:

NEW MILFORD SPECIALTIES CO.

Dept. BH, 24A South Main Street

New Milford, CT 06776

(203) 426-4276

PIN ROUTING ATTACHMENT

Continued from page 39

hinge holes in the top support slightly off-center toward the back to ensure a snug fit.) Trim the wing ends flush with the ends of the top support.

2 Position the hold-down on the top support, align it with the arm, and clamp it into place. Drill mounting holes and hinge the hold-down to the top support firmly against the back edge of the arm.

3 Place the alignment pin into the $\frac{3}{4}$ " hole in the arm. Epoxy a $\frac{1}{4} \times 2$ " carriage bolt in the $\frac{1}{4}$ " hole at the kerfed end of the arm, and attach a flat washer and wing nut to the bolt to hold it secure until the epoxy dries. Finish the pin router as desired. (We disassembled the parts, masked off the hinges, and applied polyurethane to the supports, wing assembly, and pins.)

4 Raise your table-mounted router so the collet protrudes slightly above the surface of the table. Position the pin-routing attachment (with a couple of spacers beneath it) so the alignment pin fits into the collet as shown in the photo below. Clamp the pin router to the router table. Using the holes in the spacers as guides, drill two $\frac{3}{8}$ " holes through the router table. Fasten the routing attachment to the router table with carriage bolts.

Note: For an in-depth look at using the pin routing attachment, see the "Template Routing" article starting on page 32. ♣



Project Design: James R. Downing
Photographs: Bob Calmer
Illustrations: Kim Downing; Bill Zaun



This VET Did It - and YOU Can Do It Too!

"War injuries left me badly handicapped, but now I'm a financial success as a Locksmith, thanks to your training. Besides, the work is fascinating. If I can do it anybody can." — Glen Johnson, Larned, Kan.

Make Up to \$26.00 an Hour — even while learning!

Train FAST at Home!

Be a LOCKSMITH!

If you enjoy fixing things, you're a "natural" to make hundreds of EXTRA DOLLARS a year in the fascinating business of Locksmithing. Rising crime has increased demand for service a thousandfold. Yet there's only one Locksmith for every 17,000 people!

COLLECT CASH PROFITS ALMOST AT ONCE!

You're "in business" ready to make \$10 to \$26.00 an hour a few days after you begin Foley-Belsaw's shortcut training. Easy illustrated lessons complete with ALL practice equipment PLUS

- ALL TOOLS YOURS TO KEEP
- KEY MACHINE YOURS TO KEEP
- EXPERT PERSONAL ASSISTANCE
- BUSINESS-BUILDING HELP

enable you to get your share of this always-profitable business. Hundreds we've trained are doing it. So can YOU.

MAIL COUPON to discover how Locksmithing can keep the extra money coming in during spare time — or in your own full-time business. Ideal for retirement—good jobs, too. **FOLEY-BELSAW INSTITUTE**, 11150 Field Bldg. Kansas City, Mo. 64111

N. Hunt, Wilmington, Del.—"I make \$50 a week extra."

R. Davis, St. Louis, Mo.—"I cleared \$110 last Saturday."

Ed Boyle, Pittsburgh, Pa.—"My business going at top speed. I'm moving to bigger quarters."



MAIL THIS COUPON • NO SALESMAN WILL CALL

FOLEY-BELSAW INSTITUTE, 11150 Field Bldg. Kansas City, Mo. 64111



Rush FREE book, "Keys to your Future."

Name _____

Address _____

City _____ State _____ Zip _____

THIS DO-ALL PRO KEY MACHINE YOURS TO KEEP!

Can add \$50 to \$100 a week to your income... and doesn't cost you a penny extra!

FREE

NOW! Woodmaster lets you PLANE, MOLD & SAND

with the Precision Control of **Infinitely Variable Power-Feed!**

NOW AVAILABLE IN 12" & 18" MODELS



Total Control!

Just a twist of the dial gives you from 70 to over 1,000 cuts-per-inch! You can sail through even the toughest oak at higher speeds or slow it down to handle those "hard to work" pieces like curly maple, knotty cedar and more. Perfect for molding work where profiles make sanding impossible.

New "Morse-Taper" Quick Change Head!

Unique system lets you move from planing to molding in less than 10 minutes. Cutterhead bearings (in massive, cast-iron housings) remain factory set at all times! This same system lets you quickly convert your Woodmaster to a power-feed drum sanding machine. Saves hours of tedious hand sanding!

Mail the Coupon below or...
Phone Toll-Free 1-800-538-4200, Ext. 2318



Woodmaster Tools—Dept. PW18
2908 Oak—Kansas City, MO 64108

YES! Please rush me your FREE Information Kit on Woodmaster's 12 and 18 inch planer/molders, including details on your 30 DAY FREE TRIAL GUARANTEE!

Name _____

Address _____

City _____

State _____ ZIP _____

EDLCO

Appalachian Hardwood Specialists

21 species

Domestic Hardwoods
Softwoods

Kiln Dried Delivered Prices
Catalogue \$2.00

Write Today EDLCO
Box 5373 W
Asheville, N.C. 28813
Phone (704) 255-8765

We Know Our Lumber

EDUCATIONAL LUMBER CO., INC.



RENOVATOR'S SUPPLY

Manufacturer & Importer of fine hardware, plumbing, and lighting. For catalog, send \$3.00 to:

THE RENOVATOR'S SUPPLY
4660 Renovator's Old Mill
Millers Falls, MA 01349

The best way to choose the right hardware.

Our *Classic Hardware* 40 page, color catalog takes out the guesswork by showing every item full size.

Choose from the finest English made Solid Brass hardware. Many pieces can be called "original" as the same molds have been used for over 100 years.

Write today for your catalog: \$1.00.

Dept. H10
Garrett Wade Co.
161 Ave. of the Americas
New York, NY 10013



BUILD AN HEIRLOOM CLOCK

Finest Quality Available
Kits, Movements and
Plans

Write or Call for
Catalog \$2
1-800-328-6445
Kuempel Chime
Clockworks

Dept. 014
21195 Minnetonka Blvd.
Excelsior, MN 55331

Serving clockmakers for 65 years



THE SOURCE

WOODWORKERS TOOLS & HARDWARE

7305 Boudinot Drive
Springfield, VA 22150

FREE
FREIGHT

US 800-452-9999 VA 800-468-1778



TR-30U
Trim Router

\$72-



AP-10
10" Portable Planer

BOTH for \$409

\$339-

3/8" REVERSIBLE
HIGH-TORQUE DRILL
IN CASE



\$99-

W/O CASE
\$95-

1175
3/8" PROFESSIONAL
VARIABLE SPEED
REVERSING HOLDON* DRILL

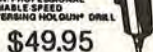

\$49.95



BLACK &
DECKER



3310
1-1/2 HP
PROFESSIONAL ROUTER

\$139

VIRUTEX 0-81
JOINING MACHINE



\$279-

SPLINES

5m-Md-Lg
1,000 per CTN.

\$27.50

WE BEAT ANY PRICE THIS ISSUE

SEND \$3.00 for CATALOG

Full Size Plans



Build these two great Fords. The Model A is 11", The Pickup is 12". Two plans per set. Plan No. 18010....\$8.50. Catalog \$1.00 or free with order. Visa/MC (516) 462-6228.

ARMOR, Dept. L, Box 445, E. Northport, NY 11731



NEW! 3-Speed Precision SHAPER
complete with
Sliding Table!
30-Day Free Trial!
FREE FREIGHT!

Power, precision, versatility put this heavy-duty shaper in a class by itself! Send for free facts on why this low-cost tool outperforms machines costing hundreds of dollars more.

CHECK THESE STANDARD FEATURES!

- SLIDING BALL BEARING TABLE for perfect end-grain cuts time after time.
- 3 SPEEDS to cover a wide range of work.
- MASSIVE 3/4" PRECISION GROUND SPINDLE for perfect, chatter-free cuts.
- ACCURATE SPINDLE ELEVATION — Smooth, positive and capable of micro-adjustment.
- VERTICAL AND HORIZONTAL HOLD DOWNS included as standard.
- POWERFUL 2HP MOTOR

Write or call today for complete facts on how you can try this precision shaper in your own shop for 30 days without risk!

Call Toll-Free 1 (800) 538-4200, Ext. 3301
KITTY PRECISION TOOLS, Dept. MW01
2908 OAK, KANSAS CITY, MO 64108



Yes, please rush complete facts on the KITTY Precision Shaper plus details on your 30-day trial and 2-year warranty.

NAME _____
ADDRESS _____
CITY _____ STATE _____ ZIP _____

Sleeveless DRUM SANDER

NO PRE-MADE SLEEVES TO BUY

ECONOMICAL — Simply cut sandpaper from standard size sheets
UNIQUE — Twist of key tightens sandpaper to drum.
SPONGE RUBBER backing insures long wear of sandpaper



1" x 3" long	\$13.50
2" x 3" long	\$15.50
2 1/2" x 3" long	\$16.00
3" x 3" long	\$17.50
1" and 2 1/2" Above \$27.00		
Above 4 Drums		\$55.00
3/4" x 3" long	\$14.50
2 1/2" x 4 1/2" long	\$21.00
3" x 4 1/2" long	\$22.50
2 1/2" x 6" long	\$25.50
3" x 6" long	\$27.50
Add \$2.50 Per Order For Shipping		

AVAILABLE WITH:

- 1/2" Bore with 1/2" or 1/4" shaft
- 1/2-20 RH Thread except 1/4" x 3"
- 3/8" Bore except 1/4" x 3" and 2" x 3"

USE ON:
Drill Press
Small Motor
Lathe, Combo-Tools,
Radial Saw, 1/4" Drill



Send Check or Money Order to:

SINGLEY SPECIALTY CO. INC.

P.O. BOX 5878, GREENSBORO, N.C. 27403
CALL: (919) 852-8581

SIGNCARVING IS PROFITABLE!

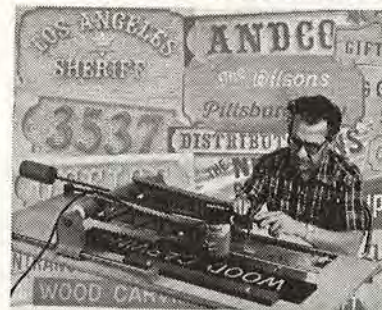

And it's easy, if you use the Marlin Woodcarvers and accessories. You can carve signs quickly at home or at swap meets. The machines do the work, the operator has the fun and profits.

No Special Training Is Required!

SEND \$1.00 FOR OUR BROCHURE AND PRICE LIST, AND BEGIN TO PLAN YOUR FULL OR PART-TIME BUSINESS.

Fine Carving Machines Since 1971

MARLIN INDUSTRIES

RR 70, BOX 191, DEPT. D76
CASHIERS, NC 28717
(704) 743-5551



WOODWORKERS HARDWARE

WHOLESALE ORDER FORM

Pt. No. Price Pt. No. Price Pt. No. Price

<p>WOOD WHEELS</p> <p>W075 100 3/4" \$3.50/100 W087 100 7/8" \$4.70/100 W100 100 1" \$6.00/100 W125 100 1 1/4" \$8.00/100 W150 100 1 1/2" \$11.00/100 W175 100 1 3/4" \$15.60/100 W200 100 2" \$19.50/100 W225 20 2 1/4" \$7.30/20 W250 20 2 1/2" \$8.80/20 W275 20 2 3/4" \$10.20/20</p> <p>WHEEL PEGS</p> <p>AP1 fits 1"-2" \$4.10/100 AP5 fits 2 1/4"-2 3/4" \$1.98/20 1741 4" PLASTIC SPOKE WHEEL \$9.00/ea</p> <p>LITTLE PEOPLE 2-3/8" Birch</p> <p>LP3 Men \$2.46/10 LP4 Women \$2.46/10</p> <p>TOY CARGO</p> <p>433 Pickle Barrel \$2.31/10 434 Oil Drum \$2.31/10 435 Milk Can \$2.15/10</p> <p>JIGGLE EYES</p> <p>88060 1/4" \$1.40/144 88010 3/8" \$1.70/144 88120 1/2" \$2.00/144 88200 4/5" \$4.10/144</p> <p>BIRCH PEGS</p> <p>MGP1 3-3/8" \$2.27/ea 7226 3 1/2" \$15.00/100 1770 3-3/8" \$1.18/ea 1771 2 1/2" \$1.17/ea</p> <p>MINI PEG</p> <p>7227 1 1/4" \$1.11/ea SKP2 3/8" \$1.30/ea Oak 3 1/2" \$28.00/100</p> <p>BIRCH SPINDLES</p> <p>S6 5 1/4" \$1.42/ea S85 9" \$1.72/ea S110 11" \$1.17/ea</p> <p>GALLEY SPINDLES</p> <p>S1 Birch 1-1/8" \$1.10/ea S1Oak 1-1/8" \$1.12/ea S4 Birch 1 1/2" \$1.17/ea S4Oak 1 1/2" \$1.24/ea</p> <p>DOWEL PIN</p> <p>1142 Birch \$1.90/100 1/4" x 2" \$8.50/500 1382 \$2.00/100 3/8" x 2" \$9.00/500</p> <p>GAME PEGS 3/16"x1"</p> <p>316N \$1.20/100 \$9.95/1000</p>	<p>SCREW HOLE BUTTONS</p> <p>1432 3/8" \$1.76/100 Birch \$7.50/500 1434 1/2" \$1.76/100 Birch \$8.00/500 1452 3/8" \$3.70/100 Oak \$15.50/500 1454 1/2" \$3.80/100 Oak \$16.00/500</p> <p>WOOD CANDLE</p> <p>CC1 1 1/2" \$3.11/ea</p> <p>BRASS PLATED CUP</p> <p>718 1-13/16" \$18.00/100</p> <p>BRASS EAGLES 2"</p> <p>878 \$2.16/10</p> <p>CLOCK MOVEMENT W/HANDS</p> <p>Q-82 1-4 \$6.48/ea 5-9 \$5.10/ea 10-24 \$4.55/ea 25+ \$3.95/ea</p> <p>CLOCK DIAL</p> <p>1772 5" \$1.80/ea</p> <p>CORD SETS</p> <p>CS6 6' \$1.00/ea CS8 8' \$1.10/ea</p> <p>PUSH-THRU LAMP SOCKET</p> <p>940 \$1.49/ea</p> <p>LAZY SUSAN BEARINGS</p> <p>LC3 3" \$0.69/ea LC4 4" \$1.00/ea LC6 6" \$2.05/ea 12C 12" \$5.99/ea</p> <p>CLIPBOARD CLIPS</p> <p>L5 3" \$0.55/ea ST6 6" \$0.75/ea</p> <p>MAGNETIC STRIP</p> <p>120A 120"x1/2" \$4.40/Roll</p> <p>CORK SHEETS</p> <p>C31 8 1/2"x11" \$0.60/ea</p> <p>PLASTIC GLASS</p> <p>357 5"x7" \$0.35/ea 380 8"x10" \$0.65/ea 314 11"x14" \$1.20/ea</p> <p>SHELF PINS</p> <p>517 \$5.40/100</p> <p>BRASS PLATED PICTURE HANGER</p> <p>S23 \$4.70/100</p> <p>MINI HANGER</p> <p>7247 5/8" \$2.60/100</p>	<p>SAW TOOTH PICTURE HANGERS</p> <p>S59 1-5/8" \$4.17/100 S60 2 1/4" \$4.50/100 406 Self Fastening \$4.77/100</p> <p>PRONG HANGER</p> <p>7248 \$2.90/100</p> <p>SOLID BRASS CUP HOOKS</p> <p>812 1/2" \$6.70/100 858 5/8" \$7.60/100 834 3/4" \$8.60/100 835 7/8" \$8.70/100 836 1" \$10.60/100</p> <p>6" BRASS & PORCELAIN HOOKS</p> <p>6417 Three Prong \$5.85/ea 6416 Two Prong \$2.97/ea</p> <p>BLACK HAMMER HINGE W/SCREWS</p> <p>1730 \$1.62/2 \$7.17/10</p> <p>BRASS PLATED HINGES</p> <p>910 1" \$1.30/10 928 1 1/2" \$2.25/10</p> <p>Screws for Above F124 \$2.40/100</p> <p>PRODUCTION SCREWS</p> <p>#6275 1"x#6 \$1.50/100 #6277 1-1/4"x#6 \$1.70/100 #6278 1-5/8"x#6 \$1.90/100 #6279 2"x#6 \$2.50/100 #6280 2-1/4"x#7 \$3.10/100 #6281 2-1/2"x#8 \$4.60/100 #6282 3"x#8 \$4.75/100</p> <p>CARPENTERS GLUE</p> <p>E705 \$11.37/Gal</p> <p>SAND PAPER SHEETS 9"x11"</p> <p>81220 220gr \$16.75/100 81150 150gr \$16.80/100 81120 120gr \$16.90/100 81100 100gr \$17.20/100 81080 80gr \$11.50/50 81060 60gr \$11.60/50 81050 50gr \$11.70/50 81234 Assort \$16.50/70</p> <p>SANDING BELTS</p> <p>3"x21"</p> <p>1700 120gr \$12.20/10 1701 80gr \$13.00/10 1702 50gr \$13.50/10 1703 36gr \$14.65/10 3"x24"</p> <p>1704 120gr \$13.10/10 1705 80gr \$13.50/10 1706 50gr \$14.60/10 1707 36gr \$15.85/10</p>
---	---	--

ASK WOOD

Continued from page 82

HELP IN CHOOSING CIRCULAR SAW BLADES

Q. Can you give me a rundown on saw blades? I would like to know, for example, what type of blade would be best for general cutting, or which ones work well for cross-cutting and ripping.

— Leonard Caton, Boulder, Colo.

A. Leonard, start by hanging the blade that comes with a new saw on the shop wall. Use it only when you have rough cutting to do.

Now, you've got a decision to make. You can select a separate blade for ripping, another for cross-cutting, and additional speciality blades as needed. Or, you can buy a combination blade designed for both ripping and crosscutting. A good one should handle most, if not all, of your basic cutting needs.



RIP BLADE



COMBINATION BLADE

Some woodworkers prefer blades with carbide tips. Although they cost more initially, the carbide teeth stay sharp many times longer than standard steel blades.

There's no hard and fast rule on tooth numbers. Generally, for a 10" diameter blade, look for about 24 to 30 teeth in a rip blade. In some cases, a 12-tooth blade may work well and put less load on the saw. Consider 40 to 60 teeth for general crosscutting chores. Special plywood or veneer blades will have even more teeth. Slots cut into blades allow for expansion when they heat up. This helps reduce warping, heat distortion, and "walking" during cutting.

Most blades can be used interchangeably on radial arm and table saws. However, avoid rip blades with high tooth angle (30°) on a radial arm saw. Blades with high tooth angles tend to cause more lifting of the work piece off the table when cutting. This increases the chances of the work kicking back toward you when ripping.

BLADE DOESN'T STAY IN POSITION

Q. I have a Craftsman 10" table saw, model # 113.295702. When I use my 7" adjustable dado blade on it, I set the proper blade height at the start. But before I get through the job, the cutting height will be lower. What's causing the problem?

— Russell Simpson, Winston Salem, NC

A. Russell, we shared your letter with our project builder, Jim Boelling. He suspects your problem may be caused by wear or sloppy fitting between the

Continued on page 86

ORDER TOLL FREE 1-800-441-9870 MN 1-612-472-5544 7 AM - 6 PM Central

Send \$1.00 for Catalog or \$5.00 for Catalog plus Best Selling plan package (\$10.00 value) or order directly from this ad by phone or mail. HOW TO ORDER: State quantity, part number, item, price, and total of order. Send check, money order, or Visa or M.C. number and Exp. date. Shipping: \$25.00 to \$49.99 add \$3.50, \$50.00 to \$99.99 add \$4.50, Over \$100.00 add \$5.00. MN. Res. add 6% tax. Minimum order \$25.00 send me: Catalog \$1.00 Catalog and Plan Package \$5.00

Print Name _____ Phone # (____) _____
 Address _____
 City _____ State _____ Zip _____

Makita

6012 HDW	3/4 C/less Clutch Drill	\$ 95.00
2708 W	8" Table Saw w/c blade	198.00
3601 B	1 1/2 hp. Router	119.00
9820-2	Blade Sharpener	165.00
6071 DWK	V.S. C/less	103.00
1900 BW	3/4 Planer	91.00
9505 BH	Kit Grinder	89.00
9900 B	3x21 Belt Sander	119.00
GEO 600	Grinder	63.00
*LS 1430	Mitre Saw	399.00



LS1000
10" Mitre
\$197



3612 BR
3 h.p. Router
\$173

★ Cordless Tool Specials ★

Call for lowest prices on Makita battery tools.

Batteries:

7.2 Volt **28.00**
9.6 Volt **30.00**

freight prepaid
C.O.D.'s add \$1.90

Orders only Call:
1-800-362-7227
dial tone then 740
608-273-0148

WORKBENCH TOOL CO.

2833 Perry St.
Madison, WI 53713

*freight collect

WOODWORKERS

Milwaukee

CORDLESS SCREWDRIVER
HEAVY DUTY REVERSING



6539-1

1 HOUR FAST CHARGE
With Battery Pack & Charger

SALE \$59.95 ppd

FREE CATALOG SUBSCRIPTION
WITH PURCHASE.

CATALOG ONLY.

2 year subscription (8 issues) \$4.00.
Free \$5.00 gift certificate with catalog order.

R. A. NESS & CO.

THE WOODWORKERS EMPORIUM

8888 N. MILWAUKEE AVE.

NILES, IL 60648

(312) 824-0565



From Europe... The Ultimate in

HISTORIC SHIP MODEL KITS.

Plank-on-frame Construction



World famous kits from Artesania Latina, Mamoli, Mantua/Sergal and more: large, magnificent replicas (many over 4 feet long!) with beautiful walnut and mahogany planking, fittings and details exquisitely cast in bronze, brass and rare hardwoods. Large scale plans, step-by-step instructions, all materials included.

Send for 88-pg. full-color catalog only \$1.00

MAIL THIS COUPON TODAY!

MODEL EXPO, INC. Dept. BHW-575

23 Just Road, Fairfield, N.J. 07007

Please send me a full color ship model catalog. \$1.00 is enclosed.

Name _____

Address _____

City _____

State _____ Zip _____

NOW A 44" WIDE DRUM SANDER AT A NEVER BEFORE PRICE

INSTANTLY ATTACH TO A RADIAL SAW OR A SANDER KIT STAND



A SPACE SAVING ATTACHMENT

- Rigid open end design insures precise thickness dimensioning over 44" width.
- Sanding drum with built-in sandpaper fasteners — no adhesives required
- Vacuum dust collector
- Money back guarantee



Wood-Mizer®

Portable Bandsaw Mills



Now! 5 Models Available

EFFICIENT less horsepower produces more lumber per log

SAFE guarded bandsaw blade

PRECISE smooth surfaces and accurate dimensions

CUTTING CAPACITIES up to 33" long by 32" dia.

Buy

direct from the world's largest manufacturer of Portable Bandsaw Mills at any Factory Sales Locations



For catalogs on our complete product lines, send \$1.00 to:

Wood-Mizer® Products Dept. QQ11

8180 W. 10th St. Indpls, IN 46214 (317) 271-1542

For a free brochure call or write
PERFORMAX PRODUCTS

17065 Judicial Rd.

Dept. W-57, Lakeville, MN -55044

1-800-334-4910/MN. (612) 435-6780

DEALER INQUIRIES INVITED

Now! All The Advantages of 5 Independent Tools In One Compact Shop!



- Table Saw
- Planer
- Jointer
- Shaper
- Slot Mortiser

NEW K5

30-DAY FREE TRIAL!

At last, a compact, full-feature shop with *separate* tools for *separate* jobs! With a K5 in your shop, you move quickly from one tool to the next... eliminates time-consuming changeovers. You get all the advantages of independent, "no-compromise" tools plus the economy of a single, powerful drive motor! Experts agree, the K5 gives you the five *most useful*, *most needed* functions in woodworking... far more for your money than any other combination tool!

30-DAY FREE TRIAL!

Write or call today for free facts on why over 250,000 woodworkers, worldwide, have chosen the K5. See how you can try the K5 for one full month without risk!

Call Toll-Free 1(800) 538-4200, Ext. 3201
KITTY PRECISION TOOLS, Dept. KW01
2908 Oak, Kansas City, MO 64108



Yes, please rush full facts on the complete K5 Shop plus details on your 30-day trial and 2-year warranty.

NAME _____

ADDRESS _____

CITY _____ STATE _____ ZIP _____

Good news!



DML forstner bits...

DML forstner bits are guided by the outer rim — which allows you to bore overlapping holes for large mortise joints; bore pocket holes; bore angled holes; and bore half-holes off the edge of the material.

When you see how its two cutting edges clear chips quickly; its full range of 15 sizes (all with $\frac{3}{8}$ " shank and $3\frac{1}{2}$ " overall length); its versatility in wood boring... then you'll see the quality in DML's new line of precision-crafted forstner bits.

...and spur bits

More news: DML's spur bit. Designed for boring large diameter holes. Multiple spurs prevent tear out. A single chip lifter shaves wood away and cuts through your toughest

material, for fast chip clearance and a clean finished cut. And a center guide point keeps your work on target.

Master-crafted of a tough alloy steel. With a $\frac{1}{2}$ " shank. A 6" overall length. In 16 sizes. A tool to get you through the tough wood boring jobs. Every time. Spur bits, from DML — the premier supplier of tooling to the wood-working industry for over 50 years.

1-800-233-7297 (SAWS)

DML
America's quality tool maker

DML, Inc.
1350 S. 15th Street
Louisville, KY 40210

Information



Send for hundreds of useful low-cost booklets and ideas, especially prepared to help you by the nation's leading manufacturers. Complete the coupon on page 97 and send with your remittance to our Better Homes and Gardens® WOOD magazine processing center.

Special section starts on page 89.

MAIL YOUR ORDER TODAY!

ASK WOOD

Continued from page 84

machine threads on the elevation shaft and the threaded hole-pin assembly in the trunnion supporting the arbor. If these parts fit somewhat loosely, vibration of these parts during operation may allow the arbor and blade to fall. New saws may also have this problem if the parts haven't been machined within tolerance. Any play, however minimal, may be enough to cause this kind of problem.

To minimize the problem Jim suggests you try these tips:

1. Always lower the blade first, then raise it to cutting height. This keeps positive weight on the machine threads and reduces the likelihood of the saw dropping during use.

2. If the saw has a locking knob in the center, or outside of the hand wheel, tighten it securely after you've done step 1.

If these steps fail, take the saw to a reputable service center and find out what parts need to be replaced.

POPULAR PUZZLE BLOCK

Q. *I made the puzzle block shown on page 46 of your February 1987 issue. I liked it so well that I made several for Christmas gifts. The gifts were so well received by my friends that I wonder, would there be any problem if I made more and sold them? Would the same apply to other projects shown in past or future issues?*

— Earl W. Beers, Meriden, Conn.

A. Earl, we're delighted you and your friends enjoy the puzzle block. Please feel free to make, give away, or sell as many projects from WOOD magazine as you like.

Our copyright does prohibit copying or republishing of the material, including project plans, in other publications. 🍄

Illustrations: Jim Stevenson

SHOP SENSE

MAKE YOUR OWN HOODS TO COLLECT DUST

If you have newer power tools, they may already have dust collection hoods attached. If they don't, you can buy original equipment hoods for many power tools from their manufacturers. Companies and dealers selling dust collectors also have ready-made hoods of heavy-duty plastic or sheet metal available with 4", 5", or 6" collars. You can adapt these to fit radial arm saws, table saws, and other tools. They'll cost anywhere from \$40 to \$80. Multipurpose fittings, called *straight hoods* and *side hoods*, cost about \$30. You also can make your own for about half the price of ready-mades.

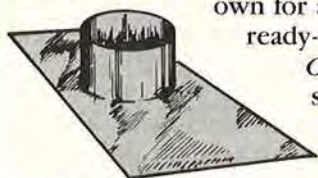

Sheet metal catcher strip with attached collar

Catcher strips, made from a strip of sheet metal with a collar attached to match your duct work, enable you to make your own custom hood. You

simply cut the sides of your hood from plywood to the shape you need and attach the catcher strip to the edges. Then, seal the joints airtight with caulk or silicone and you're in business!

RADIAL ARM SAW

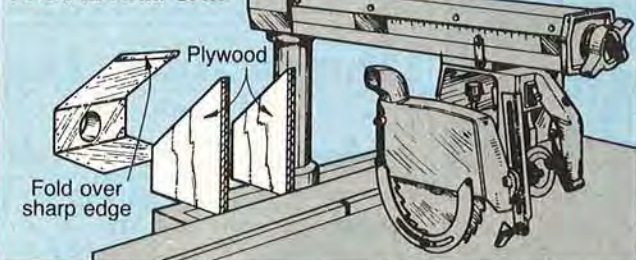

Plywood

Fold over sharp edge

PLANER

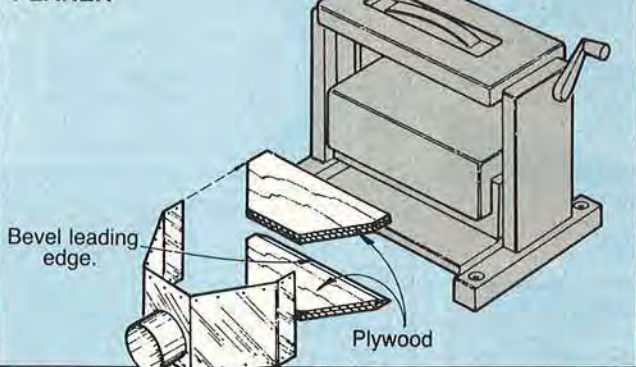

Bevel leading edge.

Plywood

A sheet metal shop can assemble catcher strips for you. Or, order them from Murphy-Rogers, Inc., 2301 Belgrave Ave., Huntington Park, CA 90255. Their strips measure 9x36", cost \$14, and have either 4", 5", or 6" collars to fit your ductwork. For details, call 213/587-4118. ♣

Illustrations: Bill Zaun

SQUARE IT™

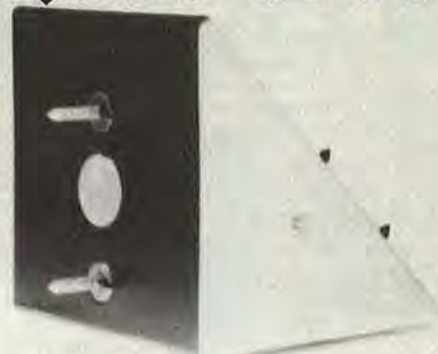

Square it™ is a newly patented electronic precision square with a guaranteed accuracy of 5/10,000 of an inch. Designed, engineered & made in America, **Square it™** is a rugged 3/4 pound precision instrument that's totally portable & built to last. **Square it™** is preset at exactly 90° & 45°. **Square it™** fulfills a universal need of woodworkers to square any tool easily & with great accuracy. There is never a guess or a question of accuracy with **Square it™**, when the light goes on you know its precisely 90° or 45°. **Square it™** will perfectly square the following tools: Table saw, Radial arm saw, Jointer, Bandsaw, Drill Press, Shaper, Disk Sander, Belt Sander, Router, or any stationary machine or hand held tool where a 90° or 45° relationship should occur. The introductory special of **Square it™** comes complete with: accuracy documentation papers, 18 page manual, Krypton bulb, Alkaline batteries and a 100% warrantee, \$76.50 ppd. The **Square it™** manual is fully illustrated with detailed drawings & easy to follow step by step instructions for a quick & accurate squaring up of your shop tools. (Example, squaring up for a table saw 10-15 seconds, Jointer 30-45 sec., Radial arm saw 35-60 sec.) For manual alone please send in \$5 check. For both **Door Shop™** & **Square it™** manuals send in \$8.50 check.

Dealer inquiries are invited.

THE DOOR SHOP™



The original Ogee **DOOR SHOP™** as featured in WOOD MAGAZINE (MAY/JUNE 85) is complete with stile & rail, slot & panel raising bits for the 1/4" chuck router. Bits are carbide tipped & BB & will make 3/4" thru 2 1/4" thick raised panel doors. **Door Shop™** & Manual \$89.50 ppd. The 1/2" shank **Door Shop™** now available. Call about our 5 piece **Door Shop™** special.

The 37 page **DOOR SHOP™** MANUAL is clearly written and beautifully illustrated with over 156 detailed drawings covering the complete process of door building. Each section covers proper methods and exact set ups for the router, including how to recognize and correct for errors. There are sections covering Design, Lumber selection, Measuring, Panel Raising, curved & straight Rail and Stile cutting & fitting, Guides, Clamping, Gluing and Finishing. This is the most comprehensive manual out today. When purchasing the **Door Shop™** manual for \$5.00 you also receive Zac's 26 page Router bit and Shaper cutter catalog free.

Zac's carbide tipped **PANEL RAISER™** router bits come in 3 styles; OGEE, COVE, & PROVINCIAL. All 1/2" shank bits are 3 1/2" in diam., with BB & give a full 1 1/2" raised panel \$90 @ or all 3 bits for \$235 ppd. All 1/4" shank bits are 2" in diam. & give a 1" or larger raised panel cut. \$65 @



COVE

TO ORDER
CALL 800-
441-0101

IN NY 212-
645-9494

ZAC PRODUCTS INC. 34 Renwick Street NYC, NY 10013

POWERMATIC



Call For Our Low Prices! We carry the entire Powermatic line at very attractive prices. Please call for our prices on the Model 66 and other Powermatic machines. You'll be glad you did!

Model 66 Table Saw with 50" Biesemeyer Rip Fence, 3HP, 1PH or 5HP, 3PH motor

MINI MAX . . .

We believe the MiniMax Elite Craftsman Series is simply the best line of new machinery to be offered to the U.S. woodworker in years. Please call or write for more information on any of these fine tools.

- FS35 13 1/2" Jointer-Planer \$2195
- C30 Combination Machine \$2995
- S45 18" Bandsaw \$1099
- Pro 32 12 1/2" Bandsaw \$ 615
- T120 47" Lathe \$ 948



WE DIDN'T BELIEVE IT until we actually used it. This tool works really well — as well as any planer we've used, except on a smaller scale. 10" width of cut, 13 amp. motor powerfeed. **CALL FOR OUR PRICE.**

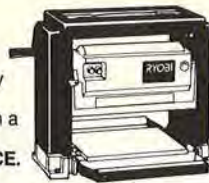

FREUD'S NEW BISCUIT JOINTER!!

Freud's new biscuit jointer allows quick, accurate assembly of cabinets, furniture and even picture frames at a fraction of the time as conventional methods. Works at 90° and 45°, includes carbide-tipped cutter and carrying case. We're introducing the JS100 at an extremely low price. Quantities are limited and this offer will expire June 30, 1987.

- JS100 Plate Jointer Call for price
- JS020 100 Biscuit \$29.00
- F1100 Spare Cutter \$34.95



THE XYLOPHILE'S COMPANY

138 E. Loudon Ave. • Lexington, Ky. 40505
(800) 354-9083 M/C VISA

FREUD SPECIALS

WC-106	6 Pc. Chisel Set	27.00
WC-110	10 Pc. Chisel Set	47.00
TT-108	8 Pc. Turning Tool Set	47.00
90-100	15 Pc. Router Bit Set	134.00
92-100	26 Pc. Router Bit Set	284.00
94-100	5 Pc. Router Cabinet Set	179.00
FB-100	16 Pc. Forstner Bit Set	159.00
EC-900	5 Pc. Shaper Cabinet Set	289.00
EC-209-213	Raised Panel Cutters	77.00
EC-260	3/4" Cabinet Door Set	157.00

Sawblades

LM72M	10", 24T, Rip Blade	34.00
LU73M	10", 60T, ATB Cutoff	34.00
LU84M	10", 50T, Combination	36.00
Set of Three Above		99.00
LU82M	10", 60T, Triple Chip	42.00
LU85M	10", 80T, Super Blade	59.00
DS306	6" Dado	90.00
DS308	8" Dado	99.00

We carry the entire line of Freud shaper cutters and router bits at discounts up to 30%. Please call for prices on these items.

Freud Orders over \$35 are prepaid.



Love At First Sight

Scale woodworkers will fall in love with this 1" scale miniature of an 1849 CONCORD STAGE COACH. **FULL SIZE CUTTING PATTERNS, (NOT A KIT), PHOTOS, ASSEMBLY VIEWS and CONSTRUCTION HINTS FOR EASY BUILDING.** \$14.95. • Conestoga Covered Wagon/ 1893 Duryea Motor Car - the first gas auto. 1" scale. \$14.95 each. "Making Model Horse Drawn Vehicles" by John Thompson: ppk, 94 pages w/plans and techniques for miniatures. \$15.95. With this ad: 2 patterns \$25 • 3 patterns \$36.95 • All 4 items \$49.95. Please add \$2 hdlg/insur. NJ res. add 6% tax. Visa/Mastercard \$20 minimum. Tel. orders: (201) 835-9339. CRISS-CROSS BOX 324BG WAYNE, N.J. 07470

Quality EXOTIC WOOD TURNERS

Burls / Thick Planks / for Bowls / Squares

CABINET MAKERS

Individually Selected Lumber for Furniture / Boxes / Inlays
OVER 70 SPECIES

All Inquiries Welcome - Call or Write

The Berea Hard Woods Co.

125 JACQUELINE DRIVE, DEPT. 10
BEREA, OHIO 44017
216-243-4452

"It's a Matter of Pride for Both of Us"

For information about placing an advertisement in *Better Homes and Gardens*® WOOD write:

Mark Hart
WOOD Magazine
750 Third Avenue
New York, NY 10017

Or call collect:
212-551-7130

STOP BREAKING BLADES

SAVE \$ START USING

NO RISK TRIAL ORDER



Gator Tooth*

BAND SAW BLADES

- Professionally Welded
- Fast Service
- Competitive Prices
- Custom made for all makes and sizes
- Guaranteed Quality
- Free Blade Catalog
- Knowledgeable staff

BAND SAW • HOLE SAW • HACK SAW • SABRE SAW • CIRCULAR SAW

AMERICAN GATOR TOOL CORP.

111 E. MICHIGAN AVE., AUGUSTA, MI 49012
Phone (616) 731-4177

The Japan Woodworker's Catalog is . . .

loaded with the best tools you can get your hands on. In our catalog you will find a complete selection of Japanese tools for the woodcarver, carpenter and cabinetmaker. Send \$1.50 for our catalog and supplements during the next two years.

THE JAPAN WOODWORKER
1731 Clement Ave., Alameda, CA 94501
Phone (415) 521-1810

Queen Anne Leg

by
Adams Wood Products, Inc.

Prompt delivery
Any quantity
Different styles & sizes
Various woods

FREE BROCHURE

974 Forest Dr., Dept. M-1
Morristown, TN 37814

615/587-2942



Mini Max

T3, Wood Shaper

- 3H.P. 1PH
- Reversing Switch
- 3 Speed
- 22" x 37"
- Excellent Fence
- Sliding Table Included

\$1725.00
prepaid freight



CHANDLER & Co

6005 Milwee, Suite # 709, Houston, Texas 77092
(713) 683-8455 call us toll-free 1-800-247-9213

BUILD THIS CHILD'S WARDROBE



Order plans for this Shaker reproduction

The beauty of this piece is that it "grows" with the child. The 2 closet poles hold toddler clothing now, and when youngster grows into his teens the same 2 poles store blouses and shirts. A very handsome piece—finished in the country manner. Measures 23"d x 42"h x 48"w.

To order plans, send \$11.00 (Canadian residents remit postal money order in US funds) to: **HAMMERMARK ASSOCIATES, P.O. Box 201-W6 Floral Park, NY 11002.** Send \$1.00 (deducted from your first order) for catalog, included free with all Wardrobe plans orders.

Information

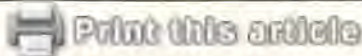

WORTH WRITING FOR

You can get useful ideas and product information by mail. Use the coupon in this section to order your choice of literature listed below.

POWER TOOLS

SCROLL SAW AND LATHE INFORMATION — More than 20 pages of information, including full-color photos, on HEGNER precision scroll saws, HEGNER lathes, and HEGNER duplicators. Find out why these machines are considered state of the art, and what to look for when shopping for scroll saws or lathes. AMI, LTD. \$1.00. *Circle No. 3.*

WOODWORKING PROFESSIONALS ONLY — Now save 50% on machinery, 70% on operating costs! How? By using the world's finest production quality universal machine. Commercial durability, utmost precision, set-up in seconds. No other tool combines usable capabilities like FELDER. Thousands sold all over the world. Now available in America through AMI. Send for brochure. AMI LTD. \$1.00. *Circle No. 4.*

ANDREOU INDUSTRIES—INTRODUCING MINI MAX—Send for our complete woodworking machinery catalog, also featuring Andreou Machinery, Powermatic, Freud, & many others. Full line of table saws, jointers, planers, shapers, sanders, lathes, dust collectors, bandsaws, vertical panel saws, overhead routers, drill presses, combination machines, cut off saws, stroke sanders, etc. We carry all sizes from small to large for all your woodworking needs. Send for catalog. ANDREOU INDUSTRIES. \$2.00. *Circle No. 8.*

NEW DELTA LUMBER COMPANY—Don't take your tree to a sawmill. Take your LUMBER COMPANY to the tree. Should you spend your money at a lumber company? Or spend it for a LUMBER COMPANY? This portable sawmill cuts boards 1/4" to 5" thick and handles logs up to 23" in diameter. For more information about your new 5 hp, 4 cycle, gas powered Briggs & Stratton sawmill, please send for a free brochure. ARONSON INDUSTRIAL SUPPLY CO. Free. *Circle No. 10.*

THE FIRST LINE IN JIG SAW — BOSCH — Bosch gives professionals a selection of top-of-the-line jig saws as well as an impressive selection of blades. Wholesale prices. Send for literature. AVIATION INDUSTRIAL SUPPLY. 50¢. *Circle No. 12.*

POWER TOOLS AT WHOLESALE PRICES—Send for free catalog. Most orders shipped within 24 hours. Pay by C.O.D., VISA, MasterCard, or check. Tools are delivered free in continental USA. BEAVER TOOL AND SUPPLY. Free. *Circle No. 15.*

DREMEL GUIDE TO COMPACT POWER TOOLS — Contains 266 pages of charts, project plans, "quick fixes", and over 425 photos on how to use all Dremel power tools. Also contains detailed information on how to use the Moto-Tool, which bit to use to cut, carve, grind, polish, sand, engrave, etc., and correct speed for best results. DREMEL, Div. Emerson Electric Co. \$7.95. *Circle No. 33.*

FREE SUBSCRIPTION TO FOLEY-BELSAW NEWS BULLETIN—For a limited time Foley-Belsaw will be giving away a 1-yr. subscription to their 64-page color publication. This publication includes stories and shop tips on all types of woodworking, tool sharpening, upholstery, engine repair, and locksmithing. The magazine, published six times a year, includes many special offers on Foley-Belsaw Co. FOLEY-BELSAW. Free. *Circle No. 41.*

BEAT INFLATION AND HIGH LUMBER YARD PRICES—Turn trees into valuable lumber with the world famous One-Man Portable Sawmill. Goes right to the trees—turns out smooth, truecut lumber every time. No crew needed, no experience necessary. Send for booklet. FOLEY-BELSAW CO. Free. *Circle No. 42.*

INCA MACHINERY INFORMATION—Complete information on the famous line of Inca Swiss woodworking machines. Designed for precision work by the small to medium sized cabinet shop. Used by thousands of hobbyists and professionals. Table saws, bandsaws, joiner/planers, dust collector, radial arm saw. GARRETT WADE CO. Free. *Circle No. 44.*

BEST VALUE IN WOOD LATHES—Wood turning has never been easier than with the 14" multi-speed wood lathe from Great Plains. Precision duplicator is standard equipment. Cast iron construction assures stability and longest-lasting service & eliminates vibration. Stainless steel ways for

smooth movement. 45 day in-shop trial. Easy terms available. GREAT PLAINS MACHINERY CO., INC. \$1.00. *Circle No. 48.*

BEST VALUES IN WOOD PLANERS—Save big with the big capacity 15"x6" planer from Great Plains. The savings from buying rough-cut lumber and sizing & finishing in your own shop will pay for this machine in no time! Cast iron construction assures a lifetime of service. 45 day in-shop trial. Easy terms available. GREAT PLAINS MACHINERY CO., INC. \$1.00. *Circle No. 49.*

IF YOU ARE INTERESTED IN FINE WOODWORKING—you will not find better machinery than that sold by J.P. Humfrey Ltd. For example, we have 10-in. general tablesaws (2 HP, magnetic switch, lever-lock fence) available at \$1,295 FOB New York. Send for brochure. J. PHILIP HUMFREY INT. \$1.00. *Circle No. 51.*

AFFORDABLE INDUSTRIAL QUALITY SANDING MACHINERY—Conveyor-fed single and dual-drum thickness sanders available in four sizes, 12, 18, 24, and 36 inches. Virtually eliminates hand sanding and improves quality, precision, and finish of your work at the same time. Plus many other products to make you more productive. Illustrated catalog and brochures. KUSTER MANUFACTURING. 50¢. *Circle No. 55.*

FROM CURVES TO CORNERS, KUSTER'S OSCILLATING VERTICAL SPINDLE SANDER GETS YOUR WORK INTO SHAPE—Industrial quality and utility priced to fit the small to medium shop. Easy to use with exclusive straight shank spindles and separate oscillation and rotation motors. Large non-marring table tills for total control of work position. Illustrated brochure and catalog. KUSTER MANUFACTURING. 50¢. *Circle No. 56.*

MULTI-FUNCTION MACHINE—Master Woodcraft Machine Co's Century XXI multi-function tool will challenge any wood crafter's creative horizons. Fully accessorized, the Century XXI becomes 11 precision tools, each performing the most demanding woodworking functions. Master Woodcraft Machine Co. is a division of Republic-Lagun Group, builders of high precision industrial machine tools. Send for literature. MASTER WOODCRAFT. \$1.00. *Circle No. 63.*

AMERICAN-MADE SCROLL SAWS—The RBI Hawk family of Precision Scroll Saws, 4 models to choose from. Exclusive Cam Over Quick blade change feature, 2 way tilting tabletop, 2 speed or variable speed motor. Virtually end sanding forever! Send for color brochure. RB INDUSTRIES, INC. Free. *Circle No. 84.*

AMERICAN WOODWORKING EQUIPMENT—Over 50 years of experience manufacturing first quality woodworking machinery. The RBI Woodplaner a leader in versatility and durability featuring a planer, moulder, sander, and gang saw all in one space saving machine. Two models to choose from. The RBI Joint Machine, furniture building and precision joint making made simple. Create beautiful dovetails, finger joints or mortise and tenons in seconds. Send for brochures and information. RB INDUSTRIES, INC. Free. *Circle No. 85.*

SUNHILL OFFERS TOP OF THE LINE IMPORTED MACHINES—for the serious DIY and professional woodworker. Our full line of stationary power tools is sold and serviced by over 50 authorized dealers across the U.S. Send for information. SUNHILL ENTERPRISES. \$1.00. *Circle No. 91.*

TWS MACHINERY—New catalog gives pictures and details on 3/4" shaper, 10" production saw, edge sander, buffer, planer, resaw, cutter, router bit, as well as information about new technology and new ideas. TWS MACHINERY. \$3.00. *Circle No. 92.*

MOULDER-PLANERS FROM WILLIAMS & HUSSEY—Mould, plane, and edge, convert from moulder to planer in less than 2 minutes. The W-7 series is available in 3 models for manual, power in feed, or power in feed/out feed. The units plane to a satin, almost sanded finish, produce doll house to crown sized mouldings, raised panels, and virtually any shape profile. Custom knives available up to 7" wide and 3/4" depth of profile. Rugged, well-made, dependable, and transportable. Complete with sturdy movable stand. Send for catalog. WILLIAMS & HUSSEY. \$1.00. *Circle No. 93.*

WOODWORKING MACHINERY CATALOG — Workbench Tool Co. is now offering the Powermatic 26 spindle shaper, 3 hp., 1 ph., 1/2 to 3/4 in. spindles, reversing switch for only \$1499 FOB. Send for catalog. WORKBENCH TOOL CO. \$2.00. *Circle No. 95.*

IS THIS THE WORLD'S BEST JOINER-PLANNER? — We think so and invite you to take a closer look! MiniMax's new FS-35 joiner-planer combines industrial quality with an affordable price that will appeal to professionals and amateurs alike. THE XYLOPHILES CO. \$1.00. *Circle No. 97.*

HAND TOOLS

FINE HAND TOOLS FROM AROUND THE WORLD—Our 1987 hand tool catalog features tools from the Orient, Great Britain, Germany, & right here in the U.S.A. Select from the best quality tools at a price only a volume supplier can provide. HILLER HARDWARE. \$1.00. *Circle No. 120.*

PERSONAL BRANDING IRONS — Brochure describes branding irons that enable you to put your name on your work quickly and easily. Made especially for branding wood, they are available with 1, 2, or 3 lines of copy or with your logo. Changeable date also available. NOVA TOOL CO. \$1.00. *Circle No. 160.*

THE JAPAN WOODWORKER'S 1986 CATALOG — is loaded with the best tools you can get your hands on. In our catalog you will find a complete selection of Japanese tools for the woodcarver, carpenter, and cabinet maker. Send for catalog plus supplements for next two years. WOODLINE-THE JAPAN WOODWORKER. \$1.50. *Circle No. 190.*

STAINS/FINISHES

SIMPLE SYSTEMS FOR WOOD STAINING AND FINISHING — A 24-page, 4-color booklet gives plenty of helpful tips for better results. Included are tips on how to apply a bartop finish in one day, prevent wood from yellowing, create stain colors, apply water clean up stains and finishes, and more. DEFT, INC. 50¢. *Circle No. 215.*

PEG-1000 WHOLESALE — Polyethylene glycol green wood stabilizer, 10 lbs. \$19.00 plus \$3.20 shipping. Send for additional information. GENERAL FINISHES. 25¢. *Circle No. 226.*

ARTI ANILINE DYES—Color chart features 36 colors on real wood veneer, along with price list and ordering instructions. HIGHLAND HARDWARE. \$2.00. *Circle No. 232.*

TIPS ON WOOD FINISHING — A comprehensive, 30-page booklet includes numerous tips that save time and trouble for do-it-yourselfers. Information ranges from small repairs to restoring the finish of a priceless antique. Also included is a chart showing the full range of colors available. The name of your nearest dealer is provided. MINWAX CO., INC. Free. *Circle No. 250.*

EASY WOOD FINISHING—Learn how to finish wood easily and beautifully with Watco, original Danish Oil Finish. Get a natural, hand-rubbed look in one step...one product. Full color brochure includes usage, tips, trouble-shooting, and more. WATCO-DENNIS CORP. Free. *Circle No. 270.*

PLANS

OVER 500 WOODWORKING DESIGNS — We now offer thirty-nine packets of blueprint plans and full-size patterns with both the home and commercial craftsman in mind. Enjoy making toys, games, children's items, whirligigs, folk art, plaques, magazine racks, shelves, kitchen and household items, birdhouses, plant stands, and more. Simple enough for the beginner, fun and profitable for the pro. Send for illustrated brochure plus sample pattern. ACCENTS IN PINE. \$2.00. *Circle No. 310.*

WOODWORKERS' PLANS AND SUPPLIES — Wood projects are simplified with the high quality plans, specialty hardware and other supplies offered by Armor Products. Over 100 plans are available for making toys, desks, clocks, pool tables, lamps, chests, and other furniture. Movements, dials, moldings, ornaments, and hardware also available. ARMOR PRODUCTS. \$1.00. *Circle No. 315.*

PLANS AND PATTERNS — This large selection of plans includes furniture designs, loom, spinning wheel, clocks, doll houses and furniture, cradles, toys, alphabets, bird houses, weathervanes, cedar chest, and much more. CRAFTPLANS CO. 50¢. *Circle No. 325.*

BUILD MINIATURE HORSE-DRAWN VEHICLES—The Concord Stagecoach symbol of the Old West, the Conestoga Covered Wagon, and the Prairie Schooner are some of the vehicles you can build using our plans in 1/12 and 1/8 scale. Concord Coach and Conestoga are available in full size 1" scale cutting patterns. Also English vehicles, some in 1/20 scale cutting patterns excellent for beginners. Ready-made plastic wheels available for 1/20 scale vehicles. Also books featuring from England, "Making Horse-

NEW! 18" 2-speed SCROLL SAW

**30-DAY
FREE
TRIAL!**



Use this high precision saw to make hundreds of profitable, unusual items... toys, name bars, filigree work, ornaments, tole paint figures... the list is nearly endless! See how Woodmaster's newest model, the "Liberty 18," outperforms them all!

Check These Advantages!

- **Powerful, 1/4 HP, 2-Speed Motor**—over twice the horsepower of any comparable saw! Speed changes instantly with just a flick of the switch.
- **Big, 18-inch throat capacity with 2-inch depth of cut**—plenty of room to work, even on large pieces!
- **Oversize, 124.5 Square Inch Cast Worktable** laminated with space-age Lexan. The work-pieces almost float across this frictionless surface!

Call Toll Free 1 (800) 538-4200 Ext. 2518
Woodmaster Tools, Dept. CW18
2908 Oak, Kansas City, MO 64108



YES! Please rush my **FREE INFORMATION KIT** and details on your 30-Day Free Trial Guarantee.

Name _____
Address _____
City _____ State _____ Zip _____

PRICE SHOCK!



GENERAL

Machine Only	AS LOW AS
— COMPARE — #350-1 10" Table Saw	\$920.00
— COMPARE — #160-2 Variable Speed Lathe	825.00
— COMPARE — #260-1 Variable Speed Lathe	1525.00
— COMPARE — #1180-1 6" Jointer & Stand	535.00
— COMPARE — #480-1 8" Jointer & Stand	1075.00
— COMPARE — #490-1 15" Bandsaw & Stand	605.00
— COMPARE — #130-1 14" Thickness Planer	1935.00

The Humfrey Catalog brings you concise descriptions & detailed, large-format photographs of machines representing a tradition of solid craftsmanship... all at factory-direct prices. Send for your copy now.

J. Philip Humfrey Ltd.

3241 Kennedy Road, Unit 7
Scarborough, Ontario M1V 2J9
(416) 293-8624

Drawn Vehicles" by John Thompson, who has done extensive work in this area. **CRISS-CROSS CREATIONS**. \$1.00. Circle No. 332.

PATTERNS BY DESIGN GROUP—Hundreds of interesting, useful and fun items to create for personal use or profitable sale. Our 1987 catalog contains plans for toys, games, plaques, puzzles, birdhouses, planters, furniture, and much more! All Design Group patterns are professional, "same size" blueprints. No enlarging or reducing is necessary. Simply trace outline of item onto wood and create! Started in 1977, Design Group has sold thousands of patterns to thousands of satisfied customers. Prices start at \$1.00, all patterns come with a full money-back guarantee. Wholesale and bulk prices are available on request. Fully illustrated catalog. **DESIGN GROUP**. \$1.00. Circle No. 340.

CEDAR-LINED HOPE CHEST PLANS—Build this heirloom quality chest using our complete plans and instructions. The chest uses stile and rail construction with traditional raised-panels. The original prize winning chest is built of natural pine, but can also be built with hardwood. Send for information sheet. **FINELINE CREATIVE DESIGNS**. \$1.00. Circle No. 342.

PLANS AND PATTERNS FOR WOODWORKERS—New unique woodworking plans and patterns. Select Patterns for wooden toys or novelty decorations. The plans are fully illustrated with step-by-step instructions and photos. Send for a brochure today. **FUNWOOD CRAFTS & TOYS**. \$1.00. Circle No. 343.

FULL-SIZE FURNITURE PLANS CATALOG—Illustrates and describes over 180 plans for making furniture of quality found in museums and fine furniture stores. Plans include rolltop desk, cradles, dining tables, chairs, buffets, chests, gun cabinets, poker table, children's furniture, rocking horse, spinning wheels, and more. Bill of materials explaining drawings assist the woodworker. **FURNITURE DESIGNS, INC.** \$2.00. Circle No. 345.

COUNTRY FURNITURE PLANS—Our catalog features 24 designs—from country pie safe to shaker trestle table. Also included are various products for the home workshopper. Send for our latest catalog. Price of catalog deducted from your first order. **HAMMERMARK ASSOCIATES**. \$1.00. Circle No. 370.

LOFT BED PLANS—Four plans in one, ideal for college and child's room. These versatile plans allow you to custom design the perfect space-saving loft to meet your exact needs. Whether it's a desk with a computer cabinet, storage drawers, bunk beds or space for a sofa, these plans give you all the options. Sturdy, completely disassemblable, easy to build and store. Send for complete plans. **LOFT FURNITURE CO.** \$9.50. Circle No. 384.

WOODWORKING PLANS—Catalog of full-size plans printed on heavy paper for toys, gifts, novelties, action windmills, shelves, birdhouses, garden furniture, Dutch windmill, lawn ornaments, old-fashioned lawn swing, jigsaw projects for children, and more. **MASTERCRAFT PLANS WEST**. \$1.00 (refunded with first order). Circle No. 390.

MAKING TIMELESS TOYS IN WOOD—contains 40 heirloom-quality designs, with 20 mini-plans in book. Full color, 96 pages. **SUN DESIGNS**. \$9.95. Circle No. 455.

HUNDREDS OF FREE PLANS—Timbers Woodproject Directory is described in this catalog of woodworking patterns. The directory guides you to 768 plans, 250+ are available free. Also featured are hundreds of full-size plans for antique & modern furniture, patio furniture, toys, rocking horses, whirligigs, office furniture, lamps, clocks, planters, musical banks, plus many instruction & pattern books. Premium quality wood parts at competitive prices complete this fine catalog. **TIMBERS/LAKE TAHOE, INC.** \$1.00. Circle No. 461.

TOYMAKERS SUPPLIES—Catalog of over 100 full-size wooden toy patterns—classic to contemporary designs from Packard Le Baron to Streamlined train and moon machine. Easy to follow, fully illustrated patterns which appeal to all ages. Hardwood wheels (plain or spoked), shaker pegs, axles, etc. in stock. Accessory kits of pattern and turnings available. **TOY DESIGNS**. \$1.50. Circle No. 465.

WOODWORKING/CRAFT SUPPLIES & BOOKS—Brochure of complete kits & woodworking books. Ready to assemble wood kits for dollhouses, classic cars, bird-feeders, boats, trains, trucks, wood clamps & more. Model airplanes that really fly—rubber band motored. Ready to finish contoured wood teddy bears with glass eyes & moveable limbs. Duck & shorebird decoys & wooden fruit ready to paint. **TOY DESIGNS**. \$1.00. Circle No. 466.

PROJECT PLANS FOR WOODWORKERS—Professionally designed projects include furniture, playthings, and accessories, to more complex projects such as storage sheds and gazebos. These plans are designed using readily available materials, keeping in mind standard sizes of lumber. Instructions are clear and concise, and occasionally include tips that will make your job easier. Some plans have a cut-out materials list to take with you to the lumber yard. All plans are current, and we are constantly adding to our line. Order our catalog now and get started! **THE WORKSHOP BLUEPRINT CO.** \$2.00. Circle No. 485.

LUMBER

BEAUTIFUL WESTERN HARDWOODS—Cal Oak is California's exclusive hardwood lumber producer with direct mill sales regardless of value. No broker's fees, no middle-man! Indigenous, unique & exotic woods—Black Oak, Pacific Madrone, Ten Oak, Calif. Black Walnut, Freemont Cot-

MOLD, PLANE & EDGE

... in Your Shop or On the Job!

Attention: Renovators, Hobbyists & Carpentry Professionals: Now you can save up to \$115.00 on any new W-7 Series Molder/Planer System from Williams & Hussey—just by sending for our FREE information kit!

The portable, American-made W-7 Series is one of the safest, most versatile, most economical lines of combined-function woodworking machines you can own—in your shop or out on the job!

Save on America's
Most Versatile
Molder/Planers!

Now
\$115
OFF!

Molds, Planes and Edges!

America's most versatile shop tool turns useless scrap into smooth, saleable items every craftsman can be proud of:

Picture Frames • Crown
Moldings • Raised Panels
Boat Decks • Casings
Sashes • Rails

Cuts Any Molding, Planes Any Hardwood

Duplicates thousands of moldings from 7" wide to 3/4" deep... planes 15 feet per minute (even rock maple!)... edges any width of board, thanks to the open-sided design.

Super-Fast Changeover

Your W-7 converts from Molder to Planer in less than two minutes. No gauges or special tools needed: The safety recessed blades bolt on or off in seconds—no arbor changes required!

Three W-7 Models

For power infeed/outfeed, power infeed only, or manual operation—all at 15 feet per minute and even faster using multiple cavity blades!

5-YEAR WARRANTY

100% American Made • Weighs Only 85 lbs. • Cast-Iron Base & Head • Chrome Steel Posts
Serrated Steel Roller • 2-Minute Changeover

BUILT TO GO THE DISTANCE.

Save up to \$115! Limited time only. Write or Call for FREE Information Kit!

1-800-258-1380

In NH 603-673-3446

Please rush specs on the W-7 Series Molder/Planers.

Name _____

Street _____

City _____

State _____

Zip _____



Free 30-day trial!

Williams & Hussey Machine Co.
Elm Street, Dept. 237FM • Milford, NH 03055

NOW! Get in on the PROFITS in

SMALL ENGINE REPAIR!



Work part time, full time—right at home—we help you every step of the way.

No doubt about it... as a small engine pro, you can cash in on the huge demand for qualified men in one of America's fastest growing industries. You'll be able to command top hourly rates of from \$25.00 to \$30.00 per hour—and that's just for labor. A simple tune-up earns as much as \$49.95 for less than an hours work, and parts, engines and accessories will add even more to the profits.

Plenty of business waiting for qualified men. 65,000,000 Small Engines Are In Use Today!

That's the official count from the Engine Service Assn., and one-million new engines are being built each month. With fully accredited Foley-Belsaw training, you can soon have the skills and knowledge to make top money servicing these engines. People will seek you out and pay you well to service their lawnmowers, tillers, edgers, power rakes, garden tractors, chain saws, minibikes, snowmobiles, generators, go-carts, paint sprayers, snowblowers... the list is almost endless.



Professional Tools and Equipment, PLUS 4 H.P. Engine ALL YOURS TO KEEP... All at No Extra Cost. NO EXPERIENCE NECESSARY!

You don't need to be a 'born mechanic' or have any prior experience. You can master this profitable trade right at home in your sparetime. Lessons are fully illustrated... so clear you can't go wrong, and with our famous 'learn-by-doing' method you get practical 'hands-on' experience. We also show you how to get business, what to charge, where to get supplies wholesale... all the inside tricks of the trade you need to assure success right from the start.

Send for FREE Facts—Do it TODAY!

NO Obligation—NO Salesman Calls!

You risk nothing by accepting this offer to see how easily you can learn the skills you need to increase your income in a high-profit business of your own.

Just fill in and mail coupon below (or send postcard with name and address) to receive full information by return mail.

RUSH COUPON TODAY

Foley-Belsaw Institute
51150 Field Building
Kansas City, MO 64111



FREE BOOKLET!

Send for your copy today!

FOLEY-BELSAW INSTITUTE
51150 FIELD BUILDING
KANSAS CITY, MO 64111



YES, please send me the FREE booklet that gives full details about starting my own business in Small Engine Repair. I understand there is No Obligation and that No Salesman will call on me.

NAME _____

ADDRESS _____

CITY _____

STATE _____

ZIP _____

WOODWORKING BOOKS AT DISCOUNT PRICES—Most complete listing of books for woodworkers. Each book is discounted from 10 to 25% off the cover price. There is absolutely no shipping and handling charge. Woodworking, carving, turning, project books by authors such as Krenov, Frid, Spielman, Nish, Tangerman, and Hoadley are listed along with many hard-to-find titles. MANNY'S WOODWORKER'S PLACE. \$2.00. Circle No. 880.

WOODWORKING TOOLS AND SUPPLIES CATALOG—Send for new 68-page color catalog of 783 handtools, supplies, patterns, hardwoods, toymaking, carving, turning supplies, Record-Marples, Kunz, Vt. American, Blum, Accuride, Schlagring, Solginen, U.S. Safety, General, Hempe, Boyne, Hirsh, Brinks-Cotton, Smith Whetstone, DMT. Freud tools 20% off. Walnut, cherry, basswood, maple turning & carving blocks. Solid maple & spoked wheels, toy parts, pegs, etc. 101 popular veneers, burls, crotches, large flexibles, glue sheets, fancy faces, custom made veneers. Hurry! incentive offers & introductory deals included. BOB MORGAN WOODWORKING SUPPLIES. \$1.00. Circle No. 890.

WOODWORKING TOOL CATALOGS—R.A. Ness & Co., the Woodworkers Emporium, offers a 2-year subscription, a total of eight huge sale catalogs. Thousands of industrial quality items—machinery, hand tools, portable electric tools, and supplies—are featured at super sale prices. The fee is refundable with purchase. R. A. NESS & CO., the Woodworkers Emporium. \$4.00. Circle No. 900.

RENOVATOR'S SUPPLY—America's Number One source for elegant, old-style reproductions at factory-direct prices! 48 colorful pages of door, window and cabinet hardware; lighting and bathroom fixtures; and gifts for the home in brass, oak, porcelain and wrought iron. RENOVATOR'S SUPPLY. \$3.00. Circle No. 915.

TOOLS ON SALE—A division of Seven Corners Ace Hardware Inc. offers a comprehensive catalog featuring over 190 pages of the most competitive prices in the industry. If you're looking for savings and fast delivery on over 1800 items, request our catalog. This catalog offers one of the most complete selections of power tools available anywhere from the most respected manufacturers in the industry: Milwaukee, Makita, Porter-Cable, Black & Decker, Freud, Bosch, Delta, and many more. SEVEN CORNERS ACE HARDWARE. \$1.00. Circle No. 920.

CABINET MAKERS' TOOLS AND SUPPLIES—New 224-page catalog of fine hand and power tools for cabinet makers or serious woodworkers. Also featured are three sections on hardware, supplies, and cutting tools. This catalog takes the mystery out of using European hardware. A must reference for the woodworker. THE SOURCE. \$3.00. Circle No. 935.

TOOL CITY CATALOG HAS THE TOOL OR ACCESSORY FOR YOU—The 408-page 1986-87 Tool City Catalog is the most complete mail order catalog. It features a comprehensive selection of stationary & portable power tools; hand tools, tool accessories, hardware parts, woodworking books, and shop equipment. Priced to save you money in all categories. TOOL CITY. \$2.50. Circle No. 945.

WOODWORKERS CATALOG—More than a catalog—it's one of the best sources for quality woodworking tools. You'll find everything from bit braces to wood borers, from saws to sharpening stones. Every product is sold satisfaction guaranteed. WOODCRAFT SUPPLY CORP. Free Circle No. 955.

NEW 1986/87 CATALOG IS A WOODWORKER'S DREAM—It's the ideal resource for materials often difficult to obtain, as well as items frequently used of exceptional quality. It features 114 full-color pages of specialty hardware, tools, plans, veneers, kits, finishing materials and an unconditional guarantee. Send for catalog. THE WOODWORKERS' STORE. \$1.00. Circle No. 965.

WOODWORKERS SUPPLY—Offers high quality tools and supplies for skilled, amateur, and professional woodworkers. Our complete catalog includes machinery, hand tools, plans, router bits, shaper cutters, wood specialties, and more. For your two year subscription send to WOODWORKERS SUPPLY OF NEW MEXICO. \$2.00. Circle No. 975.

KITS

CANOPY BEDS, WINDSOR CHAIRS, PLUS SHAKER AND QUEEN ANNE—museum reproductions lavishly presented with coordinated fabrics, paints, lighting, pewter, and brass. Furniture available assembled finished or ready to assemble kits. Since 1949, Cohasset Colonial is the oldest and largest manufacturer of reproduction furniture kits. State-of-the-art joinery insures easy assembly. Custom curtains, bed hangings, quilts, fishnet canopies. Color catalog subscription. COHASSET COLONIALS. \$2.00. Circle No. 1015.

DO-IT-YOURSELF GRANDFATHER CLOCK KITS—Direct from world's largest manufacturer of grandfather clock kits. Prices starting at under \$280 including West German Westminster chiming movement. Choose from black walnut, cherry, and oak. Other quality heirloom kits also available. Send for catalog. EMPEROR CLOCK CO. \$1.00. Circle No. 1030.

QUALITY CLOCK KITS AND PLANS—Handmade and semi-assembled of carefully selected 3/4 in. cherry, oak, or walnut with beveled glass. Or build from "scratch" using our detailed plans and trim pieces. Choice of quality movements. Established in 1916. KUEMPEL CHIME CLOCK WORKS. \$2.00. Circle No. 1050.

WOODEN SHIP MODELS—Discover the world's hobby—building fine-quality, historic wooden ship models. Described are true-to-life scale replicas, lifelike in every detail. A 64-page color catalog introduces you to this fascinating hobby. MODEL EXPO, INC. \$3.00 (Refunded with first order). Circle No. 1060.

MUSIC MAKER'S CATALOG—St. Croix Kits' 32-page Music Maker's Catalog contains various kits in guitar, banjo, mandolin, dulcimer and harpsichord building. Each kit is rated by skill and patience level. The projects have all been selected by Jerry Brown and all kits are completely guaranteed. ST. CROIX KITS. \$1.00. Circle No. 1080.

CLOCK BUILDERS—New 1987 catalog with everything you will need for building that family heirloom. Products include: 40 clock plans, mechanical and quartz clock movements from nine tube Grandfather to four melody quartz battery movements, dials, hardware, and all component parts related to clock building. Quantity prices available. Price of catalog refunded with first \$25.00 order. TURN-CRAFT CLOCK CO. \$3.00. Circle No. 1085.

SOLID WOOD CLOCK KITS—Full-color catalog of beautiful, easy-to-make clocks. All solid wood with solid brass pre-assembled movements. All parts hand cut for perfect assembly, even by beginners. VIKING CLOCK CO. Free. Circle No. 1090.

PUBLICATIONS

DISCOVER GUILD OF MASTER CRAFTSMAN PUBLICATIONS—Unique books and magazines for those who enjoy working wood. Plans and projects, handbooks on tools and techniques, guides for woodturners and woodcarvers, etc. Send for our free catalogue of books collected from around the world. Details of The Society of Wood Craftsmen sent with every catalogue. GUILD OF MASTER CRAFTSMAN PUBLICATIONS. Free. Circle No. 1125.

SCALE WOODCRAFT MAGAZINE—A quality publication that covers every phase of scale woodworking for beginners as well as serious craftsmen. From specific how-to articles, complete with plans and text, to handsomely reproduced portfolios of the work of master craftsmen. You'll discover their tools, techniques, methods and materials. An invaluable source of ideas, inspiration, and information. Annual subscription price is \$14.95. Sent \$1.00 for sample copy. SCALE WOODCRAFT MAGAZINE. \$1.00. Circle No. 1160.

WHAT ARE YOUR OLD TOOLS WORTH?—New illustrated Collector's Guide gives history and current dealer and auction prices for the products of Stanley, Bailey, Disston, KeenKutter, Sargent, Simmons, Winchester, and dozens of lesser known brands made from 1840 to 1940. Just a few of the over 5,000 items described and priced: adzes, anvils, axes, braces, chisels, compasses, dividers, hammers, hatchets, knives, lathes, levels, planes, plumb bobs, routers, rules, saws, screwdrivers, spoke shaves, wrenches, and wheelwright's items. Over 2,000 illustrations. First edition, 230 pages, 9x12 in. paperback, Library of Congress #84-50055. Now is the time to identify and price all of your old tools. Just one find could pay for this new book, many times over! WINDMILL PUBLISHING CO. \$14.00. Circle No. 1190.

SHOP ACCESSORIES

RADIAL ARM SAW CUTTING GUIDE—Designed for the home shop where space is limited on the job sites. Allows accurate single and repeat cuts, full use of radial arm saw. Calibrated in inches and metric. The easiest to transport. Accurate and affordable. Stores on wall or saw. AZ-CAL PRODUCTS & MFG. \$1.00. Circle No. 1210.

SHOP SHAPE-UP—Unique, versatile tool and parts storage system features tool panels, cabinets, and workbench attachments to safely store and organize your valuable hand and power tools and small parts. This very functional system offers inter-changeable tool hooks, bins, and shelves to let you custom-tailor your work area. Ideal for woodworking and hobby applications. CONCEPT 2001, INC. Free. Circle No. 1225.

RIPSTRATE SAVES FINGERS—for table saw and radial arm saw users. Brochure describes the RIPSTRATE and shows how it gives straighter cuts, speeds, the work, prevents kickbacks, and keeps hands away from the blade. FISHER HILL PRODUCTS. 25¢. Circle No. 1235.

EASY DOES IT—with HTC'S power tool accessories. Discover many unique items, designed only with you, the dedicated woodworker, in mind. Make your machinery safer, increase the working area of your shop and accomplish nearly impossible tasks easily, quickly, accurately. Full-line catalog and price list. HTC PRODUCTS, INC. \$1.00. Circle No. 1245.

CLASSIC WORKBENCH—This is a space saver's dream. Assembled & knocked down in minutes. Beautifully designed workbench is made of Danish Red Beech with a linseed oil finish. Other features include built-in, precision steel spindle rises & dogs. Send for literature. LAGUNA TOOLS. \$1.00. Circle No. 1249.

DRUM SURFACE/THICKNESS SANDER—Now a radial arm saw accessory providing inexpensive, space saving surface/thickness sanding capability. Product features include: instant attachments to all radial saws, 44 in. sanding width, sanding drum with sandpaper fasteners, and vacuum dust collection. Send for information. PERFORMAX PRODUCTS. \$1.00. Circle No. 1253.

BUILD THIS GUITAR FROM A KIT!
Only 89.95 plus 5.40 shipping



Send \$1.00 for complete catalog of the finest musical instrument kits:

- HARPS
- HAMMERED DUICIMERS
- GUITARS
- PANPIPES
- BANJOS
- PSALTERIES
- HURDY GURDY and much more!

ST. CROIX KITS
423-B South Main
Stillwater, MN 55082
(612) 439-9120

BAND SAW BLADE SPECIALISTS

SPECIAL OFFER

Buy Six Blades, Get One Free.

Band saw blades cut and welded to your exact specifications

WIDTH	TEETH	PRICE/INCH
1/8" thru 3/4"	3 thru 32	\$.04

Price=inch length x price per inch+1.75 weld charge

NO MINIMUM ORDER
Speedy Delivery
Add \$2.50 for shipping & handling
S.C. residents add 5% sales tax
Send payment with order — write or call

ROBERTS HARDWARE
P.O. Box 1276 • Taylors, SC 29687
803/879-2470



Build A Clock

Murray Clock Craft has a wide variety of quality Grandmother and Grandfather case kits, and fine reproductions of American wall clock kits and plans. Your dollar goes further — for ordering convenience, prices are quoted in U.S. funds.

Send \$2.00 today, refundable on your first order, to the address below for your 80 page catalogue. We are proud to be Canada's oldest and largest clock kit company.

Murray Clock Craft Ltd. 510 McNicoll Ave.
Dept. UB Willowdale, Ont., Canada M2H2E1 (416) 499-4531

WOOD PARTS

WOODWORKS

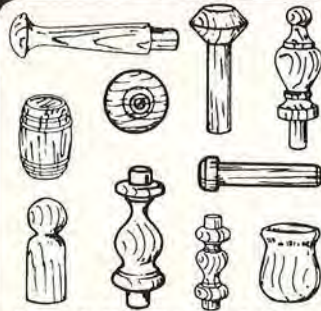

Catalog \$1.00 1st Class/Free 3rd Class
WOODWORKS

P.O. Box 14507, B-6, Ft. Worth, TX 76117
817-281-447

THIN HARDWOOD PRICED RIGHT

Clear • Kiln-dried • 2 Sides Surfaced
3" to 10" Widths • 3' to 5' Lengths
20 sq. ft. Packs, Random Widths & Lengths



- 1/2" red oak...\$36.00 pkg.
- 1/2" walnut.....\$44.00 pkg.
- 1/2" pecan.....\$29.00 pkg.
- 1/2" cherry.....\$44.00 pkg.
- 1/4" & 3/8" also available at same price.

Price includes UPS delivery in Continental USA

Send Check or M.O. with order

HARDWOODS OF ILLINOIS
RR4, Box 618, Mt. Vernon, IL 62864

AMITY
Quality Restoration Systems

ENJOY HIGH EARNINGS AS
A FURNITURE REPAIR EXPERT!
FREE 1987 CATALOG OF AMITY RESTORATION
SYSTEMS, CHEMICALS, FINISHES, MIRROR
SILVERING & REPAIR PRODUCTS

SEND \$1.00 FOR POSTAGE & HANDLING

AMITY
DEPT. 23, P.O. BOX 7204
MADISON, WI 53707

101 GIFT & NOVELTY PATTERNS

This wonderful packet contains 101 FULL SIZE PATTERNS of Giltz, Novelties, Lawn Figures, Bird Houses, Shelves, Action Windmills, Alphabets, and many more things. Just trace and saw out. Plus "Make Money Jig Sawing" Only \$7.00 Prepaid 1st Class for this big packet!



MASTERCRAFT PLANS WEST, DEPT. 55H
P.O. Box 625, Redmond, WA 98073

INSTRUCTIONS, IDEAS AND INSPIRATION



SEND \$50 FOR A CATALOG TODAY

You'll find a wide selection of plans, patterns and ideas for woodworkers of all skill levels. Everything from simple to challenging.

Craftplans™

21801 Industrial Boulevard, Dept. 948
Rogers, Minnesota, 55374-9514

30 BIRDHOUSES
FULL SIZE PATTERNS



Attractive new bird houses and feeders. Expertly designed to attract Wrens, Martins, Robins, etc. Easily made. Full size patterns and directions. Only \$7.00. Prepaid 1st Class.

MASTERCRAFT PLANS WEST, DEPT. 516H
P.O. Box 625, Redmond, WA 98073

EDGE JOINING



**NO DOWELING
NO PLANING
NO BOWING**
STURDY MAPLE STRAIGHT EDGES
FREE GLUE SHIELDS
1/2" JACK SCREWS BOTH ENDS

NO OTHER TOOLS NECESSARY!!!

ADD 13¢ EACH FOR SHIPPING
10% DISCOUNT ON TOTAL W/3 OR MORE (ANY SIZE)
VISA/MSTR.CD. ACCEPTED (EXP. DATE REQ'D.) FREE IMMEDIATE DELIVERY INFO

MARK PROD. Box 46143 Dept. W5
Bedford, OH 44146 Call: 216-232-1281

FUN WOOD
Crafts & Toys

Woodworking Plans & Patterns



Doll Cradle
22" Long
Order #Ty-CR-103
\$8.00

Funwood Crafts & Toys
P.O. Box 541Z
Coo's Bay, OR 97420



Large 24" Dump Truck
Order #Ty-Ph-102
\$9.00

Both Plans \$15.00
Brochure only \$1.00



Outdoor Chair & Loveseat

Build these durable seating pieces for deck or lawn. Corner table plans also available.

PLAN #585-W	\$8.95
TABLE #684-W	\$5.95
POST. & HANDLING	\$1.50
OUR NEW CATALOG	\$2.00
TOTAL	_____

Catalog price is refundable with next order. Iowa residents add sales tax.



P.O. BOX 65725, WEST DES MOINES, IA 50265

FREE CATALOGS

Woodworker's Supply

(OF NEW MEXICO)

5604 Alameda Place NE
Albuquerque, NM 87113
505-821-0500

Yes, please start my free 2-year subscription.

FULL SIZE

WOODWORKING PATTERNS
SIMPLE TO MAKE - FUN - PROFITABLE

✓ Check the packets of Interest to YOU!

- 125 pattern packet PLUS "Shop Secrets"
- Over 50 "Folk Art" patterns
- 8 "Wind-Action" whirligigs packet
- 40 craft plaques plus projects
- 27 toy cars, trucks, train, ferry & more!
- 6 decorative magazine racks

Send \$7.00 per blueprint packet or choose any 3 FOR ONLY \$14.00.

ACCENTS, Dept. MA57, Box 262, Danvers, MA 01923

Brochure of 500 designs \$2.00 (Free with order)

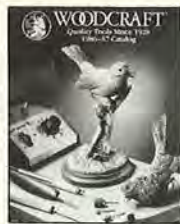

FREE Tool Catalog Quality Products For Woodworkers

Send today for your FREE copy of our new colorful catalog. It's fully illustrated with the finest quality tools, supplies, books, components, hardware, and much more. Satisfaction Guaranteed. Write today for your FREE catalog.



WOODCRAFT SUPPLY CORP.
Dept. WBH57
41 Atlantic Avenue, Box 4000
Woburn, Massachusetts 01888

MAKE WHIRLIGIGS WOOD TOYS

100's of plans, parts, kits, books, finishes & supplies for toys, whirligigs, classic autos, swing sets, doll houses, crafts & furniture. Also toy, craft, game & furniture parts in maple, oak, walnut & cherry. Bulk prices available. Color catalog subscription \$1. (614) 484-4363
Cherry Tree Toys, Box 369-409, Belmont, OH 43718



DUCK KITS
\$19.00 Precut Kit
just assemble & paint
\$15.00 Uncut Kit
just cut, assemble & paint

BUILD A CLASSIC

2 Full Size Patterns for Chrysler Sedan & Graham Bros. Truck\$10.00.
10 Spoke Wheels.....\$7.50
Catalog\$1.50



TOY DESIGNS

DEPT. BW57 • BOX 441
NEWTON, IOWA 50208

PICNIC
PATIO

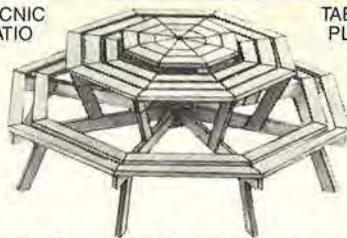

TABLE
PLAN

Imagine if you will, this exclusive piece of art made of 2x4's! A functional picnic patio table. Everyone seated is in visual and voice contact. Octagon seats 8 adults. Lazy susan, umbrella holder. 7'1" across. Fully illustrated for cutting assembling plus a material list. Patented. \$10.00 check or money order. USA \$'s. Money Back Guarantee.

THOM'S, INC. Dept. 2
2012 Wilkins • Laurel, Montana 59044



Develop a profitable second income in your spare time making small, unique bandsaw boxes. This unpublicized, little-known technique allows you to turn common inexpensive lumber and scraps into valuable utility boxes for the home and office. High demand in gift shops, stationery stores and craft fairs. Fully illustrated instruction booklet of 15 original and profitable designs. Satisfaction absolutely guaranteed. Send \$10.00 to Box-Art, Dept. P, Box 8069, Woodridge, IL 60517.

National Carvers Museum

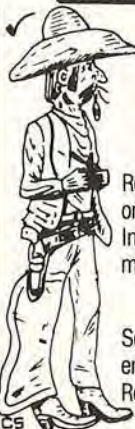

LEARN WOODCARVING AT HOME

Receive sample instructional pack on whittling and woodcarving. Includes copy of *Mallet* monthly magazine.

Send \$1.00 to The National Carvers Museum, 14960 Woodcarver Rd., Monument, CO 80132.
(303) 481-4737

EASY TO BUILD PLANS

FILE CABINETS
2 drawer and 4 drawer file cabinets.
Build in less than 3 hours. Perfect for home or office.

plan #5 \$7.00



DOG HOUSES
3 Sizes of dog house plans. Small, med and large, are weather resistant and sturdy for all types of dogs.

plan #313 \$7.00

INDOOR/OUTDOOR PLANT CONTAINERS
27 Unique and traditional plant containers, all sizes. Most can be built in less than an hour.

plan #501 \$7.50

90 DAY MONEY BACK GUARANTEE

THOMAS, DeptW10
4701 Cowden Pl.
Yakima, Wa. 98908

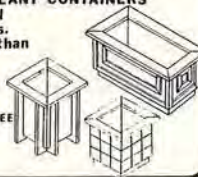

Full-Size FURNITURE PLAN 18th Century PINE CRADLE

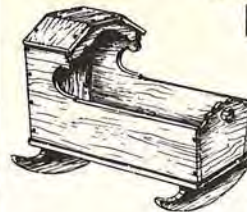

Authentic 18th Century design. All joints hand-pegged like the original. 36" long by 29 1/4" high. Perfect for fireplace wood, magazines. Baby, too! A woodworker's delight!

Order plan #120 .. \$8.00

CATALOG
180 diff., full-size prof.
furniture plans—\$2.00
(catalog free with order)

FURNITURE DESIGNS, Dept. BP-67
1827 Elmdale Ave., Glenview, IL 60025

HEGNER

The World's Best
Scroll Saws, Lathes,
and Duplicators.

Ask for our free brochures
or call
302 • 322 • 2226

ADVANCED
MACHINERY
IMPORTS, LTD.

P.O. Box 312w
New Castle,
Delaware 19720

SPECIAL OFFER

BRANDING IRON

For hard and soft wood



\$2600

Plus \$2.00 for shipping and handling
Nebr. residents add correct sales tax
SATISFACTION GUARANTEED
or your money back

- Shipped in 1 week
- Solid brass head — deep cut letters
- First Line: HAND CRAFTED BY — as above
- 2nd line: Your choice — 20 characters / spaces max.
- Compact size
- As above but with 3rd line — \$37.00 + \$2.00

ORDER TOLL FREE 1-800-826-7606 (except Nebraska)
In Nebraska 1-402-464-0511

Brochure/information call (402) 464-0511

Order by mail from: NOVA TOOL CO.

4533 Colfax Circle, Dept. BH87
P.O. Box 29341, Lincoln, NE 68529



DOWELS - PLUGS - PEGS

Manufacturer Direct
Largest & finest selection Oak, Walnut, Hickory, Maple, Cherry, Mahogany, Teak, even Treated Dowels. Quantity discounts.

MIDWEST DOWEL WORKS, INC.
4631 Hutchinson Road
Cincinnati, Ohio 45248
(513) 574-8488



DOWELS
1/4" - 2" Diameter



3 1/2" Length

SHAKER PEGS

Hard Maple
Poplar
Oak, Red or White
Walnut
Also Mini-Pegs

DUTCH WALL PEG

Hard Maple
Oak
Walnut



4" Length

Catalogue on Request



15" Scroll Saw

- Comparable to Hegner or Delta
- Fully adjustable table
- 2" depth of cut, 3/4" stroke
- 110v
- Work and storage table included at no charge. A \$49.⁹⁵ value
- 25 assorted blades included

\$199.⁰⁰

(Shp. & Hdlg. \$20.⁰⁰)

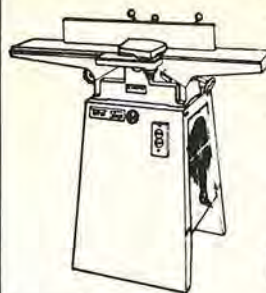

6" Heavy Duty Jointer

- 3/4 hp, 110v
- Adjustable speeds
- Fully adjustable
- 190 lbs.

Reg. \$499.⁰⁰ **\$299.⁰⁰**
(ships freight collect)

8" Industrial quality jointer also available.

Reg. \$795.⁰⁰ **\$575.⁰⁰**

(ships freight collect)

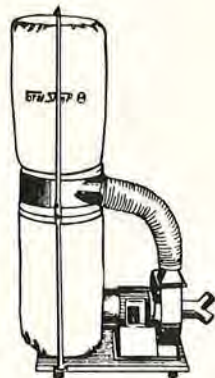

Industrial Dust Collector

- 2 hp, 110v
- Two 4" inlets
- 1185 CFM
- 125 lbs.

\$499.⁰⁰ Value **\$339.⁰⁰**
(ships freight collect)

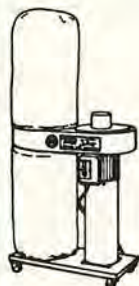

Dust Collector

- 1 hp, 110v
- 4" inlet
- Commercial quality
- Compact size

Reg. \$348.⁰⁰ **\$199.⁰⁰**
(Shp. & Hdlg. \$30.⁰⁰)



Dept. Q,
P.O. Box 17859, Greenville, SC 29606

Name _____
Address _____
City _____
State/Zip _____
Phone _____

**30-Day Money Back Guarantee
1-Year Warranty**

Call _____ or in S.C.
Toll Free 1-800-845-9356 288-4174

CREATE ANY HOLLOW CYLINDRICAL SHAPE — with 1/4 in. wall thickness, 12 in. diameter. Ring Master cuts perfect rings in any wood, any angle, any size—stack the rings and create any cylindrical shape. Just glue—sand, & finish, all on the Ring Master. Create matched sets of items. Choose from 2 models, 1 attaches to Shopsmith Mark V. RING MASTER, INC. Free. Circle No. 1265.

PROFESSIONAL SANDING EQUIPMENT — Sand-Rite's Brush Head sands mouldings and intricate carvings without losing detail or shape of the part. Pneumatic drum gives quick and excellent results on contoured shaped parts. Everything we sell is industrial quality. Send for brochure. SAND-RITE. Free. Circle No. 1275.

THE PERFECT SET-UP—Set of six large angles—15°-12 sided cut, 18°-10 sided cut, 22.5°-8 sided cut, 30°-6 sided cut, 45°-4 sided cut, and 60°-3 sided cut, with attaching bar for setting miter and bevel on radial arm saws, bandsaws, drill presses and benchesaws. Also commonly used angle cuts. A precision cut every time. They are more accurate than a bevel gauge, because they are fixed angles. A must for every shop. Send for literature. ROBERT S. SMITH INC. \$1.00. Circle No. 1279.

FREE: HOW TO SAVE TIME AND MATERIAL — Work with confidence and control. SHOPHELPER Safety Guides provide stability, to help eliminate binding, chatter, and kick-back. With an extra pair of hands from SHOPHELPER you can hold work firmly on table and radial saws, shapers, band saws, and others. Complete information from WESTERN COMMERCIAL PRODUCTS. Free. Circle No. 1290.

BITS, BLADES CUTTING TOOLS

AMERICAN GATOR TOOL CORP.—offers this new 20-page catalog covering their broad line of cutting supplies. It includes 3-wheel band-saw blades, professionally welded bands for all makes and models of machines, industrial grade hole saws, hack saws, power hack and sabre saw blades. Also included is a full line of abrasives: sanding belts, fiber discs, sandpaper, cut off wheels and handy rolls. To complete the line they have added circular saw blades, router bits and dowel pins. The catalog also details the firm's quality, competitive prices, quantity discounts, and fast service. AMERICAN GATOR TOOL CORP. 25¢. Circle No. 1305.

OVER 600 ROUTER BITS—are now available. The all-new 1987 Byrom catalog features 1/8"-3/4" shank in high speed steel and carbide tip. Over 20 pages, 80 new items, and over 80 technical drawings. "Industrial Information Kit" includes catalog, industrial price list, name of nearest dealer,

and 2-yr. subscription to special sales and new product introductions. BYROM INTERNATIONAL. \$3.00 (refundable). Circle No. 1308.

CARBIDE TIPPED ROUTER BITS AND SHAPER CUTTERS — Over 200 router bits and shaper cutters displayed in catalog featuring 6 piece cabinet sets, 3 piece 1/2 in. shank router bit panel raising system, and 3 wing industrial shaper cutters. Shaper cutters available in 1/2 in. through 1-1/4 in. bore with bushings. Router bits offered in 1/4 in. and 1/2 in. shank. CASCADE PRECISION TOOL CO. \$1.00. Circle No. 1315.

INDUSTRIAL QUALITY CUTTING TOOLS — DML offers 1,002 different cutting tools, each engineered for a specific task, all made in America. Four information-filled catalogs-detail carbide-tipped saw blades, bits, and cutters: concise copy explains applications, photos show tool configurations, and charts list sizes. DML, INC. \$1.00. Circle No. 1318.

INDUSTRIAL QUALITY CUTTING TOOLS — Three large, colorful wall posters keep DML's huge line of carbide-tipped cutting tools close at hand for easy reference. Separate posters for saw blades, shaper heads (with diagrams of each cut), and router bits. Each features graphic displays of the tools, capabilities, and sizes. DML, INC. \$3.00. Circle No. 1319.

SHAPER CUTTERS—Carbide or tantung tipped—featuring 3/4" bore, innovation in 6 cutter cope and pattern sets. Also, 15° upshear raised panel cutters. Look for the orange or yellow cutters so you can be assured of Freeborn quality. FREEBORN TOOL CO., INC. \$1.00. Circle No. 1320.

CUTTING TOOLS — Freud provides the finest in handtools and carbide cutting tools. From chisels and planes to saw blades and router bits. All this and more. Send for catalog. FREUD. \$1.00. Circle No. 1321.

PRODUCTION QUALITY CARBIDE TIPPED ROUTER BITS — MLCS Ltd. offers a full line of professional production quality carbide tipped router bits at 50-70% lower than retail prices. We sell through the mail and only direct to craftsmen. Send today for information. MLCS LTD. Free. Circle No. 1350.

MERLE ADJUSTABLE CORNER CLAMP — Quick & easy to use. Fully adjustable from 2 1/2" to 36x36 in. Perfect for clamping picture frames, cabinets, or anything that requires 90° corner clamping. The Merle Clamp is cast aluminum & steel construction, a true industrial quality tool. Send today for information. MLCS LTD. Free. Circle No. 1351.

DOOR SHOP® MANUAL AND CATALOG — The 37-page Door Shop® manual is clearly written and beautifully illustrated with over 156 detailed drawings covering the complete process of door building. Each section covers proper methods and exact set-ups for the router, including how to

recognize and correct for errors. There are sections covering design, lumber selection, measuring, panel raising, rail and stile fitting, guides, clamping, gluing, and finishing. This is the most comprehensive manual out today. When you purchase the Door Shop® manual for \$5.00 you also receive Zac's 26-page router bit and shaper cutter catalog free. And as an extra bonus you receive a hardwood door corner sample with your catalog order. \$5.00 rebated with purchase. ZAC PRODUCTS INC. \$5.00. Circle No. 1395.

HARDWARE/WOOD PARTS

MODERN HARDWARE FOR CRAFTSMEN — European concealed hinges for wood and glass doors are our specialty. No-bore glass door hinges plus everything else for your stereo cabinet from casters to lid hinges. Make your kitchen cabinets more functional with wire shelves, baskets, and slides. Build a computer cabinet using our TV extension slides. No minimum order requirements and our prices are low. ALLEN SPECIALTY HARDWARE. \$1.00. Circle No. 1405.

HARDWARE CATALOG—A unique catalog of the very finest in classic, traditional solid brass cabinet hardware. All of British or No. American manufacture. Double & single post handles, knobs, escutcheons, standard & specialty hinges, box hardware, brass screws, castors, latches, catches, locks, and more. GARRETT WADE CO. \$1.00. Circle No. 1427.

BRASS FURNITURE HARDWARE — This 36-page catalog shows over 500 items of authentic reproduction hardware from the 1700's and on into this century. This fine quality hardware is a must for the furniture craftsman working on a new project, or the refinisher who needs replacement hardware. HORTON BRASSES. \$2.00. Circle No. 1430.

SQUARE DRIVE SCREWS—Once you try them, you will never want to use anything else! The square drive recess virtually eliminates work-damaging driver bit "cam-out," the "lo-root" thread design results in superior holding power; and they are heat treated for strength. Sizes from #6 x 1/2" to #12 x 3", with brass plated, solid brass, and zinc plated available. Quantity discounts. Send for literature. McFEELY HARDWOODS. 25¢. Circle No. 1450.

WOODWORKER'S SPECIALTIES — 48-page catalog of plans and hard-to-find hardware for woodworkers. Dozens of wood toy plans & accessories, including wood wheels, fenders & decals. Also wood turnings, brass hardware, canister liners, stencil supplies, & wood cutouts. MEISEL HARDWARE SPECIALTIES. \$1.00. Circle No. 1455.

TOYMAKER'S SUPPLY COMPANY—has your best bulk price on quality wooden toy parts and toy plans. Over 50

NEW
from
Penn State
Industries... a
supplier of quality products
for over 40 years

Professional quality, precision . . .
Super 15" Scroll Saw
Comparable value over \$500
Only **\$139.⁹⁵** shipped complete
ready to run

This versatile machine makes cutting intricate wood patterns easy — great for making toys, jewelry, puzzles, fretwork, etc. The blade is driven on both up and down stroke with a smooth cutting parallel rocker arm system. This avoids blade breakage and creates a smooth finish that virtually eliminates sanding. Our saw is easy to use and is made with a cast construction that insures durability. We fully support our product with replacement parts and repairs if needed. Thousands of satisfied customers use this saw world-wide.



SPECIFICATIONS:

- Cast iron construction
- Throat depth — 15"
- Max depth of cut — 2"
- Cuts per minute — 1725
- Weight — 43 lbs
- Motor — Heavy duty totally enclosed fan cooled 110V - 120V UL listed, ball bearing — induction motor
- Use standard 5" blades
- Stroke length — 3/4"
- Table Tilt — 0 - 45°
- Table Size — 8" x 17"
- Blower Option — \$15.00

30 Day Money Back Guarantee—1 year warranty parts/labor
FREE: 12 Blades & Blade Holder Set with purchase

PENN STATE INDUSTRIES—W

2850 Comly Road • Philadelphia, PA 19154
1-215-676-7609 (Ext.15)

Visa, MasterCard, Check or Money Order Accepted
Add \$10.00 for shipping in Continental U.S. • Pennsylvania residents add 6% sales tax

Be Your Own Boss and Make

\$18.00
to
\$30.00
AN HOUR!



Your FREE Lifetime Security Fact Kit tells you how to make \$18.00 to \$30.00 an hour in your own Foley-Belsaw Full-Service Saw and Tool Sharpening Business. Your FREE Fact Kit explains how you can:

- be your own **BOSS!**
- work full time or part time, right at home.
- do work you enjoy and take pride in.
- operate a **CASH** business where 90¢ of every dollar you take in is clear **CASH** profit.

And it is so easy to learn. Foley-Belsaw gives you all the facts and instructions. No experience or special training is necessary. Foley-Belsaw tells you everything you need to know to be successful.

And there's plenty of business available in your area. You will be able to sharpen all types of saws, garden and shop tools for home, farm and industry.

You will be able to set your own hours and not have to worry about layoffs and strikes. And there are no franchise fees. Any age person can succeed.

But you've got to get the **FACTS** before you can get started. So write **NOW** for your **FREE** Lifetime Security Fact Kit. It's yours to keep with **NO OBLIGATION.**

... send **NOW** for your **FREE** Lifetime Security Fact Kit!



FREE
LIFETIME
SECURITY
FACT KIT



The Foley-Belsaw Co.
20455 Field Bldg.
Kansas City, MO 64111

YES, I want to know more!
Please rush my **FREE** Lifetime Security Fact Kit.

Name _____
Address _____
City _____ State _____ Zip _____
(Area Code) Phone _____

turnings to make your toys professional looking. Send for catalog. TOYMAKER'S SUPPLY CO. Free. Circle No. 1475.

WOOD TOY PATTERNS — Patterns for all ages including children's patterns and executive toys. New catalog has many new patterns to choose from including parts and wheels. Send for new catalog and receive a coupon for free wheels and axle pegs. TOYS AND JOYS. \$1.00. Circle No. 1480.

QUALITY AMERICAN-MADE WOOD TURNINGS — such as shaker pegs, spindles, toy wheels, toy parts, craft items, and dowel rods in birch, oak, walnut, and cherry. Send for complete 32-page catalog. WOODWORKS. \$1.00. Circle No. 1490.

INCOME OPPORTUNITIES

AMITY, NATION'S #1 QUALITY FURNITURE RESTORATION CO. SINCE 1971—New 1987 product catalog featuring: Complete restoration systems - Amity's new paint remover with Purge-All, removes stains, dyes, and silicone - Non-flammable water based stains and finishes - Nationally reknowned Amity 1-2-3 wipe on finishes - Perma-Fuse repair kit repairs and replaces broken and missing parts. Regional workshops in your area. AMITY. \$1.00. Circle No. 1605.

DEVELOP A PROFITABLE SECOND INCOME—in your spare time making small, unique bandsaw boxes. This unpublicized, little-known technique allows you to turn common inexpensive lumber and scraps into valuable utility boxes for the home and office. High demand in gift shops, stationery stores and craft fairs. Fully illustrated instruction booklet of 15 original and profitable designs. Satisfaction guaranteed. BOX-ART. \$10.00. Circle No. 1615.

START SMALL BUSINESS WITH NEW SCROLL SAW — The Excalibur precision scroll saw from Canada can turn your workshop into a profit center. Make toys and puzzles, do intricate marquetry work or detailed cabinet work with these "operator friendly" machines. Hundreds sold in the U.S. already. Save, buy direct, from \$495. up. Complete project patterns and plans available. Send for brochure. J. PHILIP HUMFREY INT. \$1.00. Circle No. 1655.

FURNITURE RESTORATION—Earn \$200-\$1000 per day stripping, repairing, refinishing, mirror resilvering, and/or veneering, at home or in shop, spare time or full time. Complete training. No experience necessary. Attend free furniture restoration seminar. Send for catalog. MINUTEMAN. \$1.00. Circle no. 1661.

BUILDING CONSTRUCTION—Learn how to profit as an independent contractor or save thousands building your own home...with NRI at-home training in Building Construction. 70 lessons, plus over 100 practical hands-on projects cover the full spectrum of construction—from site selection to exterior finishing & landscaping. Send for catalog. NRI SCHOOL OF BLDG. CONSTRUCTION. \$1.00. Circle No. 1665.

MISCELLANEOUS

PERSONALIZED BRANDING IRON — Personalize your finished projects with BrandMark's solid brass branding iron. Easy to use, lasts for years, satisfaction guaranteed. Makes an ideal gift. See ad elsewhere in this issue or send for brochure. BRANDMARK. 25¢. Circle No. 1905.

TOOLS, KITS, & MUCH MORE!—Our buyers travel the world to find manufacturers' closeouts and overstocks. You'll find a tremendous selection of quality merchandise at liquidation prices. Shop at home for tools, air compressors, generators, binoculars, stereos, housewares and appliances. Easy ordering by toll-free phone or mail. Big, full color catalog packed with exciting products. C.O.M.B. Co. \$1.00. Circle No. 1909.

MAKE WOODEN TOYS — Whirligigs, doll houses, swing sets, classic autos, furniture and crafts with our plans, kits, parts, and supplies. For all skill levels. Also parts (toy, craft, game, and furniture) and dimensional lumber in maple, oak, walnut, and cherry along with specialty brass parts, tools, books, organizers and finishes. Send for color catalog subscription. CHERRY TREE TOYS, INC. \$1.00. Circle No. 1918.

MAKE WOODEN CLAMPS — Save 60%. Kits and plans for 8, 10, and 12 in. wooden handscrew clamps. Acme threaded steel rods, components, handles and full-sized plans provided. Kits also available with uncut and precut maple jaws. You decide how much you want to save. Also available are hundreds of plans, kits, parts, and supplies for wooden toys and whirligigs in our beautiful color catalog. CHERRY TREE TOYS, INC. \$1.00. Circle No. 1919.

BUY YOUR SANDING BELTS DIRECT FROM THE MANUFACTURER — Industrial Abrasives is the company that gives you six free belts with every dozen ordered. But, sanding belts are not the only product we have to offer. In our catalog you will find many specialty items not readily available in your hardware store. Price of catalog refunded with first order. INDUSTRIAL ABRASIVES CO. \$1.00. Circle No. 1975.

THE CUSHION CONTOUR SANDER — is a new concept in pneumatic drum sanding. Sanding sleeves are slid over an air bag (inflated with a hand tire pump) on an arbor to mount it between centers on a wood lathe. Drum effectively flats on profiles, curves, and bevels practically eliminating flat

spots and chatter marks. INDUSTRIAL ABRASIVES CO. Free. Circle No. 1976.

FREE LITERATURE — New brochure showing all moisture meters and accessories for moisture meters such as interchangeable electrodes and probes and cables for in-kill moisture monitoring. Complete line of moisture meters include: Pocket-size Mini-Ligno with LED readout 6%-20%, Mini Ligno E 6%-36%, analog or digital display meters 4%-30%, 60% and a digital moisture meter with built-in compensation for different wood temperatures. LIGNOMAT USA, LTD. Free. Circle No. 1999.

WOOD CARVING — You can obtain information on learning woodcarving by sending for our literature. The offer includes sample copy of *The Mallet Magazine* and two lesson sheets on carving. NATIONAL CARVERS MUSEUM. \$1.00. Circle No. 2021.

BANDSAW OWNERS — A new tool is now available so you can make or repair any length bandsaw blade in minutes. Our splicer enables craftsmen to make up any length blade from economical coil blade stock quickly and easily. Three models are currently available to accommodate blade widths from 1/4 to 1 1/2 in. The tool comes complete with detailed instructions and supplies. We also carry OLSON bandsaw stock at reasonable prices. Send for literature. NEW MILFORD SPECIALTIES CO. 50c. Circle No. 2025.

LETTER LAYOUT GUIDES — Brochure containing complete information about a new product of special interest to scroll sawers, carvers, and wood sign makers. A lettering guide to layout large letters and numbers to be cut in wood or other materials. Made from a durable plastic material for years of use. Price of brochure is refundable with first order. SEYCO SALES CO. \$1.00. Circle No. 2057.

TOOLMARK CO. — We offer a complete line of wood lathe accessories including safety shields, duplicator systems, bowl turners, steady rests, and more. Send for brochure. TOOLMARK CO. \$1.00. Circle No. 2073.

IF YOU ARE INTERESTED IN RESTORING ANTIQUES — This 160-page catalog packed with unusual, hard-to-find items is just for you. Included are hundreds of essential items for antique restoration including top quality brass reproduction hardware, oil lamps and accessories, numerous wood component repair parts and kits, caning and basketry supplies, everything needed for wood refinishing, related tools, books, and a complete line of upholstery equipment and supplies. All at wholesale prices. Send for this informa-

tive catalog. VAN DYKE' SUPPLY CO. \$1.00. Circle No. 2077.

WOODWORKING ASSOCIATION OF NORTH AMERICA — First international association for woodworkers. Benefits include our quarterly magazine *International Woodworking*, specials from selected manufacturers, group health and life insurance, access to the woodworking network. WOODWORKING ASSOC. OF NORTH AMERICA. 50c. Circle No. 2092.

CARVING SUPPLIES

WOODCARVING TOOLS — Whittlers and carvers — Warren Tool Co. offers a catalog for you full of whittling and carving hand/power tools, books, stones, wood, and supplies. Since 1927, the finest in woodcarvers tools. WARREN TOOL CO., INC. \$1.00. Circle No. 2185.

CLAMPS

PERFECT EDGE-JOINING EVERYTIME — "Duo-Clamp" holds your boards flat while applying uniform yet firm pressure to squeeze out excess glue. Bowing totally impossible. The need for a surface planer is eliminated; a light belt sander finishes your job. Patent applied for. Easily assembled and unconditionally guaranteed. Made of sturdy maple. Send for information. MARK PRODUCTS. 25c. Circle No. 2255.

CLOCKS

BUILD A BEAUTIFUL HEIRLOOM CLOCK — From easy-to-assemble clock case kits to plans and hard to find parts for the scratch builder, Murray Clock Craft features the famous URGOS movements and only the finest North American black walnut, mahogany, cherry and white oak. Extensive collection of kits, plans, movements, parts and beveled glass available. MURRAY CLOCK CRAFT LTD. \$2.00 (refundable with first order). Circle No. 2350.

TWS MACHINERY

3/4" SPINDLE WOOD SHAPER

20x18 table size, under nut 3/4", 2 speeds, 6500 and 8000 RPM, with 2 h.p. Baldor motor, fwd/rev, accept cutter to 8", 3 inserts, 3/4, 5/8, 6/8

1140 ALLOY SPINDLE

Optional 3 hp \$599

SPECIAL: US \$49900

TABLE SAW

Outstanding performance, 10" cabinet super precision table saw, 3 hp, 1 phase with mag. switch, 70" long extension, motor cover and dust hood included



SPECIAL: \$99500

EDGE SANDER

ES-6108, Belt 6"x108", 3600 FPM, 1 1/2 hp Baldor motor with mag. switch overload, adjustable table and auto belt tracking

SPECIAL: \$99500



BUFFER/SANDER B/S 906

6"x9" pneumatic drum sander, 6"x6" buffer, Baldor 3/4 hp, 115/230 volt



SPECIAL: \$49900

15"x6" PLANER

Cutting depth 3/4" auto feed, 3 knife cutter, 3 hp, 230V, shaving hood and stand incl.

SPECIAL: \$89500



RESAW WOOD CUTTING

RS-20 1/2"-2" blade, cap. 12 1/2"x20" with rip fence and miter gauge, safety brake, 3 hp, 230V, 1 phase.

SPECIAL: \$1895



8' STROKE SANDER

3 h.p. Baldor motor, 1 phase with 1/2 hp table lifting motor

SPECIAL \$2595



CARBIDE TIPPED SHAPER CUTTERS

SPECIAL: Industrial Quality Cabinet Sets



19-921S \$17900

19-922S \$19900

19-940S \$14900

concave stile and rail set

RAISED PANELS 6" 32-987

32-985

32-986

32-984

SPECIAL: \$6995

TWS MACHINERY

All price F.O.B. Seattle, Washington
Send \$3.00 for catalogue.
Refundable with purchase
P.O. Box 5545 Seattle, Washington, 98155

1-800-663-1644
Call toll free USA or Canada

ALL TOOLS CARRY 18 MONTH WARRANTY

Information

WORTH WRITING FOR

TO ENSURE PROMPT HANDLING OF YOUR ORDER FOLLOW THESE INSTRUCTIONS:

- Circle your choice
- Enclose cash, check, money order for cost of booklets plus \$1.00 service charge (no stamps/foreign)
- Send coupon and remittance to address above
- ALLOW 4-6 WEEKS FOR DELIVERY
- Coupon expires June 16, 1988

WOOD SUBSCRIPTION

1. A 1 year WOOD subscription (6 issues) for \$18.00 — a \$3.00 savings off newsstand rate. Allow 6-8 weeks for first issue. Add \$6.00 outside U.S. Be sure to include payment with total below.

FREE LITERATURE

Circle numbers below corresponding to items in this issue. Please include \$1.00 for handling charge

10.	84.	585.	862.	1265.	1475.
15.	85.	808.	955.	1275.	1976.
41.	250.	850.	1090.	1290.	1999.
42.	270.	860.	1125.	1350.	
44.	565.	861.	1225.	1351.	

PRICED LITERATURE

Numbers below refer to items on which there is a charge. Please include proper remittance.

3....\$1.00	120....\$1.00	390....\$1.00	853....\$1.00	1060....\$3.00	1320....\$1.00	1909....\$1.00
4....\$1.00	160....\$1.00	455....\$9.95	855....\$4.00	1080....\$1.00	1321....\$1.00	1918....\$1.00
8....\$2.00	190....\$1.50	461....\$1.00	875....\$1.00	1085....\$3.00	1395....\$5.00	1919....\$1.00
12....50c	215....\$0.50	465....\$1.50	877....\$2.00	1160....\$1.00	1405....\$1.00	1975....\$1.00
33....\$7.95	226....25c	466....\$1.00	880....\$2.00	1190....\$14.00	1427....\$1.00	2021....\$1.00
48....\$1.00	232....\$2.00	485....\$2.00	890....\$1.00	1210....\$1.00	1430....\$2.00	2025....50c
49....\$1.00	310....\$2.00	517....\$1.00	900....\$4.00	1235....25c	1450....25c	2057....\$1.00
51....\$1.00	315....\$1.00	520....\$1.00	915....\$3.00	1245....\$1.00	1480....\$1.00	2073....\$1.00
55....50c	325....50c	525....\$5.00	920....\$1.00	1249....\$1.00	1490....\$1.00	2077....\$1.00
56....50c	332....\$1.00	530....\$2.00	935....\$3.00	1253....\$1.00	1490....\$1.00	2092....50c
63....\$1.00	340....\$1.00	535....\$1.00	945....\$2.50	1279....\$1.00	1605....\$1.00	2185....\$1.00
91....\$1.00	342....\$1.00	545....50c	965....\$1.00	1305....25c	1615....\$10.00	2255....25c
92....\$3.00	343....\$1.00	550....50c	975....\$1.00	1308....\$3.00	1655....\$1.00	2350....\$2.00
93....\$1.00	345....\$2.00	563....50c	1015....\$2.00	1315....\$1.00	1661....\$1.00	
95....2.00	370....\$1.00	810....\$1.00	1030....\$1.00	1318....\$1.00	1665....\$1.00	
97....\$1.00	384....\$9.50	820....\$1.00	1050....\$2.00	1319....\$3.00	1905....25c	

Name (please print) _____
Address _____
City _____
State _____ Zip Code _____

I AM ENCLOSING:

\$_____ for priced items
\$ 1.00 for handling
\$_____ total remittance

DEWALT. Radial Arm Saws

7770-10 10" Contractor's Radial Saw

- 3 HP
- Extra Heavy Duty
- Includes: Leg Stand & Upper & Lower Guard

\$699

Limited Offer
Free Freight
Full Line Dist.
Fact. Auth. Service



7749 2 1/2 hp, 10" Radial Saw	\$599
1712 10" Fold Up Radial Saw	\$356
7790 3 1/2 hp, 12" Contractors Radial Saw	\$899
1703 10" Mitre Saw	\$159

BLACK & DECKER Piranha CARBIDE TOOTH SAW BLADE

Cuts smoother, cuts faster,
than ordinary carbide blades.

73-716 6 1/2" 18 Tooth List	\$12	\$7
73-756 6 1/2" 36 Tooth List	\$27	\$16
73-717 7 1/4" 18 Tooth List	\$12	\$7
73-737 7 1/4" 24 Tooth List	\$15	\$9
73-757 7 1/4" 40 Tooth List	\$27	\$16
73-718 8" 22 Tooth List	\$17	\$10
73-758 8" 40 Tooth List	\$40	\$24
73-719 8 1/4" 22 Tooth List	\$18	\$10
73-759 8 1/4" 40 Tooth List	\$41	\$25
73-739 8 1/2" 30 Tooth List	\$30	\$18
73-769 9" 60 Tooth List	\$64	\$40
73-740 10" 32 Tooth List	\$31	\$19
73-770 10" 60 Tooth List	\$65	\$40

BUY ANY 3 DEDUCT 10 PERCENT



TOOL CRIB OF THE NORTH SINCE 1948

CALL TOLL FREE FOR MIKE
1-800-358-3096



ATTENTION FLORIDA WOODWORKERS

We have Florida's largest and most unbelievable selection of exotic imported and native hard and soft woods, table slabs, veneers, etc. We also stock Ashley Isles carving tools. Send self-addressed stamped envelope for list.

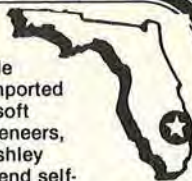

HENEGAN'S WOOD SHED

7760 Southern Boulevard
West Palm Beach, FL 33411
Call (305) 793-1557
Open Tues.-Sat. 9:00-5:30

WOOD TOY

- ★ Patterns
- ★ Parts
- ★ Wheels
- ★ Many New Patterns to Choose from.
- ★ Executive toys



SEND \$1.00 FOR NEW CATALOG & RECEIVE COUPON FOR FREE WHEELS & AXLE PEGS.

toys and joys

Box 628W Lynden, Wash. 98264

Have a problem with your subscription?

We want to solve it to your complete satisfaction, and we want to do it fast. Please write to: Robert Austin, *Better Homes and Gardens*® WOOD, P.O. Box 10628, Des Moines, Iowa 50336.

You can help us by attaching your magazine label here, or copy your name and address as it appears on your label. Send this along with your correspondence.

	Apt. #	State	Zip
Name	Address	City	

Moving?

Simply attach the mailing label from this magazine and write in your new address below. (Please allow 4-8 weeks.)

Your New Address Goes Here

Name _____

Address _____ Apt. # _____

City _____

State _____ Zip _____

Subscription Rate:

6 issues — 1 year — \$18. Add \$6 for Canadian or foreign postage.

- Renewal New Order

For Fast Service...

... it is better to write us concerning your problem and include the magazine label. Also, address changes are handled more efficiently by mail. However, should you need to reach us quickly the following toll-free number is available:

800-247-2504

Better Homes and Gardens®

WOOD

P.O. Box 10628 • Des Moines, Iowa 50336

MADE IN U.S.A. NEW! POWER-FEED

DRUM SANDER

30-DAY FREE TRIAL!

12 in. and 26 in. models

FREE DETAILS

A Finish Sander... A Thickness Sander

You can use this high-tolerance machine for light dimensioning as well as the finest finish work. Because stock is power-fed at a uniform rate, you'll achieve results impossible to duplicate with hand methods or hand-held sanders. Dimensions remain exact... no more low spots, waves or cross grain marks!

Improves Results!

Use the Woodmaster to dimension and finish-sand cabinet pieces, resawn stock, paneling, grandfather clocks, toys, tabletops, knees, burls, crotches, and much, much more! You'll soon find it's one of the most valuable tools in your shop!

30-Day FREE Trial!

Send for Complete Facts! See how you can use the Woodmaster Drum Sander in your own shop for 30 days completely without risk! Easy terms.

Call Toll-Free Today 1(800)538-4200 Ext. 2418

Woodmaster Tools, Dept. RW18, 2908 Oak Kansas City, MO 64108

YES! Please rush my FREE Information Kit and details on your 30-Day Free Trial Guarantee.

Name _____
Address _____
City _____ State _____ Zip _____

Furniture Restoration

Big Money in Small Business

Stripping ★ Repairing ★ Refinishing
Mirror Resilvering ★ Veneering

Earn \$200-\$1000 a day!

At home or in shop ★ Spare time, full time
Men or women ★ Complete training, no experience necessary
★ Simple, fast, safe, fun.

FREE CATALOG

Send \$1.00 for postage & handling to:
MINUTEMAN, INC., Dept. 17,
115 N. Monroe St., Waterloo, WI 53594

WOOD REPAIR

Durham's Rock Hard Water Putty makes lasting repairs in wood. Won't shrink or fall out. Sets quickly, holds tight and can easily be painted. Economical, easy to use. Available at lumber, paint and hardware stores.

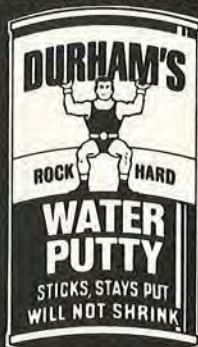

DONALD DURHAM COMPANY

Box 804-W Des Moines, IA 50304

The Discerning Craftsman



Father's Day Gift List

Print this article

Father's Day is June 21. Check the items you want, tear out this section and casually leave it where your family can find it. They'll get the hint!



Industrial quality Forstner bits yield a clean, flat bottom because they're guided by their rim. Heat-treated steel assures lasting performance. Bits range in size from 1/4" to 2 1/8" in 1/8" increments. 16-bit set lists for \$249, now \$199 at your participating Freud dealer. For more information or the dealer nearest you, call FREUD toll-free 1-800-334-4107; in NC 1-919-434-3171; western US 1-800-824-8045.



Cherry Tree Toys' catalog has a new series of plans, parts and kits for wooden whirlygigs like those once used to sit atop fence posts on country lanes. Both toymakers and woodworkers find this catalog a great source for plans, turned parts, kits (for varying skill levels) and supplies. Subscription \$1. CHERRY TREE TOYS, Box 369-309, Belmont, OH 43718.



Solid cast iron frame and big 12" x 12" work table. Extra large 20" throat and 2" depth of cut. Variable speed motor and a drive mechanism submerged in oil bath provide the smoothest possible power transmission. The model 435... built for a lifetime of service yet priced for the home workshop. FOLEY-BELSAW CO., 6301 Equitable Rd., Dept. 42018, Kansas City, MO 64120.



The Byrom 15-piece professional router bit set offers you the most convenient and economical way to purchase 1/4" shank carbide router bits. Hand-crafted wooden tool chest allows you to store up to 80 bits. Suggested list \$327.50; on sale now for Father's Day at participating dealers for \$189.95. For the dealer nearest you, contact BYROM INT'L., Dept. FD-1, 117 South St., Chardon, OH 44024; 216-285-2341.



Powerful ceramic magnetic bar provides safe storage of fine woodworking tools. Even round tools are held securely by the bar, which will support tools as heavy as a 15-lb. sledgehammer. 24" bar is chrome-plated and comes with two adjustable hanger tabs. \$19.95 plus \$1.50 shipping. Call toll free 1-800-338-0527 or write MAGNA-PRODUCTS, 569 N. Main St., Grafton, Ohio 44044.



Constantine brings you a European-made set of four beechwood-handled, bevel-edge chisels. Quality steel blades. Sizes include 3/8", 5/8", 3/4", 1". A useful addition to any tool collection, a handsome gift for any woodworker. #B693 \$14.95. *Special Bonus:* Order today and get a free full-color Constantine's catalog. CONSTANTINE'S, 2054 Eastchester Rd., Bronx, NY 10461.



A gift for a lifetime! The professional Porter-Cable model 690 router. High torque 1 1/2-hp motor. Includes 1/4" and 1/2" collets. Micrometer depth-of-cut control. Man-sized control knobs. Ball-bearing construction. Super sale price \$119.95 ppd. R.A. NESS & CO., THE WOODWORKERS EMPORIUM, 8888 N. Milwaukee Ave., Niles, IL 60648; 312-824-0565.



The Dupli-Carver is a wood duplicating machine that can reproduce three dimensional carvings in wood. The machine uses a stylus (tracer) to follow the contours of a statue or plaque, while a router carves a duplicate. Two models starting at \$299. WOOD-MIZER®, 8180 W. 10th St., Dept. QQ14, Indianapolis, IN 46214; 317-271-1542.



Scroll Saw Handbook by Patrick Spielman covers design, operating basics and cutting techniques; gives comparative info on saws plus dozens of projects. Scroll Saw Pattern Book by Patrick and Patricia Spielman contains over 450 patterns, projects and more. \$12.95 each or BOTH for only \$20. Add \$1.95 s/h. **ADVANCED MACHINERY IMPORTS LTD.**, P.O. Box 312, Dept. 155, New Castle, DE 19720.



Building attractive bird houses and feeders is easy with this wonderful selection of patterns. Each project is fully described with sketches, FULL SIZE patterns and lists of material, so you just can't go wrong. Just \$7, first class. **MASTERCRAFT PLANS WEST**, Dept. 16HW, PO Box 625, Redmond, WA 98073.



Workbench Tool Company is now offering its 11-piece Amana carbide router bit package #AMS-111 for only \$88.75. A great router bit package at 47% off regular price. The perfect Father's Day gift for a woodworker. **WORKBENCH TOOL COMPANY**, 2833 Perry St., Madison, WI 53713.



The Swift is a 21" two-masted schooner. Kit features pre-cut parts and clear instructions. Build a walnut-planked wooden ship model that's lifelike in every detail with solid brass fittings and delicate rigging! FREE tools, cannon kit and handbook with every order. Swift Kit No. AL139TM, only \$29.95. (Add \$3 for delivery.) **MODEL EXPO INC.**, 23 Just Rd., Fairfield, NJ 07007.

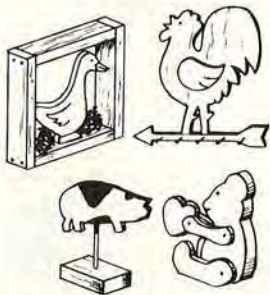

Over 50 folk art patterns! Create profitable "country cut" woodworking designs. This fun-filled packet contains over 50 full-size blueprint patterns PLUS hundreds of unique decorative projects. Enjoy this popular pattern packet plus woodworking brochure for only \$7. **ACCENTS IN PINE**, Dept. CA-57, P.O. Box 262, Danvers, MA 01923.



Master Woodcraft Machine Company's Century XXI multi-function tool will challenge any woodcrafter. Fully accessorized, the Century XXI becomes 11 precision tools, each performing the most demanding woodworking functions. **MASTERCRAFT**, 800 Spruce Lake Dr., P.O. Box 669, Harbor City, CA 90710, or call 1-800-421-2467; in CA 213-549-0761 collect.



3/4" and 1/2" spindle shaper with router bit collet. 1 1/2-hp induction motor. Two inserts in ground cast iron table. 1" vertical spindle travel. All ball bearing; reversing switch; includes stand. Only \$379 F.O.B. **CASCADE PRECISION TOOLS**, P.O. 848, Mercer Island, WA 98040; 1-800-235-0272; in WA 206-236-0272.



Special Value Clamp Set to make the job easier and faster. Includes all the clamps you need for gluing together a drawer, box, frame, door or chair. Two band clamps are 15-foot one-inch nylon and hold up to 1,000 lbs.; also wrench and corner protectors. 13G50 \$66.40 value, \$57.50 ppd. **WOODCRAFT SUPPLY CORP.**, 41 Atlantic Ave., P.O. Box 4000, Dept. WBHF87, Woburn, MA 01888.

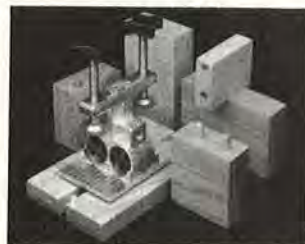

This doweling jig is a significant advance in doweling because it is self-aligning, and automatically matches/aligns mirror-image holes to the second board. Patented design guarantees perfect dowel pin alignment. The Dowel Crafter, model G1662, regularly \$49.95 now only \$39.95 ppd. **GRIZZLY IMPORTS, INC.**, P.O. Box 2069, Bellingham, WA 98227; 206-647-0801.



The perfect gift for Dad: Black & Decker's new Piranha® carbide saw blades. These blades feature technology not previously available. Curved carbide teeth and an advanced grinding process enable these blades to dramatically outperform ordinary carbide blades. Available in seven popular sizes ranging from 16 to 60 carbide teeth. Available at retail stores everywhere.



"Techniques for Wood Toymakers" is especially for the novice toymaker. It features ideas to improve your designs, six special homemade jigs/tools, plus more than 50 illustrations and photos. Only \$1.98 for "wood" fathers. **TIMBERS/LAKE TAHOE, INC.**, Timbers Building, Ste. T15, Carnelian Bay, CA 95711-0850.



Jet's 15" scroll saw is just right for cutting the intricate designs required in making puzzles, toys or jewelry. This UL-list model features a 115V single-phase motor, an 8" x 16 1/2" table with a 45° tilt and 5" blade. Replacement parts and service immediately available. Refer to Jet ad for dealers or write: **JET EQUIPMENT & TOOLS**, P.O. Box 1477, Tacoma, WA 98401.



Give dad the best from England. This genuine Record woodworker's vise features a quick release lever, front dog and accurate machined housing. With a jaw width of 7" and jaw opening of 9", ample clearance is provided for gripping large work. #300-0600 woodworker's vise \$49 from FINE TOOL SHOPS INC., Dept. WM67, 170 West Rd., P.O. Box 7091, Portsmouth, NH 03801.



These dinosaur kits make great gifts for young and old alike. Die-cut of gum plywood, they assemble like a jigsaw puzzle. They are packaged in colorful cartons which describe these prehistoric giants. The spinosaurus (shown) is 20" long. Price is \$8.50 ppd. Buy three (all different) for \$22.50 ppd. ARMOR PRODUCTS, Box 445, East Northport, NY 11731; 516-462-6228.



Executive wood toys! Now you can create this 1929 Ford showpiece and many others like it from our detailed and easy-to-read patterns. We offer you a complete line of patterns, parts and wheels. Make this holiday season a time to remember with one of our executive wood toys! Send \$1 for catalog to: TOYS AND JOYS, Box 628 GL, Lynden, WA 98264.



Solid 1 3/8" hard maple hearts in several thicknesses for craft, decor and art work. 100 hearts 1/4" thick \$14 ppd. Also dowels, pegs, plugs. MIDWEST DOWEL WORKS, 4631 Hutchinson Rd., Cincinnati, OH 45248.



Personalize your wood items quickly and easily with this brass branding iron. First line: HAND CRAFTED BY; second line: your choice of up to 20 characters including spaces. Compact size. \$28 ppd. Guaranteed. Order toll-free 1-800-826-7606 (NE residents call 402-464-0511) or by mail from NOVA TOOL CO., P.O. Box 29341, Dept. BGL, Lincoln, NE 68529. Shipped within 1 week.



Now you can lay out precise letters and numbers for your wood craft projects. Scrollsaws and sign carvers use these specially designed lettering layout guide sets. Quick and easy-to-use—simply trace around the letters—guides are very durable. Several styles and different sizes are available. Brochure \$1. SEYCO SALES, 2107 S. Garland Ave., P.O. Box 472749, Garland, TX 75047.



Cut intricate patterns in wood, plastics, light metals. Add your own 1/4-hp electric motor to an Excalibur II, and start cutting! \$495 U.S. delivered to your door. Includes 72 blades, wrenches and manual. Try it for 30 days and you must be satisfied, or purchase price refunded. In the U.S., call toll-free 1-800-387-9789, in Canada call collect 416-293-8624. J. PHILIP HUMFREY INTERNATIONAL, 3241 Kennedy Road, Unit 7, Scarborough, Ontario, M1V2J9.



Sand like a professional, quickly and beautifully. The B-12 brush head (top) sands mouldings and intricate carvings without losing detail or shape of the part. Model # DD-63 (bottom) gives quick and excellent results on contoured-shaped parts. Both industrial quality. SAND-RITE MANUFACTURING CO., 321 N. Justine St., Chicago, IL 60607; 312-997-2200.



Carving tool kit: Give dad a quality Warren Tool Kit #KBL3-W. Includes a walnut and brass interchangeable handle and three high carbon steel blades honed ready for use. Send \$20.40 ppd. for the kit or \$1 for a catalog and let dad choose from over 500 items; money-back guarantee. WARRENTOOL CO., INC., Rt. 1, Box 14-A, Rhinebeck, NY 12572; UPS/COD call 914-876-7817.



Moisture-related problems such as shrinking, warping, cracking can ruin the most beautiful wooden pieces. Avoid wood moisture problems by checking the wood with a moisture meter! The pocket-size Mini-Ligno moisture meter is for the serious hobbyist and professional woodworker. For more information contact: LIGNOMAT, P.O. Box 30145, Portland, OR 97230; 800-227-2105, 503-257-8957.



Drum sander attachment converts any radial arm saw to a surface thickness sander for finish sanding up to 44" wide; can be attached to standard stand kit. Hardware kit available. Allows precise dimensioning of boards and parallel edge jointing. PERFORMAX PRODUCTS INC., 17065 Judicial Rd., Dept. W5, Lakeville, MN 55044. Call 1-800-334-4910; in MN 1-612-435-6780.



Receive *The Mallet* magazine each month for one year, a membership card for museum admissions, purchasing, exhibiting and publishing benefits PLUS *The Wedge Head* by Kent Bailey. Send your check or money order for \$15 to: NATIONAL CARVERS MUSEUM, 14960 Woodcarver Rd., Monument, CO 80132, or use Visa or MC by calling 303-481-4737. This offer expires Sept. 30, 1987.



Deburr, grind and polish holes, slots, grooves, curved and carved surfaces by hand with this versatile abrasive cord. It's great for hard-to-reach places. Cord is 75' long, 120 grit, 5/64" aluminum oxide. \$9.25 plus \$1.50 s/h. W.S. JENKS & SON, 1933 Montana Ave. NE, Washington, DC 20002; 1-800-638-6405.



A compact, simple-to-operate unit for quick, convenient production of inflatable sanding drum sleeves and belts for belt sanders and grinders. Produce bump-free belts and sleeves superior to those commercially available, at lower cost, when and as you need them. SANDAID introductory kit includes: press, splicing adhesive, splicing tape, operating instructions, plans for jig \$82.95. KUSTER MANUFACTURING, P.O. Box 34, Skillman, NJ 08558; 201-359-4680.

ZAC

Square It™ fulfills the need of woodworkers to square any tool simply, quickly and accurately. Battery-operated, portable; perfect 90° and 45° settings on table and radial arm saws, jointer, drill press, band saw or any stationary machine. Square It™ and 17-page manual \$76.50 ppd. The Door Shop™, carbide-tipped 1/4" router bit set, complete with stile and rail, slot, panel raising bits and 37-page manual \$89.50 ppd. ZAC PRODUCTS, 34 Renwick St., New York, NY 10013; 800-441-0101 or 212-645-9494.

102



This folding trim saw is ideal for the toolbox. 9", 17tpi blade folds into the slotted wooden handle for protection when not in use. Overall open length 21". \$26.15 postpaid. GARRETT WADE CO., 161 6th Ave., New York, NY 10013; 1-800-221-2942.



Give Signcraft for Father's Day. Signcraft puts your woodworking skills to work in a lucrative field—signmaking. Regular features include routing, carving, sandblasting and painting plus many other types of hand-produced signs. Send for free subscription information. SIGNCRAFT MAGAZINE, P.O. Box 06031, Ft. Myers, FL 33906.

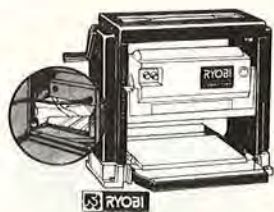

Ryobi AP-10 with free dust chute! Maximum cutting capacity is 10 inches wide, 5 inches thick—16,000 cuts per minute. At 57 pounds, this is the only truly portable planer. The Ap10-C list price is \$689, sale price is \$359. And if you buy one now you'll receive free, a dust chute for the AP-10 that hooks up to your shop vac! This offer is exclusive to TOOL CITY, 14136 E. Firestone Blvd., Santa Fe Springs, CA 90670. Phone 1-800-423-7899, inside California call 1-800-826-7819.



This is a must for that special Dad. The most accurate mat cutter and T-square for cutting perfect mats, both perpendicular and 45° beveled. 30" long rule of light aluminum measures in both inches and centimeters. Only \$22.95 + \$4.00 s/h. CRAFTSMAN WOOD SERVICE CO., 1735 West Cortland Court, Addison, IL 60101.



Emperor's bracket clock is a pleasure to build. Our craftsmen carefully cut each miter, mortise and tenon for a perfect fit. The solid brass movement is completely assembled and warranted for three years. The movement strikes the hour and plays the Westminster chimes. The case is solid 3/4" cherry sanded smooth and ready-to-assemble. For information write EMPEROR CLOCK COMPANY, Emperor Industrial Park, Dept. 2325, Fairhope, AL 36532.

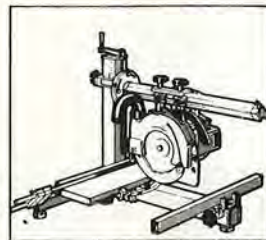

A truly unique tool, Inca's new radial arm saw rolls smoothly and adjusts precisely for all cuts. Four ball-bearing rollers give you amazingly smooth performance. The table turns for accuracy and the entire arm tilts to provide precise compound miters and bevel cuts. The saw pushes into your work rather than pulling for added safety. Cross miter, bevel, rip and groove with this unique machine. Options available: 28" crosscut arm, router carriage and steel stand. HILLER HARDWARE, P.O. Box 1762, Columbia, SC 29202.



Turn your radial arm or table saw into a precision disc sander with Gator Hyde 10" sanding disc. Heavy-duty steel disc mounts easily to saw. Replaceable medium grit disc on one side, fine grit on reverse side. 5/8" mounting bore. Now you can afford the luxury of a disc sander without the cost of an expensive machine. Send check or money order for \$19.95 to: AMERICAN GATOR TOOL CORP., P.O. Box 395, Augusta, MI 49012-0395. Or call 616-731-4177 for a UPS, COD order.

HARDWOODS OF ILLINOIS

Thin hardwood priced right. Clear, kiln-dried, two sides surfaced. 3" to 10" widths, 3' to 6' lengths. 20 sq. ft. packs, random widths and lengths. 1/2" red oak \$36 pkg.; 1/2" walnut \$44 pkg.; 1/2" cherry \$44 pkg.; 1/2" pecan \$29 pkg. 1/4" and 3/8" also available at same price. Prices include UPS delivery. Send check or MO with order. HARDWOODS OF ILLINOIS, RR4, Box 618, Mt. Vernon, IL 62864; 618-244-7221.



The new Delta Universal Wet/Dry Grinder is a dual purpose tool that handles any sharpening job in the home workshop. 10" wet wheel keeps hardened cutting tools cool when grinding to protect temper; 5" dry wheel grinds almost anything that requires a precision-honed edge. Built to deliver long-lasting, smooth performance, the unit is backed by a two-year limited warranty on machine, parts and accessories. DELTA INTERNATIONAL MACHINERY CORP. For additional information call toll-free: 800-438-2486. In PA, 800-438-2487.



Full-size wooden toy patterns—bulldozer, steam shovel and roadgrader \$6.75. Patterns plus hardwood turnings (wheels, axles, etc.) \$14.50. Catalog of patterns, woodworking books and kits. Also carved wood—decoys, fruit, teddy bears and more plus other toymakers' accessories. Catalog free with order. Catalog alone \$1.50. TOY DESIGNS, P.O. Box 441, Dept. BWF-587, Newton, IA 50208.



Simply cut sandpaper from standard sheets for these sleeveless drum sanders. Father's Day special: 1" x 3" and 2 1/2" x 3" set, \$27 + \$2.50 s/h. Many other sizes available. Money-back guarantee. Send check to SINGLEY SPECIALTY CO. INC., P.O. Box 5087B, Greensboro, NC 27403.



"Merle," the adjustable corner clamp, forces your project into square. Fully adjustable from 2 5/8" x 2 5/8" to 36" x 36". Perfect for anything that requires 90 degree corner clamping. Cast aluminum and steel construction; quick and easy to use. \$18.95. MLCS LTD., P.O. Box 53-D, Rydal, PA 19046 or call toll-free 1-800-533-9298. (In PA 1-800-346-7511, ext. 56.) Visa/MC.



This deluxe 14" multi-speed wood lathe comes complete with a cast iron duplicator. Produce identical copies with the confidence of a pro! Heavy, cast iron construction assures stability and eliminates vibration. Built to give a lifetime of service. For complete information call 1-800-654-2254 or write to GREAT PLAINS MACHINERY CO., 4050 Broadway, Dept. 395, Kansas City, MO 64111.



RB Industries proudly produces the Hawk line of precision scroll saws—the largest line of scroll saws available anywhere. Models from 12" to 26" with the newest edition the SS-14, the first true precision scroll saw to fit multipurpose type tools. RBI, P.O. Box 369, Harrisonville, MO 64701; 1-800-535-8665.



Perfect edge-joining every time! Throw away your drill jigs and all other tools! New "Duo-Clamp" solves alignment problems, squeezes out excess glue, eliminates bowing. Made of sturdy maple. 16" capacity \$34.50, 26" capacity \$37.50, 36" capacity \$40.50 + \$3 per clamp for s/h. Free information; phone 216-232-1281. MARK PRODUCTS, P.O. Box 46143, Bedford, OH 44146.



The Skil Twist® cordless power screwdriver is the perfect gift for Father's Day. It's as simple to use as an ordinary screwdriver but twice as fast. And its handy storage/recharging unit keeps it always ready to use. Under \$25 at hardware stores and home centers everywhere.



Like a third hand. Provides that extra support so often needed. Its rugged, heavy-duty, all-steel construction makes it a tool you'll depend on for years. Roller is 13" long, galvanized and ball bearing. Adjusts in height from 25 3/4" to 45". When you're done, it folds flat. #HPR-13 \$39.95 + UPS. HTC PRODUCTS, INC. Toll free 1-800-624-2027; (in Mich.) 313-399-6185.



If you value your fingers you need a RIPSTRATE®. Holds the work tight against the fence with no hands near the blade; makes perfect cuts; wheels lock to prevent kickbacks. No adjustment needed for stock width or thickness. One-year guarantee. \$69 ppd. Check, M.O., Visa or MC. Free brochure. FISHER HILL PRODUCTS, 4 Fisher Hill, Fitzwilliam, NJ 03447; 800-421-0256.



New Delta 10" bench bandsaw. Straight cuts, resawing, curves and bevel cuts on material up to 3" thick by 10" wide. Table tilts 45°R for bevel cutting. Handy blade tensioning control. Single phase 1/2-hp motor. Two-year warranty. Only \$139. ARONSON INDUSTRIAL SUPPLY, 5300 Denver Ave. S., P.O. Box 80987, Seattle, WA 98103. Call toll-free 1-800-243-5250; in WA 206-762-0700.



DML's 10" Radi-All is the best and safest blade for radial arm saws. The specially engineered angle virtually eliminates overfeed and makes extremely smooth cuts through all wood. 5/8" bore, C-4 carbide. #D 1060R only \$59.95. WOODWORKS, 4013-A Clay Ave., Fort Worth, TX 76117; 817-281-4447. Visa/MC accepted.



Buy this superb wooden block plane for about the same price that you pay for a high quality steel plane. Lightweight hornbeam body and super-tough lignum vitae soleplate. Craftsmen use one for fine planing, shaving end grains, etc. Was \$40; Father's Day special \$35 ppd. Catalog \$1 (refunded with first order). HAM-MERMARK ASSOCIATES, Box 201-GL, Floral Park, NY 11002.



Wooden toy and craft plans. Full-size plans with photos and easy instructions. This classic Ford coupe includes spoke wheels, steering wheel and headlights for only \$11.95 ppd. Plans only \$5.50 ppd. Brochure free with your order. Brochure alone \$1. FUNWOOD CRAFTS & TOYS, P.O. Box 541-XK, Coos Bay, OR 97420.



At \$115, the American Classic router from Porter Cable is more than a showpiece. Manufactured with exacting standards that professionals demand, this router has proven itself for over 25 years. Each comes with its own carrying case for easy portability. To order, write THE SOURCE, 7305 Boudinot Dr., Springfield, VA 22150, or call 800-452-9999 (in VA 800-468-1778).



A set of six large angles: 15°, 12-sided cut; 18°, 10-sided cut; 22.5°, 8-sided cut; 30°, 6-sided cut; 45°, 4-sided cut and 60°, 3-sided cut. Also includes attaching bar for setting miter and bevel. Can also be used on boards cut by hand. Angles give a precision cut every time; more accurate than a bevel gauge. \$29.95. ROBERT S. SMITH INC., P.O. Box 17330, Phoenix, AZ 85014.



Kuempel chime clock kits are individually handcrafted by master craftsmen in solid walnut, cherry or oak. Choose tubular bell or rod movements with lyre pendulum and hand-painted moonwheel. Catalog \$2. KUEMPEL CHIME CLOCK WORKS, 21195 Minnetonka Blvd., Excelsior, MN 55331-8605, 612-474-6177.



DML's new "Challenger AD8000" dado adjusts easily and quickly to any width between 1/4" and 3/16"; cuts smoothly, quietly and with less vibration. Twin 8"-diameter, 5/8"-bore 24-tooth carbide-tipped blades are joined at the center by an infinitely adjustable dial. For more information, call 800-233-7297.



Bandsaw owners! A new tool is now available that lets you make or repair any length band saw blade in minutes! Our splicer is available in two models: 1C-001 for 1/2" to 3/4" blades; 1C-002 for 1/8" to 3/8" blades; each \$49.95 ppd. Complete with detailed instructions and 100 splices. NEW MILFORD SPECIALTIES CO., Dept. BHG, 24A South Main St., New Milford, CT 06776; 203-426-4276.



Professionally designed project plans. Cutting boards, table lamps, furniture items and more. Send \$2 for this idea-filled catalog and get \$2 off your first order. THE WORKSHOP BLUEPRINT CO., P.O. Box 65725, West Des Moines, IA 50265.



Freeborn offers the most comprehensive line of 3/4" bore, T-bushed to 1/2", shaper cutters on the market today. These cutters are tipped in carbide or tantung. We also make custom cutters for your special needs. FREEBORN TOOL COMPANY. Call 1-800-523-8988 for the dealer nearest you.



This Delta wet-dry grinder can handle almost every sharpening job. Slow speed 200 grit 10" wet wheel plus smaller 100 grit 5" wheel ideal for high-speed precision grinding. A 1/2-hp motor powers both wheels. Special price \$139.95. WOODWORKER'S SUPPLY OF NEW MEXICO, 5604 Alameda Place N.E., Albuquerque, NM 87113 or call 1-800-645-9292; in NM 1-800-321-9841.



Build this exact duplicate of an original Victorian piano stool from a kit! Smoothly sanded solid maple parts, cast-iron claw feet. Approximately 26 inches high. Some woodworking tools and skills required. Instructions/free catalog with order. \$69.95 ppd. Order #S752. 1-800-843-3320. VAN DYKE'S, Dept. D55, Woonsocket, SD 57385.



Makita 6070DW. This variable speed cordless drill weighs only 2.2 pounds. The built-in power pack recharges in three hours and comes complete with charger. List price \$108. Yours now for only \$58 from BEAVER TOOL & SUPPLY. Call us for all your power tool needs. Free catalog. Call toll-free 1-800-992-2877.



Give Dad a musical project the whole family will enjoy. Build this Gothic harp from a pre-cut kit complete with top-quality hardwoods, decorative trim, hardware, strings and instructions. Fun to build, beautiful to play, excellent for harp teachers, students and performers. Kit price \$399.95, finished value \$1,000. ST. CROIX KITS, 423-B South Main, Stillwater, MN 55082. Catalog #1.



Build a beautiful grandfather clock. From complete easy-to-assemble case kits like the F6SE above to plans and hard-to-find parts for the scratch builder, Murray Clock Craft features the famous URGOS German movements and only the finest North American black walnut, mahogany, cherry and white oak. Extensive selection of kits, plans, movements, parts and beveled glass available. Send \$2 for catalog (refundable with first order) to: MURRAY CLOCK CRAFT LTD., 510 McNicoll Ave., Willowdale, Ont., Canada M2H 2E1.

SUPER 15" SCROLL SAW

Only \$139.95 shipped complete, ready to run. Comparable value over \$500. This versatile machine makes cutting intricate wood patterns easy. Thousands have been used in Europe for many years. PENN STATE INDUSTRIES-W, 2850 Comly Rd., Philadelphia, PA 19154; 215-676-7609, ext. 15.



Edlco is offering a bundle for Father's Day. Ten board feet of 3/8" shorts, 3" and wider, 18"-36" long in cherry, oak or walnut. Bargain priced bundle includes "how-to" project book and top-grade lumber catalog! \$39.95 delivered. Offer good through June 15th only. Specify species; send check or money order to EDUCATIONAL LUMBER COMPANY, Box 5373 W, Asheville, NC 28813.



Radial arm saw owners, now you can have a saw guide that is accurate, affordable and portable. Features stainless steel rule in inches by 1/16" and metric by mm. and cm. Make single and repeat cuts with amazing accuracy for the small shop or the job site. \$84.95 + \$5.05 p/h. AZ-CAL PRODUCTS AND MANUFACTURING, 529 E. Juanita #2, P.O. Box 8429, Mesa, AZ 85204.

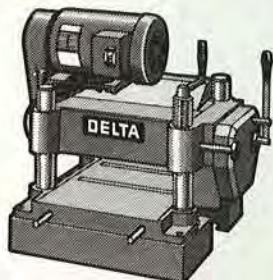

A great gift idea for Dad—the RC-33 Delta 13" planer. Includes table feed roll control, cast-iron construction, 2-hp motor. Now priced at only \$949. Shipped prepaid to your door within continental U.S. Call for Mike 1-800-358-3096. ACME ELECTRIC TOOL CRIB OF THE NORTH.



Wonderland for woodworkers! Illustrations and descriptions of over 180 full-size plans of fine, museum-quality furniture. Includes cradles, roll-top desks, tables, chairs, buffets, chests, gun cabinets, poker table, children's furniture, rocking horse, spinning wheels and more. Send \$2 for catalog (refundable with first plan order) to: 1827 Elmdale Ave., Glenville, IL 60025.



Wooden toy parts and precision woodturning items such as wheels, dowel pins and axles. Also hobby plans for personal gifts and toys. Great for the home woodworker with prices low enough for even large-volume buyers. For information write: THE TOYMAKER SUPPLY CO., 105 Weiler Rd., Arlington Heights, IL 60005 or call toll-free 1-800-624-3938 (in IL 1-800-358-4208).



The Total Shop multipurpose tool. It's a 10" table saw, 34" lathe, 16 1/2" drill press, horizontal boring machine and disc sander—five tools in one quality machine. 1 1/2-hp motor develops nearly 3 hp! Send for our 30-minute video demonstration tape (VHS or Beta). Include \$20 refundable deposit. TOTAL SHOP, Dept. Q1, P.O. Box 16297, Greenville, SC 29606.

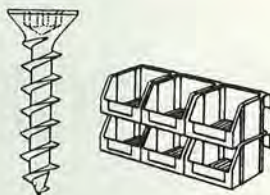

Special square drive assortment includes 100 screws in each of six popular lengths, a hand driver, hex driver for use in a standard drill chuck and a set of six heavy-duty storage bins. #6 assortment: \$16.54; #8 assortment: \$19.47; #10 assortment: \$27.49. MCFEELY HARDWOODS, P.O. Box 3, 43 Cabell St., Lynchburg, VA 24505. Call 1-800-846-2729 (in VA 1-800-542-2023).



This 1" belt sander with 8" disc is an ideal addition to any workshop. The disc and belt sander tables tilt from 0° to 45°. Sand, grind, deburr, sharpen or polish any material. Complete with 1/2-hp motor. \$119.95. Shipped ppd. INDUSTRIAL ABRASIVES CO., P.O. Box 14955, Dept. B, Reading, PA 19612 or call 1-800-428-2222 (continental US), 1-800-422-2292 (PA only).



Is this the world's best joiner-planer? We think so and invite you to take a closer look! MiniMax's new FS-35 joiner-planer combines industrial quality with an affordable price that will appeal to professionals and amateurs alike. THE XYLOPHILES CO., 138 E. Loudon Ave., Lexington, KY 40505; 800-354-9083.

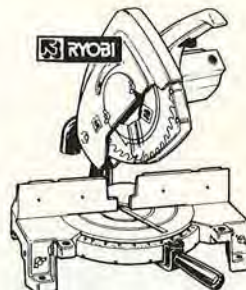

This Ryobi 10" power miter saw cuts up to 45°; slotted metal cutting table turns with the blade for accurate cuts. Positive stops at 90°, 22 1/2° and 45° right or left. Electric brake stops blade in seconds; sawdust ejection system throws sawdust away from operator. \$157. ABBEY TOOLS, 616 North Brookhurst St., Anaheim, CA 92801. Call toll-free 1-800-225-6321; in CA 1-800-252-2221.



WOODWORKING FACTS, FACES AND FABLES

WATCH IT IN THE WOODS! SMOKEY THE BEAR TURNS ENFORCER

If careless woodcutting leads to a fire on federal and state forest lands, you could be in a heap of trouble with Smokey the Bear. Responding to last year's record rash of forest fires — more than in 1981-1984 combined — Smokey plans stern action rather than warnings for fire starters.

Both federal and state forestry officials will seek stiff fines, as well as payment for firefighting costs and even prison sentences, from deliberate offenders. And the careless won't be exempt, either. A Washington hiker already faces payment of \$500,000 in actual costs for an accidental fire he started by burning toilet paper rather than burying it in the Wenatchee National Forest last summer.

TOOLS TELL A TALE

English historian W. L. Goodman speculates that throughout history the number of different tools a woodworker had was determined more by his society's cultural level than the actual chronological date. The higher the level, the more varied the work he was required to do. For example, a joiner in the Rome of the Caesars had a much more

extensive tool set than his counterpart in a small English village of the Middle Ages.

The chart below, from Goodman's *The History of Woodworking Tools*, 1976, David Mckay Co., Inc., NY, shows tools in use during various historical periods. Note that man has always thought it necessary to cut, smooth, and bore wood!

WOODWORKER'S TOOLS THROUGHOUT HISTORY

TOOL	STONE AGE	BRONZE AGE	EARLY IRON AGE	GREEK AND ROMAN	DARK AGES	MIDDLE AGES	1600 TO 1800	1800 TO 1962
Axe	x	x	x	x	x	x	x	x
Adz	x	x	x	x	x	x	x	x
Knife	x	x	x	x	x	x	x	x
Chisel	x	x	x	x	x	x	x	x
Auger	x	x	x	x	x	x	x	x
Hand-saw		x	x	x	x	x	x	x
Cross-cut saw		x	x	x	x	x	x	x
Bow drill		x	x	x	x	x	x	x
Drawknife			x	x	x	x	x	x
Rule				x	x	x	x	x
Plane, smooth				x	x	x	x	x
Plane, jack				x	x	x	x	x
Plane, plough				x	x	x	x	x
Plane, moulding				x	x	x	x	x
T-axe					x	x	x	x
Breast auger					x	x	x	x
Brace						x	x	x
Plane, try						x	x	x
Plane, mitre						x	x	x
Plane, shoulder						x	x	x
Saw, fret						x	x	x
Saw, tenon							x	x
Spokeshave							x	x
Marking gauge							x	x
Breast drill								x
Screwdriver								x
Twist bits								x
All-metal planes								x
Metal brace								x

BAKING A BATCH OF WOOD WASTE

Dr. David Hon, a research chemist at Clemson University, says the U.S. generates about 350 million tons of wood waste a year. And with a Betty Crocker approach, Hon has hit on a way to use much of it.

He liquifies wood so that it molds like plastic. After baking, the end product becomes more durable than either wood or plastic, and it won't burn!

Hon's "wood plasticization" recipe calls for sawdust, chips, or other woody material, and chemicals that act like baking powder.

After compressing the wood to a liquid, he spoons the mixture into a mold, then bakes it.

Although the scientist's baked wood hasn't become commercial yet, similar technology in Japan produces tough knife handles and floor coverings guaranteed for 20 years. At present, Hon's product costs about 25 percent more than oil-derived plastic. But higher oil prices would make his re-formed wood competitive since it comes from a renewable resource — our nation's forests. 🌲

A cigarette doesn't phase Dr. David Hon's plastic-like wood made from waste.





SMOOTHS YOUR PATH EVERY STEP OF THE WAY.

When it's your job to undo in hours both the effects of time and generations of "home improvement," turn to the dependable power of a Ryobi Sander. Whether you choose a compact orbital model or our top-of-the-line belt sander, we help you cut through layers of difficulty with speed and finesse. Excellent balance and perfectly placed handles make your job easier, on a Victorian staircase or a freshly cut sheet of plywood. As for the results: don't be surprised by the sympathetic looks of people who think you did it all by hand. For the first step on the way to a smooth finish, visit your professional power tool dealer for a look at the complete line of Ryobi Sanders.

 **RYOBI**
Built for the real world.™
Bensenville, IL 60106
312-766-1621



TREES HAVE NIGHTMARES ABOUT THIS BLADE.

It's ferociously efficient.
Flawlessly engineered.

IT'S THE PIRANHA® CARBIDE-TOOTH SAW BLADE. FROM BLACK & DECKER.

The Piranha® carbide saw blade lasts up to fifty times longer than conventional steel blades. And outperforms both conventional carbide and steel blades alike.

CUTS FASTER, SMOOTHER THAN CONVENTIONAL CARBIDE BLADES.

Carbide-tipped blades last longer than steel blades. But they tend to cut slower. Rougher. They're harder on the saw, and require more work of the operator.

To solve this problem, Black & Decker has engineered three major breakthroughs in carbide blade technology.

CURVED CARBIDE TOOTH "SLICES" THROUGH WOOD.

Most conventional carbide blades feature a somewhat clumsy block-shaped tooth (see diagram) which "chops" through wood, resulting in a slow, difficult cut.

The Piranha carbide tooth saw blade features an exclusive "curved carbide tooth," which literally slices through wood. Resulting in a faster, smoother cut than conventional carbide blades every time.

Also, by sharpening the tooth through an advanced process,

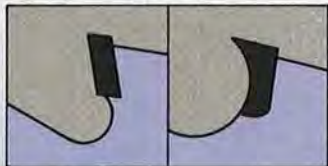

ORDINARY
"BLOCK-SHAPED"
CARBIDE TOOTH

PIRANHA® CURVED
CARBIDE
TOOTH

Black & Decker has achieved an edge considerably sharper than that of conventional carbide blades.

The Piranha carbide tooth blade is even resharpenable, for extended life.

EXTREMELY FAST CHIP REMOVAL.

Another reason for the Piranha blade's ravenous appetite is its exclusive "fishhook gullet" design—a continuous curved surface with no break between the carbide tip and the steel body.

This continuous curved surface prevents wood from wedging beneath the carbide tip, reduces drag, and assures faster more efficient chip removal than conventional carbide blades.

THE RESULT:

A CARBIDE-TIPPED FEEDING FRENZY.

Piranha carbide tooth saw blades are available now in a wide range of sizes, from 5½" to 10", 16 to 60 teeth, for all brands of circular, table, miter, and radial-arm saws. It's no wonder more and more professional job sites across the country are making PIRANHA the carbide blade of choice.

For detailed technical information, write, Black & Decker, 10 North Park Drive, P.O. Box 210-798, Hunt Valley, MD 21030.

The Piranha carbide tooth saw blade from Black & Decker. It may give trees nightmares. But to professional craftsmen, it's a dream come true.



BLACK & DECKER

Piranha
Carbide Tooth Saw Blade

