

Better Homes and Gardens®

WOOD

THE MAGAZINE FOR HOME WOODWORKERS

\$3.50

FEBRUARY 1987 • ISSUE NO. 15
Display until February 17

BAND SAWS

6-page buying guide
plus 7 shop-tested
band saw techniques

AIR-DRY
GREEN WOOD
and stack up
big savings

CRAFTS FAIRS
Sell your work the
fast, fun way

PROJECT PACKED

Country quilt rack
Kitchen canisters
Spice rack
Paper towel holder
'Big Apple' bank
Router straightedge
Block puzzle
Salt & pepper shakers

CRAFT A COUNTRY CLASSIC

See pages 68-82



FORSTNER BITS

from

freud[®]

**One at a time...
Or buy the box!**



The bits available in the Freud 16 Piece Forstner Bit set are now available individually. These individual bits range in size from 1/4" to 2 1/8" in 1/8" increments. A special heat treated steel is used in their production to assure long lasting edges.

The shanks are 3/8" in diameter on all but the 1/4" bit. That shank is 1/4" in diameter. These Forstner bits can be used with either a drill press or a portable drill.

You will find these Freud bits will produce a cleaner hole and offer more accuracy and versatility than other woodworking bits.

Stock No.	Description	List Price	Sale Price
FB-001	1/4" Forstner Bit	7.50	6.39
FB-002	3/8" Forstner Bit	7.50	6.39
FB-003	1/2" Forstner Bit	8.20	6.99
FB-004	5/8" Forstner Bit	9.80	8.34
FB-005	3/4" Forstner Bit	11.50	9.79
FB-006	7/8" Forstner Bit	11.90	10.14
FB-007	1" Forstner Bit	13.90	11.79
FB-008	1 1/8" Forstner Bit	15.40	13.09
FB-009	1 1/4" Forstner Bit	16.10	13.69
FB-010	1 3/8" Forstner Bit	19.90	16.89
FB-011	1 1/2" Forstner Bit	23.90	20.29
FB-012	1 5/8" Forstner Bit	24.70	20.99
FB-013	1 3/4" Forstner Bit	26.70	22.69
FB-014	1 7/8" Forstner Bit	28.90	24.54
FB-015	2" Forstner Bit	30.80	26.19
FB-016	2 1/8" Forstner Bit	34.80	29.59
FB-100	Complete Set and Box	249.00	199.00

Call Us Toll Free!

FOR THE NAME OF YOUR LOCAL DISTRIBUTOR:

- In California
Call Toll Free:
1-800-824-0141
- If You Live
In This Area:
1-800-824-8045
- If You Live
In This Area
Call Toll Free
(Outside NC)
1-800-334-4107

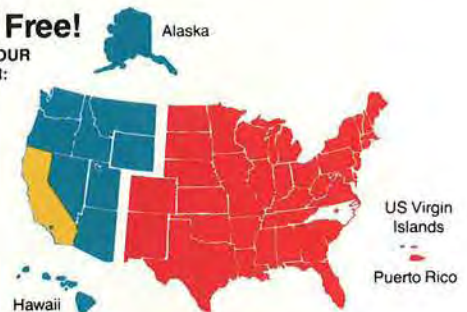

freud[®]

218 Feld Ave.
High Point, NC 27264
(919) 434-3171

1570 Corporate Dr., Suite G
Costa Mesa, Cal. 92626
(714) 751-8866

Offer Expires April 31, 1987

MADONNA TRUE BLUE	4 3 8 1 1	[SIRE]
THE JUDDS: ROCKIN' WITH THE RHYTHM	5 4 2 8 5	[RCA]
BILL COSBY ...You'll Understand	2 4 7 4 7	[OFFER]
*DARYL HALL: 3 Hearts In The Happy Ending Machine	2 3 6 9 1	[RCA]
.38 Special Strength In Numbers	5 4 3 1 1	[A&M]
*GEORGE STRAIT #7	3 4 3 1 9	[RCA]
*BILLY IDOL REBEL YELL	2 4 6 7 4	[CHRYSALIS]
*JEFFREY OSBORNE EMOTIONAL	3 4 3 0 0	[A&M]
JOHN LENNON Live In New York City	4 4 4 9 7	[CAPITOL]
*THE MONKEES Then & Now/Best Of	5 3 1 8 3	[ARISTA]
*DIRE STRAITS BROTHERS IN ARMS	1 4 7 3 4	[WARNER BROS.]

HUEY LEWIS FORE	5 4 5 7 0	[CHRYSALIS]
GLENN MILLER ORCH. In The Digital Mood	4 3 2 9 3	[SPD DIGITAL]
*WHITNEY HOUSTON	5 4 3 8 1	[ARISTA]
HANK WILLIAMS, JR. MONTANA CAFE	6 1 2 3 6	[WARNER BROS.]
VAN HALEN 5150	7 0 2 2 0	[WARNER BROS.]
*DAVID LEE ROTH Eat 'Em And Smile	5 3 8 1 4	[RCA]
*OAK RIDGE BOYS SEASONS	5 4 3 1 2	[MCA]
*PATTI LABELLE WINNER IN YOU	5 4 3 2 7	[MCA]
U2 The Unforgettable Fire	5 4 5 1 5	[ISLAND]
*METALLICA Master Of Puppets	3 4 5 5 2	[ELEKTRA]
*EL DEBARGE 14 6 9 9	1 4 6 9 9	[GORDY]

LIONEL RICHE Dancing On The Ceiling	3 4 5 4 1	[MCA]
ALABAMA GREATEST HITS	2 0 2 4 7	[RCA]
GENESIS Invisible Touch	5 3 7 4 0	[ATLANTIC]
PRINCE PARADE	4 0 2 3 4	[WARNER BROS.]
KENNY ROGERS 20 Greatest Hits	4 4 5 2 3	[MERCURY]
*JAMES GALWAY'S Christmas Carol	5 3 8 2 1	[RCA]
BILLY OCEAN Love Zone	5 3 6 7 9	[JIVE]
AC/DC Who Made Who	2 0 7 7 4	[ATLANTIC]
RANDY TRAVIS Storms Of Life	7 4 0 4 6	[WARNER BROS.]
*POINTER SISTERS HOT TOGETHER	5 3 6 9 4	[RCA]
ZZ TOP AFTERBURNER	6 4 0 4 2	[WARNER BROS.]
EURYTHMICS Revenge	1 0 7 7 0	[RCA]
*SIMPLY RED Picture Book	5 3 9 3 6	[ELEKTRA]
DOLLY PARTON GREATEST HITS	1 4 0 9 0	[RCA]
PHIL COLLINS NO JACKET REQUIRED	2 0 7 7 1	[ATLANTIC]

WOW! **6** **PLUS 2 EXTRA FREE ALBUMS**
For Joining Now!

TOP-STAR TAPES OR RECORDS
FOR THE PRICE OF ONE

...WITH NOTHING MORE TO BUY EVER!

More Smash Hits!

- Hall & Oates: Live At The Apollo 40625
- Dokken: Under Lock & Key 43880
- The Sound Of Music/Soundtrack 00046
- Tchaikovsky Sym. #6/Levine 53939
- Forester Sisters: Perfume, Ribbons 53719
- Jackson Browne: Lives In The Balance 44295
- Robert Palmer: Riptide 33507*
- Air Supply 44555
- Bryan Adams: Reckless 51540
- John Denver: One World 63499
- Chicago 17 20763
- Peter Cetera: Solitude/Solitaire 63723*
- Anne Murray: Something To Talk About 61989
- Tomita: The Planets (Holst) 34256*
- Mr. Mister: Welcome To The Real World 43765*
- Simple Minds: Once Upon A Time 42320*
- Madonna: Like A Virgin 61153
- The Cars: Greatest Hits 53702
- Hank Williams, Jr.: Gt. Hits 2 83683
- Sting: Dream Of Blue Turquoise 50266
- Julian Lennon: Secret Daydreaming 14803
- Miami Vice/TV Soundtrack 44158
- Starship: Knee Deep In Hoopla 63659
- Willie Nelson: Collector's Series 24502
- Bob Seger: Night Moves 43584
- Led Zeppelin IV 12014
- Pachelbel Canon/Pallard 33877
- Grusin/Ritenour: Harlequin 54203*
- Ronnie Milsap: Lost In '50s 50310
- Sam Cooke: Live 1963 64140*
- Chaka Khan: Destiny 54251*
- Hooked On Classics 24392
- Linda Ronstadt: Lush Life 33200
- Sawyer Brown: Shakin' 04807
- Prince: Around The World 24370
- Barry Manilow: 20 GH 14805
- Pointer Sisters: Contact 24611
- Great Love Songs of 50s & 60s 20768
- Galway & Mancini: In The Pink 51758
- Jimi Hendrix: Kiss The Sky 61349*
- Lionel Richie: Can't Slow Down 10767

GTR	1 4 7 8 9	[ARISTA]
*ALABAMA Christmas	3 4 5 9 4	[RCA]
Plácido Domingo & Vienna Boys Choir	4 0 2 0 3	[RCA]
HEART	4 4 2 7 6	[CAPITOL]
KENNY ROGERS The Heart Of The Matter	5 3 9 9 5	[RCA]
*JANET JACKSON CONTROL	3 4 5 2 6	[A&M]
BEST OF THE BEACH BOYS	2 3 9 4 6	[CAPITOL]
TWIN SETS	Double the music Count as one!	

Come Dancing With THE KINKS (19 Hits)	6 0 0 7 7	[ARISTA]
ELVIS PRESLEY From Elvis With Love	3 4 3 4 0	[RCA]
PRINCE 1999	5 2 4 8 3	[WARNER BROS.]
ELTON JOHN GREATEST HITS, Vols. 1 & 2	3 1 7 1 1	[RCA]
28 SIXTIES SOUL CLASSICS	5 0 3 7 5	[ATLANTIC]

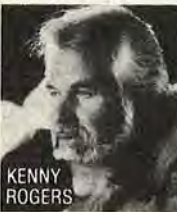

2 FREE BONUS!
Start with **6** tapes or records for only **1¢**
plus shipping and handling with Club membership.
Buy just **1** smash hit in one year's time.
Then get **1** bonus album of your choice.
Enjoy **6** albums for the price of one.
Nothing more to buy...EVER!

START SAVING NOW!

Start Now with 6 Hit Albums for 1¢! Yes, pick any 4 tapes or records for only 1¢, plus choose 2 more as a bonus for acting now. You agree to buy only 1 more hit at regular Club prices (usually \$8.98 to \$9.98)...and take up to one full year to do it. Then you can choose another album free as a bonus. That's 8 smash hits for the price of one and there's *nothing more to buy...ever!*

No Further Obligation Whatsoever! It's all up to you! You buy what you want...when you want to. This is one music offer that really is different. And you pocket the savings!

Exciting "Members-Only" Benefits. Approximately every four weeks, you'll receive MEDLEY, the Club's exclusive music magazine featuring the Main Selection in your favorite music category, plus hundreds of other hits. You will also receive six special sale issues crammed with hit tapes and records—some as low as \$4.98, \$3.98 and even \$2.98. In all, you'll have 19 convenient shop-at-home opportunities a year. As a member in good standing, send no money when you order, we'll bill you later. A shipping and handling charge is added to each shipment.

It's Easy to Get Your Favorite Hits! If you want the Main Selection do nothing. It will be sent to you automatically. If you want other selections, or none, just indicate your preference on the card always provided...and mail it back to us by the date specified. You'll always have at least 10 days to decide. But if you don't, you may return your Main Selection at our expense for full credit. You may cancel your membership whenever you wish upon completing your enrollment agreement. Or, remain a member and take advantage of future money-saving bargains.

FREE 10-Day No-Risk Offer! Listen to your 6 introductory hits for a full 10 days. If not satisfied, return them with no further obligation. You risk *nothing!* So don't delay. Pick your hits, write their numbers on the coupon, and mail today!

1 TAPE PENNY HERE

2 SEND MY SELECTIONS ON (check one only): CASSETTES RECORDS 8-TRACK TAPES*

3 I am most interested in the following type of music—but I am always free to choose from every category (check one only)

1 EASY LISTENING Barry Manilow, John Denver, Kenny Rogers, Beach Boys
2 COUNTRY Alabama, Oak Ridge Boys, The Judds, Ronnie Milsap
3 HARD ROCK ZZ Top, Van Halen, Bryan Adams, Dire Straits
4 POP/SOFT ROCK Lionel Richie, Phil Collins, Prince, Hall & Oates
5 CLASSICAL James Galway, Luciano Pavarotti, Neville Marriner

4 RUSH ME THESE 4 SELECTIONS (indicate by number)

5 PLUS THESE 2 BONUS HITS →

6 Mr. Mrs. Miss First Name Initial Last Name (PLEASE PRINT)
Address _____ Apt. _____
City _____ State _____ Zip _____
Telephone (_____) _____ *Selections marked (*) not available on 8-track.
Area Code _____

7 Have you bought anything else by mail in last 6 months year never

UGS AH

RCA MUSIC SERVICE reserves the right to request additional information or reject any application. Limited to new members: continental U.S.A. only; one membership per family. Local taxes, if any, will be added.

**NOW!
REDUCE THE
RISK AT YOUR
TABLE SAW**



folds down neatly

WITH THE **MOBILE™
NEW SAWING CENTER**

OUTFEED ROLLERS

- safe, accurate sawing
- available in 15" and 37" widths
- handle panels with ease
- dual-position table

AND INCREASE FLOOR SPACE



MOBILE MACHINE BASES

- increase shop working area
- maximize usable floor space
- 3 point base will not rock
- locking wheels
- makes machine so easy to use and store
- over 80 standard models

PLANER STAND WITH ROLLERS

- raises planer to proper working height
- provides machine mobility
- five-fold increase in workpiece support
- storage is a snap



NEW



**ROLLERTABLE
Rock Solid Support**

- adjustable
- portable
- use at any machine

PEDESTAL
ROLLER

Discover HTC's many unique products designed only with you, the dedicated woodworker in mind. Find out how you can make your machining safer, increase working area of your shop and accomplish nearly impossible tasks easily, quickly and accurately - **all by yourself!**

CALL TODAY!

HTC PRODUCTS, INC.
120 E. HUDSON S-8
ROYAL OAK, MI 48067
(313) 399-6185



1-800-624-2027 ext. 112

Better Homes and Gardens®

WOOD

Wood grain in cover logo type this issue is beech

FEBRUARY 1987

ISSUE NO. 15

WOOD PROFILE

YELLOW POPLAR: WILLING TO WORK, PLEASANT TO PAINT, AND YOU CAN'T BEAT THE PRICE

35

Turned, carved, molded, painted — this wood can be found in everything from caskets to pianos.



CRAFTSMAN CLOSE-UP

RUSTIC REDWOOD SIGNS

36

Ever try routing a sign free-hand? Come on, give it a try — it's not that hard. Dave Jordan shares secrets gleaned from 11 years of sign cutting. We've also included a first-time project to start you out.



SHOP-TESTED TECHNIQUES

CUTTING CURVES — AND MUCH MORE

40

Curves, yes — but did you know that cutting circles, arcs, chamfers, and duplicates can be done just as easily on the band saw? Our 7 shop-tested techniques show you how to do them.



WE KNOW YOU CAN BUILD THE BLOCK...NOW, CAN YOU SOLVE THE PUZZLE?

46

Challenge your friends to see how fast they can piece this band-sawn block puzzle back together again.



THE 'BIG APPLE' BANK

48

Colorful and inviting — here's a bank that youngsters will shine up to in a hurry. This easy-to-make project not only encourages thrift, it serves as a cheery-looking child's room accessory. Bet you don't build just one!

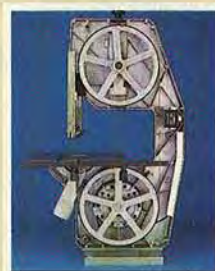

TOOL BUYMANSHIP

BAND SAWS: THERE'S ONE OUT THERE FOR YOU

50

If there's a band saw on your wish list, you'll want to know about throat capacity, cutting height, blade guards, and other important features. Our tool experts talk about these and more.

**ROUTER STRAIGHTEDGE:
IT MAKES DADOES AND
EDGE-JOINTING A SNAP**

56

Simple to make, easy to use, and best of all, it takes up hardly any room in the shop. So don't try routing another blind dado without it.



**MAKE 'EM IN A DASH
SHAKERS**

60

Spice up someone's table setting with these palm-sized mahogany and walnut shakers. The special tenon technique makes it easy to turn them on a lathe.



**WANT TO SELL YOUR WORK?
FOR FUN AND PROFIT,
TRY A CRAFTS FAIR**

62

Hot, booming, the rage — all describe crafts fairs. One, or several, may be the perfect place to sell your ware. And, here's help to get started!



AIR-DRYING GREEN WOOD

64

Many woodworkers take great pride in building with wood they've seasoned themselves. So can you — and save 50 percent or more, for your efforts. Here's where you can find out more about it.

CRAFT A COUNTRY CLASSIC

QUILT RACK

68

Show off a treasured piece of handiwork or valued heirloom on this attractive oak quilt rack.



**KITCHEN CANISTER
& BRASS SCOOP**

72

Make one, or half-a-dozen — we show you how, step-by-step.



SPICE CABINET

76

Charming oak, porcelain knobs, and antique glass — a winning combination.



**PAPER TOWEL
HOLDER**

80

Its country charm will earn this holder a place on many a kitchen wall.



SHORT-SUBJECT FEATURES

Talking Back	8	Wood words	91
Tips from Your Shop	12	Customer Service	97
Wood Anecdote	23	Dividing a Board	98
Products that Perform	24	3 Ways to Sell Your Work ...	104
Project Showcase	58	Bulletin Board	110

WOODWORKS

SHAKER PEGS		MUO PEG		Qty.	Total
3 1/2" Maple Shaker Pegs	\$20.00/100				
2 1/2" Medium Shaker Peg	15.00/100				
1-3/4" Mini Shaker Pegs	7.00/100				
3-3/8" Kitchen Mug Pegs	20.00/100				
2-7/16" Tie Rack Pegs	7.00/100				
Bean Pot Candle Cup	17.00/100				

LOW PRICES

Maple Toy Wheels with 1/4 holes		
1 x 3/8 Maple Toy Wheels	\$6.50/100	
1-1/4 x 7/16	8.50/100	
1-1/2 x 1/2	10.00/100	
1-3/4 x 9/16	14.00/100	
2 x 5/8	17.50/100	
Axle Pegs For Above	4.50/100	

TOY PARTS ASSORTMENT	
25 Items - 519 Parts	39.95/Each

HIGH QUALITY

3/4" Full Round Balls	\$8.00/100	
1" Full Round Balls	10.00/100	
Nutcracker - White Birch	3.00/Each	
Apples	1.50/Each	
Large Egg 1-7/8" x 2-1/2"	35.00/100	
Small Eggs 1-3/8" x 2"	25.00/100	

FAST SERVICE

3/8" Maple Buttons	\$2.15/100	
1/2" Maple Buttons	2.25/100	
3/8" x 2" Dowel Pins	2.20/100	
1-1/2" Maple Spindles	9.00/100	
1-1/2" Oak Spindles	12.00/100	
2-1/8" Maple Spindle	14.00/100	
2-1/8" Oak Spindle	18.00/100	

LARGE SELECTION

1/4" x 36" Birch Dowels	\$4.25/25	
3/8" x 36" Birch Dowels	6.50/25	
1/2" x 36" Birch Dowels	10.50/25	

QTY. PRICES AVAILABLE

9" x 11" ALUMINUM OXIDE-SANDPAPER	
220 Grit	\$18.00/100
180 Grit	16.00/100
150 Grit	16.00/100
120 Grit	16.00/100
100 Grit	16.00/100

BONUS OFFER

CHECK THIS BOX, AND AS A BONUS WITH ANY ORDER FOR WOOD PARTS, WE WILL SEND YOU A COMPLIMENTARY 8 OZ. BOTTLE OF FRANKLIN TITEBOND WOOD GLUE.

\$2.25 VALUE #B1 CHECK HERE



ORDER NOW

TOTAL FOR GOODS	
TEXANS ONLY ADD 5% SALES TAX HANDLING AND INSURANCE	\$3.00
FINAL TOTAL	

MC OR VISA CHECK ENCLOSED

ACCOUNT # _____

EXPIRES _____ PHONE _____

NAME _____

SHIP TO _____

CITY/STATE/ZIP _____

817/281-4447

WOODWORKS

4013-A CLAY AVE. • FT. WORTH, TX 76117

NEW
from
Penn State
Industries... a
supplier of quality products
for over 40 years

Professional quality, precision . . . Super 15" Scroll Saw

Comparable value over \$500

Only **\$139.⁹⁵** shipped complete
ready to run

This versatile machine makes cutting intricate wood patterns easy — great for making toys, jewelry, puzzles, fretwork, etc. The blade is driven on both up and down stroke with a smooth cutting parallel rocker arm system. This avoids blade breakage and creates a smooth finish that virtually eliminates sanding. Our saw is easy to use and is made with a cast construction that insures durability. We fully support our product with replacement parts and repairs if needed. Thousands of satisfied customers use this saw world-wide.

SPECIFICATIONS:

- Cast iron construction
- Throat depth — 15"
- Max depth of cut — 2"
- Cuts per minute — 1725
- Weight — 43 lbs
- Motor — Heavy duty totally enclosed fan cooled 110V - 120V UL listed, ball bearing — Induction motor
- Use standard 5" blades
- Stroke length — 3/4"
- Table Tilt — 0 - 45°
- Table Size — 8" x 17"



30 Day Money Back Guarantee—1 year warranty parts/labor
FREE: 12 Blades & Blade Holder with purchase

To order: Call or Write:

PENN STATE INDUSTRIES
2850 Comly Road • Philadelphia, PA 19154
1-215-676-7609 (Ext. 15)

Visa, Master Card, Check or Money Order Accepted Add \$10.00 for shipping • Pennsylvania residents add 6% sales tax

SUNHILL

SP-101 Cabinet Shop Shaper

* The most popular model in our complete line of shapers!

- Single phase 2 HP motor
- Precision 1" spindle
- 2 5/8" spindle travel
- 2 reversible speeds
- Options include 3 phase 3 HP motor, 1/2", 3/4" and 1 1/4" spindles; Collets for router bits

List - \$1650

SALE - \$1075



TS-10 10" Tilting Arbor Table Saw

- Single or 3 phase 3 HP motor, magnetic switch
- Triple V-belt drive
- 5/8" precision arbor
- T-slot table with mitre gauge
- Milled fence with micro-adjust
- Wt: 485 lbs.
- Sliding table available

List - \$1850

SALE - \$1260



SUNHILL

Dept. F
1000 Andover Park E.
Seattle, WA 98188
(206) 575-4131

© The Iron Shop 1985

NOW! The Affordable OAK spiral.

ONLY
\$1425 F.O.B.
Broomall, PA
For 4' diam. (hts. 8' to 8'8 1/2')

Comparable savings on 5' diam. and other floor-to-floor heights.



Our Oak Spiral Stair Kit is superbly crafted from choice, selected oak and ingeniously designed for easy do-it-yourself assembly. And best of all, it's priced well below any comparable stair on the market!

CALL OR WRITE FOR FREE COLOR BROCHURE:
THE IRON SHOP (215) 544-7100
Dept. 0W27, P.O. Box 128, 400 Reed Rd.
Broomall, PA 19008

MasterCard, VISA and AMEX

Other Showroom & Warehouse Locations in:
Pomona, CA (714) 598-5766
Houston, TX (713) 789-0648
Sarasota, FL (813) 923-1479
Chicago, IL (312) 952-9010

THE IRON SHOP
MANUFACTURERS

Better Homes and Gardens® WOOD

THE MAGAZINE FOR HOME WOODWORKERS

February 1987 • Vol. 4, No. 1 • Issue No. 15

Editorial/Art Staff

Editor **LARRY CLAYTON**
Managing Editor **CHARLES E. SOMMERS**
Art Director **C. L. GATZKE**
Design Editor **JAMES R. DOWNING**
Features Editor **PETER J. STEPHANO**
How-To Editor **MARLEN KEMMET**
Buymanship/Techniques Editor **JIM BARRETT**
Project Builder **JAMES E. BOELLING**
Graphic Designer **PERRY A. McFARLIN**
Administrative Assistant **DARLENE REYNOLDS**
Business Office Clerk **REBECCA REMPE**

Technical Consultants: **GEORGE GRANSETH** Product Testing; **VERNON U. WARD** Collectible Tools; **PAUL L. McCLURE** Wood Technology

Publisher **JERRY KAPLAN**
New York Advertising Manager **MARK S. HART**
Promotion/Research Director **THOMAS R. TROLAND**
Circulation Director **WILLIAM HUMMEL**
Production Director **DALE SCHENKELBERG**
Editorial Research Director **C. RAY DEATON**

Magazine Group Officers

Group President **JAMES A. AUTRY**
Group Vice Presidents
Publishing Director **ADOLPH AUERBACHER**
Editorial Director **DORIS M. EBY**
Operations **CHRISTOPHER M. LEHMAN**

Corporate Officers

Chairman of the Board **E. T. MEREDITH III**
President **ROBERT A. BURNETT**
Executive Vice President—Corporate Services
JACK D. REHM
Group Presidents: Magazine **JAMES A. AUTRY**; Broadcasting **W. C. McREYNOLDS**; Real Estate **ALLEN L. SABBAG**; Book **FRED STINES**
Vice Presidents: Corporate Relations **DONALD L. ARNOLD**; General Counsel and Assistant Secretary **THOMAS G. FISHER**; Product Development **NEIL KUEHN**; Corporate Planning **HERB SCHULTE**; Finance **WILLIAM H. STRAW**; Administrative Services **GERALD D. THORNTON**
Secretary **BETTY CAMPBELL MADDEN**
Treasurer **MICHAEL A. SELL**
Controller **LARRY D. HARTSOOK**

Better Homes and Gardens® WOOD — the magazine for home woodworkers (ISSN-0743-894X) is published bimonthly in February, April, June, August, October, and December by Meredith Corporation, 1716 Locust Street, Des Moines, IA 50336. Second-class postage paid at Des Moines, Iowa. Trademark registered in Canada and Australia. Marca Registrada en Mexico. **SUBSCRIPTION PRICES:** One year \$18 in the United States and its possessions. Canada and other countries add \$6 per year. **POSTMASTER:** Send address changes to WOOD, 1716 Locust Street, Des Moines, IA 50336. February 1987, Vol. 4, No. 1, Issue No. 15. **CUSTOMER SERVICE:** For service on your magazine subscriptions, including change of address, write to Customer Service Manager **ROBERT AUSTIN**, P.O. Box 10628, Des Moines, IA 50336. Please enclose a recent address label.
© COPYRIGHT MEREDITH CORPORATION 1986. ALL RIGHTS RESERVED. PRINTED IN U.S.A.

"I MADE IT!"

YOURS FOR ONLY

\$1.95

plus postage and handling.



No other statement creates such a feeling of pride and accomplishment. And no other book makes building *more than 150 projects* yourself as easy as BACKYARD BUILDER.

You'll find detailed plans, material lists, step-by-step instructions, easy-to-follow illustrations and helpful trade secrets for . . .

benches . . . window greenhouses . . . fences . . . wheelbarrows . . . trellis systems . . . bike racks . . . cabinets and cupboards . . . free standing shelves . . . vegetable bins . . . and much, much more.

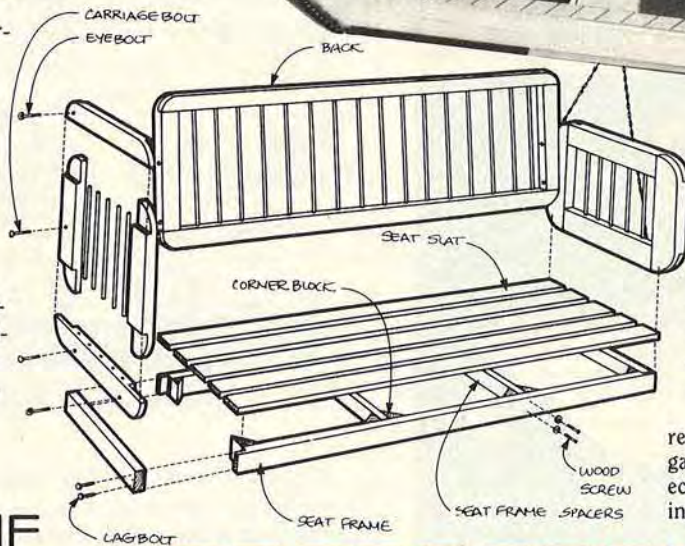

TRY IT FREE FOR 15 DAYS

This extraordinary offer is our way of introducing you to RODALE'S PRACTICAL HOMEOWNERS BOOK CLUB—the club that *saves you up to 40% and more* on some of the best books available for your home.

You'll find a *large selection of books* on remodeling your home . . . growing a great garden . . . energy options . . . building projects . . . landscaping . . . furniture refinishing . . . and much, much more.

HOW THE CLUB WORKS:

As a member, you'll receive our Club Bulletin every four weeks. It includes a special Editors' Selection and a wide variety of books (up to 90!) covering every aspect of your home.

If you want to receive the Editors' Selection, you don't have to do anything—we'll ship it to you automatically. If, however, you want another selection—or no books at all—we'll follow the instructions you check on the reply form provided with each Bulletin. You never have to buy a book you don't want. Each book comes with a free 15-day examination.

YES!

Please send me a copy of BACKYARD BUILDER and enroll me in RODALE'S PRACTICAL HOMEOWNERS BOOK CLUB. I understand you'll bill me for only \$1.95 plus shipping. I agree to purchase two more books at special club discounts during the coming year and may resign anytime after that.

717

NAME _____

ADDRESS _____

APT.# _____

CITY _____

STATE _____

ZIP _____

RODALE'S PRACTICAL HOMEOWNERS BOOK CLUB
P.O. BOX 10627, DES MOINES, IA 50336

SS843

18" HEAVY DUTY BAND SAW!



**EASTCOAST
WAREHOUSE
GRAND OPENING
SPECIAL!**

This offer subject
to withdrawal
without notice.

- Weighs 500 Lbs.
- 2 H.P. Single Phase 220v Motor
- Magnetic Overload Protection Switch
- All Ball-Bearing Drive
- Comes Complete With Miter Guage, Rip-Fence & Stand
- 1½" x 121" Blade

Regularly Priced at \$595.00

NOW ONLY \$525.00

F.O.B. BELLINGHAM, WA OR WILLIAMSPORT, PA



Grizzly™ IMPORTS, INC.

P.O. BOX 2069
BELLINGHAM, WA 98227
(206) 647-0801

2604 REACH ROAD
WILLIAMSPORT, PA 17701
(717) 326-3806
(OPENING JAN. 2, 1987)



HEGNER OUTPERFORMS...

HEGNER PRECISION SAWS combine uncompromising quality, the lowest blade-breakage rate, and the longest proven performance — for the best value in a scroll saw.

AMI — because you never regret quality!

Call or write for complete information:

**ADVANCED
MACHINERY
IMPORTS LTD**

P.O. Box 312; Dept. 118
New Castle, DE 19720
302 • 322 • 2226

TALKING BACK



We welcome comments, criticisms, suggestions ...even an occasional compliment. The volume of mail we receive makes it impossible to answer every letter, but we promise to do our level best. Send your correspondence to: Letters Editor, WOOD Magazine, Locust at 17th, Des Moines, IA 50336.

NEVER A THICKENING MACHINE BE

Of all things, a thickening machine and an article about thicknessers (Oct. 1986, pgs. 56-61). Why not call it a planer — a term that any woodworking person would understand? I grew up in a wood mill-work operation — it was always a planer — never a thickening machine.

C.F. VanBuskerk, New Castle, Ind.

Mr. VanBuskerk, you raise a valid question. But rest assured our tool specialists wrestled with these names a long time before deciding to call them thicknessers. Their intent was to establish a definitive name and to eliminate some of the confusion and misunderstanding that exists.

JOINTER

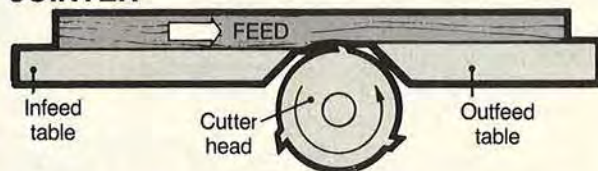

THICKNESSER

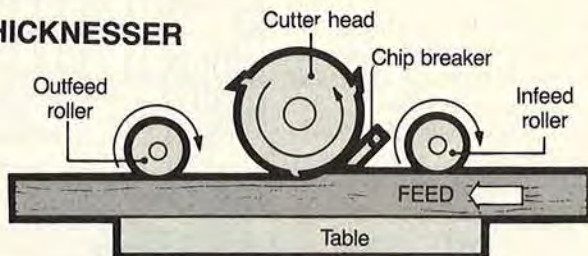

While certain machines perform only one function, namely planing (or thickening) wood to a particular dimension, some of the newer machines now being sold are able to do more than just this one operation. We believe that "thicknesser" is a more encompassing term to use.

Basic thicknessers reduce lumber to size with a finished surface. The convertible jointer-thicknessers joint warped or twisted boards and reduce wood thickness. And the third group, the molder-thicknessers, can cut fancy moldings and plane.

Some folks also confuse jointers and thicknessers. As the above illustration shows, the cutter heads on a jointer operate below the feed table, while on a thicknesser, the cutter head operates above the feed table. Thicknessers also have pressure rollers or bars that force the wood against the table.

Continued on page 10

SQUARE IT™

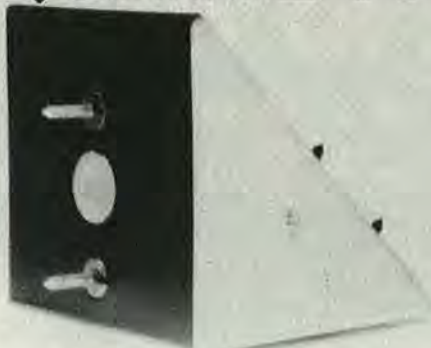

Square it™ is a newly patented electronic precision square with a guaranteed accuracy of 5/10,000 of an inch. Designed, engineered & made in America, **Square it™** is a rugged 3/4 pound precision instrument that's totally portable & built to last. **Square it™** is preset at exactly 90° & 45°. **Square it™** fulfills a universal need of woodworkers to square any tool easily & with great accuracy. There is never a guess or a question of accuracy with **Square it™**, when the light goes on you know its precisely 90° or 45°. **Square it™** will perfectly square the following tools: Table saw, Radial arm saw, Jointer, Bandsaw, Drill Press, Shaper, Disk Sander, Belt Sander, Router, or any stationary machine or hand held tool where a 90° or 45° relationship should occur. The introductory special of **Square it™** comes complete with: accuracy documentation papers, 18 page manual, Krypton bulb, Alkaline batteries and a 100% warrantee, \$76.50 ppd. The **Square it™** manual is fully illustrated with detailed drawings & easy to follow step by step instructions for a quick & accurate squaring up of your shop tools. (Example, squaring up for a table saw 10-15 seconds, Jointer 30-45 sec., Radial arm saw 35-60 sec.) For manual alone please send in \$5 check. For both **Door Shop™** & **Square it™** manuals send in \$8.50 check.

Dealer inquires are invited.

THE DOOR SHOP™

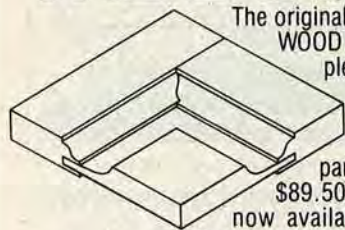

The original Ogee **DOOR SHOP™** as featured in WOOD MAGAZINE (MAY/JUNE 85) is complete with stile & rail, slot & panel raising bits for the 1/4" chuck router. Bits are carbide tipped & BB & will make 3/4" thru 2 1/4" thick raised panel doors. **Door Shop™** & Manual \$89.50 ppd. The 1/2" shank **Door Shop™** now available. Call about our 5 piece **Door Shop™** special.

The 37 page **DOOR SHOP™** MANUAL is clearly written and beautifully illustrated with over 156 detailed drawings covering the complete process of door building. Each section covers proper methods and exact set ups for the router, including how to recognize and correct for errors. There are sections covering Design, Lumber selection, Measuring, Panel Raising, curved & straight Rail and Stile cutting & fitting, Guides, Clamping, Gluing and Finishing. This is the most comprehensive manual out today. When purchasing the **Door Shop™** manual for \$5.00 you also receive Zac's 26 page Router bit and Shaper cutter catalog free.

Zac's carbide tipped **PANEL RAISER™** router bits come in 3 styles; OGEE, COVE, & PROVINCIAL. All 1/2" shank bits are 3 1/2" in diam., with BB & give a full 1 1/2" raised panel \$90 @ or all 3 bits for \$235 ppd. All 1/4" shank bits larger raised panel cut. \$65 @



TO ORDER
CALL 800-441-0101

IN NY 212-645-9494

ZAC PRODUCTS INC. 34 Renwick Street NYC, NY 10013

CARBIDE TIPPED ROUTER BITS —SPECIAL WINTER SALE— PROFESSIONAL PRODUCTION QUALITY WHEN ORDERING ANY THREE OR MORE DEDUCT \$2.00 EACH

1000's SOLD TO READERS OF FINE WOODWORKING

BEST CUT BEST PRICE	ITEM NO.	DESCRIPTION	RADIUS	LARGE DIAM.	CUTTING LENGTH	PRICE
	COVE					
	#01	1/4" R	1/4"	1"	1/2"	\$13.00
	#02	3/8" R	3/8"	1 1/4"	9/16"	14.00
	ROUND OVER					
	#04	1/4" R	1/4"	1"	1/2"	15.00
	#05	3/8" R	3/8"	1 1/4"	5/8"	16.00
	ROMAN OGEE					
	#07	5/32" R	5/32"	1 1/4"	15/32"	18.00
	#08	1/4" R	1/4"	1 1/2"	3/4"	20.00
	RABBETING					
	#11	3/8"	Deep 3/8"	1 1/4"	1/2"	14.00
	#09	1/8" (KERF) SLOT CUTTER		1 1/4"	1/8"	14.00
	KERF SLOT CUTTER					
	#10	1/4" (KERF) SLOT CUTTER		1 1/4"	1/4"	14.00
	#12	45° CHAMFER	45° Angle	1 1/2"	5/8"	15.00
	RAISED PANEL					
	#15		20° Angle	1-5/8"	1/2"	25.00
	#35	1/4" V Groove 90°		1/4"	1/4"	8.00
	V GROOVE 90°					
	#36	3/8" V Groove 90°		3/8"	3/8"	9.00
	#37	1/2" V Groove 90°		1/2"	1/2"	11.00
	DOVETAILED					
	#16	3/8" Dovetail 9°		3/8"	3/8"	7.50
	#17	1/2" Dovetail 14°		1/2"	1/2"	8.50
	DOVETAILED					
	#18	3/4" Dovetail 14°		3/4"	7/8"	10.50
		CORE BOX (ROUND NOSE)				
#19		3/8" Core Box	3/16"	3/8"	3/8"	11.00
#20		1/2" Core Box	1/4"	1/2"	11/32"	14.00
	CORE BOX					
	#21	3/4" Core Box	3/8"	3/4"	5/8"	18.00
		GROOVE FORMING OGEE				
#22		1/2" Grooving Ogee		1/2"	3/8"	16.50
#23		3/4" Grooving Ogee		3/4"	7/16"	21.00
	STRAIGHT BIT					
	#24	1/4" Straight Bit		1/4"	3/4"	7.00
	#25	5/16" Straight Bit		5/16"	1"	7.00
	#26	3/8" Straight Bit		3/8"	1"	7.00
	#27	1/2" Straight Bit		1/2"	1"	7.00
	FLUSH TRIM					
	#28	3/4" Straight Bit		3/4"	1"	10.50
	#13	1/2" FLUSH TRIM		1/2"	1"	8.50
	KEY HOLE					
	#14	3/8" KEY HOLE (This Bit only HSS)		CUTS 3/8" KEY HOLE FOR FLUSH MOUNTING PICTURE FRAMES, ETC.		8.50

ALL PRICES POSTAGE PAID

- Professional Production Quality • 1/2" Ball Bearing Pilot
- 1/4" Diameter Shanks × 1 1/4" Long • One Piece Construction
- Two Flute Thick High Quality Tungsten Carbide Tips

To order by MasterCard or Visa Toll Free
7 Day—24 Hour Order Service Call
1-800-523-2445 Ext. 56 (In PA 1-800-346-7511 Ext. 56)
or send check to:

MLCS, P.O. Box 53D, Rydal, PA 19046

WOODWORKERS HARDWARE

WHOLESALE ORDER FORM

Pt. No. Price Pt. No. Price Pt. No. Price

WOOD WHEELS	
W075 100	3/4" \$3.50/100
W087 100	7/8" \$4.70/100
W100 100	1" \$6.00/100
W125 100	1 1/4" \$8.00/100
W150 100	1 1/2" \$11.00/100
W175 100	1 3/4" \$15.60/100
W200 100	2" \$19.50/100
W225 20	2 1/4" \$7.30/20
W250 20	2 1/2" \$8.80/20
W275 20	2 3/4" \$10.20/20

WHEEL PEGS	
AP1 fits 1"-2"	\$4.10/100
AP5 fits 2 1/4"-2 3/4"	\$1.98/20
1741	4" PLASTIC SPOKE WHEEL \$.90/ea

LITTLE PEOPLE 2-3/8" Birch	
LP3 Men	\$2.46/10
LP4 Women	\$2.46/10

TOY CARGO	
433 Pickle Barrel	\$2.31/10
434 Oil Drum	\$2.31/10
435 Milk Can	\$2.15/10

JIGGLE EYES	
88060	1/4" \$1.40/144
88010	3/8" \$1.70/144
88120	1/2" \$2.00/144
88200	4/5" \$4.10/144

BIRCH PEGS	
MGP1	3-3/8" \$27/ea
7226	3/2" \$15.00/100
1770	3-3/8" \$18/ea
1771	2 1/2" \$17/ea
7227	1 3/4" \$11/ea
SKP2	3/2" \$7.60/100
Dak	3/2" \$3.00/ea
	\$28.00/100

BIRCH SPINDLES	
S6	5 1/4" \$42/ea
S85	9" \$72/ea
S110	11" \$117/ea

GALLEY SPINDLES	
S1 Birch	1-1/8" \$10/ea
S10ak	1-1/8" \$12/ea
S4 Birch	1 1/4" \$17/ea
S40ak	1 1/2" \$24/ea

DOWEL PIN	
1142	Birch \$1.90/100
1/4" x 2"	\$8.50/500
1382	\$2.00/100
3/8" x 2"	\$9.00/500

GAME PEGS 3/16"x1"	
316N	\$1.20/100
	\$9.95/1000

SCREW HOLE BUTTONS	
1432	3/8" \$1.76/100
Birch	\$7.50/500
1434	1/2" \$1.76/100
Birch	\$8.00/500
1452	3/8" \$3.70/100
Oak	\$15.50/500
1454	1/2" \$3.80/100
Oak	\$16.00/500

WOOD CANDLE	
CC1	BIRCH CUP \$3.31/ea

BRASS PLATED CANDLE	
718	1-13/16" CUP \$18.00/100

BRASS EAGLES 2"	
878	\$2.16/10

CLOCK MOVEMENT W/HANDS	
Q-82	1-4 \$6.48/ea
	5-9 \$5.10/ea
	10-24 \$4.55/ea
	25+ \$3.95/ea

CLOCK DIAL	
1772	5" PLASTIC \$1.80/ea

CORD SETS	
CS6	6" \$1.00/ea
CS8	8" \$1.10/ea

PUSH-THRU LAMP SOCKET	
940	\$1.49/ea

LAZY SUSAN BEARINGS	
LC3	3" \$3.69/ea
LC4	4" \$1.00/ea
LC6	6" \$2.05/ea
12C	12" \$5.99/ea

CLIPBOARD CLIPS	
L5	3" \$5.55/ea
ST6	6" \$7.75/ea

MAGNETIC STRIP	
120A	120"x1/2" \$4.40/Roll

CORK SHEETS	
C31	8 1/2"x11" \$60/ea

PLASTIC GLASS	
357	5"x7" \$3.35/ea
380	8"x10" \$6.55/ea
314	11"x14" \$1.20/ea

SHELF PINS	
517	\$5.40/100

RING HANGER	
6303	\$3.29/10
	\$26.97/100

BRASS PLATED PICTURE HANGER	
S23	\$4.70/100

MINI HANGER	
7247	5/8" \$2.60/100

SAW TOOTH PICTURE HANGERS	
S59	1-5/8" \$4.17/100
S60	2 1/4" \$4.50/100
406	Self Fastening \$4.77/100

PRONG HANGER	
7248	\$2.90/100

SOLID BRASS CUP HOOKS	
812	1/2" \$6.70/100
858	5/8" \$7.60/100
834	3/4" \$8.60/100
835	7/8" \$8.70/100
836	1" \$10.60/100

6" BRASS & PORCELAIN HOOKS	
6417	Three Prong \$5.85/ea
6416	Two Prong \$2.97/ea

BLACK HAMMER HINGE W/SCREWS	
1730	\$1.62/2
	\$7.17/10

BRASS PLATED HINGES	
910	1" \$1.30/10
928	1 1/2" \$2.25/10

SCREWS FOR ABOVE	
F124	\$2.40/100

PRODUCTION SCREWS	
6277	1 1/4"x#6 \$1.70/100
6278	1-5/8"x#6 \$1.90/100
6279	2"x#6 \$2.50/100
6282	3"x#8 \$4.75/100

CARPENTERS GLUE	
E705	\$11.37/Gal.

SAND PAPER SHEETS 9"x11"	
81220	220gr \$16.75/100
81150	150gr \$16.80/100
81120	120gr \$16.90/100
81100	100gr \$17.20/100
81080	80gr \$11.50/50
81060	60gr \$11.60/50
81050	50gr \$11.70/50
81234	Assort \$16.50/70

SANDING BELTS	
1700	120gr \$12.20/10
1701	80gr \$13.00/10
1702	50gr \$13.50/10
1703	36gr \$14.65/10
3"x24"	
1704	120gr \$13.10/10
1705	80gr \$13.50/10
1706	50gr \$14.60/10
1707	36gr \$15.85/10

TALKING BACK

Continued from page 8

KEEP SAFETY FOREMOST IN MIND!

In the October issue of WOOD, a reader suggested using shampoo bottles to store tung oil. Please remind others that transferring such materials from their original containers removes critically important safety considerations designed into the package and label. Each year thousands of children are poisoned by chemicals they find in their home. Proper containers are the first step in preventing such accidents. Having label information, such as ingredients and first-aid instructions, can be very critical in treating a poisoning victim.

Richard Drew, Durham, N.C.

Thanks for reminding us about the safety aspects of that suggestion, Richard. We work hard to prevent accidents with our power tools. We also need to safeguard against accidents with the hazardous materials used in the shop. It might be a good idea if we all double-check our storage facility. Although it may be safe enough for us, we should realize there may be visitors, particularly exploring grandkids and others, who are not aware of the potential hazards. A surprising number of products commonly used in a shop have potentially hazardous ingredients. To determine which ones, check the labels. Look for key signal words such as "acid", "danger", and "poison", that warn of any toxic contents. Also read the directions for storing and handling — these sometimes tip you off as to hazards a product presents. If you're still in doubt about a product, ask your dealer.

WHEN TO STICKER DRY WOOD

Regarding your reply to the question on how to separate stacked boards on page 90 of the June, 1986 issue: The U.S. Department of Agriculture's Forest Products Utilization Technical Report #6 recommends stickers be placed directly above each other. If not, sags will develop in the boards where weight bears on unsupported areas.

Robert E. Jacques, Carlisle, Pa.

Robert, your letter prompted us to call the experts at the U.S. Forest Products Laboratory in Madison, Wis. They told us you can safely stack dried lumber without stickers as long as it stays dry. In fact, many commercial factories solid-stack dry wood, without stickers, when they know it will be used within a reasonably short time. And, many woodworkers routinely solid-stack wood in their shops.

But green lumber must be stickered, and as you point out, with the stickers placed directly above each other to eliminate any possibilities of the boards warping. For other details on drying lumber, read the article, Air-Drying Green Wood, starting on page 64 in this issue.

ORDER TOLL FREE 1-800-441-9870 MN 1-612-472-5544

Send \$1.00 for Catalog or \$5.00 for Catalog plus Best Selling plan package (\$10.00 value) or order directly from this ad by phone or mail. HOW TO ORDER: State quantity, part number, item, price, and total of order. Send check, money order, or Visa or M.C. number and Exp. date. Shipping: \$25.00 to \$49.99 add \$3.50, \$50.00 to \$99.99 add \$4.50, Over \$100.00 add \$5.00. MN. Res. add 6% tax. Minimum order \$25.00.

Please send me: Catalog \$1.00 Catalog and Plan Package \$5.00
 Print Name _____ Phone # () _____
 Address _____
 City _____ State _____ Zip _____

Your workshop can PAY OFF ... BIG!

SAVE... convert low cost rough lumber for use in your home projects

OR

EARN EXTRA INCOME by supplying custom Planed Lumber, trim, and molding to lumberyards... contractors... cabinetmakers... home hobbyists and others...



**SAVE!!
FACTORY
PRICES
DIRECT TO
YOU**

Try The
Foley-Belsaw In Your
Own Shop On Our
**30-DAY FREE
TRIAL OFFER**
Mail Coupon Below
For Complete
Details!

SAWS to desired width...

PLANES to any thickness...

MOLDS Popular Patterns

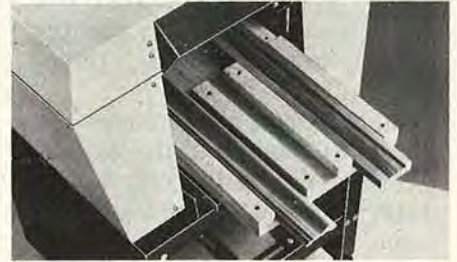
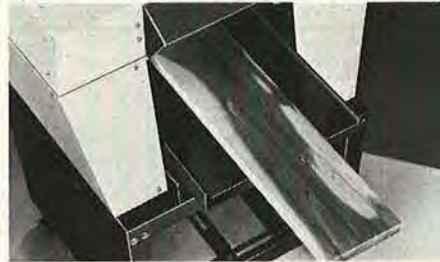

You can rip, plane and mold... All with Automatic Power Feed!

From the Day It Arrives... the Planer will make and save you money. With shortages and inflation driving lumber prices sky-high, this versatile power tool quickly pays for itself by easily converting low cost rough lumber into high value finished stock. In just one pass turn out your own quarter-round, door and window stop, casing, tongue-and-groove... all popular patterns. Other operators are making cases for grandfather clocks, furniture, picture frames, bee hives, bed slats, surveying stakes... all kinds of millwork.

Built For Pros... Priced For Home Craftsmen... it is engineered and built to industrial standards, but factory-direct selling keeps the price low. Handles tough oak and walnut as easily as pine, and so simple to operate even beginners with no experience can use it.

Start Your Own Business... with just this one low cost power-feed machine in a corner of your garage or basement, you're set up to supply lumberyards, cabinetmakers, carpenters, remodelers, contractors and hobbyists in your area with custom-planed lumber, trim, molding... ALL of their millwork requirements. You can supply picture molding to art shops, hardware and department stores, or sell direct to framing shops. All standard patterns are available from stock, or we'll custom grind a knife to your own special design or sample.

FREE BOOKLET!
Get FREE Book with facts and full details... **RUSH COUPON TODAY!**

Now You Can Turn Extra Time Into Extra Income! FOLEY-BELSAW POWER TOOLS

If coupon has been removed, just send postcard with name and address to:

FOLEY-BELSAW CO.
90969 FIELD BLDG.
KANSAS CITY, MO 64111

**Just Mail Coupon . . .
NO OBLIGATION and
NO SALESMAN Calls!**

**ACT NOW!
Coupon
Brings
Full Details!**



FOLEY-BELSAW CO.
90969 FIELD BLDG.
KANSAS CITY, MO 64111

YES, please send me the FREE Booklet that gives me complete facts about your Planer-Molder-Saw and full details on how I can qualify for a 30-Day Free Trial right in my own shop. I understand there is No Obligation and that No Salesman will call.

Now You Can Turn Extra Time Into Extra Income! FOLEY-BELSAW POWER TOOLS

NAME _____
ADDRESS _____
CITY _____ STATE _____ ZIP _____

In woodworking, as in life, no one knows it all. But through experience, we all discover — or stumble onto — better, safer, faster, or easier ways to do things. When we devise interesting tips or techniques, we'll share them with you in this column. And when you send us your favorites, we'll pay you \$25 for each submission we publish. No shop tips can be returned. Mail your tips to:

Shop Tips
Better Homes and Gardens®
WOOD Magazine
Locust at 17th
Des Moines, IA 50336

BORROWED FROM THE FAMILY SEWING KIT

Ripping various widths of material on a radial arm saw requires a lot of setup time. How can you speed things up?

TIP: With the radial arm blade set for ripping, turn on the saw, lower the blade, and cut a 1/16"-deep groove in the tabletop. Then pull the blade slowly toward and then away from you to create a dished-out groove.

Glue a paper or cloth tape measure to the bottom of the groove. When you're ready to rip, set the blade so that it just clears the scale. Now you don't need to raise and lower the blade each time you set up to rip a different width of material.

— Fred Schwend, Mira Loma, Calif.

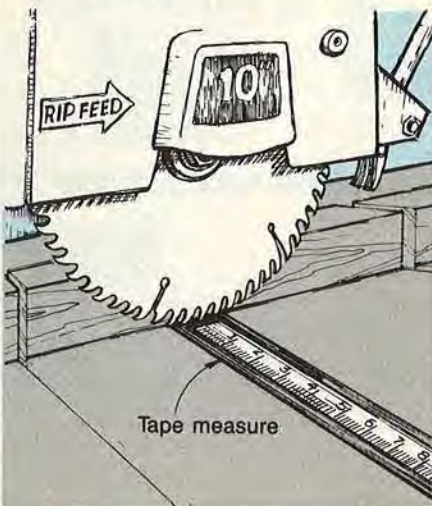

WHOOPS! OUR MISTAKE

We found an error in one of the shop tips on page 14 of our last issue (December, 1986). The tip, from Robert A. Grace, St. Joseph, Mich., shows how you can tell if you're drilling level with spade bits. You slip a washer over the drill bit shaft. If the washer neither climbs up nor walks down the shaft, you are holding the bit level, as shown in the drawing *below*. In the last issue, we ran the drawing *sideways*, with the bit pointing *down*. If you saw this drawing, you might have wondered how we made the washer defy the law of gravity! The drawing *below* should clarify things.

— From the WOOD shop

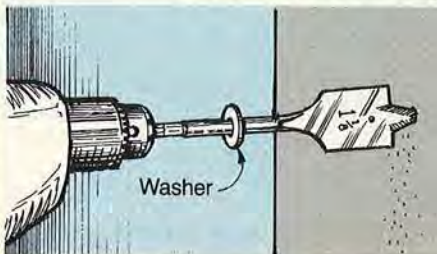

SLIP-SLIDING AWAY NO MORE

Small workpieces can be hard to clamp or fasten to the workbench for sanding or planing.

TIP: Use double-faced tape to secure strips of used sanding belts — the coarser, the better — to your workbench top. The sandpaper helps keep pieces of wood stationary while you safely sand or plane them. This trick works especially well if you need both hands to operate the tool.

— From the WOOD shop

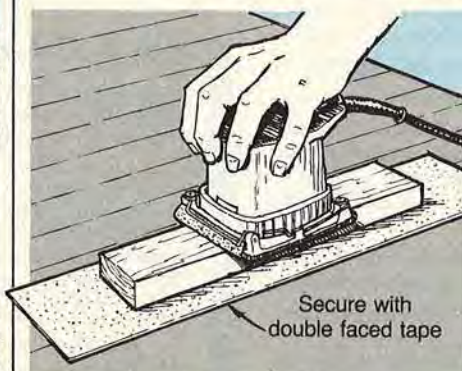

DO THE CLAMPING TWO-STEP

Unless you have help, struggling with pipe clamps to clamp a mitered box or frame for glueing can be tough.

TIP: Call a strap clamp to the rescue. Glue and assemble the project at the workbench. First secure it with a strap clamp and then beef up the clamping process with pipe clamps, as shown.

— From the WOOD shop

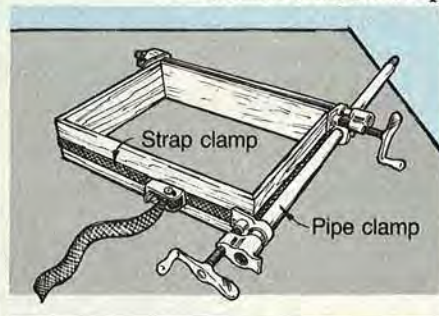

THE ELIMINATOR

Vibrating metal power-tool bases, stands, and cabinets create a lot of noise pollution in the shop.

TIP: Here's how you can cut out a lot of that noise permanently in short order. Disassemble the stand or base and apply a bead of a good, low-shrinkage construction adhesive — Franklin's Premium 5661 is one brand — anywhere metal parts touch. When it's reassembled, you should notice quite a substantial reduction in noise when the machine runs.

— Robert M. Vaughan, Roanoke, Va.

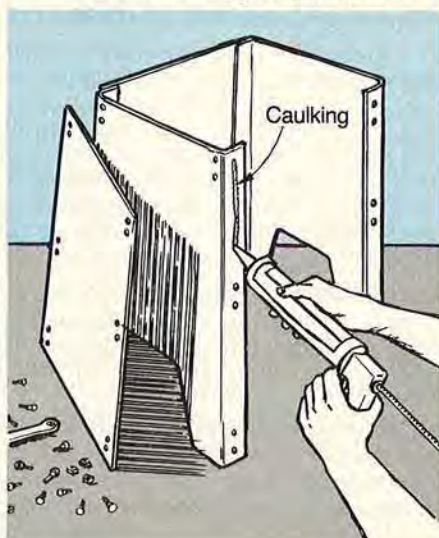

Continued on page 20

RYOBI TOOLS		List	Sale
S500A	3x5 1/2 Finish Sander	70	41
SUR200	Finishing Sand. 1/2 Sheet	142	86
87075	3x21" dustless Belt Sand.	179	116
87100	3x24" dustless Belt Sand.	208	140
87200A	4x24" dustless Belt Sand.	269	165
D100WR	3/8" VSR 0-1200 rpm drill	91	49
W640	7/16" 13 amp circular saw	158	99
W740	8 1/4" 13 amp circular saw	171	109
J560	Jig Saw-Single Speed	172	99
J560J	Jig Saw-electronic v/speed	198	123
R150	1 H.P. Plunge Router	138	86
R330	2 H.P. Router	220	138
R500	3 H.P. Router	265	163
E3800	Drywall screwdriver 0-4000	126	79
L120U	3/8" Planer	142	89
BD1020R	3/8" 2-spd Cordless Drill w/ree holster-Xtra special buy	148	95
TS251U	10" Mitre Box	300	169
SG1150C	4 1/2" H.D. Mini-Grinder	99	59

YOUR ATTENTION PLEASE!
All Above RYOBI OFF Prices
Take Additional 10% **TOOL SALE** Prices

MILWAUKEE TOOLS		List	Sale
0224-1	3/8" drill 4.5A magnum	173	109
0234-1	1/2" drill 4.5A magnum	173	112
0244-1	1/2" drill 4.5A magnum	173	115
0222-1	3/8" drill 3.3A 0-100 rpm	159	99
0228-1	3/8" drill 3.3A 0-1000 rpm	139	92
0375-1	3/8" close quarter drill		
	— NEW — 3.5 amp	191	118
0210-1	3/8" cordless drill		
	— NEW — 2 speed	189	95
6539-1	cordless screwdriver		
	— NEW — 190 RPM	99	59
1007-1	1/2" drill 4.5A D-Hole	217	145
1107-1	1/2" drill 4.5A D-Hole	222	145
3300-1	magnum rt angle drive kit	271	170
3102-1	Plmbrs rt angle drill kit	287	180
1676-1	HD Hole Hawg w/cse 2 sp 363	235	155
5395	3/8" sgle sp hammer drill kit	203	150
5397	3/8" var sp hammer drill kit	208	155
5371-1	HD mag. hammer drill 1/2"	313	207
5373	HD mag. hammer drill 3/8"	262	175
6511	2 speed Sawzall w/case	197	122
6226	port band saw 2 sp w/case	416	280
6234	TSC band saw port w/case	416	280
6405	8 1/4" circ. saw 13 amp	191	127
6460	10 1/4" 15 amp w/case	390	245
6165	1/2" Chop saw 15 amp		
	4200 R.P.M.	311	189
6255	v/sp Jig Saw 3.8 amp	217	140
6245	sgle sp Jig Saw 3.8 amp	191	125
6012	1/4" sheet HD Orb. sander	173	110
6014	1/2" sheet HD Orb. sander	184	112
5660	1/2" HP router 10 amp	289	175
5680	2 HP router 12 amp	342	220

DRYWALL SHOOTERS		List	Sale
6753-1	3.5 amp 0-4000 rpm new	125	79
6747-1	4.5 amp 2500 rpm	157	100
6750-1	4.5 amp 0-4000 rpm	141	90

NEW FROM RYOBI
MODEL AP-10 — 10" Surface Planer
WEIGHS ONLY 58 LBS.
LIST \$659.00 — SALE \$375.00

MILWAUKEE Super Specials!		List	Sale
** BRAND NEW **			
Model 0212-1 Cordless Variable Speed 3/8" Drill			
LIST	..209.00	SALE	..125.00
Model 6145 — 4 1/2" Sander-Grinder			
LIST	..149.00	SPECIAL SALE	..85.00
Go Cordless with MILWAUKEE			
#6305 — 6 1/4" Cordless Circular Saw			
12 volt — 1 Hour Charge			
Cuts (80) 2x4's (Pine)			
List Price \$229.00 * SALE PRICE \$119.00			

FREUD SAW BLADES		List	Sale
Univ. Bore — Professional Series			
CARBIDE TIPPED SAWBLADES			
Item No.	Description	Diam.	Teeth
PS203	Gen'l Purp.	7 1/2"	24
PS303	Fin. cutting	7 1/4"	40
5/8" Bore — Industrial Grade			
CARBIDE TIPPED SAWBLADES			
Item No.	Description	Diam.	Teeth
LU72M010	Gen'l Purp.	10"	40
LU81M010	Gen'l Purp.	10"	60
LU73M010	Cut-Off	10"	60
LU82M010	Cut-Off	10"	60
LU84M010	Combination	10"	60
LU84M011	Combination	10"	50
LU85M010	Super Cut-Off	10"	80
LM72M010	Ripping	10"	24
DS 306	6" Dado	139.00	92
DS 308	8" Dado	170.00	105
TR 100	3 blades & Dado set	399.00	255

MAKITA CORDLESS FESTIVAL OF VALUES		List	Sale
4300DW	Jig Saw	158	99
5081DW	3/8" Saw Kit	174	95
5600DW	6 1/4" Circular Saw	224	125
9035DW	Finishing Sander	128	73
6010DWK	3/8" Cordless Drill Kit	152	88
6010SDW	3/8" Cordless Drill	84	45
8400DW	3/8" Hammer Drill	188	105
DA3000DW	3/8" Angle Drill	176	99
6010DL	3/8" Drill w/Flashlight	162	89
6012HDW	3/8" 2 spd Driver Drill w/Bat & Metal Case	178	98
DK1002	3/8" Drill w/Fluorint Lt.	164	90
5008NBA	Cordless Screwdrvr Kit	184	84

LEIGH DOVETAIL JIGS		List	Sale
T0514		149	125
T0514L		199	195
D1258-12		299	245
D1258-24		359	275

MAKITA BRAND NEW X-TRA SPECIAL		List	Sale
5007NBA	7 1/4" Saw w/Elec. Brake	186	115
5008NBA	8 1/4" Saw w/Elec. Brake	212	130

MAKITA TOOLS		List	Sale
80451S	Sander	86	43
99008	3" x 21" belt sander	218	119
9924B	3" x 24" belt sander	208	130
99240B	3" x 24" b/sand. w/bag	234	130
9035	1/2 sheet finish sander	88	48
9045E	1/2 sheet finish sander	184	90
9045N	1/4 shif. fin. sand. w/bag	184	105
4200N	4 3/4 circ. saw 7.5 amp	168	93
5008NB	8 1/4 circ. saw 13 amp	198	105
5201NA	10 1/4 circ. saw 12 amp	298	215
4300WB	v/sp jig saw 3.5 amp	218	120
4301WB	orb v/sp jig saw 3.5 amp	230	125
JR3000WL	2 sp recip saw w/cse	188	120
JR3000V	vs recip saw w/case	198	120

MAKITA TOOLS ** SPECIAL PROMOTION
LS1000 New 10" Mitre Box 368 198
792210-7A Carbide Bid for above 49 31
9820-2 Blade Sharpener 268 159
741074-9 60 (coarse) Grdg Whl 33 23
741070-7 1000 (med) Grdg Whl 31 22
741071-5 6000 (fine) Grdg Whl 43 30

BELT SANDERS by PORTER CABLE		List	Sale
#314	4 1/2" Trim Saw	109	59
List 180		SALE 109	
#346-1	6 1/2" Top Hdle	161	100
List 161		SALE 100	
#617	7 1/4" Push Hdle	166	96
List 166		SALE 96	
#587	7 1/4" Speedronic	199	125
List 199		SALE 125	
#315-1	7 1/4" Top Hdle	166	96
List 166		SALE 96	
#368-1	8 1/4" Top Hdle	176	110
List 176		SALE 110	

DELTA — BRAND NEW		List	Sale
34-080	10" Miter Box w/rotary table	279	179
Repeat of a Sellout			
DELTA — SUPER SPECIAL			
40-601	18" Electronic v/sp scroll saw — complete	1117	679

WE NOW HAVE A COMPLETE STOCK OF BOSCH CARBIDE TIPPED SHAPER CUTTERS
ALL SALE PRICES AT 40% OFF LIST.
buying from Seven Corners Hdw. is a good Rule to follow.

Model	STANLEY List Sale
33-116 PL-316 3/4" x 16"	15.95 7.50
33-320 PL-320 3/4" x 20C	16.95 7.95
33-425 PL-425 1" x 25"	18.95 8.95
33-430 PL-430 1" x 30"	20.95 9.95

1987 TOOL CATALOG AVAILABLE
Call Toll-Free 1-800-328-0457 — In Minnesota Call (612) 224-4859
4 WAYS TO BUY: CHECK — MONEY ORDER — VISA — MASTERCARD
SEVEN CORNERS ACE HDW., INC.
216 West 7th St. - St. Paul, MN 55102 - Est. 1933

SAW-ATHON by PORTER CABLE

Model	List	Sale
#314	4 1/2" Trim Saw	109
List 180		SALE 109
#346-1	6 1/2" Top Hdle	161
List 161		SALE 100
#617	7 1/4" Push Hdle	166
List 166		SALE 96
#587	7 1/4" Speedronic	199
List 199		SALE 125
#315-1	7 1/4" Top Hdle	166
List 166		SALE 96
#368-1	8 1/4" Top Hdle	176
List 176		SALE 110

DELTA #34-10 — 10" CONTRACTORS SAW
w/Stand & 1 1/2 H.P. Motor
SPECIAL PRICE \$679.00
FACTORY REBATE 100.00
579.00
FREE DELIVERY TO 48 STATES

TOOLS ON SALE
AMERICA'S LOWEST PRICED TOOLS
★ PLUS — FREE FREIGHT ON EVERY ITEM

SUPER CORDLESS SPECIALS from BLACK & DECKER		List	Sale
1930	3/8" rev/hl speed	165	110
1950	3/8" High Torque	165	110
5930	Reversible Hammer	179	120
1970	3/8" rev/hl torque screwdriver	179	120
1980	Rev/adj. clutch Scruddrill	179	120

BRAND NEW! SUPER SPECIALS from MILWAUKEE		List	Sale
0214-1	3/8" c/less drive/drill	189	109
8975	H.D. heat Gun, 11.6A Low 570°F - High 1000°F	81	49
5920	belt sander 3x24 w/o bag	315	199
5925	belt sander 3x24 w/bag	315	215
5930	belt sander 4x24 w/o bag	326	209
5935	belt sander 4x24 w/bag	348	214

PORTER-CABLE = NEW ITEMS +		List	Sale
655	Drywall Driver 0-4000 Rev	115	85
367	3 1/4" Plane 6.5A	170	115
5009	Mortise & Tenon Jig	50	34
351	3" x 21" Belt Sander	189	125
352	3" x 21" Belt Sndr w/bag	199	135
9810	Cordless Screwdrvr kit	175	115
320	Abrasibe Plane 3A	129	91

★ ROUTER RIOT ★ by PORTER-CABLE		List	Sale
100	7/7 H.P. 6.5 amp	141	98
630	1 H.P. 6.8 amp	150	100
690	1 1/2 H.P. 8 amp	194	130
691	1 1/2 H.P. D-Hdle 8 amp	218	145
536	1 1/2 H.P. Speedmatic Double Handle	300	190
537	1 1/2 H.P. Speedmatic Double Handle	315	215
520	3 H.P. Production	460	270
518	3 H.P. Microcompressor 5-sp	490	345

TRIMMERS by PORTER-CABLE		List	Sale
309	3.8 amp laminate trimmer	130	90
310	3.8 amp laminate trimmer	190	135
312	offset base laminate trim	205	140
319	lilt-base laminate trim	215	150

★ X-TRA SPECIALS ★ MAKITA TOOLS		List	Sale
6010DL	C/less Drill w/flashlight-charger & case	174	90
DP3720	3/8" drill Rev. 0-1800 rpm	98	47
6510LVR	3/8" drill Rev. 0-1500 rpm	136	67
6013BR	1/2" Drill rev. 6 amp	198	100
5402A	16" Circular Saw 12-amp	518	315
2414	14" Cut Off Saw-13 amp	308	169
3612BR	3 HP Plunge Router	318	175
9401	4x24 belt Sander w/bag	268	160

PORTER-CABLE		List	Sale
696	H.D. Shaper Table	150	105
695	H.D. 1 1/2 hp Router/Shaper	278	190
399	Drywall Cut-Off Unit	100	70
736	V/Speed Speedronic Band Saw	450	330
7564	1/2" X.H.D. Drill 8 amp	205	145

BOSCH TOOLS		List	Sale
1581VS	Top Handle Jig Saw	225	126
1582VS	Barrel Grip Jig Saw	126	118
1604	1 3/4 H.P. Router	199	118
1942	Heat Gun 650°-900°	99	85
1272	3x24" Belt Sander	259	159
1272D	3x24" Belt Sander w/bag	274	169
1273	4x24" Belt Sander	274	169
1273D	4x24" Belt Sander w/bag	289	179

DELTA		List	Sale
34-010	Motorized Mitre-Box	231	149

★ NEW LOW PRICES ★ PONY CLAMP FIXTURES		List	Sale
#50	for 3/4" Black Pipe	11.23	7.15
#52	for 1/2" Black Pipe	9.36	6.10

JORGENSEN HAND SCREWS	
-----------------------	--

DO IT YOURSELF Take any

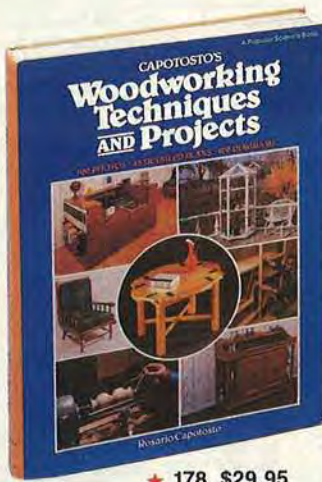

★ 178. \$29.95

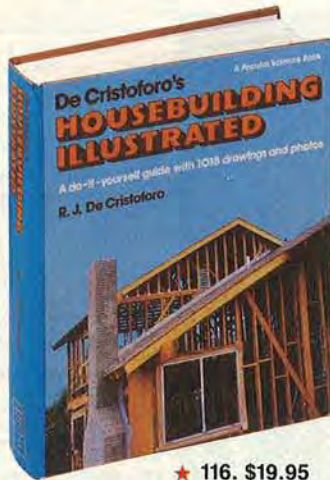

★ 116. \$19.95

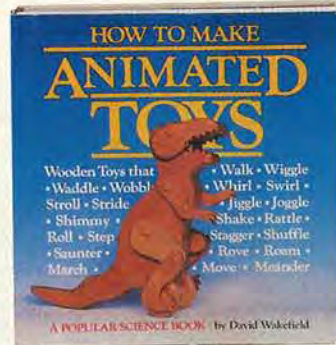

4538. \$29.95
(counts as 2)

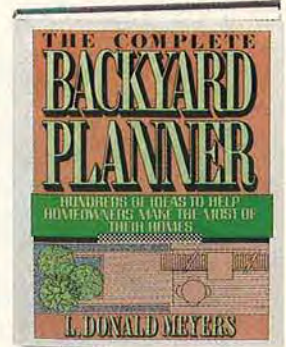

6056. \$17.50

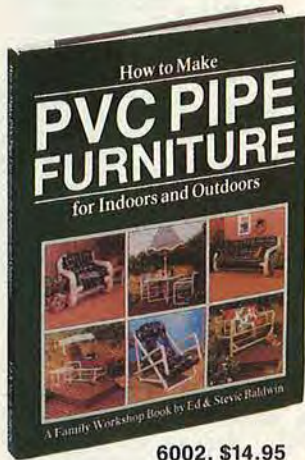

6002. \$14.95

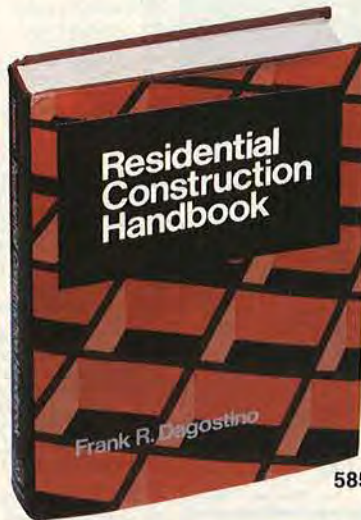

5858. \$39.95

40 books to choose from!

POPULAR SCIENCE BOOK CLUB #1 FOR DO-IT-YOURSELF

The Best How-To Authority . . . PSBC is the largest and oldest special-interest book club serving successful do-it-yourselfers more than 25 years.

The Best Do-It-Yourself Books . . . PSBC editors comb the country searching for the finest, often hard-to-find books on today's important homeowner topics:

WOODWORKING • HOME REPAIR & IMPROVEMENT • WIRING, PLUMBING, HEATING, AIR CONDITIONING • APPLIANCE REPAIR • RESIDENTIAL CARPENTRY • REMODELING • WIRING • HOUSE BUILDING • ENERGY • METALWORKING • AUTO REPAIR • much more!

Exclusive "Popular Science Books" . . . PSBC serves its members best by commissioning the top how-to writers to produce definitive books on important Club subjects. See titles with ★. These are cream-of-the-crop handy-man books available nowhere else at Club discount.

Big Bargains — UP TO 75% DISCOUNT . . . PSBC saves you plenty on hundreds of special book bargains offered throughout the year to the membership.

Quality Production Standards . . . PSBC selections are printed with careful attention to detail on paper, printing, binding. You'll use these books for years.

NO-RISK GUARANTEE . . . PSBC guarantees your complete satisfaction — or you may return your joining books at our expense.



★ 4569. \$14.95
Paperbound



6036. \$18.95



3 SKILL BOOKS—Count as 1

★ 1841. \$26.85

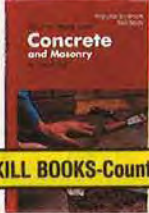

★ 176. \$24.95

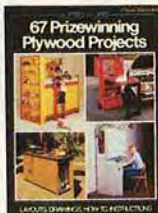

4501. \$27.95
(counts as 2)



3 SKILL BOOKS—Count as 1

★ 1208. \$17.85 Paperbound



★ 89. \$19.95

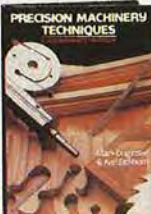

6075. \$16.95

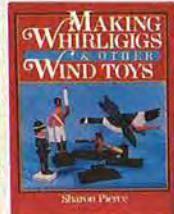

6027. \$14.95



5882. \$19.95



5831. \$19.95



★ 109. \$15.00



5944. \$16.95



★ 42. \$17.95

If card is missing, write to: **POPULAR SCIENCE BOOK CLUB • P.O. Box 2006, Latham, N.Y. 12111**

AND DO IT RIGHT!

3 for \$3.95 just \$3.95

and save up to \$91.90!

with NO-RISK Free Trial membership in Popular Science Book Club

You simply agree to buy just two more books in a year.

FREE when you join



The BENCHTOP REFERENCE gives you instant answers to hundreds of do-it-yourself questions on Woodworking, Joinery, Dowels, Veneers, Laminates, Fastening, Sharpening, Grinding, Concrete, Electrical work, more! 48 big 8x10 3/4 pages. All illustrated! Super handy and indispensable!

HOW POPULAR SCIENCE BOOK CLUB WORKS

ENJOY SAVINGS UP TO \$91.90 NOW . . . when you take any 3 selections here for just \$3.95 plus delivery and handling. Simply indicate your choices on the attached postage-free card and mail.

CLUB MEMBERS' BULLETINS . . . Fifteen times a year you'll receive a Club Member's Bulletin package describing the coming Main Selection and nearly 100 additional books you may choose from. In addition, up to 4 times a year, you may receive selected mailings on seasonal and annual products of interest to members. If you want the Main Selection only, do nothing; it will be sent to you automatically. If you want another book—or no book—indicate your wishes on the form provided and return by date shown. You will always have at least 10 days to do this. Should the bulletin arrive late and you receive an unwanted selection, you may return it at our expense.

UP TO 75% DISCOUNTS . . . Club prices range from \$5.99 for special book bargains offered at super savings up to 75% and even more . . . all the way to richly-produced, very special books that list as high as \$50 and more—all offered to members at exclusive Club discounts.

FREE GIFT with cancellation privilege . . . You may cancel your membership at any time after buying just two more selections of your choice within a year. To try this no-risk, no-obligation-to-buy offer, mail the attached card—a valuable FREE GIFT is yours to keep just for looking. Mail the card now!



5878. \$21.95

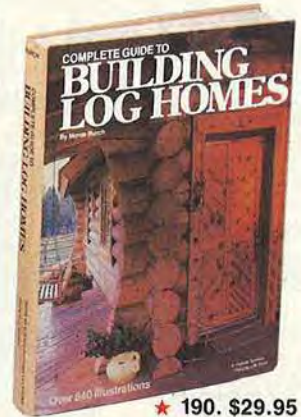

★ 190. \$29.95 (counts as 2)

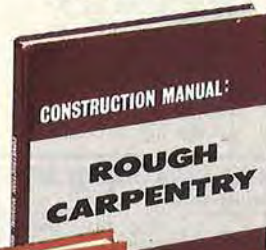

5673. \$19.95

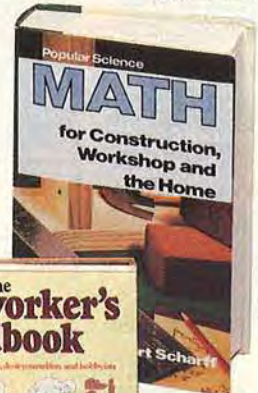

★ 160. \$25.95

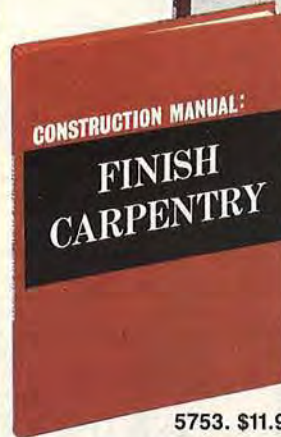

5753. \$11.95



★ 5973. \$27.95 (counts as 2)



★ 97. \$19.95



★ 105. \$17.95



★ 1886. \$17.85 Paperbound



3 SKILL BOOKS—Count as 1

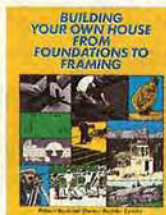

6033. \$27.95 (counts as 2)

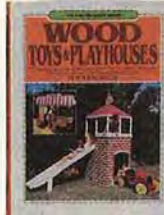

6023. \$16.95



3 SKILL BOOKS—Count as 1

★ 1745. \$17.85 Paperbound



★ 113. \$15.95



233. \$16.95



5985. \$17.95



5739. \$17.95



5993. \$17.95



5997. \$19.50 Paperbound

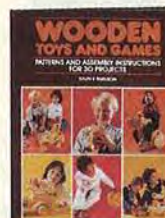

6022. \$16.95



5984. \$29.95 (counts as 2)

◀ MAIL ATTACHED CARD TODAY!

TOOL CITY

CALL TOLL FREE

INSIDE 1-800-826-7819

OUTSIDE 1-800-423-7899

• BEATS ANY AD PRICE THIS ISSUE!

PHONE NOW AND SAVE UP TO 60% ON:

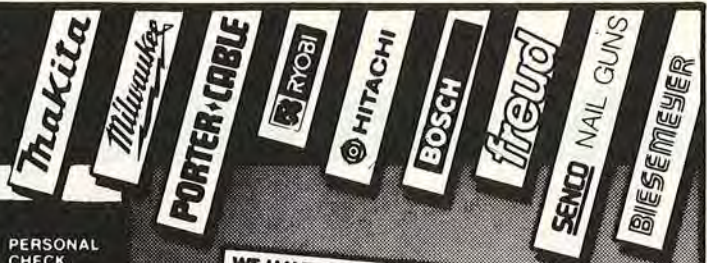

WE HAVE EVERY TOOL YOU NEED

14136 E. FIRESTONE BLVD.
SANTA FE SPRINGS, CA. 90670

MasterCard VISA PERSONAL CHECK

(213) 802-1236 OPEN MON - SAT
8 AM - 5:30 PM

*CALL FOR DISCOUNT FREIGHT
RATES FOB SANTA FE SPRINGS

FREIGHT PREPAID (USA) ON ORDERS OF \$50 OR MORE • FREE CATALOG UPON REQUEST WITH \$50 PURCHASE



FREUD TOOLS SETS WITH CASE
CHISEL SETS
MDL REG SALE
6 pc WC106 43.90 **26.95**
10 pc WC110 73.60
TURNING SET 46.95
8 pc TT108 74.70 **46.95**
CARVING SETS
6 pc CS106 82.40
12 pc CS112 153.90 **98.95**
ROSEWOOD MALLET
MALLET 24.95 **14.95**



FREUD CARBIDE ROUTER BIT SETS
with wooden case
90-100 List Sale
15pc set 299.00 **129.00**



CABINET MAKERS FREUD CABINET ROUTER BIT SET
1 Door Lip 1 Reversible Glue Joint
1 Roused Panel 2 Reversible Stile & Rail
LIST \$342.00
94-100 SALE PRICE **\$159.00**



FORSTNER BIT SET
REG \$249.00
SALE **\$159.00**

NEW MODELS PLUNGE ROUTERS.

Both models include FREE accessories \$39 Value!
HP MODEL# LIST SALE
1 HP R151 \$169 **\$98.75**
3 HP R501 \$279 **\$168.75**



MODEL AP10 10" PLANER
13 amps. power feed
LIST \$669
SALE PRICE **\$345.**
Set of Extra Blades \$29.95

FREUD SAW BLADE SPECIALS

FREUD CARBIDE-TIPPED SAW BLADES
10" x 1/2" Bore

No.	size	teeth	use	list	sale
1U72m10	10	40	general	\$68.58	34.50
1U73m10	10	60	cut-off	79.65	34.00
1U82m10	10	60	cut-off	86.40	42.00
1U84m10	10	50	comb.	74.51	\$34.00
1U85m10	10	80	cut-off	110.84	\$55.00
1M72m10	10	24	ripping	68.58	34.00

ALL OTHER FREUD SAW BLADES
PHONE FOR SALES PRICES

FREUD CARBIDE DADO'S

6	-	Dado	139.00	\$69.00	
8	-	Dado	179.00	99.00	
8	Adj.	Dado	93.00	44.00	



MODEL S 500 A 1/8" Sheet PAD SANDER
15 AMP 12000 rpm
LIST \$79
SALE PRICE **\$29.95**

BIESEMEYER BIESEMEYER RIP FENCES

28" Homeshop 195.00 52" Commercial 285.00
40" Homeshop 199.00 62" Commercial 329.00
62" Homeshop 238.00 98" Commercial 399.00
CALL FOR OTHER BIESEMEYER PRODUCTS
Protect Saw Fence 389.00

PORTER-CABLE Limited Edition "American Classic" Router NEW!
This solid die-cast aluminum housed 3/4HP anniversary issue router honors the tradition of excellence found in all Porter-Cable tools.
SALE **LIMITED SUPPLY \$119.**

Model 6010SDW 3/8" Cordless Drill, Reversible Screwdriver
LIST \$84. SALE **\$44.95**
AFTER \$5 REBATE- **\$39.95**

RYOBI MITER SAWS #1 Worldwide

TS251V accessory kit-\$20
TS 380 accessory kit-\$33
BLADE SIZE MODEL# LIST SALE
10" TS251V \$329 **\$158.95**
14" TS380 \$599 **\$319.95**

Erymac PORTABLE AIR COMPRESSOR
1 hp, 5.3 displacement, 145 psi, 2.5 gallons, 55 lbs. • E1500D \$319.

HITACHI 1/2" TR-12 Super Duty
• Fast, Clean Cuts Enabled by Powerful Built-in Motor
• Quick Change of Cutting Depth
• Three Stages of Cutting Depth Easily Selectable
• Round Base for Easy Routing in any Direction
• All Ball Bearing Construction
LIST \$299.00 YOUR PRICE **\$162.50**

MAKITA Cordless Driver Drill w/ Steel Case 2 speed reversible, 1 hour fast charge, screw, drill, polish, buff.
6012 HDW was \$178 sale **\$95.**
WE HAVE EVERY TOOL YOU NEED

Tilting Arbor Table Saw
10" - 12" Contractor's Table Saw
• cast iron extensions and top
• steel stand included
• 2 HP ball bearing motor
• jet-lock type rip fence
Reg ~~495.00~~
* Sale **349.00 complete**

DOWL-IT SELF CENTERING DOWELING JIG
*1000 \$24.95
*2000 with adapters \$32.50

RECORD Woodworker's Vice
The standard in woodworker's vices with quick release, and on the two smaller vices an integral front dog
11" jaw x 8" opening **\$68.95**
9" jaw x 13" opening **\$92.00**
10 1/2" jaw x 15" opening **\$98.00**

LEIGH DOVETAIL JIGS
TD514 12" THROUGH **\$125.**
TD514C 24" THROUGH **\$195.**
D1258-12 12 1/2" BLIND & THROUGH **\$245.**
D1258-24 24 1/2" BLIND & THROUGH **\$269.**

PORTER-CABLE MORTISE & TENON JIG
REG \$28.00
SALE **\$33.99**

26 pc SANDING DRUM KIT WITH CASE, 5 DRUM SIZES.
LIST \$49.95
SPECIAL **\$18.95**

HEAVY DUTY DUST COLLECTORS
DC101 2 HP 2 BAGS **\$299***
DC102 4 BAGS **\$499***

SPINDAL SHAPERS
1/2" SPINDAL 1 HP **\$209***
1" SPINDAL 3 HP WITH FREE 3/4" SPINDAL **\$1049***

BANDSAW SPECIAL
14" BANDSAW 3/4 HP **\$199***
18" BANDSAW 2 HP **\$549***
20" BANDSAW 3 HP **\$2195***

FLOOR MODEL DRILL PRESS
16 speeds, 3/4 hp, 5/8" chuck, table cranks up, spins, turns, & tilts.
Built in light. **\$169***

WOODWORKER'S PLANER
15" PLANER 3 HP **\$639***
20" PLANER 3 HP **\$1795***

WE SHIP IT FAST



*CALL FOR DISCOUNT FREIGHT RATES FOB SANTA FE SPRINGS SHIPPED SAME DAY UPS

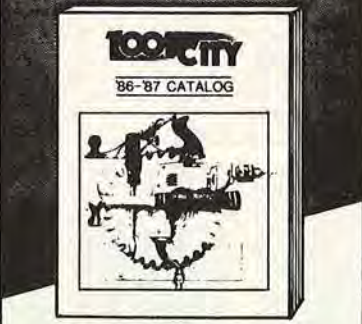

TOOL CITY CATALOG
400 PAGES! \$2.50
or free with order over \$50

TIPS FROM YOUR SHOP (AND OURS)

Continued from page 12

ON THE LEVEL

Do your tables and benches have the wobbles? Corrective leveling hardware can be expensive and sometimes hard to find.

TIP: Save money by making your own leveling hardware from T-nuts, carriage bolts, and nuts. Drill the holes for the T-nut deep enough to accept half or more of the carriage bolt, as shown below. After leveling the table, tighten the nut to lock the bolt in place.

— Stephen Cabiroy, Ballston Spa, N.Y.

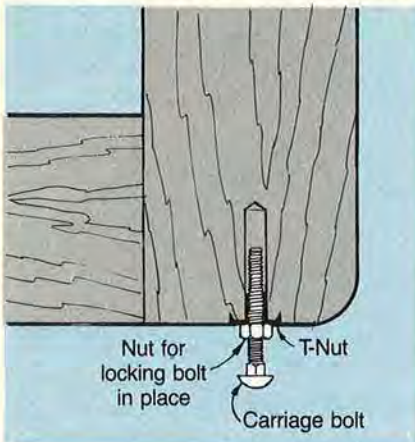

DRILL-BIT MAINTENANCE

After several uses, large-diameter bits often slip around in the drill chuck and create burrs on the bit shaft. Large burrs may prevent the bit from fitting squarely in the chuck.

TIP: A mill-bastard file quickly removes the burrs. Support the bit on a flat surface with part of the shaft overhanging the edge, as shown below. Slowly rotate the bit as you file. The same technique also restores damaged router bits.

— From the WOOD shop

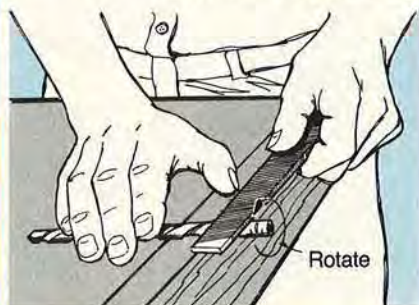

Continued

THE SOURCE



\$99

JSE-60
Electronic Var. Spd.
Jig Saw



16 1/4\" data-bbox="540 40 560 50"/>
14 1/4\" data-bbox="600 80 620 90"/>

AP-10
10\" data-bbox="540 130 560 140"/> Portable Planer
Delivered

BOTH for \$429 \$359



\$49.95

80101R
Cordless Drill



\$72-

TR-30U
Trim Router



\$179-

TS-251U
Miter Saw
with X2300
Accessory Kit

**With AMANA 80 ATB BLADE \$215-
VIRUTEX 0-81
JOINING MACHINE \$279-**



**SPLINES
5m-Md-Lg
1,000 per CTN.
\$27.50**

*Send \$3.00 for the most COMPLETE catalog of
fine hand tools & cabinet makers supplies !!!!!*

WE BEAT ANY PRICE THIS ISSUE !

US 800-452-9999 VA 800-468-1778
7305 BOUDINOT DRIVE
SPRINGFIELD, VIRGINIA 22150

FACTORY DIRECT GRANDFATHER CLOCKS



Do-It-Yourself Clock Kits

Prices Starting **\$300**
Under

(including movement and dial)

OR

**Completely Assembled
and Finished**

- Solid 3/4" hardwoods: black walnut, cherry, oak
- Heirloom quality
- Solid brass West German chiming movements and dials
- Easy to assemble kits or completely assembled and finished
- Money back guarantee

**SEND \$1 FOR
32-PAGE FULL
COLOR CATALOG**



EMPEROR CLOCK COMPANY

WORLD'S LARGEST MANUFACTURER
OF GRANDFATHER CLOCKS
Dept. 2205, Emperor Industrial Park
Fairhope, Alabama 36532 • Phone 1-205-928-2316

I am interested in Do-It-Yourself Kits
 Finished Clocks

Name _____

Street _____

City _____

State _____ Zip _____

(please print)

MYTH: If it's cast iron it's good

TRUTH: You don't buy accuracy by the pound

PRECISION WOODWORKING MACHINES



**Rex 2000
JOINTER/PLANER—**



LATHE—DB-6



SHAPER—TF-65



BANDSAW—BS-3

Austrian Built
Old-World
Craftsmanship

Emco precision machines are ruggedly built to retain the accuracies demanded by craftsmen. Ask for a free catalog on the machine for your needs.

Call: 1-800-521-8289
(In Ohio: 614-445-8382)

emco★USA

2080 Fairwood Ave.
P.O. Box 07795
Columbus OH 43207

Whirligigs Wind Mobiles Planter Pets!

Full Size Woodworking
Patterns by
Timber Technics™

These woodworking patterns are ready to trace and easy to build with detailed assembly views and instructions. Give your project that extra "character" found in each Timber Technics™ pattern. The **Whirligigs** and **Wind Mobiles** are printed in **two** convenient sizes on each pattern while the **Planter Pets™** show **three** sizes on each pattern. All patterns are printed full size on two or more 22" x 32" pages.

The **Whirligig** has a propeller "wing or leg" which turns in the wind. The **Wind Mobil** is balanced from the wings with fishline and will gently "fly" in a breeze, near an open window, or from a gentle pull on the string. The **Planter Pets™** are a wonderful way to show off your favorite flowers, vegetables, ferns and other potted plants. And, these little pets are at home inside or out!

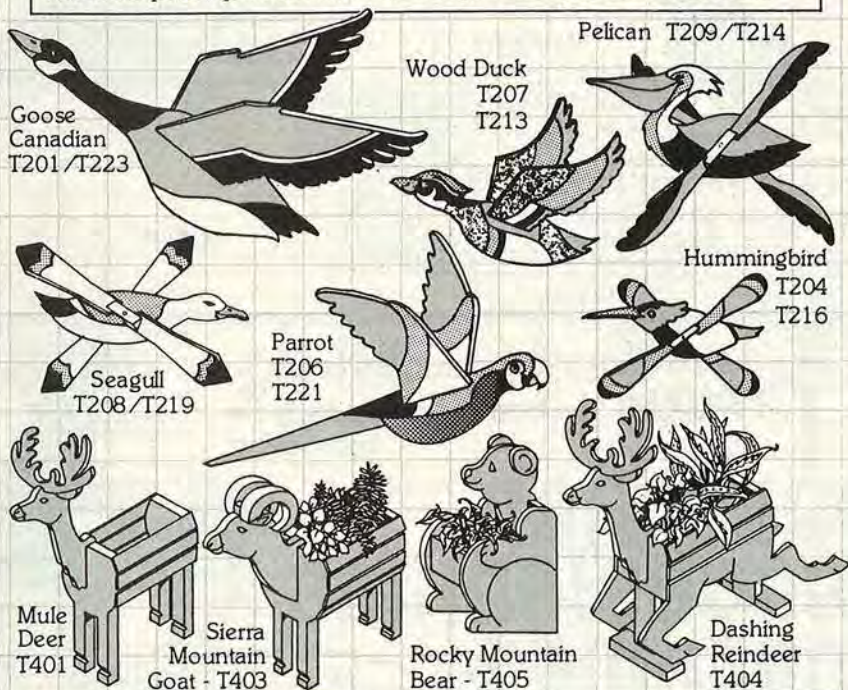

Circle items of your choice:	Price / Ea.	Total
Whirligigs: T201, T204, T206, T207, T208, T209	\$2.98 ea.	
Wind Mobiles: T213, T214, T216, T221, T219, T223	\$2.98 ea.	
Planter Pets: T401, T403, T404, T405,	\$3.49 ea.	

Timbers Catalog with hundreds of Woodworking Patterns & Supplies is included FREE with any order. \$1 alone.	Sub-Total	
	Calif. Residents add 6% Sales Tax	
	\$2 Processing Fee Per Order	\$2.00
	Total enclosed US funds (Canadians add 30%)	

For VISA and Mastercard orders call 24 hr. 916/581-4141

NAME: _____
 ADDRESS: _____
 CITY: _____
 STATE: _____ Zip _____
 Phone: () _____

Timbers/Lake
Tahoe, Inc.
2911 Lake Forest Rd.
Dept. T1
Carnelian Bay, CA
95711-0850



TIPS FROM YOUR SHOP (AND OURS)

Continued from page 19

PASSING GRADE ON THIS REPORT

Exposed handsaw blades are a triple threat: They injure careless bands, they inadvertently mar wood, and they damage easily.

TIP: Although blade guards are available at most hardware stores, there is a cheaper alternative.

The plastic spines from business-report covers (sold at office-supply stores) perform the same task as blade guards.

— Carl Dorsch, Oakdale, Pa.

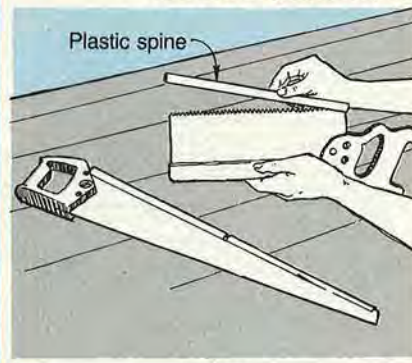

CENTER ISSUE

It's difficult to locate the center of cylinder turning stock and other circles with only a straight-edge and pencil.

TIP: An inexpensive, simple jig quickly and accurately pinpoints the center of a circle. Cut a 90° notch from 3/4" stock. Screw a straightedge over the notched base, as shown, to create a 45° angle. Place the circle against the guide and scribe one line. Rotate the circle about 60° and mark another line. To check the accuracy rotate the circle once more. If the lines form a small triangle, the center is inside the triangle.

— George Kaarenberg, Chincoteague, Va.

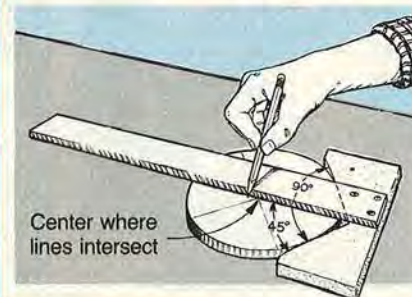

NYLON-SMOOTH FINISH

Polyurethane makes a great finish for many projects, but cleaning brushes after use often takes longer than applying the finish. And with quick drying products, brush marks can also be a problem.

TIP: Ask someone to save you a few pairs of discarded panty hose or nylon stockings. Cut the hose into 6"-long strips and use the wadded strips to apply the finish. Dispose of the strip after use. No brushes to clean and you get a "nylon-smooth" finish with no streaks or brush marks.

— From the **WOOD** shop

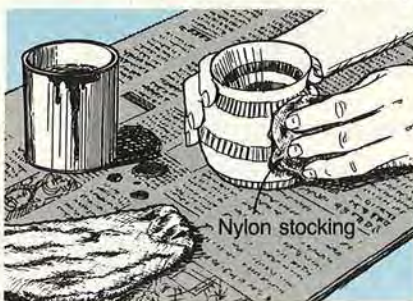

Nylon stocking

FELT BAD ABOUT MARRING?

Oops! You've just pulled another nail from a piece of wood and remembered, too late, how easily a hammerhead dents the wood surface.

TIP: Glue a piece of felt or apply adhesive-backed felt to the top of the hammer. It's dependable and much easier than searching for a scrap of wood when removing nails. 🐿

— Al Bruder, Chicago, Ill.



Felt

Timbers' Woodproject™ Directory



Guide To 768 Woodworking Projects PLUS FREE Binder Only \$19⁹⁵



Timber's Woodproject Directory is a series of woodworkers' guides that tell you where to find the patterns for 768 projects. Everything can be made in your own workshop. Each guide lists and illustrates 64 projects!

The Directory tells you how to get more than 250 project photocopies **FREE!**

FOR EXAMPLE: Perhaps you would like to build a desk for your den. In guide #3-Desks, one of the 64 projects listed is a "Oak Raised Panel Library Table," Wood Magazine, June 1985, pg. 50. The Guide tells you how to get this project photocopy absolutely **FREE!**

Order all 12 guides (listing 768 projects) for only \$19⁹⁵ and you will receive Timbers' Woodproject Directory Binder **FREE** (an \$8⁹⁵ value). This special offer saves you nearly \$16.00!

Sample Offer

Our Sample Offer to Wood Magazine readers: any two guides for **ONLY \$2²⁵**. Simply write your choices in the boxes on the order form. Additional guides are \$2²⁵ each.

See **FREE Binder Offer**

Timbers Catalog, **FREE** with order. \$1 alone

Timbers Woodproject Directory All 12 Guides & FREE Binder	\$19.95	TOTAL
SAMPLE OFFER Any TWO Guides for \$2.25 Write desired Guide #'s in boxes <input type="checkbox"/> <input type="checkbox"/>	\$2.25	
CIRCLE ADDITIONAL GUIDE ORDER #'S OF YOUR CHOICE 11, 12, 13, 14, 15, 16, 17, 18, 19, 20, 21, 22	\$2.25 each	
CA residents add 6% sales tax		
Mail order processing fee		\$2.00
TOTAL INCLUDED		

Mastercard / VISA orders, please include card # & expiration date. Telephone order 24 hrs / day 916-581-4141.

Name _____

Address _____

City _____

State _____ Zip _____

Phone _____

- Guide Order #'s**
- Curio Tables, End Tables, and Dining Room Tables
 - Wooden Toys and Children's Furniture
 - Desks - Slant Top, Roll Top, etc.
 - Whirligigs, Yard Furniture, Planters and Outdoor Projects
 - Gifts - Trinkets & Music Boxes, Brooches, etc.
 - Kitchen Projects - Wine & Spice Racks, etc.
 - Shelves and Wall Hangings
 - Cabinets and Cupboards
 - Chests and Bedroom Furniture
 - Chairs, Benches and Household Furniture
 - Lamps, Stools and Household Furniture
 - Homemade Tools, Workbenches and Jigs

**Timbers/
Lake Tahoe, Inc.**
2911 Lake Forest Rd.
Dept. T10
Carnelian Bay CA 95711-0850

POWERMATIC



Call For Our Low Prices! We carry the entire Powermatic line at very attractive prices. Please call for our prices on the Model 66 and other Powermatic machines. You'll be glad you did!

Model 66 Table Saw with 50" Biesemeyer Rip Fence, 3HP, 1PH or 5HP, 3PH motor

MINI MAX . . .

We believe the MiniMax Elite Craftsman Series is simply the best line of new machinery to be offered to the U.S. woodworker in years. Please call or write for more information on any of these fine tools.

FS35 13 1/2" Jointer-Planer	\$2195
C30 Combination Machine	\$2995
S45 18" Bandsaw	\$1099
Pro 32 12 1/2" Bandsaw	\$ 615
T120 47" Lathe	\$ 948



AP-10
Thickness planer

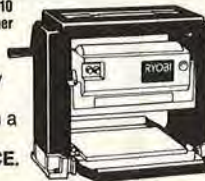

WE DIDN'T BELIEVE IT until we actually used it. This tool works really well — as well as any planer we've used, except on a smaller scale. 10" width of cut, 13 amp. motor powered. **CALL FOR OUR PRICE.**

FREUD'S NEW BISCUIT JOINTER!!

Freud's new biscuit jointer allows quick, accurate assembly of cabinets, furniture and even picture frames at a fraction of the time as conventional methods. Works at 90° and 45°; includes carbide-tipped cutter and carrying case. We're introducing the JS100 at an extremely low price of \$179. Quantities are limited and this offer will expire Feb. 28, 1987.

JS100 Plate Joiner	\$179.00
JS020 1000 Biscuit	29.00
F1100 Spare Cutter	34.95



THE XYLOPHILE'S COMPANY

138 E. Loudon Ave. • Lexington, Ky. 40505

(800) 354-9083

M/C VISA

FREUD SPECIALS

WC-106	6 Pc. Chisel Set	27.00
WC-110	10 Pc. Chisel Set	47.00
TT-108	8 Pc. Turning Tool Set	47.00
90-100	15 Pc. Router Bit Set	134.00
92-100	26 Pc. Router Bit Set	284.00
94-100	5 Pc. Router Cabinet Set	179.00
FB-100	16 Pc. Forstner Bit Set	159.00
EC-900	5 Pc. Shaper Cabinet Set	289.00
EC-209-213	Raised Panel Cutters	77.00
EC-260	3/4" Cabinet Door Set	157.00

Sawblades

LM72M	10", 24T, Rip Blade	34.00
LU73M	10", 60T, ATB Cutoff	34.00
LU84M	10", 50T, Combination	36.00
Set of Three Above		99.00
LU82M	10", 60T, Triple Chip	42.00
LU85M	10", 80T, Super Blade	59.00
DS306	6" Dado	90.00
DS308	8" Dado	99.00

We carry the entire line of Freud shaper cutters and router bits at discounts up to 30%. Please call for prices on these items.

Freud Orders over \$35 are prepaid.

THE WOODWORKING SHOW

machinery— tools— supplies

Widest Variety of Woodworking Products Under One Roof

So. California
Colorado
Atlanta
Florida
St. Louis

Seminars by James Krenov — Ian Kirby — Michael Dunbar — Rude Osolnik
Dale Nish — Roger Cliffe — Bob Rosendahl — and other Master Craftsmen

- Jan. 30—Feb. 2
- Feb. 13—14—15
- Mar. 13—14—15
- Mar. 20—21—22
- Mar. 27—28—29

- Long Beach Conv. Ctr.
- Nat'l Western Complex
- Atlanta Civic Center
- Florida State Fair, Tampa
- Chase Park Plaza Hotel

1-800-826-8257, In Calif. 213-477-8521
Call for free brochure, 8:30—5 Pacific Time

16 SPECIAL SHOWS
IN 1987!

- Free Workshops
- 100 Exhibits
- Door Prizes

Bring ad and save \$1 OFF
regular admission
price of \$5.

NOW A SURFACE/THICKNESS SANDER AT A NEVER BEFORE PRICE

\$179.95



Vacuum Dust Collector
Cut-Away View

The **PERFORMAX SANDER** attachment clamps onto your radial arm saw column instantly. Powered by the saw motor and with the drum height controlled by the saw adjustment mechanism, this space saving attachment will make a useful, inexpensive addition to your woodworking tools.

- A open end design allows you to sand boards from 1" to 44" wide.
- A new slide fastener eliminates the need for special paper adhesives and makes changing papers a snap!
- You will be able to finish sand to uniform thickness with remarkable speed.
- Makes edge sanding for parallel edge jointing easy.
- Your **PERFORMAX SANDER** requires minimum storage space when not in use.
- Moneyback Guarantee

For additional Information Write:

PERFORMAX PRODUCTS

17065 Judicial Rd., Dept. W27 Lakeville, MN 55044

or call **TOLL FREE**

•1-800-328-5727 Ext. 114 •1-800-742-5685 Ext. 114 (In MN)

"Jorgensen" AND "Pony" CLAMPS

Dependable extra hands for all types of clamping and work-holding jobs: woodworking projects, home maintenance, and furniture repair.

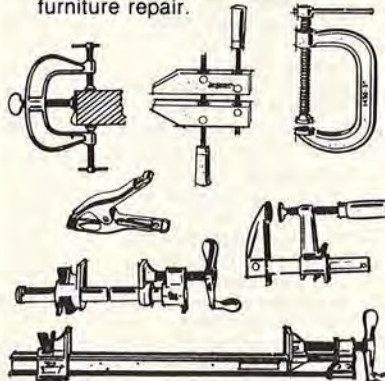

Write for **FREE LITERATURE**. For big 32-page "how-to-clamp-it" catalog, send \$1.00.

ASK YOUR DEALER

ADJUSTABLE CLAMP COMPANY

THE CLAMP FOLKS
410 N. Ashland Ave./Chicago, IL 60622

ANDREOU

INTRODUCING

MiniMax

A Division of e scm

ALL MODELS AVAILABLE!

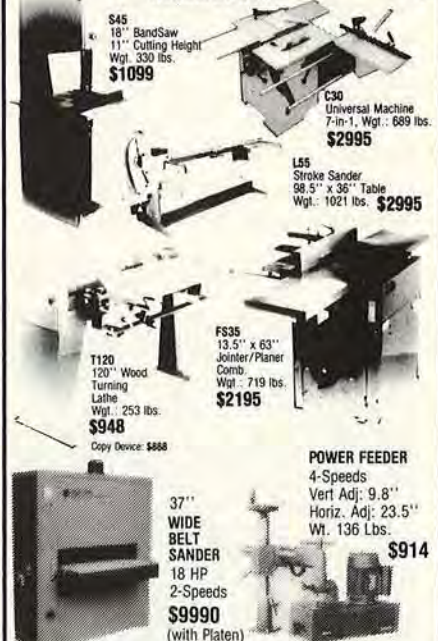

S45 18" Bandsaw
11" Cutting Height
Wgt. 330 lbs.
\$1099

C30 Universal Machine
7-in-1, Wgt. 689 lbs.
\$2995

L55 Stroke Sander
98.5" x 36" Table
Wgt. 1021 lbs. **\$2995**

T120 120" Wood
Turning Lathe
Wgt. 253 lbs.
\$948

FS35 13.5" x 63"
Jointer/Planer
Comb.
Wgt. 719 lbs.
\$2195

POWER FEEDER
4-Speeds
Vert Adj. 9.8"
Horiz. Adj. 23.5"
Wt. 136 Lbs. **\$914**

37" WIDE BELT SANDER
18 HP
2-Speeds
\$9990
(with Platen)

VISIT OUR SHOWROOM

ANDREOU INDUSTRIES, INC.

22-69 23rd STREET ASTORIA, NEW YORK 11105

(718) 278-9528

M/C VISA

24 HOURS /
7 DAYS A WEEK



MESQUITE: the desert do-it-all

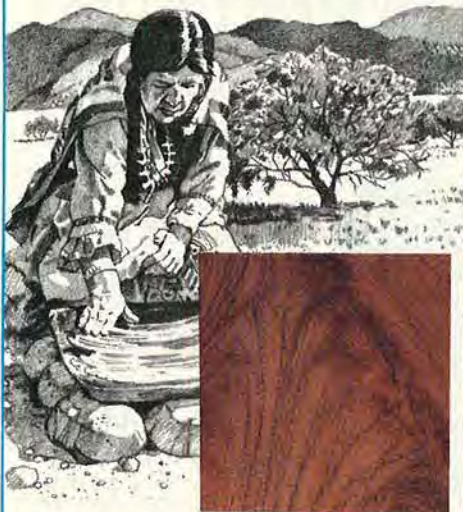

Mesquite, now prized as a fuel, feeds animals and man, and provides beautiful woodworking stock.

Desert survival requires extreme measures. The shrub-like mesquite tree, for instance, thrives in desert country from Argentina north to the southwestern United States by searching for water with an extensive lateral root system. It also sends taproots far into the earth. In fact, mesquite roots have been discovered 174' below ground in a copper mine!

Not only do mesquite's meandering roots stem erosion of the desert's fragile soil, they also enrich it with nitrogen. But mesquite's role doesn't end there.

When the desert blooms, this small tree's flowers yield nectar for a delectable honey. Later, when the sun scorches other plants, its seed pods feed wild animals, livestock, and man. For example, Arizona's Pima Indians grind mesquite pods into a flour for tortillas and brew them into a pseudo-beer.

Mesquite's major use, however, is for fuel. The wood has a high BTU value, burns with little smoke, and produces minimal ash. Because of the wood's slow-burning characteristic and the unique flavor it imparts to meat cooked over its coals, mesquite charcoal briquets have become the rage for outdoor barbecues. Some fashionable city restaurants are now billing their fare as "mesquite grilled."

Knowing woodworkers seek out mesquite where it grows to tree-size because it shrinks less than three percent from green to bone-dry, works as easily as walnut, bends without steaming, resists wear, and has a color that grows more beautiful with age. Turnings, furniture, and parquet flooring made from this desert do-it-all prove quite notable. 🌳

Photograph: Hopkins Associates
Illustration: Jim Stevenson

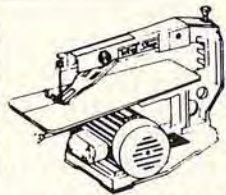

15" Scroll Saw

- Comparable to Hegner or Delta
- Fully adjustable table
- 2" depth of cut/3/4" stroke
- 110V
(Shipping and handling \$20.00)

\$199⁰⁰

Total Shop

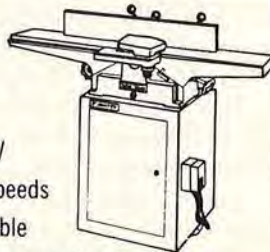

6" Heavy Duty Jointer

- 3/4HP, 110V
- Adjustable speeds
- Fully adjustable
- 190 lbs. (ships freight collect)

Reg. \$499⁰⁰ **\$299⁰⁰**



8" Industrial Quality Jointer

- 1 1/2HP, 220V
- 65" length
- 397 lbs. (ships freight collect)

Reg. \$795⁰⁰ **\$575⁰⁰**

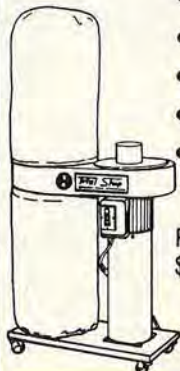

Dust Collector

- 1HP, 110V
- 4" inlet
- Industrial quality
- Compact size
(Shipping and Handling \$30.00)

Reg. \$398⁰⁰ **\$199⁰⁰**

Total Shop

Dept. Q
P.O. Box 16297/Greenville, SC 29606

Name

Address

City

State/Zip

Phone

30-Day Money Back Guarantee
1-Year Warranty

Call or in S.C.
Toll Free 1-800-845-9356 288-4174

TOTAL AIRE Air Compressor

- 1/2HP with 3.3 cu.ft. of air per min.
- 150 PSI capacity
- Wheels and handle for easy moving
- Can be used with air tools for spray painting, pumping tires, cleaning shop, etc.

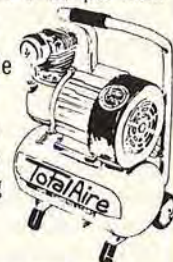

(Shipping and handling \$20.00)

Reg. \$419⁰⁰ **\$199⁰⁰**

The Lumber Company™



Now all you need is the tree.

The new portable sawmill from Delta.

Now you can make boards from your own logs (up to 23" in diameter). To your dimensions. Right where your tree is felled.

Instead of taking your tree to a sawmill, why not take your sawmill to the tree. And eliminate a lot of heavy hauling.

The Lumber Company weighs 165 pounds. It rides the log. All you do is guide it.

The narrow-kerf band saw blade produces more useable lumber, with 80% less waste than chainsaw or circular blade mills.

You can mill hundreds of board-feet of dimensioned wood in a day's time.

At that rate you can pay for your Lumber Company pretty quickly.

To find out more about The Lumber Company, or to get a video cassette demonstration, call toll-free: Delta International Machinery Corp., 800/438-2486. (In PA, 800/438-2487.)



Converts to vertical band saw for ripping. (stand optional)

DELTA
Building On Tradition

PRODUCTS THAT PERFORM



Here at WOOD, we're always looking for products that make life in the woodshop a bit easier, or make a project a bit nicer. When you find a product that really works for you, you tell your friends, right? That's the purpose of this column. We don't always feature the latest products on the market, but ones we think you, as a woodworker, will be interested in. And we test all of them to make sure they meet *our* standards of performance: we hope they'll meet your requirements, too!

Woodworker-friendly calculators

In a world of calculators that operate on the decimal system, these two speak woodworker's language — fractions.

The mechanically operated *Fractron Calculator* works like a circular slide rule; it quickly and easily adds and subtracts fractions, giving its answer to the nearest $\frac{1}{64}$ ".

To add with it, you just insert a pencil or pen point into the hole next to the first fraction in the equation, and rotate the dial clockwise until it stops. Repeat the process for each fraction you want to add. To subtract a fraction, you simply reverse the direction of rotation.

The *Construction Master* electronic pocket calculator quickly solves practically any problem involving fractional dimensions. With it, you can add, subtract, multiply, and divide, in feet, inches, and fractions (to $\frac{1}{64}$ "), as well



as in decimal values.

The *Construction Master* also does the following calculations:

- Converts displayed measurements directly to or from the following formats: feet-inch-fractions, decimal feet, inches, yards, meters.
- Instantly calculates area and volume (both square and cubic measurements).

- Calculates angles (pitch, run, rise, slope). Also calculates board feet/dollar costs.

The *Construction Master* comes with two replaceable button-cell batteries, vinyl carrying case, user's manual, and a one-year warranty. Leather case optional. *Fractron Calculator*, \$9.00 postpaid from *Graphic Systems*, P.O. Box 881, Melville, NY 11747. *Construction Master Dimensional Calculator* \$93.45 postpaid from *Calculated Industries*, 2010 N. Tustin Ave., Suite B, Orange, CA 92665.

No more waiting: This glue dries fast

You're turning a bowl on the lathe and run into a crack, loose knot, or soft area. With *Hot Stuff* instant glue and *Hot Shot* glue accelerator, you can make repairs and get back to turning within a few minutes. No more long "down times" associated with slower-drying epoxy and conventional wood glues.

A water-thin cyanoacrylate adhesive, *Hot Shot* penetrates hairline cracks, making a complete bond. Adding a squirt or two of *Hot Stuff* accelerator makes the glue set hard in less than a minute. The

firm also offers *Hot Stuff Special 'T'*, a syrup-consistency glue for filling small gaps, holes, and voids. The spray-on accelerator works with both types. *Hot Stuff Adhesive (Original) IG100*, 2 oz. bottle, \$8.95 postpaid; *Hot Stuff Special 'T' IG200*, 2 oz. bottle, \$9.75 postpaid; *Hot Shot Accelerator IG300*, 3 oz.

bottle, \$3.95 postpaid. Available from *Woodcraft Supply Corp.*, 41 Atlantic Ave., P.O. Box 4000, Woburn, MA 01888 or *Craft Supplies U.S.A.*, 1644 S. State St., Provo, UT 84601.



Continued on page 28

Save \$10,000 or more on your new home. Be your own builder.

No experience needed. Learn at home as NRI shows you how in a professional Building Construction course.

You can save from 10% to 50% of the cost of your new home by building it yourself. And NRI can show you how. NRI's professional course in Building Construction teaches you what you need to know to be a building contractor. And you learn at home in your spare time. Whether you want to build your own home, get a better job, or start your own contracting business, NRI can get you started right.

From Site Selection to Landscaping

By being your own contractor, you save at least 10% of the cost of the typical home right up front. Then, depending on how much of the job you do yourself, you can save up to 50%. NRI takes you through the job from start to finish in 70 lessons full of photos and diagrams to make learning easy. You begin by learning how to pick the best site, learn to read blueprints, estimate costs, follow the job through right to the planting of shrubbery and trees.

Learn Professional Secrets

Nothing's left out. You learn the trade practices and secrets of the pros. Masonry, carpentry, roofing, painting, even plumbing, heating and electrical work. You learn what good work looks like, tip-offs to bad or sloppy work. How to supervise jobs...when to bring in specialists...trade and financial practices...how to keep your job moving on schedule.



Training Built Around Energy-Efficient Home

You learn better because NRI training is practical training. You get over 100 action projects from scale-model construction to building actual framing sections. Lessons and projects are coordinated with a contemporary energy-efficient home designed espe-

cially for NRI. You keep these plans to build your own home or select from more than 50 low-cost optional plans.

Regional Seminar

As an exclusive service, graduates may participate in an optional owner/builder seminar. You'll get expert advice on local building codes and conditions, meet builders, learn more about energy efficiency, receive tips on financing. There'll be demonstrations, insider info on remodeling, hands-on programs to take part in.

Send for Free Color Catalog

There's much, much more to the NRI Building Construction Course. Send the postage-paid card today for your free catalog describing all lessons, projects, and opportunities in the building business. See how you can save big money by building your own home or earn big money by building for others. If card has been removed, write to address below.

Or check card for other career opportunities

Small Engine Repair

Learn to service lawn mowers, garden tractors, chain saws, tillers, outboards, mopeds, motorcycles and more. Includes professional tools like inductive tachometer, volt-ohm meter, torque wrench, valve spring and ring compressors. You work with 5 HP engine as part of your training.

Air Conditioning/Refrigeration/Heating with Solar Technology

Covers both residential and commercial fields, including lessons on solar heating, heat pumps, etc. Complete with professional tools, including top-grade vacuum pump, system analyzer, tubing and joint tools, leak detector, and more.

Electrical Appliance Servicing

NRI trains you to be a professional appliance repairman, even shows how to start your own full-or part-time business. Fix everything from toasters

to refrigerators and microwave ovens. You even get professional tools and instruments.

Auto Repair and Servicing

A qualified mechanic can work just about any place he wants. NRI trains you at home from headlight to rear bumper; pro tools included.

Locksmithing

Earn good money while you train, making keys and servicing locks for homes, offices and cars. NRI training includes keymaking machine, key blanks and electronic security training—all in one course.

NRI SCHOOLS

McGraw-Hill Continuing Education Center
3939 Wisconsin Ave.
Washington, D.C. 20016

WE'LL GIVE YOU TOMORROW.



Continued from page 24

A "fine" saw, any way you cut it



This adjustable jeweler's saw uses scroll-saw blades up to 6" in length to make the fine kerfs required for intricate projects. You can rotate the blade 360° in the saw frame to cut in any direction; twisting the wooden handle adjusts blade tension (it works like a coping saw). But use a light touch with this saw — we found that the thinner-sized blades break easily. *Adjustable jeweler's saw No. 250, Great Neck Saw Manufacturers; available nationwide through hardware stores and home centers. We paid \$8.95 retail for ours.*

Foolproof square for perfect setups



There aren't many truly revolutionary "benchmark" layout tools, especially one as accurate as this newly patented electronic precision square. But we found *Square It* amazingly simple to use for determining precise 90° and 45° angles on tools requiring these settings. With it you can square up table saws, drill presses, radial arm saws, jointers, disk sanders, hand planes, and more. To use, just place this device against the adjoining metal surfaces to be squared, such as the saw blade and table, and adjust the tool until the device's small krypton bulb lights up.

The manufacturer guarantees an accuracy of $\frac{1}{10,000}$ of an inch. But to give you a better idea of how accurate this instrument is, after using the tool to set a 45° angle on our table saw (see photo above) and the light came on, we pressed down on a corner of the saw table with one finger. This caused enough table deflection to make the light go off again!

Square It comes with an illustrated, comprehensive manual with excellent detailed instructions for squaring-up over 15 stationary machines and hand tools. We tested the prototype model, shown in the photo above. The production model, which should be available by the time you get this issue, will have a dark-colored case with obscure, translucent plastic sides (not transparent, as shown here), and a krypton light bulb. It takes two replaceable alkaline batteries (included). *Square-It, \$76.50 postpaid from ZAC Products Inc., 34 Renwick Street, New York, NY 10013.*

Continued on page 30

MiniMax

A Division of e scmi



Sale \$2795.00

Stroke Sander

This is a versatile machine for sanding panels and cabinets, or odd-shaped pieces. Features include a unique design which allows the table to fold up to save valuable floor space. Work table area is 100 x 37". Specify 4 HP/ three phase or 3 HP/single phase motor. 1020 lbs. #L55 List \$2995.00

13 1/2" Jointer/Planer

Planer features a large 13 1/2" wide by 7 1/4" thick capacity, spiral infeed, and 49 cuts per minute @ 23 FPM feed rate. Jointer has extra-long 63 x 14" table and 0-45° tilting fence. Includes 3 HP single or three phase motor (specify which), magnetic starter, guards, tool set and 3-knife cutterhead. 719 lbs. #FS35 List \$2195.00.

Sale \$1995.00

#FS35B As above with optional 5/8" chuck and mortise table. List \$2395.00.

Sale \$2195.00

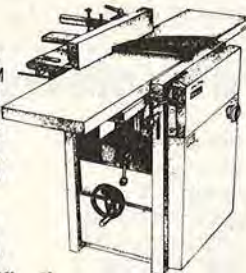

Call for complete specifications

FREE freight on all machines except UNO and L55 sanders

Order No.	Description	List	SALE
PR32	12 1/2" band saw	\$615	\$575
S45	18" band saw	\$1099	\$995
C22	Universal machine	\$2495	\$2295
C30	Universal machine	\$2995	\$2795
T3	3/4" or 1" spindle shaper	\$1699	\$1575
T120	47" lathe	\$948	\$875
T120	Copy attachment	\$868	\$795
UNO	37" wide belt sander	\$9990	\$9495

Send \$2.00 for a copy of our New Woodworking Catalog

Refundable with first order

See us at the WANA Woodworking World Washington DC Show Feb. 27 - March 1

MAKE BEAUTIFUL RAISED PANEL DOORS . . . WITH YOUR ROUTER!

Professional production quality bit makes it quick and easy to produce matching rails and stiles — the panel raising bit with ball bearing guide makes the raised panel perfect every time.

Regular value over \$180.00

SALE PRICE **\$79.95** FOR COMPLETE SET

ORDER ITEM #154 (Includes all bits shown)

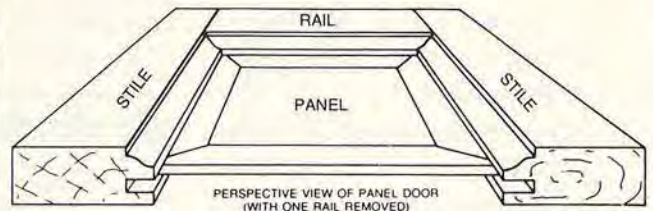

RAISED PANEL BIT
SUPPLIED WITH BALL BEARING CARBIDE TIPPED
3-1/4" Large Diameter

1/2" Shank



REVERSIBLE COMBINATION RAIL and STILE BIT

(For making matching rails and stiles in raised panel doors, etc.)
Works with stock from 1 1/16" to 7/8" thick



CARBIDE TIPPED — TWO FLUTE
1/2" SHANK
supplied with Ball Bearing

To order by Master Charge or Visa Toll Free

7 Day — 24 Hour Order Service, Call

1-800-523-2445, Ext. 56 (in PA 1-800-346-7511, Ext. 56)

or send check to MLCS, Ltd., P.O. Box 53D, Rydal, PA 19046

w.s. JENKS & Son



1933 Montana Ave. NE
Washington DC 20002
(202) 529-6020

1-800-638-6405

BUILD THE BEAUTIFUL BLUENOSE II

It's A Relaxing Hobby

In today's hurried, harried world, everyone needs a relaxing hobby. Model ship building – the world's oldest hobby – is the surest way to wind down and enjoy a creative outlet. You need no special skills. Just some spare time, patience and a desire to build something worthwhile. As you see your ship model approaching completion, you'll take pride in your creative efforts and newly acquired knowledge of how great sailing ships were built.

Become A Shipwright of Old

Even if you've never built a model before, you can build the Bluenose II. Like a shipwright of old, you'll build this schooner the way real ships were built – using only the finest materials. You'll plank the hull twice; first with Oregon pine, and then with walnut for lasting beauty. Most wooden parts, including keel section and frames, are pre-cut for easy assembly.



Anchor chains, eye-bolts, and belaying pins are all made of brass. Even the rudder hinges are brass, just like the hundreds of pin nails you'll use to fasten the planking. You'll get cotton rigging to hoist the sails. Thin white Mukali wood strips to plank the deck. Beautiful, pre-printed cloth sails. Blocks and deadeyes of walnut and boxwood. And a wooden pedestal to proudly display your finished model.

Of course, nothing this beautiful and well detailed can be built in a day. Expect to spend 50 to 100 hours building this magnificent schooner. Hours of enjoyment and immense satisfaction. Our clear instruction booklet and giant plans make every stage of construction simple.

You'd expect to pay over \$100 for such a high quality kit. But to introduce you to ship modeling, we're offering it at the special low price of \$69.95. A small price to pay for a finished model which should be worth many times the cost of the kit.

A Link with the Past

Built in 1963, the Bluenose II is the last of the Tall Schooners. She paraded in the Tall Ships ceremony at OpSail 1976 and again sailed proudly at the Liberty Weekend OpSail on July 4, 1986. She's an exact replica of the original Bluenose, a Canadian fishing schooner that outraced New England's fastest fishing vessels in the Twenties and Thirties, landed record catches of fish, and even ran rum during Prohibition!



NEW! 64-page full-color Ship Model Catalog with details about the "Win a Trip to a Ship" Contest. FREE with order.

Model Expo, Inc.

23 Just Road, Fairfield, N.J. 07007

If not completely satisfied, return within 30 days for a full refund

Visit our stores at:

25 Just Road, Fairfield, NJ
2758 W. Sepulveda Blvd., Torrance, CA



A Treasure for the Future

Our Bluenose II is one of the finest ship model kits. Using only the highest quality materials, you'll create a wooden ship model that's an heirloom for tomorrow. A treasure that will be a source of pride for a lifetime. Or a cherished gift to be remembered by family and friends for generations to come.

A Complete Tool Set Offer

You don't need a whole workshop full of tools to build the Bluenose II – just the basics. We've put together

a tool package with all the tools you'll need! You'll get: hobby knife, mini-hammer, pliers, 2 files, ruler, 3 drill bits, 3 blades, razor saw blade, pin



vise, tweezers, sandpaper, glue, paint brush and wood oil – a \$34.95 value, but now only \$19.95 when you purchase the Bluenose II.



Order Today – Get a FREE Book!

Order your Bluenose II now and get a FREE copy of **Ship Models from Kits**, a 110 page book selling for \$7.95. This illustrated guide gives step-by-step instructions for building the perfect ship model, plus dozens of tips from the experts.

Win a Trip to a Ship or Cash

Build the Bluenose II and win a trip for two to Halifax, Nova Scotia or Vancouver, B.C. Or, you could take \$1000 cash instead! Just enter your completed model in our "Win a Trip to a Ship" Contest. Photographic entries must be post-marked by 1/1/88 and will be judged by a panel of independent ship model experts on the basis of excellence of craftsmanship and accuracy. Details about the contest and its many prizes are contained in our 1987 Ship Model Catalog included FREE with your Bluenose II kit.

Special Offer! 90-minute Videotape

Prefer to see it all on your TV. screen? Watch our new 90 minute VHS Videotape, "You Take the Helm". You'll see the Bluenose II being built by a professional model builder. And you'll learn how to build any plank-on-frame wooden ship model. Many helpful hints and secrets for building professional quality models are highlighted. You'll be an expert on your first trip out! A \$29.95 value, this videotape is now specially priced at \$19.95 when you order your Bluenose II kit.



Credit card holders may order by phone.
Call Toll-Free 800-228-5588.
24 hours a day.

©Model Expo, Inc. 1986

Model Expo, Inc. 23 Just Road, Fairfield, NJ 07007

Dept BHW-17

Yes! I want to build the Bluenose II Kit. Please send me:

My check _____ Or money order _____ is enclosed
Charge my Mastercard Visa American Express

_____ Bluenose II Kit(s) No. AL500B and my FREE beginner's handbook for only \$69.95.

Card No _____

Also send me the following at these special low prices.

Expiration Date _____

_____ 90-minute VHS Videotape "You Take the Helm"

Signature _____

_____ No. SST500 just \$19.95 (a \$29.95 value):
_____ Tool Package No. MXT100B now only \$19.95 (a \$34.95 value).

Name _____

Address _____

Please include \$7.50 for shipping and insured delivery. N.J. residents must add 6% sales tax.

City _____ State _____ Zip _____

WOODWORKER'S CATALOG

There are over 3,000 money saving reasons why woodworkers rely on Constantine.

3,000 woodwork items—to help you Build-Restore-Repair-Refinish! Over 200 different woods... 150 veneers... 500 plans... cabinet hardware... 96 How-To Books... 118 carving tools and chisels... 76 inlay designs... and lots more for One-Stop, Right-Price Shopping without leaving home!

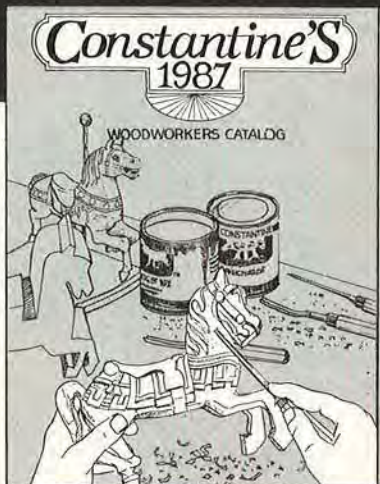

PRODUCTS THAT PERFORM

Continued from page 28

No-mess spray adhesive bonds most materials



We used this convenient, multipurpose spray adhesive to glue cork to tempered hardboard, paper to wood, fabric to wood, plastic to plastic, and plastic to wood. The manufacturer, 3M, claims

the clear-drying, high-tack adhesive will bond most porous and nonporous materials. Used as directed, it forms a strong, permanent bond between these materials. Or, use a light application for temporary bonding.

The product has an open time of 15-30 minutes. A 17 oz. can covers about 160 square feet. It's highly volatile, so use in a well-ventilated area, away from open flame. Avoid inhaling spray fumes. *3M Super 77 Spray Adhesive, available nationwide through hardware stores and home centers. We paid \$7.69 retail for a 17 oz. can.*

These blades can hack it



We found that out when we used a *Lenox Hackmaster Reciprocating Blade* on the nail-embedded oak board in the photo above. Lenox uses electron-beam welding to fuse a hardened-steel cutting edge to a flexible back, giving you the best qualities of both wood and metal-cutting blades. These blades come in a wide range of sizes and tooth configurations for both saber saws and portable jigsaws. *Lenox* claims that these blades will outlast conventional blades three to one. *Lenox Hackmaster Reciprocating Blades, \$1.78-\$4.42 each; available nationwide through hardware stores and home centers.*

CONSTANTINE Est. 1812

2054Y Eastchester Road
Bronx, NY 10461

Name _____
Address _____
City _____ State _____ Zip _____

Enclosed is \$1.00. Rush my 116 page, full color catalog.

Craftplans™

21801 Industrial Blvd., Dept. 946
Rogers, MN 55374

Send list of titles (with plan numbers) to Craftplans. Enclose check or money order. Plans are sent postpaid with money-back guarantee. Don't forget your name and address. OR SEND 50¢ FOR CATALOG. \$1.00 HANDLING CHARGE WHEN ORDERING PLANS.

INSTRUCTIONS, IDEAS AND INSPIRATION

27 BIRD HOUSES AND FEEDERS

Simple wren houses to elaborate colony houses. #253 \$2.95



BIRD FEEDERS

Suet holders to "buffets." #397 \$3.95



ANIMATED WEATHERVANES

Lifelike actions by full size weather-vane windmills. #293 \$3.95

ACTION WINDMILLS

15 fullsize patterns. #313 \$3.95

DESIGNS FOR WEATHERVANES

18 designs. #269 \$3.95

DOLLHOUSES

5 plans scaled 1" to one foot. #408 \$2.95

DOLLHOUSE FURNITURE

A variety of pieces. #365 \$2.50

THINGS TO MAKE FOR CHILDREN

20 finest projects. #207 \$2.95



CRADLE

18th century cradle. Full scale plans. #409 \$2.95

FILE CABINET

2 or 4 drawer cabinet with Pendaflex file system. #424 \$5.95



GRANDFATHER CLOCK

Stately floor clock with colonial styling. #430 \$10.25



SHAKER WALL CLOCK

Authentic classic style. 41 1/2"H x 12 1/2"W x 4 3/8"D #431 \$6.95



TV/VCR CABINET

Tambour & flip up doors. Easy access to TV & VCR. 40"H x 36"W x 23 1/2"D. #420 \$6.95

CEDAR CHEST

Traditional style, cedar lined. 46 1/2"L x 22"W x 21"H #415 \$4.95



COMPUTER DESK

Concealed pullout printer compartment and retractable keyboard shelf. 58 1/2"H x 50"W x 30"D. #423 \$5.95

ALPHABETS

6 alphabets, 2" and 3" high #282 \$4.25



TOY CIRCUS TRAIN

Easy to build full scale plans for use with 3/4" material. #406 \$2.95

Total Shop®

The Shape of Pride

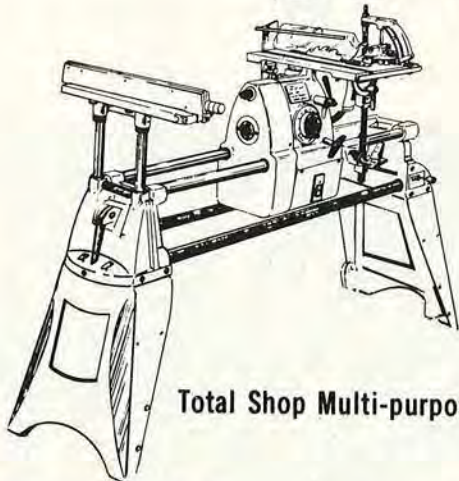

Total Shop Multi-purpose Tool

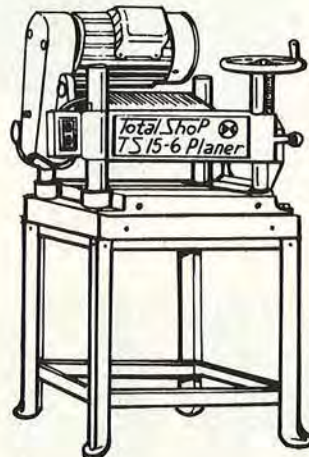

TS 15-6 Planer

What can compare to the sense of pride you feel when you carefully shape a piece of wood into a timeless treasure? Total Shop understands that feeling because we're proud too, and we have the shape to prove it. Our Total Shop multi-purpose tool and TS 15-6 planer are machines with solid power, versatility and stamina.

Compare Total Shop with Shopsmith® and see for yourself. The Total Shop motor produces nearly 40% more power than the Shopsmith® machine and can be altered by the owner to 220V, this is unavailable with Shopsmith®. And in more than 85% of

the comparisons, the Shopsmith® machine was priced higher than the Total Shop machine.

Don't overlook the TS 15-6 planer, a rugged machine convertible to 220V by the owner, optional stand and dust collector available, available with 2HP or 5HP motor, and a full 15" x 6" board capacity. A proud addition to any shop.

Our 30 minute video demonstration tape (available in VHS or Beta) gives you a look at our products in action before you buy. Send for it now (with a \$20.00 refundable deposit) and you'll see what we've been boasting about.

Now available for ALL multi-tool owners! (Total Shop, Shopsmith®, etc.) **An informative 2½ hr. instructional video.** No matter what multi-purpose tool you own, you'll learn more about its set-up, care, and operation. Order today for

only **\$49.95**
(available in VHS or Beta).

Experience the Shape of Pride.
Call

1-800-845-9356
(or in S.C. 288-4174)

and we'll send you 11 additional reasons why Total Shop is a better buy than Shopsmith® plus our free information pride packet.

YES! Please send me your free information pride packet, with 15 reasons Total Shop is the better buy.

- Multi-purpose tool
 TS 15-6 Planer

YES! Please send me the 30 min. demonstration video, I have enclosed a \$20.00 refundable deposit.

- VHS
 Beta

YES! I have enclosed \$49.95 plus \$2.00 shp. & hdl. for the 2½ hr. instructional video on the set-up, care, and operation of my multi-purpose tool.

- VHS
 Beta

Total Shop®

Dept. Q
P.O. Box 16297/Greenville, SC 29606

Name _____
Address _____
City _____
State/Zip _____
Phone _____

Call
Toll Free

1-800-845-9356

or in S.C.
288-4174

GREAT VALUES FROM THE FINE TOOL SHOPS

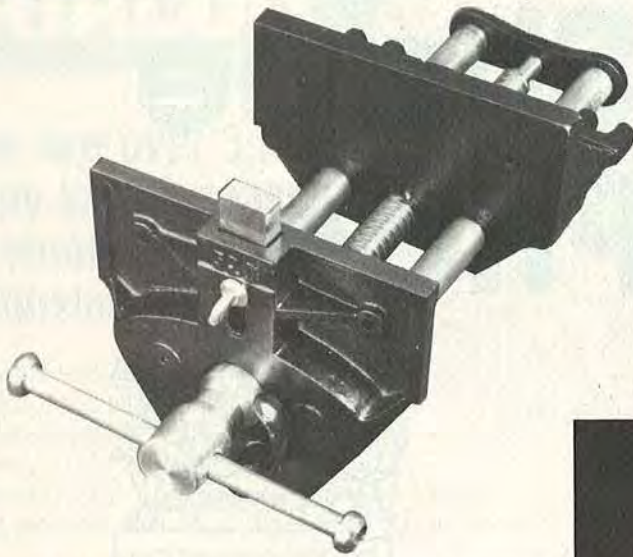

7" WOODWORKERS HEAVY DUTY VISE

- Quick Release Lever.
- Adjustable Front Dog.
- Pretapped holes for adding wood facings.
- 7" Jaw Width. 9" Jaw Opening.

300-0600 22 lbs. *ONLY \$49.00*

A GREAT VALUE !!



6 pc PADAUK HANDLE CHISEL SET

Made for us exclusively by Footprint Works of Sheffield. Hardened, ground, polished, bevel edge blades. Brass ferrules. An outstanding set. Sizes: 1/4", 3/8", 1/2", 5/8", 3/4", 1"

104-0450

*Specially priced
until 28 Feb. '87*

\$24.95

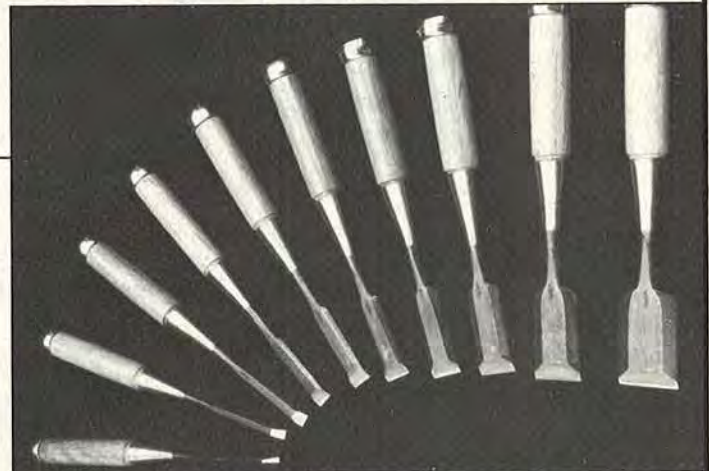

10 pc JAPANESE LAMINATED STEEL CHISEL SET

In the opinion of many, these are the finest cabinetmaker's chisels made. Combination tang and socket construction provide added strength. The iron hoop inhibits splitting. The laminated blade will take and hold the finest, sharpest edge.

Sizes: 1/8, 1/4, 3/8, 1/2, 5/8, 3/4, 7/8, 1, 1 1/4, 1 1/2 (converted from mm)

By special arrangements with the manufacturer, and only until 28 Feb. 1987, we can offer this set for only

104-0020

Regularly \$79.00

\$59.95

SATISFACTION GUARANTEED!

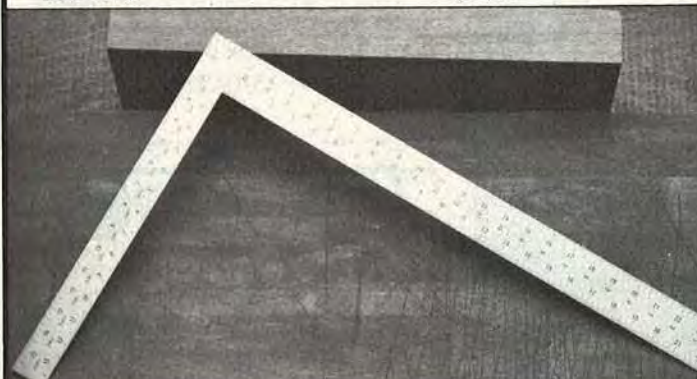

STAINLESS STEEL RAFTER SQUARE

Imbedded, easy-to-read graduations. Polished finish. 24" x 16" x 1/8". Best we have ever seen

108-1015

\$25.00



6' SELF-STICK METAL TAPE

A great convenience. Stick it on any clean surface - - - workbench, lathe bed, sewing table. Can be cut with a scissor if required. 6' x 1/2". Black on white

108-0007

\$3.00

or 4 for

\$9.95

GET \$170 TO MAKE A LOT OF SAWDUST.



Even at regular prices, INCA Bandsaws are hands-down leaders in value. They're the woodworker's choice for resawing, stock sizing, ultra small scroll work, joint making and rapid curve cutting. And at these special sale prices,* they'll be your choice too.

Choose our "smaller" Model 340, sale priced at \$695*—a \$100 savings—cuts to the center of a 21" panel. The built-in motor powers through lumber up to 6" thick. It holds blades from 1/4" to 1/2" wide as standard, and with optional guides it can even hold an incredible 1/16" wide blade.

Want to save more? Choose our Model 710 Bandsaw pictured. It does what the 340 does, and does it bigger. And, at \$1399* it's a tidy \$170 off. Cuts to the center of a 40" panel. Resaws 8" (10" with an extension). Standard guides hold blades from 1/16" to 1" wide. Three speeds. And, motor options up to 1-1/2 hp.

While you're cleaning up on an INCA Bandsaw, pick up an INCA Model 910 Dust Collector. This powerhouse on casters rolls up to your machines and leaves other "vacuums" in its dust with an air flow of 840 cfm through a 4" hose. It's on sale too, for only \$495,* a big \$200 off.

See your INCA Dealer for these great deals and when you're there, look at our other INCA Machines. For the name of the INCA Dealer nearest you, or for more information, call TOLL FREE 800-221-2942 or write to Injecta Machinery Corp., Dept. 549, 10 Van Dam Street, NY NY 10013.

Then watch the sawdust fly.

INCA

*Sale prices good only thru 3/31/87. Stands for bandsaws are extra, but stand plans are free. Price for Models 340 and 910 includes motor.



AND \$200 MORE TO CLEAN IT UP.

Onondaga Indians of New York called it *Ko-yen-ta-ka-ab-tas*, the "white tree," for the wood's pale color. Further south, tribes found the tree's size perfect for long canoes and its soft wood easily worked with their crude tools.

Colonists came and feasted on the strongly flavored honey made by bees from the abundant nectar in the white tree's flowers. The new settlers worked the wood, too — into furniture, interior trim, baskets, and boxes. They named the welcome tree yellow poplar, for the wood's resemblance to stock they had known.

Today, yellow poplar rates as the most valuable hardwood in the eastern U.S. In variety of uses, no other tree can match it. Yellow poplar can be found in construction lumber, moldings, plywood cores, actions in pianos and organs, matches, food containers, paper, woodenware, caskets, and even pool tables. You may find it just as versatile in your workshop, with similar characteristics of higher priced woods.

Wood identification

Yellow poplar, or tulip tree, has a magnolia heritage but a pedigree shared by no other species in the U.S. *Liriodendron tulipifera* grows only in the eastern part of the nation, yet its origins trace back to geological remains in Europe and Asia.

You'll find yellow poplar growing singly among other hardwoods and

YELLOW POPLAR

Willing to work, pleasant to paint, and you can't beat the price!



Yellow poplar sapwood



Yellow poplar heartwood



Yellow poplar streaked heartwood

pinus from the Mississippi River to the Atlantic ocean. The northern limits are central New York; the southern terminus in northern Florida. Rich soil in the Ohio River Valley and the southern Appalachians produce the largest trees, with many yellow poplars attaining 150' in height and girths to 10'. On these specimens, you often don't spot a branch for the first 80'!

Mature trees have thick, light orange-brown bark with many fissures, and frequent burls. Youngsters have bark

that's thin and smooth.

If you can't distinguish yellow poplar by its bark, look to the leaves. Wider than they are long, the leaves resemble saddles.

When you see yellow poplar sapwood, you'll understand why Indians named it for its lack of color. Only a slight creamy tone makes it a bit less white than holly. Heartwood, on the other hand, may be nearly a canary yellow with tinges of green — hence "yellow" poplar. Occasionally, heartwood has dramatic streaks of gray, blue, and dark purple.

Grain is straight, normally featureless, and of medium texture. Light for a hardwood, yellow poplar weighs about 26 pounds per cubic foot dry, compared to red oak's 45 pounds.

Working properties

Yellow poplar has sufficient strength for most shop projects, and outranks many hardwoods in stability, stiffness, and resistance to wear. It works easily with hand tools, and has excellent gluing, nailing, and sanding qualities.

Because of its lack-luster appearance, yellow poplar doesn't lend itself to clear finishes or stain. It does, however, accept paint readily.

Uses in woodworking

Manufacturers find many ways to use yellow poplar, and you will, too.

The straight grain and softness suit carvers. Woodturners find yellow poplar makes wonderful bowls that impart no taste and have no odor. You can easily work the wood into toys, furniture, moldings, and case goods.

Cost and availability

Abundant on the East Coast, yellow poplar becomes less available farther west. Where sold, you can usually find veneer as well as lumber. Boards range up to 20" wide, 16' long, and in thicknesses of 3" or more. Cost may be as low as \$1 per board foot near where it grows. 🌳

Illustrations: Steve Schindler



HITACHI
ROUTER
TR-8
115V AC 60Hz
6.9A 730W
84000 rpm
UL LISTED
812T
DOUBLE INSULATED
When servicing, use only
identical replacement parts.
Hitachi Koki
Hitachi (Japan)
NO. _____
CAUTION
• For safe operation, see
instruction manual. • Always
wear eye protection.
342654

HITACHI

Dave Jordan's
Specialty...

RUSTIC REDWOOD SIGNS

Using his wrists
and fingers to lift
and guide, Dave
free-hands his way
through a sign.

At Lake of the Ozarks, Dave Jordan crafts them freehand, and tells you how it's done

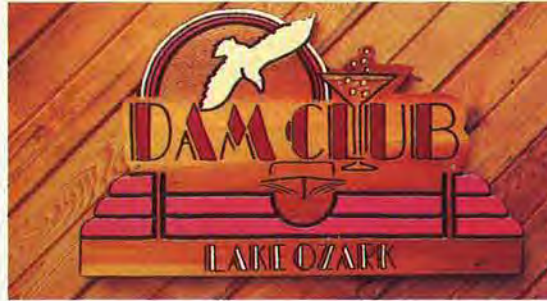

In his “Rustic Redwood Signs” shop, Dave zips through redwood boards, cedar boards, and oak recipe-box lids 12 hours a day from late May to September. In a busy month (as it is most of the summer) he’ll go through 7,000 board feet of redwood alone! And the routing is all done freehand.

Name a name and Dave’s probably cut it into wood. Last names, first names, pets names, boats names, business names — he’s made them all. And quickly.

“A Pantograph or anything else for routing lettering just plain slows you down. With those things you can’t make a sign as fast, or as personally handcrafted, as you can freehand,” Dave explains.

Fast, yes! But dangerous? “About the only thing to worry about is getting dust or wood chips in your eyes. No one would have trouble holding a router back,” he says.

PRACTICE, THEN PRACTICE SOME MORE

Freehand routing does take lots of practice, though. And while Dave is accomplished now, he practiced plenty at first.

He got started making signs quite by accident. Someone stopped by his home and asked if he could make one for them.

“I didn’t know how, but said I would. That night I made it with a router, a round-point bit, and a pine board. The guy liked it. Right then I went out and bought some redwood and practiced every night until I thought my signs looked good enough to sell. I won’t sell anything if I’m not proud of it.”

Since then, Dave has added routed-in scenes, landscapes, buildings, flowers, hearts, cows, pigs, and horses to his signs. But Dave draws the line at pets like a dog or a cat.

“A woman asked me once if I could put a likeness of her dog on her sign. I said ‘Sure, bring me a photograph.’ She did and I painted Spot on the sign for an extra \$1.50. I didn’t think it looked bad, but to her it just wasn’t her dog. I asked her, ‘What do you want for \$1.50, a color portrait?’ So I refuse to do dogs or cats. They’re too personal. You can’t, no matter how much you try, paint pets to the owner’s satisfaction.”

With a paintbrush, Dave is no

Rembrandt. That’s why Lori does most of the painting on their redwood signs. But give Dave a router and you’ll see pure artistry. Among the craftsmen that call themselves “redwood cutters”, Dave has proven by his products that he ranks among the best.

TRICKS OF THE TRADE

Dave maneuvers his router through a board like a snake through prairie grass. In learning to do so, he’s picked up a few tricks of the trade.

The first, using the right wood. Dave goes right to the lumberyard to select his 3/4"-thick, knot-free, clearheart-grade redwood. Even beyond that, he’s finicky. “The closer and tighter the grain, the better it works for free-handing,” advises Dave. “I test mine by running my finger across it. If the nail bumps over the tiny ridges, you know the router will do the same thing. Sometimes you can turn the board over and rout, but if you can’t, don’t use it.”

The minor amounts (compared to redwood) of Tennessee red cedar and white oak he uses pose other problems with no easy solutions. The cedar naturally has knots, which he routes around; the oak he battles through because it’s just plain tough.

Dave has also reversed the handles on his over-the-counter, 1-hp., Hitachi plunge router. This lowers its center of gravity and makes it easier to control from a low, tabletop working position. He also removed the subbase for

Continued



Until we met Dave Jordan, 40 (that’s him at left), we really hadn’t given sign making much thought. But with his freehand routing technique he turns out such great-looking signs that we had to learn just how he does it.

With Lori, his wife and partner, and son, Sean, Dave lives at Lake Ozark, Missouri — a popular vaca-

tion spot. From their shop they sell signs to tourists as souvenirs of an Ozark visit. During the off-season the Jordans travel to shopping malls to market their signs.

Dave made the switch from crafting kitchen accessories to routing redwood about 11 years ago, and now, as you’ll learn, he’s a master at it.

RUSTIC REDWOOD SIGNS



Top left. A dust attachment made from an upholstery nozzle connects Dave's router to his shop vacuum. Otherwise, dust and chips would hinder his vision.

Below left. Dave uses the penciled-on letters as a guide. He calculates spacing as he goes, fills in with a design.

Top right. Black paint, left in the routed letters after sanding, makes them stand out against the background.

Above. Lori paints the scenes most people like on their signs with acrylics. Then, Dave sprays on two coats of tough exterior polyurethane varnish.

a clearer view of the routing path.

To eliminate dust problems, Dave jury-rigged a collection system. He mounted an upholstery nozzle from a household carpet vacuum to the back of his router so that he can connect it with a hose to his shop vacuum.

Dave prefers to use $\frac{1}{2}$ " carbide-tipped, V-groove chamfering bits (which only stay sharp about a month) for most of his lettering. Really large signs call for the wider letters cut by a $\frac{3}{4}$ " bit.

What about clamps? "They only get in the way," Dave says. To keep the stock from slipping he glued down a 12x30" piece of industrial sanding belt to his workbench top. The router's weight, plus the coarse abrasive grit biting the wood, keep the stock rock still.

HOW DAVE ROUTS HIS SIGNS

If Dave followed his instincts, all his signs would end up reading backward. That's because he has dyslexia — the tendency to reverse letters and words. "For the first few years we were in business, Lori had to double-check all spelling because I could cut a name backward as fast as forward. Names still look better to me backward," he muses. So to be safe, Dave takes the name to be routed right off an order form Lori filled out.

In marking the letters down on the board with a grease pencil, Dave doesn't measure, calculate exact spacing, or use any kind of ruler or layout device. Like his routing, he freehands the lettering, too, never planning to follow the lines anyway. They serve only to

guide. "If I end up with too much space on either side after the routing, I'll fudge with the design for balance," he says. "I like to use as much of the board as possible so the letters will be large and readable. That usually works to be about three-fourths of it."

With the letters penciled on, Dave sets the router's cutting depth to the top of the bit's V-shape, and explains: "Most beginners think that the shallower you cut, the better for free-handing. But you can't control shallow cuts. You have to cut deep. This gives the bit more wood to cut, causes drag, and allows you more control."

The router screeches as Dave begins to cut. He guides it down the straights and through the curves of the scrolly, Old English-style let-

ters that he favors as fast and fearless as a Grand Prix racing driver.

His forearms resting on the workbench, Dave's wrists and little fingers direct the routing. The plunges, the lifts, are barely visible as the router moves across the sign board. Twelve letters take him less than two minutes!

Dave doesn't make many mistakes, and he never goes back to correct one. "I'd rather leave that little nick. Fixing it makes a thicker letter that looks worse than the mistake. Just keep the flow going."

ADDING THE FINISHING TOUCHES

To highlight the routed letters, Dave sprays the signboard with flat-black, oil-base enamel, then dries the paint in front of a fan.

In five minutes, the sign's ready for sanding, and Dave moves it to the sanding bench. The board fits between the two wood strips he's fastened to the bench in the shape of a framing square. Like a parking brake, the strips keep the board from being moved by the belt sander.

Dave guides the belt sander lightly over the sign. He removes black paint from all areas except the routed letters, the edges, and cuts that form part of the landscape Lori will paint on in acrylics.

In the sales area of the shop, Lori divides her time between taking orders, painting, and collecting money for the signs. She often seems to do all these jobs at once — talking to customers as she dabs on green, then blue, and tending the register with a wet paint brush in hand. Yet, the shapes emerge: trees, a pond, a country cottage. The theme the customer has chosen highlights and supports the letters, making the sign a one-of-a-kind, personalized artwork.

Two coats of clear, exterior-type polyurethane varnish to withstand the elements, and the sign is ready for the customer to take home and hang. Dave stands behind his product, too. "Satisfaction guaranteed or your money back." But returns are negligible. Dave likes to say that his rustic redwood signs "will go through anything but a divorce."

WELCOME

TO FREEHAND ROUTING

TRY THIS COUNTRY-STYLE SIGN FOR A FIRST-TIME PROJECT

***Note:** You'll need a 3/4x3 3/4x17 1/2" clearheart redwood board for the sign (and several scrap pieces to practice on), a 1/2" V-groove chamfering bit for your router, safety glasses, enough coarse sandpaper to serve as a non-skid pad, flat-black spray enamel paint, blue acrylic paint, and clear exterior polyurethane varnish.*

1 GETTING STARTED

Start by fastening coarse sandpaper (coated side up) to your workbench with double-faced tape or adhesive. Use enough paper to cover an area at least the size of your sign board.

If you can, do as Dave Jordan does and reverse the handles on your router so your grip will be closer to the workpiece. Next, remove the subbase to better view the bit.

2 SAWING THE STOCK AND DRAWING THE LETTERS

On your band saw, or with a jigsaw, cut the jagged "teeth" on both ends of the stock. Draw on the letters and the hearts with a grease pencil.

3 ROUTING VERTICALS

Adjust the bit in the collet so it cuts a furrow the depth of the entire "V". Don your safety glasses, and starting at the left side of the sign blank, cut all the vertical lines first. Work from the top edge of the sign down by pulling the router toward you.

Make the oblong cuts at the tops and bottoms of vertical lines by tilting your router slightly from one side to the other. *Don't* lift the bit out of its path and drop it back down while making these cuts or you'll cut extra width you can't correct. To make rounded letters, cut in one continuous move.



Rout all vertical lines first.

4 ROUTING ACROSS

Cut the horizontal lines from right to left, lifting the router out of the groove just as it intersects with the vertical line.

5 MAKING IT RUSTIC

With your bit set to the same depth used for the letters, make random, irregular chamfering cuts along the edges of the top and bottom, and along the "teeth" sawn on the ends.

Next, adjust your bit to a 1/16" cutting depth and rout the outline of the hearts at the ends of the sign.

6 PAINTING AND FINISHING

Spray black paint into the routed letters, the heart shapes, and on the sign's edges. Let paint dry, then sand with 80-grit sandpaper, leaving the black in the letters and heart outlines, and traces of it on the edges of the board. Paint the hearts, let dry, then coat the sign twice with polyurethane varnish. ♣

Project Design: Dave Jordan
Photographs: Richard Mansur
Produced and written by Peter J. Stephano

CUTTING CURVES—

7 TECHNIQUES THAT CAN INCREASE THE USEFULNESS OF YOUR BAND SAW

 Print this article



When you need to cut simple curves in flat stock, you head for the band saw, right? But it's a shame to limit such a versatile machine to that one simple task. In fact, the band saw does a wider variety of cutting chores than any other saw in our shop.

On the following pages, we share our versions of seven band-sawing techniques you can use to start — or add to — your collection. They're simple and inexpensive, and help expand the usefulness of this machine considerably.

1 HOW TO MAKE STRAIGHT CUTS

Ever try making long, straight cuts using the rip fence on your band saw? If your results came out like ours, you were probably disappointed. The reason: Band saws use thin, narrow, flexible blades — great for cutting curves, but poor performers on the straightaways. Most band-saw blades, we found, want to wander a bit off the cut line, no matter how accurately we set the fence. (The large band saws used for resawing lumber [resaws] are a different breed — they use blades 2" or wider.)

Enter, the pivot block

Rather than try to make our band saw cut straight with a rip fence, we use a pointed pivot block and maneuver the stock to keep the blade on the cut line. A simple solution and it works great!

Actually, we prefer to do most of our ripping and resawing on the table saw because the rigid, circular blade makes a straighter, cleaner cut. We've made a special table-saw jig to help resaw wide boards, featured in the article, *How To Resaw Safely*, in the October, 1985 issue of *WOOD*.

AND MUCH MORE

How to make the pivot block

We use two slightly different kinds of pivot blocks — one for ripping and one for resawing, as shown in the photos. The pivot used for ripping (*photo A*) also works for cutting parallel curves, (*photo C*).

Make the block the same height as the thickness of the stock you're ripping, or the width of stock you're resawing. Notice that the resawing pivot block we used in *photo B* was made for wider stock than the walnut board being resawed. In this case, the block worked fine, but ideally you should lower the saw's blade guides as close to the top of the work as possible for maximum blade support. For help in making a pivot block, see the drawing below.

Note: When making the pivot block, be sure the pivot point (front edge) and base form a precise 90° angle, as shown in the drawing, below left. Otherwise, the pivot point won't be square to the blade when you square the saw table and clamp the block to it.

Using the block

First, select the widest blade your saw will handle, because the wider the blade, the straighter the cut.

Square the table with the saw blade. Then, mark the cut line on the stock and position the mark against the saw blade. Clamp the pivot block to the saw table and

against the stock. Adjust the block so the blade cuts to the outside edge of the mark. Be sure to align the block's pivot point with the cutting edge of the blade.

Note: When marking a piece for cutting, allow an additional 1/8" thickness for planing or jointing to final dimensions.

With the block clamped in position, test-run a piece of scrap wood through the saw to get the feel of the procedure and to make sure the cut will be accurate. If you're resawing, the stock must be vertically square to the blade, or the resawn pieces will be tapered across their width. With the pivot block square to the blade and the stock square to the pivot block, you should not have a problem.

Feed the stock slowly into the saw, using one hand to guide the trailing end as necessary to keep the blade on the cutting line. Use your other hand to hold the stock firmly against the pivot block. Once you get the hang of it, you'll make straight cuts every time.

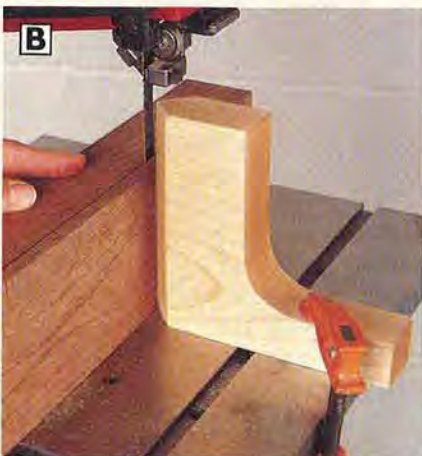

2 HOW TO CUT PRECISE PARALLEL CURVES

You can also use the pivot block to make curved parallel cuts. In use, it does essentially the same thing as for straight cuts: It maintains a uniform distance between the edge of the piece and the cutting line.

To curve stock with it, lay out and mark the first curve cut on the stock, then cut it freehand on the band saw. Sand the cut to remove any rough spots.

Next, set a pencil compass or dividers to the desired width and mark the second (parallel) curve on the stock, using the first curve as a guide. Align the saw blade with the mark for the second curve and cut about 1" into it. Turn off the saw and clamp the pivot block to the table, against the curved edge already cut. For accuracy, make sure the pivot point aligns with the cutting edge of the saw blade.

Guide the board slowly through the saw with one hand while holding the board against the pivot block with the other. Turn the stock as needed to keep the cutting edge at a right angle to the pivot (*photo C*).

With the pivot block, you'll find the second curved cut will be easier to make and will more accurately duplicate the first curve than if attempted freehand.

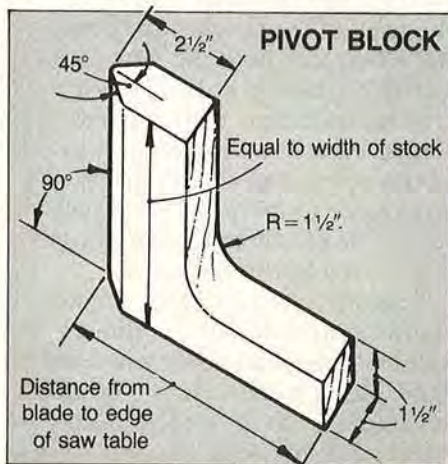

CUTTING CURVES—AND MUCH MORE

3 QUICK CHAMFERS ON A “BACKWARDS” FENCE

If you usually cut chamfers on the band saw with the rip fence positioned on the *downhill* side of the stock, the notched-fence setup in the photo *at right* may look backwards at first glance. But look again! With this fence you can cut the same size chamfer on any straight edge of any size or shape piece *without* having to reset the fence for each cut. So you can chamfer rectangles, octagons, triangles, and similar geometric shapes (not curved pieces).

How to make the fence

From a squared piece of stock, cut the fence slightly longer than the

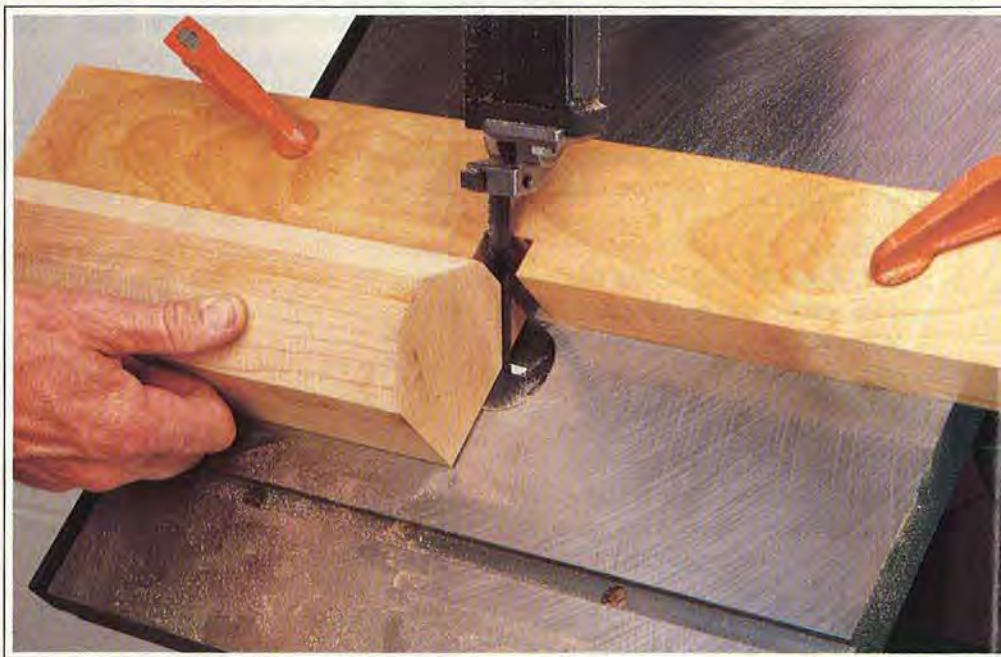

4 CUTTING CIRCLES WITH HELP FROM OUR TABLE EXTENSION

Cutting circles — especially table-top-sized ones — always challenges us. But the sturdy band-saw table extension shown here makes the job unbelievably easy and cuts perfect circles every time.

The secret lies in the four ball-bearing casters inset into the table extension. They allow large, heavy pieces of stock to spin around the extension's pivot point almost effortlessly.

Building the table

If you build the extension to the dimensions shown in the drawing *at right*, the maximum radius you can cut will be 19" plus the distance between the blade and the front edge of your saw's table (7" on our saw, including thickness of angle brackets). With our setup we can cut circles up to 52" in diameter. You may extend the table extension length in order to cut larger circles with it.

How to use the extension table

Attach the table extension to your saw table as shown in the drawing

at right. Draw a centerline on the table extension perpendicular to the *front* edge of the saw blade.

Determine the radius ($\frac{1}{2}$ the diameter) of the circle you want to cut. Then, transfer this measurement to the table extension by measuring out from the saw blade along the centerline of the exten-



sion, as shown in the photo *above*. This point will be the pivot for the circle you'll be cutting. Drill a small hole into the table extension at that point and insert a small finish nail upside down. Let about $\frac{1}{8}$ " of the point protrude.

From the material you're using for the circle, cut a square sheet 2" larger than the diameter of the circle you want. Then cut a 1"-square notch at the center of one side to admit the saw blade.

On the bottom side of the piece, draw a centerline from the cen-



terpoint of the notch you cut to the opposite side of the piece.

Position the piece on the table with the saw blade flush against the back of the notch. Now, lower the workpiece onto the table extension. Line it up so the protruding nail aligns with the centerline marked on the bottom side of the piece. If necessary, tap the workpiece to drive the pivot nail into it, firmly enough so the piece will be stable when rotated.

Start the saw and slowly rotate the workpiece to cut out the circle. On large circles, we use a portable jigsaw to remove the outside waste pieces to keep them from flopping or breaking off.

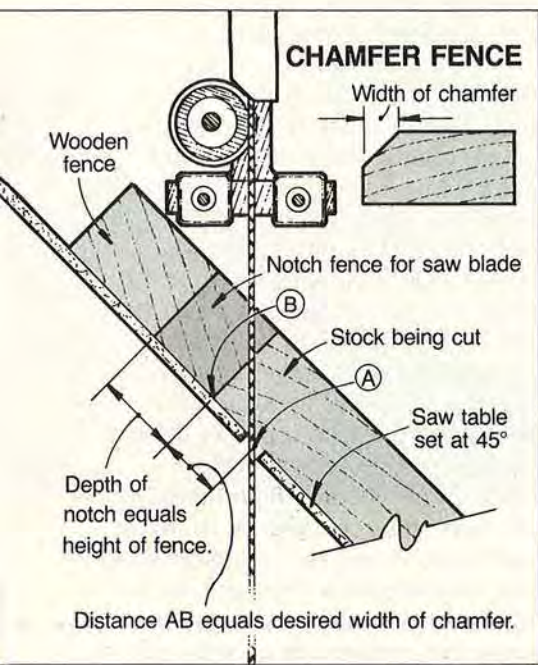

width of your saw table. Cut out a notch in the center of one edge equal in depth to the fence height, as shown in the drawing *at left*. For example, if you're using 2"-thick stock for the fence, cut a notch 2" deep. With the fence, you can cut chamfers any width up to 2", depending on how you set it. Don't worry about notch width — just cut it wide enough for the saw blade, with some clearance for sideways adjustment of the fence.

How to set up the fence

First, tilt the saw table to 45°. Then, from the point where the front side of the saw blade intersects the plane of the table top (*Point A* in the drawing *at left*), measure back up the table

the desired width of the chamfer. Set the front edge of the fence at this point (*B*). In other words, the distance *AB* equals the width of the chamfer you will cut.

Now, with the fence set at the desired distance, square it to the saw table, and clamp it in position. If necessary, raise the blade guide assembly enough to clear the top of the fence.

As a precaution, test the chamfer width on a piece of scrap wood, then make any needed adjustments to the fence. Precise adjustments can be cumbersome to make with the table tilted at 45°, with gravity working against you. If possible, have a helper do the clamping while you hold the fence in the correct position.

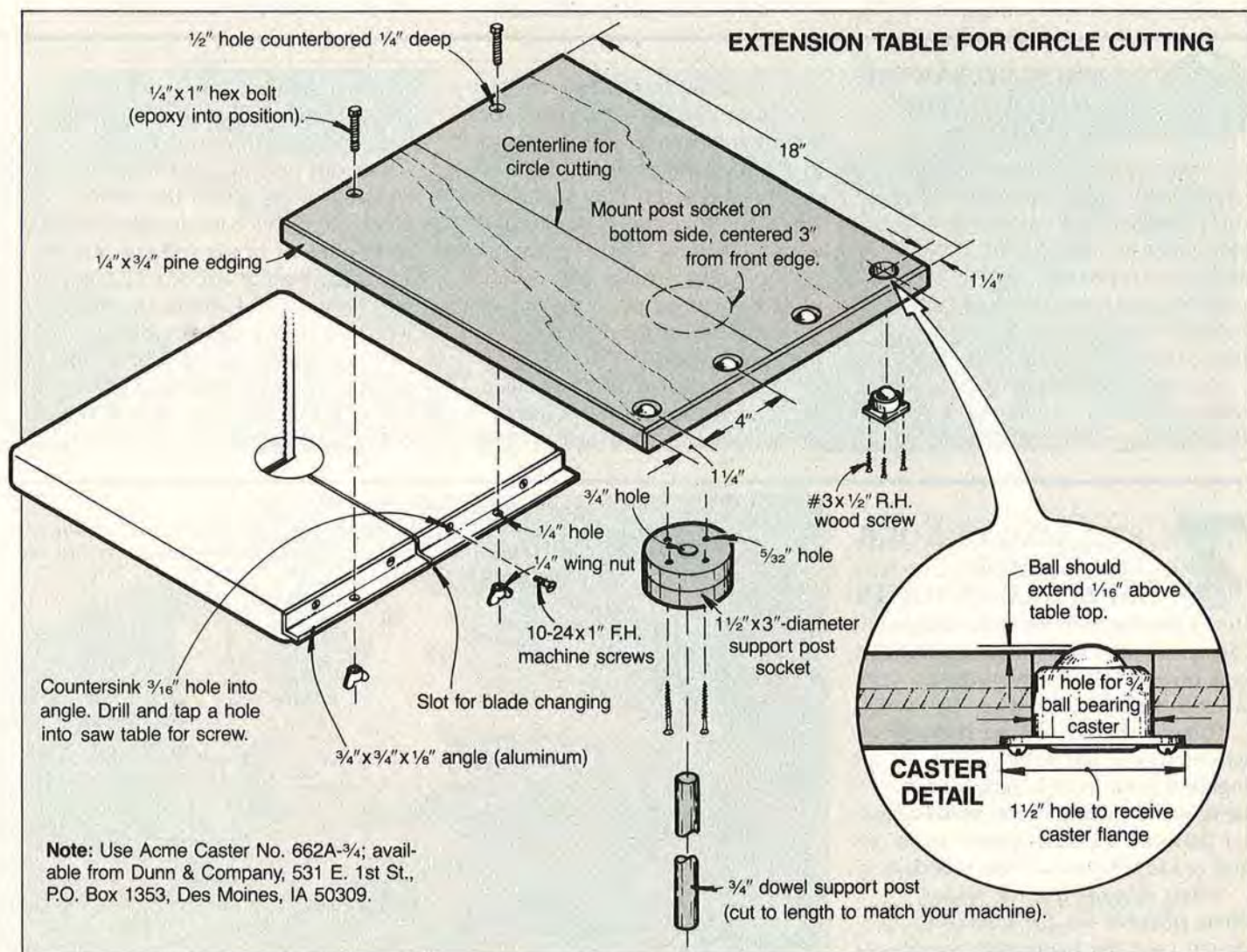

Note: Use Acme Caster No. 662A-3/4; available from Dunn & Company, 531 E. 1st St., P.O. Box 1353, Des Moines, IA 50309.

CUTTING CURVES—AND MUCH MORE

5 A NIFTY WAY TO CUT PRECISE ARCS

Long, smooth, flowing arcs are generally difficult to lay out and cut accurately on the band saw. You'll find them a snap, though, with this useful accessory for the saw extension table described on the previous pages. For lack of a better name, we call our device an *arc trammel*.

Note in the drawing *at right*, that the *trammel head* itself measures only 12" long, so it won't take up much storage space in your shop. With it, you can quickly and easily cut arcs in boards up to 16" long. If you want to cut arcs in longer boards, you can attach a *backer strip* to the trammel head with two screws, to support the long workpiece.

How to make the trammel

Cut the *trammel beam* to a length that equals the distance from the band saw blade to the end of your table extension, minus the width of the trammel head. For other dimensions, refer to the drawing *at right*.

The arc trammel pivots on a metal *trammel point* that clamps to the trammel beam. See photo *at right*. The farther back you attach the trammel point on the beam, the larger the radius of the arc you can cut. You can buy trammel points at most hardware stores and through most mail-order woodworking suppliers.

How to use the arc trammel

If you haven't already done so, draw a centerline on your saw's extension table. (Make sure you

align the centerline with the cutting edge of the saw blade.)

Mark the centerline on the arc trammel head. To do this, attach the trammel point to the trammel beam, against the trammel head. Mark a line across the trammel head that aligns with the pivot point on the trammel point, as shown in the drawing *at right*.

To cut arcs in pieces longer than the trammel head, first cut a backer strip about 3" longer than the piece you're cutting. Attach the backer strip to the trammel head.

Mark the centerpoint of the stock to be cut and align it with the centerline marked on the trammel head. To set the radius of the arc, measure back from the saw blade the desired distance and mark the pivot point on the centerline of the extension table, as shown in the photo on page 42.

6 COMPOUND SAWING TECHNIQUE FOR 3-D CUTOUTS

By sawing on two adjacent sides of the same piece, you can make three-dimensional cutouts quickly and easily on a band saw. Typical applications include carving blocks, cabriole chair legs, and toy boat hulls such as the one we show being cut in the photos *at right*.

You can either make paper patterns as we did, or simply draw the patterns on the workpiece.

If you need to remove the pattern after cutting, use artist's spray mount adhesive to affix the pattern to the workpiece. Available at art supply stores, this adhesive allows you to remove the pattern easily, without leaving adhesive residue on the wood surface. (If you complete the cut on all four sides, the patterns end up being attached to the waste wood.)

Cut a square or rectangular piece of stock to rough dimensions. Attach the patterns to two

adjacent sides of the workpiece. (Note how we did it for the boat hull as shown in *photo 1*.)

Cut out one side of the profile (*photo 1*). Then tack the waste piece or pieces back in place with small nails or brads and cut out the adjoining profile (*photo 2*). Nail into waste wood where the nails won't be hit by the saw blade.

When you complete the second cutout, the waste pieces will fall away, and *voilà!* you have now cut out a double profile.

7 STACKING UP YOUR DUCKS FOR MULTIPLE CUTOUTS

Here's an easy way to make duplicate ducks and any other multiple cuts on your band saw — just stack the pieces.

To keep the stack from shifting while cutting, stick the pieces together with double-faced cloth tape. We found this tape holds better than double-faced paper tape and readily comes off the wood.

When cutting, use the widest blade possible for the curves to be cut (see the blade size chart).

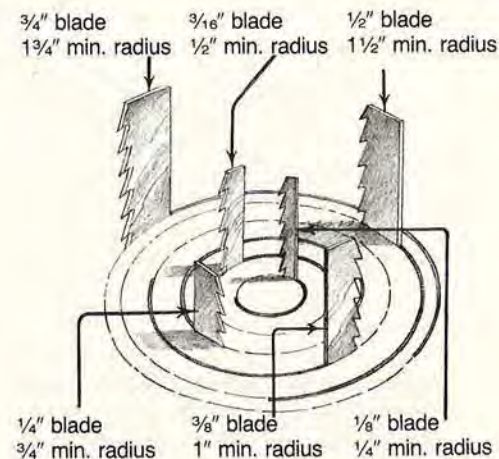
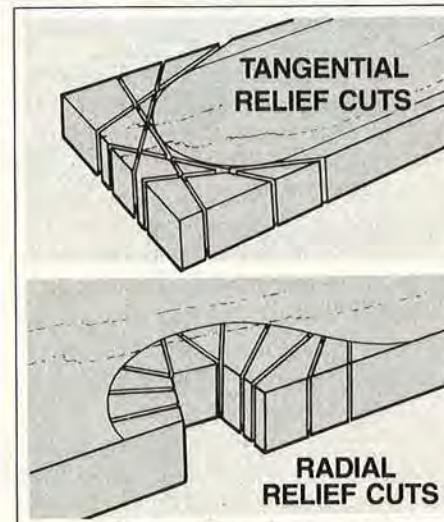

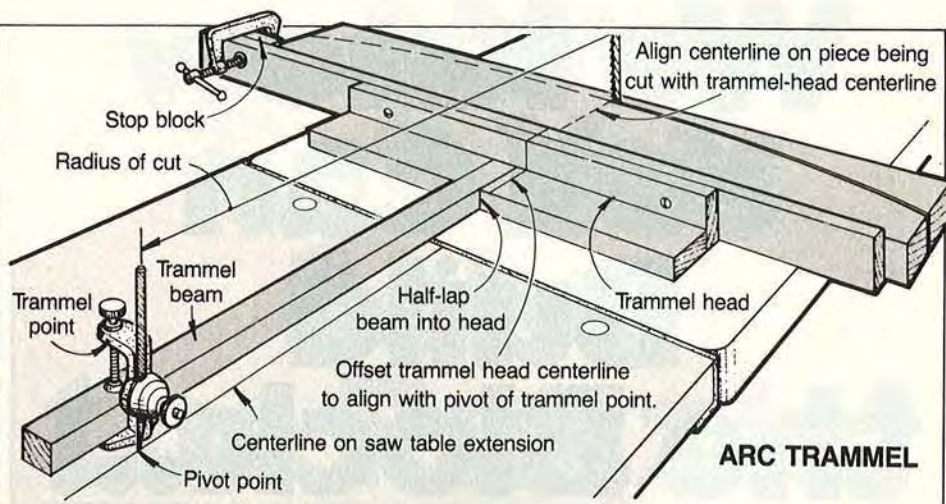

Now position one end of the workpiece against the saw blade at the point where you want to start the cut. Clamp the trammel point to the trammel beam at the pivot point marked on the extension

table; then push the point into the table to act as a pivot.

To cut the arc, steady the trammel point very firmly in the pivot hole with one hand while pivoting the stock slowly through the saw

with the other hand, as shown in the photo (*above left*).

Additional Tip: You can extend the height of the backer strip to stack-cut duplicate parts. See the stack-cutting procedure below.

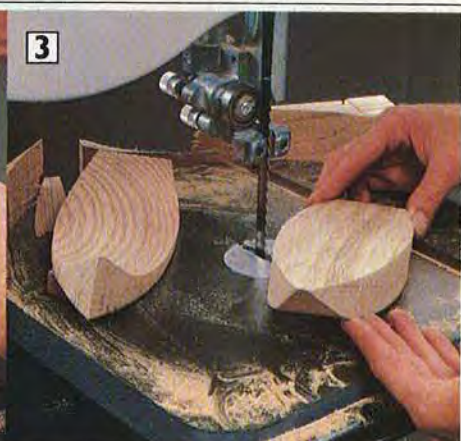

To cut sharp curves with a wide blade, first make a series of *relief cuts* as shown on the drawings *at left*, or drill turning holes as shown in the photo *at left*. Relief cuts allow the waste wood to break away as you cut so the blade doesn't get trapped in a tight curve; turning holes allow room for the blade when stock rotates.

When making large cutouts, plan the route of the cut in advance so the piece clears the back column of the saw as you work. 🌲

By Jim Barrett and James R. Downing
Photographs: Bob Calmer
Illustrations: Bill Zaun

We Know You Can Build the Block...

 Print this article

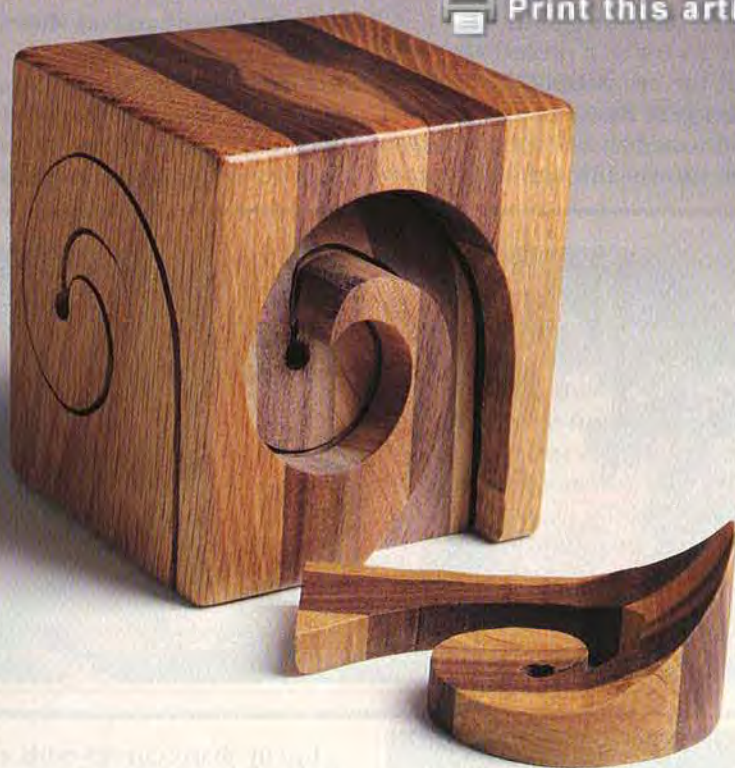

Keep the puzzle pieces in the block as shown *above*, or display them on dowels as shown at *right*.



Test your family's and friend's ingenuity again and again with this laminated-puzzle block. And when displayed, you'll also have an unusual conversational piece to admire.

MAKING AND CUTTING THE LAMINATION

1 Cut two $\frac{3}{4}$ " oak pieces (A), two $\frac{3}{4}$ " walnut pieces (B), and one $\frac{1}{2}$ " cherry piece (C) to the sizes listed in the Bill of Materials. (You can use other scraps you have at hand to form the lamination.)

2 Glue and clamp the pieces together in the configuration shown in the Band-Saw Pattern on the *opposite page*, keeping the edges flush.

3 Scrape off any excess glue, and sand the block smooth. Also, sand a slight round-over on all edges.

4 Using carbon paper, transfer the full-sized Band-Saw Pattern onto *two* pieces of paper measuring $3\frac{1}{2} \times 4$ " each. Apply spray adhesive to the back of the paper patterns and stick them onto two *adjoining* sides of the laminated block.

5 Drill a $\frac{1}{4}$ " hole where shown on the pattern. Drill completely through the block, backing with stock to prevent chip-out. Turn the block to the other pattern, and drill the second $\frac{1}{4}$ " hole completely through the block. (These holes provide a turn-around point for the band-saw blade when cutting the patterns in the next step.)

6 Using a $\frac{1}{8}$ " blade, saw the pattern on one side of the block. Now, tape the block so the cut parts remain in position in the block. Then, rotate the block and cut the second pattern.

7 Remove the patterns and tape from the block and block pieces. Remove the parts from the block and sand all sharp edges and cut surfaces on the pieces smooth.

READYING FOR DISPLAY

1 If you wish to display the puzzle pieces above the block as we do in the photo, drill seven $\frac{1}{4}$ " holes in the top of the block where shown in the drawing at *right* (draw diagonals

from corner to corner to locate the center hole).

2 Cut the 1/4" dowels to the lengths and quantity specified in the Supplies listing. Sand a slight taper on the ends of each dowel for easy insertion into the holes in the top of the block.

3 Position a 1/4" dowel in each of the 1/4" holes in the top of the block. Place the longest dowel in the center; the rest can be arranged in any order you wish.

4 Drill a 1/4" hole 3/8" deep in each puzzle piece for mounting on the dowels. (One at a time, we would hold a block piece on top of a dowel and decide on the best position to drill the hole. Also, drill these holes only on the surfaces cut with the band saw so they will not be visible when you assemble the block.)

5 Finish as desired. (We applied two coats of spray-on polyurethane varnish. The aerosol applicator makes it easier to cover all surfaces of the odd-shaped parts.)

Bill of Materials					
Part	Finished Size			Material	Qty.
	T	W	L		
A	3/4"	3 1/2"	4"	oak	2
B	3/4"	3 1/2"	4"	walnut	2
C	1/2"	3 1/2"	4"	cherry	1

Supplies: Paper for pattern, carbon paper, spray adhesive, finish, 1/4" dowel stems; one each at 2 1/2", 6", and 7", two each at 3 1/2" and 5"

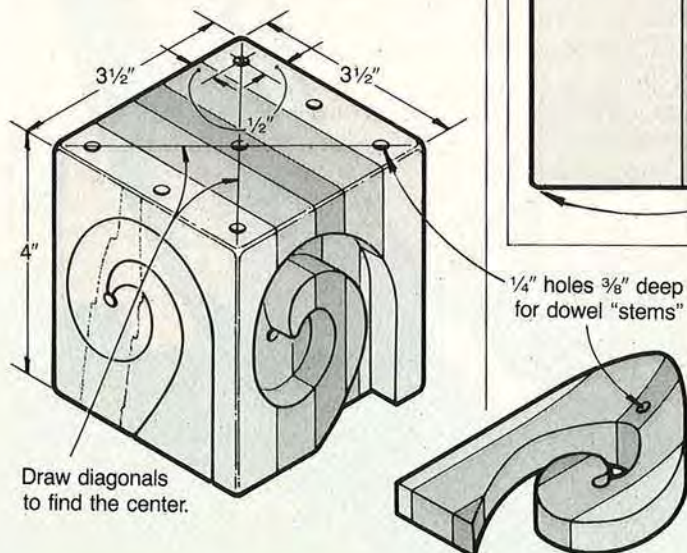

...Now, Can You Solve the Puzzle?

BANDSAW PATTERN (Full Size)

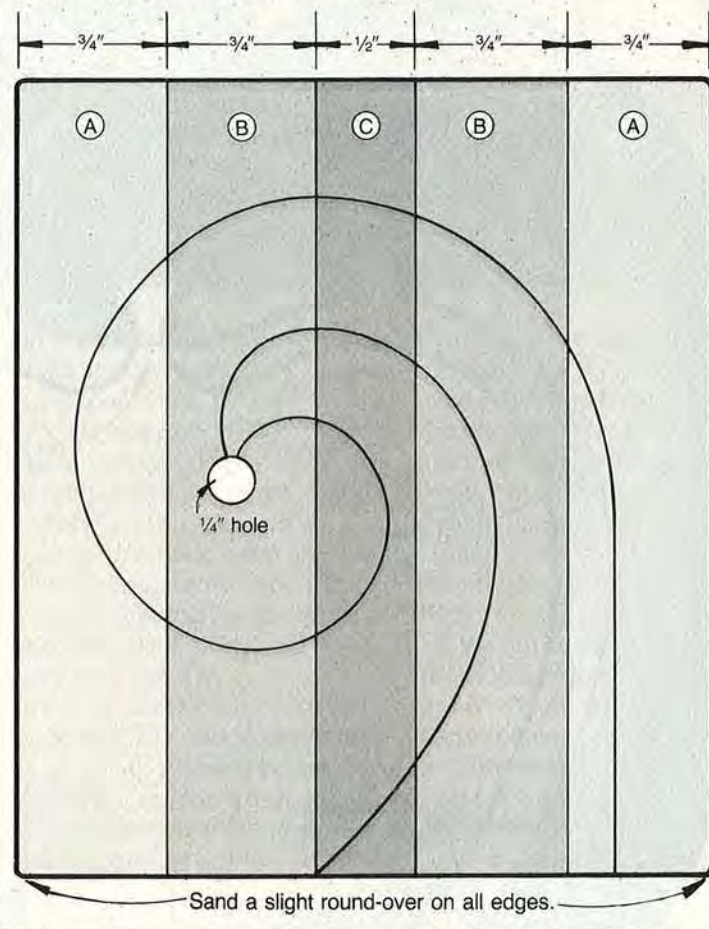

figured out, we removed all the pieces from the block, added the two small pieces, and reassembled the block. (Actually, it is much easier to reassemble the block and pieces than to describe.)

SOLVING THE PUZZLE: Test your ingenuity by putting all the pieces back into the block. (To figure out how the pieces went back together, we first assembled the block without the two small pieces. Once that was

Project Design: James B. Woodruff
Photographs: Hopkins Associates
Illustrations: Bill Zaun

THE "BIG APPLE" BANK

 Print this article

FULL-SIZED PATTERN

Transfer heavy lines to the laminated stock.

Sand a slight round-over on the stem.

1/2" round-over front and back

1/2" round-over stops here

Transfer this line to the 1/8" acrylic.

Coin slot

#2 x 3/8" F.H. brass wood screw

1/16" pilot hole in wood

1/4" rabbet
1/8" deep

3/32" countersunk shank hole in acrylic

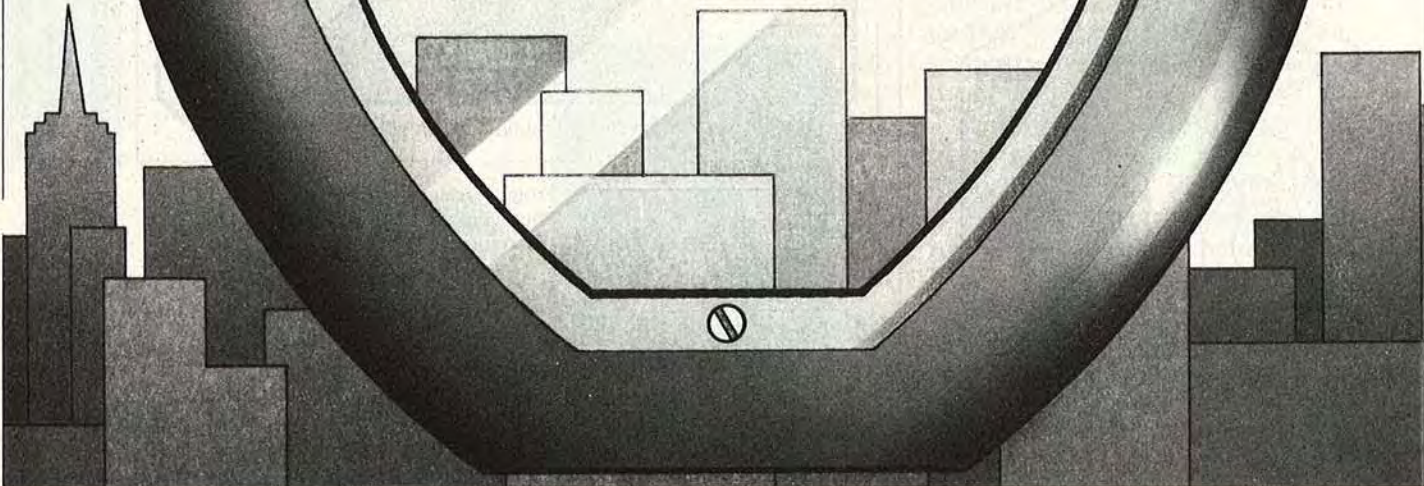

What better way to teach your youngsters thrifty habits than with their very own apple savings bank, where they can see the pennies piling up. You can build the bank with just a band saw and router, and you may not need to travel any further than your scrap box for the materials.

1 Cut two pieces of $\frac{3}{4}$ " stock to 7x8" (we used clear birch). Glue and clamp the two pieces together face to face to make a 1 $\frac{1}{2}$ "-thick blank. Later, after the glue dries, remove the clamps. Crosscut or plane the bottom edge of the blank to obtain a perfectly flat base.

2 Using carbon paper, transfer the full-sized apple and stem patterns to the laminated stock (don't forget the outline of the apple cavity).

3 Fit your band saw with a $\frac{1}{8}$ " blade, and cut the outside outline of the apple and stem to shape. Remove the stem and cut the apple cavity to shape. Sand the cut edges of both pieces smooth to remove all saw marks.

4 Rout a $\frac{1}{4}$ " rabbet $\frac{1}{8}$ " deep along the inside edge of the apple where shown in the drawing. (If you use a different size rabbeting bit, keep the $\frac{1}{8}$ " depth the same, and adjust the size of the acrylic to fit the rabbeted opening.) Repeat the rabbeting procedure on the other face of the apple.

5 Rout a $\frac{1}{2}$ " round-over along the outside edges of the apple, stopping short of the coin slot where shown on the drawing. Sand a slight round-over along the edges of the stem, and finish-sand the pieces.



6 Again using carbon paper, transfer the full-sized acrylic pattern onto a piece of paper. Stick two pieces of 5x5" acrylic together with double-faced tape. Spray adhesive on the back of the pattern, and then stick it to the acrylic. Cut the acrylic to shape using the band saw and $\frac{1}{8}$ " blade. Now, separate the two pieces of acrylic. Test-fit each in the rabbet, and sand the edges of the acrylic if necessary for a good fit.

7 Position an acrylic piece in each rabbet. Now, drill and countersink three $\frac{3}{32}$ " shank holes through the acrylic and just into the wood. Switch to a $\frac{1}{16}$ " bit and drill a $\frac{1}{4}$ "-deep pilot hole in the center of each $\frac{3}{32}$ " hole.

8 Apply a coat of sanding sealer to the apple body and stem. Lightly hand-sand, and then paint the apple red and the stem green. To hold the pieces while painting, drill $\frac{1}{4}$ " holes in the bottom of each apple part and two in a piece of plywood scrap. Mount each apple piece on an 8" length of $\frac{1}{4}$ " dowel stock; then spray with a coat of gloss enamel.

(We stuck the dowel "handles" in the holes in the plywood until the paint dried, and later applied a second coat.)

9 Fasten each acrylic panel in position in the $\frac{1}{4}$ " rabbet, on front and back, with three #2x $\frac{3}{8}$ " flathead brass wood screws.

BUYING GUIDE

•**Rabbeting bit.** $\frac{1}{4}$ " flute length, $\frac{1}{4}$ "-diam. shank, catalog no. RB414, \$25.50. Woodcraft Tools USA, P.O. Box 60906, Sacramento, CA 95860, or call 916/363-9428. 🌲

Project Design: Tom Lewis
Photograph: Hopkins Associates
Illustration: Greg Roberts

BAND SAWS:

Not all band saws look like the Inca 340 pictured here, but the basic parts remain the same. On this saw, the motor is connected to the lower drive wheel on the backside of the saw. Use this photo to help identify the parts as you read this article.

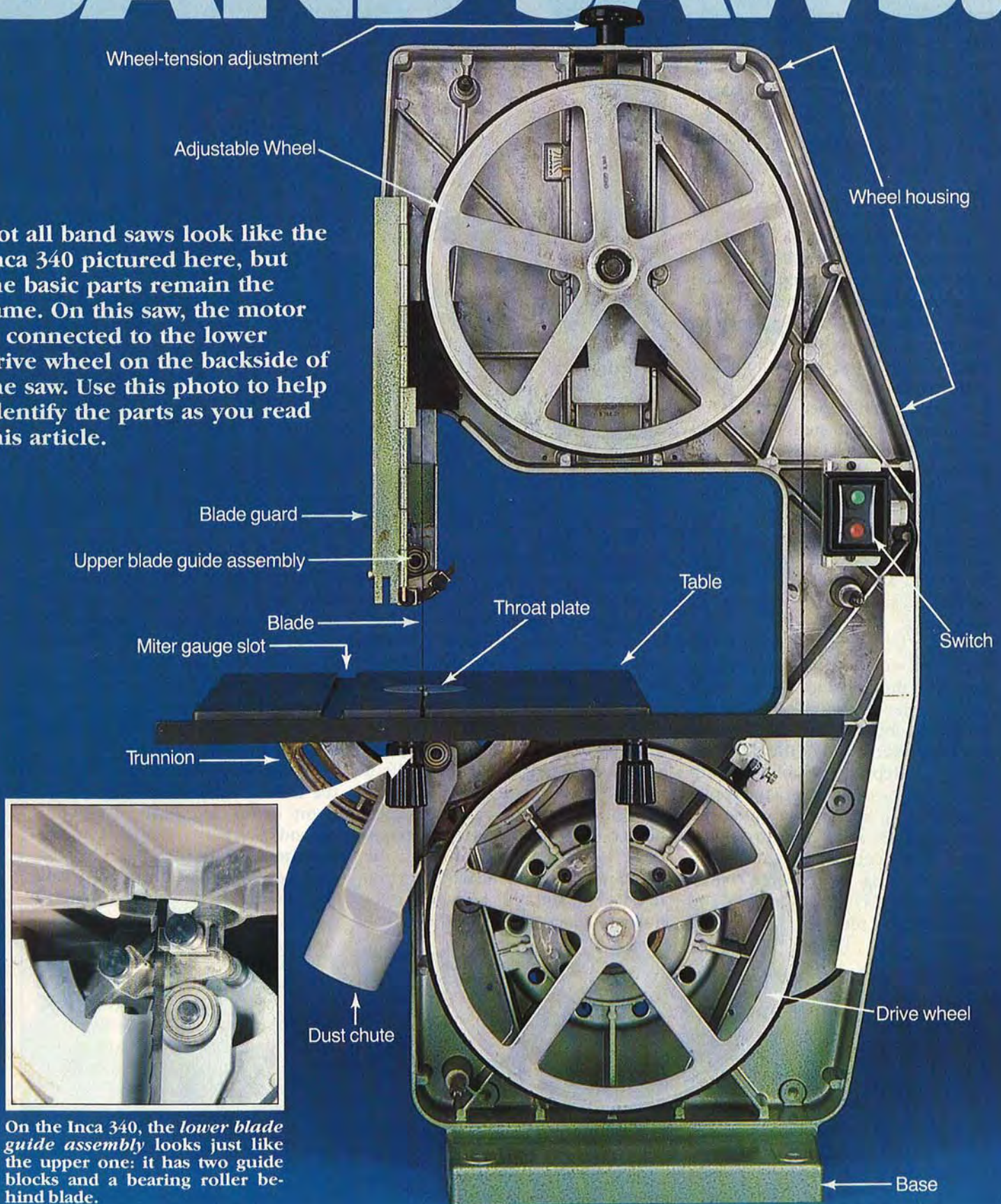

On the Inca 340, the *lower blade guide assembly* looks just like the upper one: it has two guide blocks and a bearing roller behind blade.

FINDING ONE THAT'S RIGHT FOR YOU

ANATOMY OF A BAND SAW

Large or small, two-wheel or three-wheel, all band saws work essentially the same way. A long, flexible, welded-steel *blade* travels on *wheels* supported by a rigid *frame*. Most two-wheel saws have separate *wheel housings* with removable covers so you can change blades. Most three-wheelers, and a few two-wheelers, such as the Inca 340 pictured at left, have a one-piece housing for wheels and blade.

The *motor* drives one of the wheels (drive wheel), either directly off the motor shaft (direct drive) or by means of a belt and pulley system (belt drive).

You adjust the other wheel to control blade tension and tracking with *tensioning* and *wheel tilt* knobs or handles.

Blade guide assemblies located above and beneath the saw table brace and stabilize the flexible blade as you saw. Each adjustable assembly has a *guide block* on either side of the blade to prevent sideways movement, and a *ball-bearing roller guide* behind the blade to prevent backward movement as you feed the stock into the blade. You can raise or lower the *upper guide assembly* (along with the *front blade guard*) to accommodate stock of different thicknesses.

On most band saws, the *table* tilts 45° to the right (as you face the blade teeth); some also tilt up to 10° to the left. A removable *throat plate* or *table insert* covers the hole or slot where the blade passes through the table.

The photo at left shows the workings of a typical two-wheeler (the Inca 340). For an inside view of a three-wheeler, see the Delta 16" band saw (model 28560) pictured on page 52.

From intricate scrollwork to resawing timbers, today's band saws can do an amazing number of cutting chores. But with all the sizes, designs, features, and options available, choosing just the right one can be tough. We've taken a close look at 11 different saws — each under our \$1,000 retail price cutoff — to help you choose a band saw that will do what *you* want it to.

HOW MUCH BAND SAW DO YOU NEED?

The answer to this question depends almost entirely on what kind of work you want to do with the saw. Any machine will cut an occasional curve in a piece of 1" stock, for example. But what if you want to cut thick carving blocks, large panels, or intricate curves, resaw wide boards, or any number of other tasks? Then, a band saw's *throat capacity*, *cutting depth*, and *blade-size adaptability* become important factors in your choice.

The larger the throat, the wider the cut

The widest cut you can make on a band saw equals the distance between the blade and saw frame (column), or its *throat capacity*.

Of the saws we looked at, the Woodmaster 500 has the largest

throat capacity (24½"), perfect for working with large sheet materials (see photo *below left*).

Cutting depth: Most saws have more than enough

The saw's *cutting depth*, measured from the table to the upper guide assembly (at its highest position), determines the maximum thickness of wood you can cut. Cutting heights range from 3" or 4" on the smallest models, to over 7½" on the largest ones. The Delta, AMT, and Jet 14" two-wheel saws have optional riser blocks to extend the cutting height to about 12". On the saws we looked at, power and cutting depth are well matched.

More blade sizes mean greater versatility

Simply put, saws that accept a wide range of blade sizes can make a broad range of cuts, more accurately, than ones that take only a few. Most band saws handle blades from ⅛" to ¾" wide — sufficient for most of the cutting jobs you'd normally want to do on a band saw. For the most accurate cuts, always use the widest possible blade that can saw for the radius of the curve you'll be cutting. A chart on page 44 shows the minimum radius of the curves you can cut with various-size blades.

If you plan to do resawing on the band saw, you may want a saw that takes blades 1½" or wider, such as the Grizzly G1131, Sears 2439, and Royobi BS50N (see photo *page 52*). The Royobi is



At 24½", the Woodmaster Model 500 has the deepest throat capacity of all saws we reviewed. *Above*, we're using it to scallop the edge of a 2'-wide panel. Optional table extenders made it a one-man job.

Continued

BAND SAWS Finding one that's right for you

actually a resawing machine designed to take narrower band saw blades. However, its table doesn't tilt.

At the narrow end of the blade spectrum, the Inca 340 (see photo right) has an optional blade guide assembly that takes a very thin, $\frac{1}{16}$ " blade. It can do much of the work of a scroll saw, except inside cuts. But unlike a scroll saw, which can only cut stock up to 2" thick, the Inca does intricate cutting in stock up to 6" thick. This opens up exciting possibilities if you're interested in unique scrollwork projects.



Above: Inca solved the puzzle of fitting a $\frac{1}{16}$ "-wide blade in a band saw. A special grooved roller guide replaces the standard roller bearing. Right: The Royobi BS-50N comes equipped with a 2"-wide blade to accurately resaw boards up to 7" wide; takes blades down to $\frac{1}{4}$ ".

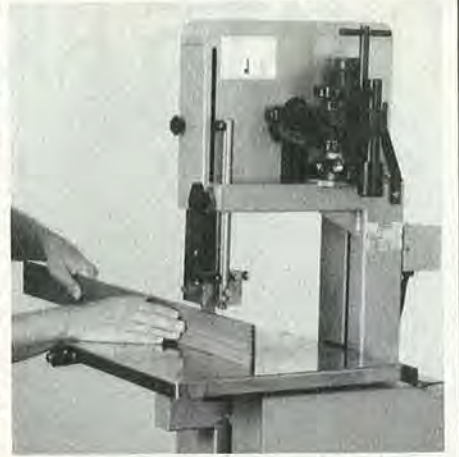

CHOOSING THE RIGHT SIZE SAW FOR YOUR SHOP

First, decide whether you want a *bench-top* model or a larger *stationary* machine. If you're short on shop space, as many of us are, you may prefer a compact bench-top unit. Many of the less expensive bench-top band saws tend to be lightweight "hobbyist" machines. But these "under \$200" units will give adequate results if you limit them to light, occasional use. But don't expect them to perform like the more expensive saws.

If you want a small, bench-top saw that performs like a pro, we suggest you look at the Inca 340, Royobi BS-50N, and the Sears 2439. They're heavy-duty saws in a small package.

If you want a more powerful saw with larger capacity, you'll need to go with a stationary machine. These usually require stands, though you may be able to mount the smaller units on a bench.

With the exception of the Woodmaster 500, the stationary saws we looked at take up about the same amount of *floor space*, give or take a few square feet. However, the amount of shop space you devote to your saw may depend more on the type of work you'll be doing on it than the physical dimensions of the saw. For instance, big saws such as the Woodmaster 500 and Grizzly G1131, need ample space around them, if you plan on using

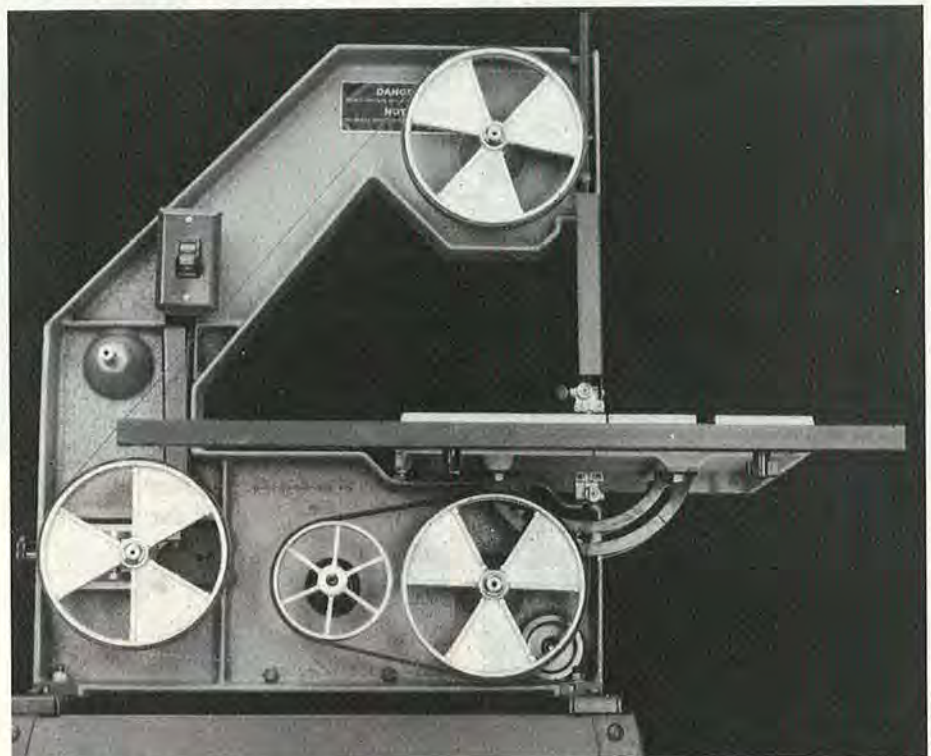

Delta 16" band saw shows typical three-wheel construction, which allows more throat depth than two-wheel saws. You

can lower blade speed for cutting ferrous metals by removing pulley and running a smaller belt directly off motor arbor.

them for the large jobs they're designed to handle. See the chart on page 55 for overall dimensions.

Two- And Three-Wheel Saws: which is better?

This depends on the tradeoff you want to make — more throat capacity or longer blade life. The three-wheel design offers a greater

throat capacity in relationship to the overall size and weight of the saw. However, the three-wheelers have somewhat of a reputation for breaking blades more frequently than the two-wheelers. Also, you'll find that the three-wheel saws usually take longer to adjust to get the blade tracking correctly.

WHAT TO LOOK FOR IN A QUALITY SAW



Mini Max precision-balances their cast-iron band saw wheels by drilling holes in the rim. We found this saw runs smoother than all the others we tried.

Motors: The driving force

All stationary saws and most bench-top units use induction motors. Several of the smaller bench top units use universal motors. Generally, the small size, high rpm, and limited brush life of universal motors make them more suitable for portable power tools than for larger machines.

Most of the saws we looked at have *totally enclosed, fan-cooled (TEFC) motors*. These motors hold up longer in a shop environment than motors with ventilated housings. If you buy a band saw without a motor, we suggest you equip it with a TEFC motor.

On the saws we looked at, motors ranged from $\frac{1}{5}$ to $2\frac{1}{2}$ hp. In all cases, we found the motors well matched to the saw's physical cutting capacities.

Wheels: The key to smooth, vibration-free operation

Most band saws use cast-iron or cast-aluminum wheels; some of the bench-top units have plastic wheels.

Wheels may be wheels, but the heavier cast-iron wheels develop more momentum than aluminum ones, and this helps keep the blade from bogging down when cutting.

Also, saws with heavy, well-balanced wheels run more smoothly, with less noise and vibration.

Wheel housings

These are usually stamped (sheet) steel or high-impact plastic. One exception: the cast-aluminum housing on the Inca, which forms part of the frame. On other saws, the housing attaches to the frame and does not add to its rigidity.

If you expect to be changing blades frequently, check to see how easily you can remove and replace the housing covers. You'll find some fasteners easier to work than others. Also make sure the covers attach squarely and snugly against the housing — a loose wheel housing adds to vibration and noise when operating the saw.

Frame — check rigidity

Think of the band saw's frame as its backbone — it has to support the two or three spinning wheels placed under tension by the blade. If the blade flexes or warps the frame, your cuts will suffer. To check frame rigidity, grasp a side of the table with one hand and push against the side of the top wheel cover with the other.

Band saws have frames of cast iron, cast aluminum, or steel. These materials make rigid frames if they're thick enough and the frame itself has a rigid design. On cast-iron and cast-aluminum frames, a ribbed design provides greater rigidity with minimal warp, and keeps weight down.

Tables: Are they easy to tilt?

Most band saw tables tilt 45° to the right; some also tilt up to 10° to the left. The Royobi's table doesn't tilt because it's primarily a resaw.

Check for smooth operation when tilting the table, and make sure the locking knobs on the trunnions hold the table firmly at any angle without having to apply too much pressure to them. We particularly liked the smooth operation of the heavy cast-iron table on the Grizzly, shown in the photo *left*. Its yoke-and-cradle trunnion design provides solid support for the table and positive locking.

Also check that the throat plate fits snugly and sits flush with the table surface. You don't want the work snagging on it while sawing or having the blade cut into it. We prefer plastic throat plates to metal ones because they're less likely to damage the blades should they hit it.

As saw tables go, those on band saws are relatively small — typically 12"-14" square. For most band saw work, you won't need a table much larger than this. If you do, some band-saw manufacturers offer table extensions (see chart on page 55).



Sturdy trunnions provide solid support for the heavy cast-iron table on the Grizzly 18" saw. Tilting this saw's table is easier than you may think.



Small table extension attaches to front or either side of table on AMT 14" saw. This saw also has optional riser block to extend cutting height to 12".

BAND SAWS Finding one that's right for you



Here are 10 of the 11 saws we tried out: 1. Elektra Beckum Model BAS 315¼ (12"), 2. AMT Model 4112 (14"), 3. Grizzly Model G1131 (18"), 4. Inca Model 340 (10½"), 5. Royobi Model BS-50N (9¼").



6. Mini Max Professional 32, Model P 32 (12"), 7. Delta Motorized Band Saw (three wheel) Model 28-560 (16"), 8. Delta Model 28243 (14"), 9. Skil Model 3104 (10"), 10. Delta Motorized Band Saw Model 28-160 (10").

OTHER DESIGN FEATURES TO CONSIDER

Blade adjustments

Band saws have more blade adjustments than any other saw you'll own. So, if you anticipate changing blades frequently, you'll appreciate having these mechanisms conveniently located and as easy to operate as possible.

Blade tension and tracking adjustments have large knobs or levers protruding through the wheel housing. You shouldn't have to apply a lot of muscle to turn them — just make sure they operate smoothly and easily.

Saws with built-in blade-tension indicators help take the guesswork out of tensioning the blade. We like those with scales indicating correct tension for the blade width, such as the one used on the Delta saws. Saws without tension indicators require some trial-and-error adjusting until you get used to the saw.

Blade guide assemblies should be easy to get to for adjustment. In some cases you have to remove the throat plate to gain access to the lower guide assembly.



Above: Microadjustments on Delta 14" saw provide precision control on roller guides and guide-assembly carriage.

Right: Removable switch toggle prevents accidental starting of saw — a good feature when young folks visit your shop.

On most saws, you'll need a wrench to adjust the guide blocks. We like the knurled knobs on the Inca's guide-block adjustments because they allow you to adjust the guide blocks easily by hand — without a wrench (see photo on page 50). We also like micro-adjustment knobs for the ball-bearing roller guides and guide-assembly carriage, like those shown in the photo *above*. They allow you to "fine-tune" the guides.



Switches: Safety first

We like to have a switch within easy reach from the saw operator's position. Then, if you have to turn off the saw in a hurry, such as when a blade breaks, you can do it. Also, you shouldn't have to reach across the saw to turn it off.

Some of the Delta saws and the Skil 3104 have removable switch toggles so you can lock the switch in the *OFF* position when the saw's not in use (see photo *above*).

BAND SAW BUYMANSHIP

MANUFACTURER	MODEL	TYPE ¹	NOMINAL SIZE	THROAT CAPACITY	CUTTING HEIGHT	BLADE WIDTHS	WHEELS			TABLE			POWER TRAIN				FRAME MATERIAL ⁷			HEIGHT ⁸		WIDTH	DEPTH	ACCESSORIES ⁹		WEIGHT	SUGGESTED ¹⁰ RETAIL
							NUMBER	MATERIAL ²	BEARINGS ³	SIZE	TILT	MATERIAL ⁴	VOLTS	HORSEPOWER	DRIVE ⁵	BLADE SPEED (SFPM) ⁶	HEIGHT ⁸	WIDTH	DEPTH	STANDARD	OPTIONAL						
AMT ¹¹	4112	S	14"	13 3/4"	6"	1/8"-3/4"	2	A	B	14"x14"	45°R	CI	115	3/4	BP	3,000	CI	66"	22"	25"	S	F,M,E	163	\$348			
Black & Decker	9422	B	7 1/2"	7 1/2"	3 3/4"	1/8"-3/4"	2	P	S	10"x10"	45°R	FS	120	1/2	BP	650	CI	36"	10"	16"	M,MR	—	27	\$100			
Delta	28160	B	10"	12"	4"	1/8"-3/8"	3	CA	B	11 1/2"x11 1/2"	45°R	CA	115	1/2	D	2,700	CA	22 1/16"	12 13/16"	23 1/4"	M,MR	—	40.5	\$158			
Delta	28560	S	16"	16"	8"	1/8"-3/4"	3	CA	B	16"x16"	3°L 45°R	CI	115	1/2	BP	450, 2,400	CI	60 5/8"	31"	21"	S,F, MR,M	—	156	\$467			
Delta ¹²	28243	S	14"	13 3/4"	6 1/4"	1/8"-3/4"	2	CA	B	14"x14"	10°L 45°R	CI	SPECIFIES 1/2-3/4 hp		BP	3,000	CI	65 1/2"	25"	17 1/2"	S	MR,F, M	174	\$621			
Elektra Beckum	BAS 315/4	S	—	12 1/4"	6 3/4"	3/8"-3/4"	2	CA	B	14 1/4"x15 3/4"	45°R	CA	220	2.4	D	3,082	S	74"	24"	23"	FS MR	M,CC, SA,E	121	\$895			
Foley Belsaw	480	S	14"	14 1/8"	6"	to 3/8"	2	CA	B	13 3/4"x13 3/4"	45°R	CI	115	1/2	BP	2,500	CA	66 1/2"	28 1/2"	25 1/2"	F,M, MR	—	158	\$700			
General	490	S	15"	14 3/4"	6 3/4"	to 3/4"	2	CI	B	15"x15"	10°L 45°R	CI	SPECIFIES 1/2-1 1/2 hp		BP	3,000	CI	66 1/2"	18"	26 3/4"	S	F,M, MR	295	\$692			
Grizzly ¹³	G1131	S	18"	18 1/8"	7 7/8"	1/4"-1 1/2"	2	CA	B	15"x15"	10°L 45°R	CI	110/220	2	BP	650	CI	68 1/2"	35"	20"	MR,F	M	360	\$595			
Inca ¹⁴	340	B	10 1/2"	10 1/2"	6"	1/4"-1/2"	2	CA	B,N	12 1/2"x12 1/2"	45°R	AA	110	3/4	D	3,281	CA	35"	23"	18"	F,MR	S,M, SA,CC	55	\$695			
Jet	DBS14	B	14"	14"	5"	1/4"-3/8"	3	CA	B	15 3/4"x15 3/4"	45°R	CA	115/230	1/2	BP	4,650 3,000 637	S	28"	17 1/2"	28 3/4"	F,MR, SA, CC	—	56	\$202.65			
Jet	DBS12	B	12"	12"	4 5/8"	1/8"-3/8"	3	P	S	13 1/2"x13 1/2"	45°R	CA	115	3/4	G	0-2645	CA	22 3/8"	24 1/2"	13 1/2"	M,F, SA,MR	—	29	\$183.75			
Jet ¹⁵	JBS14MW	S	14"	13 5/8"	6"	1/8"-3/4"	2	CA	B	14"x14"	45°R 10°L	CI	115/230	1	BP	2,350 1,470 735	S	65 1/2"	24 1/2"	19 1/4"	M,MR	—	211	\$390.60			
Mini Max	PRO 32	S	12 1/2"	12 3/8"	6 1/2"	1/8"-3/4"	2	CI	B	15"x15"	45°R	CI	115	3/4	D	3,000	S	39"	22.8"	21.2"	S,MR, F	M	147	\$615			
Royobi ¹⁶	BS-50N	B	—	9 1/4"	7"	1/4"-2"	2	CA	B	15 3/4"x15 3/4"	NO	SS	120	2 1/2	BP	1,308	S	34 5/8"	25 3/16"	17 3/4"	MR,F	—	110	\$1,249*			
Sears	24331	S	12"	12"	6"	1/8"-1/2"	2	CA	B	14"x12 1/2"	45°R	CA	120	1/2	BP	2,800	CA	36"	24"	14 3/16"	S,SA, MR	M,CC, E	120	\$439.99			
Sears	24447	S	10"	10"	4"	1/4"-3/8"	2	CA	B	14"x12 1/2"	45°R	CA	120	1/3	D	3,700	S	34 3/4"	22 1/2"	14 1/2"	MR,S	CC	70	\$279.99			
Sears	24451	B	10"	10"	3"	1/4"	3	CA	B	11 1/2"x11 1/2"	45°R	AA	120	1/2	D	1,700	CA	23"	13 1/2"	22"	MR	S,M	45	\$109.99			
Skil ¹⁷	3104	B	10"	10"	4"	1/8"-1/2"	3	P	S	14"x13"	45°R	CA	120	5/8	D	500-2,000	S	24 1/2"	24 1/4"	15"	F,MR, M	SA	32	\$199.99			
Woodmaster	500	S	24"	24 1/2"	9"	1/8"-1/2"	3	CI	B	12"x12"	10°L 48°R	FS	SPECIFIES 1/2-3/4 hp		BP	2,050 1,650 1,375	S	69 1/2"	24"	35"	—	MR,F, E,S	165	\$599			

- 1 - (B) Bench top (S) Stationary
- 2 - (CI) Cast-iron (CA) Cast-aluminum (P) Plastic
- 3 - (B) Ball (S) Sleeve (N) Needle
- 4 - (CI) Cast-iron (CA) Cast-aluminum (AA) Anodized aluminum (SS) Stainless steel (P) Plastic (FS) Formed steel
- 5 - (D) Direct drive (BP) Belt and pulley

- 6 - Surface feet per minute
- 7 - (CI) Cast-iron (CA) Cast-aluminum (S) Steel
- 8 - Includes height of stand on stationary saws
- 9 - (F) Rip fence (MR) Motor (M) Miter gauge (E) Table extension (S) Stand (SA) Sanding attachment (CC) Circle-cutting attachment

- 10 - Most saws discounted 10-30% below suggested retail price
- 11 - Grizzly, Wilke offer similar saw
- 12 - Delta 28283 is same machine with 3/4-hp motor, enclosed stand and work lamp
- 13 - Jet offers similar saw
- 14 - Inca 310 is same saw without motor; 320 is driven by electric drill

- 15 - Jepson offers similar saw
 - 16 - Sears offers similar saw, equipped with 3/4-hp induction motor
 - 17 - Sears offers similar saw
- *Suggested list price of Royobi BS-50N increased from \$995 to \$1,295 between time of writing and publication, but generally available for under \$1,000 at retail outlets.

Rip fences and miter gauges: Do you really need them?

If you already have the appropriate saws for making rips, crosscuts, and angled cuts, the answer is "no." Even though rip fences and miter gauges come as standard or optional equipment on most band saws, the saw itself will not make a straight cut as accurately as a table saw, miter saw, or radial arm saw. However, you can get a reasonably straight cut on a band saw by using

a pivot block, described on page 41. Also, band saws designed for resawing, such as the Royobi BS50N, do require an accurate fence.

Actually, we prefer to do our resawing on the table saw, with the help of our homemade jig. See the October, 1985 issue of *WOOD* (pgs. 44-47), for details.

Accessories add versatility

Optional band saw accessories

include circle-cutting attachments, depth stops (for cutting mortise and tenon joints), belt-sanding attachments, worklights, attachments for dust collectors, table extensions, and roller supports for working with large stock. The chart *above* lists some of these. You'll also find some nifty accessories you can make for your band saw on pages 40-45 in this issue. 🌿

Produced with George Granseth
Photographs: Bob Calmer

ROUTER STRAIGHTEDGE

Makes dadoses and edge-jointing a snap

If you have ever put off building a project because it called for extra-long or tough-to-do dadoses, wait no more. Here comes our router straightedge to the rescue. You can make it in a few hours for under \$10. And with it, you can just as easily rout one or a dozen dadoses, stopped or not. Plus, edge-jointing with your router also becomes a snap. So throw on your shop apron and safety glasses and let's head for the workshop!



ASSEMBLING THE FENCE

Note: The finished width of the base (A) will depend upon the size of the plastic subbase of your router and the size of straight bit used. As stated in the directions, we cut our base extra wide and then trimmed it to finished width later with a $\frac{3}{4}$ " straight bit.

1 From $\frac{1}{2}$ " plywood (we used 9-ply Baltic birch), rip and cross-cut the base (A) and guide (B) to the sizes listed in the Bill of Materials. Keep the front edge of the guide perfectly straight, joint if necessary. When using later, the router slides along this edge and transfers any imperfections to the workpiece.

2 Cut or rout a $\frac{1}{8}$ " rabbet $\frac{1}{8}$ " deep along one edge of the guide piece. When using, this rabbet acts as a sawdust notch.

3 To lay out the $\frac{3}{16}$ " holes on the base, draw a line the length of the base 2" from what will be the back edge where shown in the drawing. Now, using a compass or dividers set at 2", step off and mark the hole locations on the base. Clamp a fence to your drill press and drill $\frac{3}{16}$ " holes through the plywood base where marked. Back the piece with scrap to prevent chip-out.

4 Countersink every $\frac{3}{16}$ " hole on the bottom side of the base to prevent the screwheads from scratching the piece being dadoed later.

5 Glue and clamp the guide piece to the base with the back edges and ends flush. Remove any glue squeeze-out from the sawdust notch before it dries. Sand the assembly smooth.

6 To trim the base to finished width, mount the straight bit you will use most often for routing dadoses (we used a $\frac{3}{4}$ " bit) in your router. Clamp the base and guide assembly on the edge of your workbench, and rout $\frac{1}{4}$ " into the plywood base (A). Check that the second cut won't hit your workbench, adjust the bit depth to cut all the way through, and finish routing through the base.

MAKING THE STOPS

1 Cut a piece of the same $\frac{1}{2}$ " material used for the base and guide to 4x10". Using the Stop Drawing at right as a guide, lay out the stop (C) outline and slot location onto the blank where shown in the photo below. Repeat for the other stop.

2 Drill a $\frac{1}{4}$ " hole at each end of each marked slot.

3 Fit a $\frac{1}{4}$ " straight bit in your table-mounted router. Now, clamp a fence to the router table so the center of the straight bit is $\frac{1}{2}$ " from the inside edge of the fence.



4 Position the stop blank against the fence with the router bit protruding through one of the $\frac{1}{4}$ " holes in the blank. Holding the blank firmly against the fence with one hand, start the router with the other, and rout from hole to hole to form the slot as shown in the photo lower left. (In addition to using the $\frac{1}{4}$ " holes as stop points, we also clamped a stop to the router table as shown in the photo.) Repeat this step to rout the slot in the second stop.

5 Cut or rout a $\frac{1}{8}$ " rabbet $\frac{1}{8}$ " deep along each end of the stop blank (see the Stop Drawing for location) to act as sawdust notches. Cut the stops to shape from the blank with a hand saw or scroll saw. Sand both pieces smooth.

6 Apply the finish to the stops, base, and guide. Applying a small amount of paraffin to the top surface of the base helps the router slide more easily. Attach the stops to the straightedge with $\frac{3}{16}$ " flathead machine screws, washers, and wing nuts.

PUTTING THE STRAIGHTEDGE TO WORK

Start by laying out the location of the dadoses or stopped dadoses needed on the workpiece, and set the straight bit to the needed depth. With the router turned off, position it on the base, check the position of the straight bit against the marked dado, and clamp the straightedge in position. If you plan on cutting dadoses with the same straight bit used in step 6, position the front edge of the base directly on the inside line marking the dado. If using a larger or smaller bit, you will need to adjust the position of the straightedge accordingly. Holding the router firmly against the guide, start the router, and move it into the wood and along the guide to cut the dado. Move the router in the direction noted by the arrow on the Exploded-View Drawing.

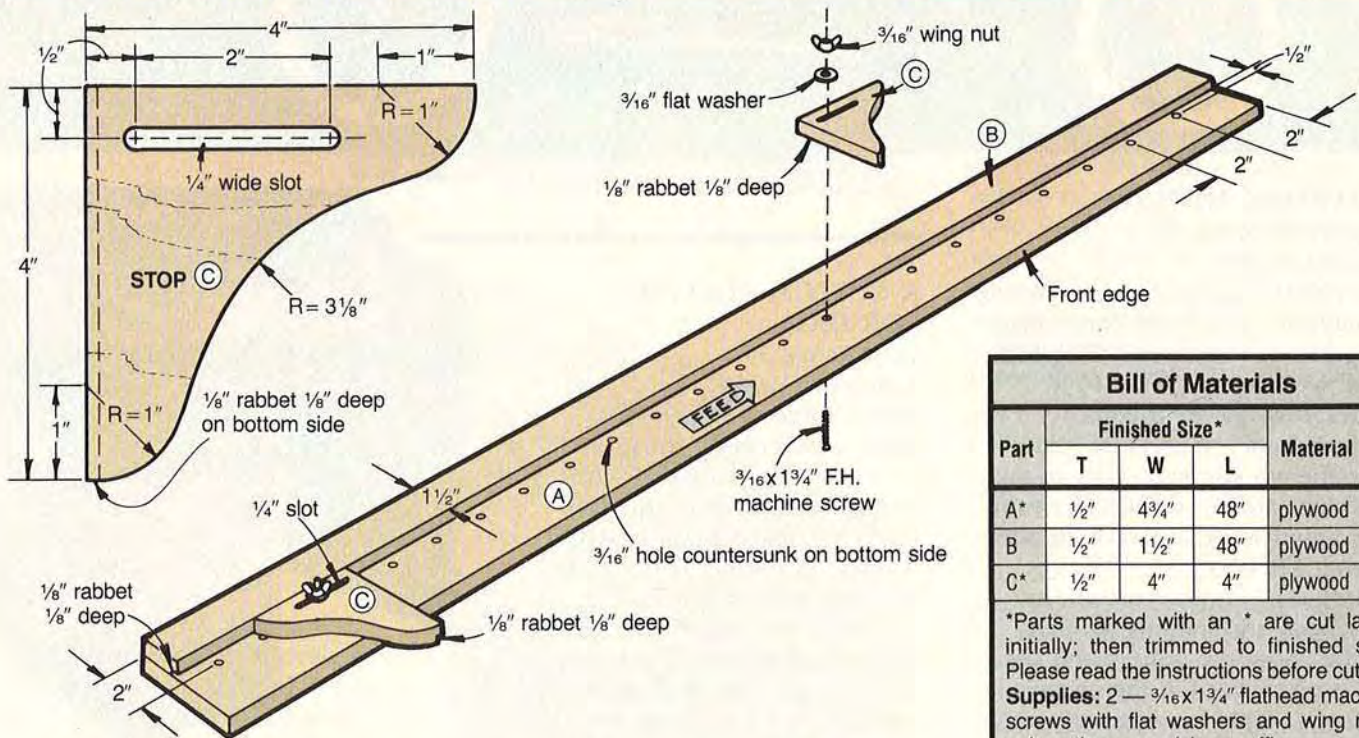

Bill of Materials					
Part	Finished Size*			Material	Qty.
	T	W	L		
A*	1/2"	4 3/4"	48"	plywood	1
B	1/2"	1 1/2"	48"	plywood	1
C*	1/2"	4"	4"	plywood	2

*Parts marked with an * are cut larger initially; then trimmed to finished size. Please read the instructions before cutting.
Supplies: 2 — 3/16 X 1 3/4" flathead machine screws with flat washers and wing nuts, polyurethane varnish, paraffin

For stopped dados, determine the length of the dado needed, position the stops, and tighten the wing nuts to hold the stops to the base. Position the straightedge on the workpiece and clamp it in position. Hold the router subbase against the guide but at a slight angle so the bit does not contact the piece to be routed. Start and

lower the router to gently "plunge" the bit into the workpiece. Push the router from one stop to the other to rout the stopped dado. If available, a plunge router works great for stopped dados.

If you don't have a jointer and need to **edge-joint** irregular boards, remove the stops and clamp the front edge of the

straightedge to the board being straightened so a minimum of 1/16" of the irregular edge protrudes the entire length of the board. Using a straight bit, rout the irregular edge of the board straight. 🌲

Project Design: James R. Downing, Jim Boelling
 Photographs: Jim Kascoutas
 Illustrations: Kim Downing, Bill Zaun

READERS,
IT'S YOUR
TURN!

PROJECT

We're often surprised at the directions woodworking takes. The vintage "woodie" here is but one example. Our other projects prove to be a little smaller, though no less skillful.



TRAVELING IN STYLE

*Gregory Thomas, 33
Manitowoc, Wis.*

Apprentice commercial electrician
Though he's a diehard Chevy man, Greg couldn't resist restoring this Ford "woodie" wagon, a 1930 Model A owned by friends.

Three hundred and fifty hours later, the woodie was ready to take first place at auto shows. Her value rose significantly, too — with offers of over \$20,000.

Greg used another woodie to copy body and framing patterns, and he chose the same wood species used by Ford in the original woodies: maple framing with birch plywood panels and birch strips across the top. Floorboards are white oak. All wood parts were glued and screwed together and the framing bolts to the chassis. Valspar gloss plastic coat gives the wood protection and a high shine.

With the woodie behind him, this craftsman is content to build an occasional dashboard — leaving more time for his '32 Chevy coupe.

 [Print this article](#)

A CUSTOM ROLLTOP FOR DAD

*Scott Keller, 25
Arlington, Va.
Cabinetmaker*

Scott only recently became a cabinetmaker. His woodworking, though, goes back to the days when he tagged along to work with his bricklayer father and "helped" the carpenters.

It turns out that Scott's father did himself a favor by bringing Scott along: This solid cherry rolltop desk was a gift from his son, who put 160 hours into it. Without plans, Scott simply measured another rolltop for basic dimensions. Then, he made a practical adjustment to the measurements.

While the model measured 45x47x30", Scott made his only 28" deep so that it could be moved through interior doorways. To make the mortise-and-tenon-jointed, 200-plus-lb. desk even



more manageable, he built the top as a separate unit. And, he added a surprise: When the top rolls up, a switch depresses to turn on the desk light inside.

Scott applied a light coat of golden oak stain to pick up the grain. He finished the desk with seven coats of polyurethane.

A well-thought-out plan, Scott!

SHOWCASE

A CHALLENGE MATCH

Sean McClure, 14
Orem, Utah
Student

Sean likes a challenge. He describes the chessboard he made of ebony and satinwood squares as his "first challenging project, after yo-yos

and birdhouses." Because Sean plays tournament chess, the board fit his game plan perfectly.

Sean's woodworking interest comes naturally: His father is Paul McClure, wood technology consultant for *WOOD Magazine*. Dad helped Sean some, but only because the table saw was off-limits. Young McClure did the rest, and he told us precisely how. Sean even routed a V-groove between the squares, but says the moldings were the hardest:

"First, I routed the edges of a purpleheart board with Bosch's 1/2" classical bit. When I ripped the edges off, there were my moldings. Then, I made a rabbet in the back of the moldings, mitered the ends, and glued them to the board. After I put the purpleheart on, I made the ebony moldings exactly the same way, only I used Bosch's 1/2" cove bit. They went on the same way, too. To fill the cove in the ebony, I cut a strip of primavera veneer and glued it in."

Sean finished his board with three coats of clear Deft. We only hope his chess game continues to match his shop skills! ♣

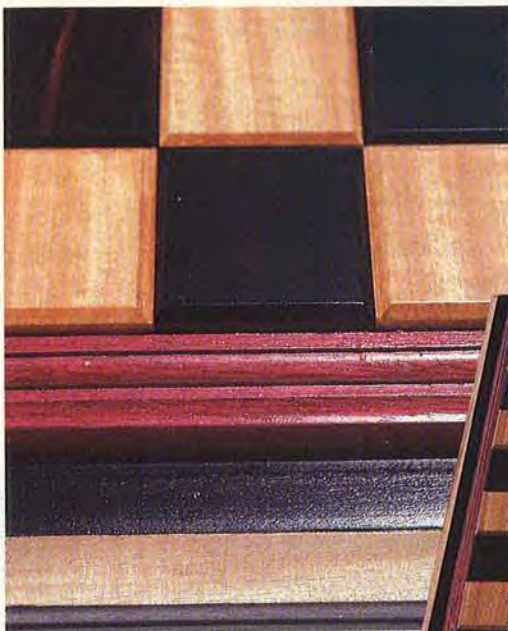

A RICH LOOK

Rich Goldman, 34
St. Louis, Mo.
Structural engineer

Rich both builds and designs. He and his wife searched in vain for a coffee table that "looked somewhat Danish modern, yet was rustic enough that it didn't say 'don't touch me,'" Rich recalls. Together, they designed this fluid-lined, butcher-block-style table measuring 60" long, 23" wide, and 16" and 12" high.

For an eye-catching effect, Rich alternated the grain of white pine strips (top grain, then edge grain). He stained the table walnut

and, sanding with wet or dry paper between coats, applied satin-finish polyurethane.

Joints are 3/4"x3/4" tongue-and-groove. For load-bearing strength, this structural engineer used #8x1 1/2" wood screws placed at 90° angles from each other.

TO SUBMIT YOUR PROJECTS...

Send a 35-mm color slide (no prints, please), with the project as the focal point and a simple background — no people. Include a capsule description — materials, special joinery, finish, and dimensions, for example. *WOOD* will pay \$25 for published projects. Slides cannot be returned unless you enclose a self-addressed, stamped envelope.

Project Showcase
Better Homes and Gardens®
WOOD Magazine
Locust at 17th
Des Moines, IA 50336



 Print this article

MAKE 'EM IN A DASH SHAKERS

Spice up somebody's table setting with these palm-sized mahogany and walnut shakers. They're nice to look at, nice to handle, and you can turn them out quicker than a wink.

1 Rip and crosscut parts A, B, and C to the size listed in the Bill of Materials. For part B you need $\frac{1}{8}$ " walnut stock. You can either resaw and sand thicker material to $\frac{1}{8}$ " or special-order (see the Buying Guide for our source).

2 Using the Side-View Drawing as a reference, glue and clamp the walnut and mahogany pieces into

two equal-size stacks, keeping the edges flush. We alternated the grain direction of each layer, as shown in the Side-View Drawing, for stability and eye appeal.

3 After the glue has dried, scrape off the excess. Find the center point on the top of each lamination by marking diagonals from corner to corner. (Although it's not essential, we used a band saw to cut the laminations to rough shape prior to turning them.)

4 Mount one of the walnut and mahogany laminations on the lathe with the walnut against the tailstock. (We mounted each lamination between centers, as shown in the photo on the opposite page.)

5 Using a large gouge, round-down the laminated block to the largest cylinder size possible. (We started with a sharp gouge to ensure a good cut and minimal chipping.)

6 Bore a $\frac{3}{4}$ " hole through a piece of $\frac{3}{4}$ " scrap material (this board will serve as a mounting block later when the holes are being drilled in the shakers). Now, lay out the tenon (walnut end of the block) and turn it down to $\frac{3}{4}$ " diameter with a parting tool.

Check the diameter with a pair of outside calipers as you turn it down. At just a hair over $\frac{3}{4}$ ", stop the lathe, slide the tailstock and turned stock away from the live center, and check the fit of the

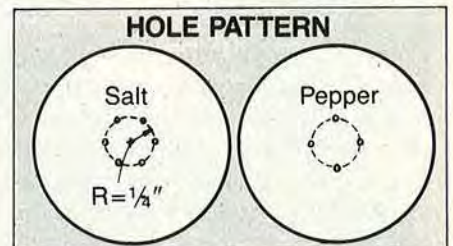
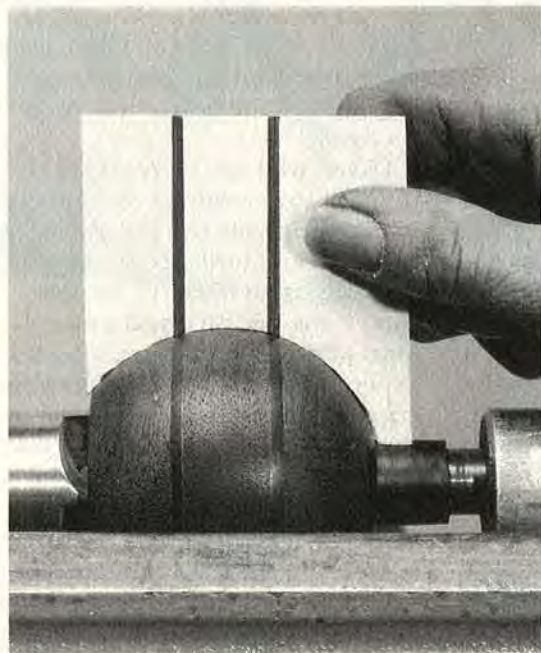
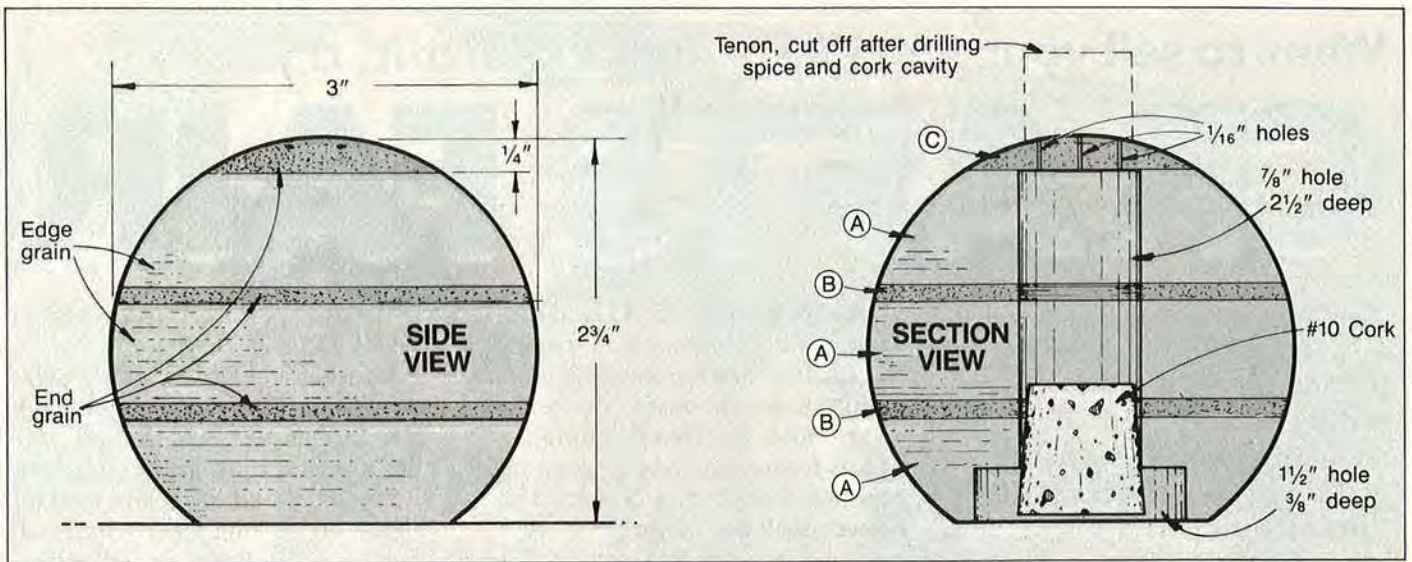

Bill of Materials For Two Shakers					
Part	Size			Material	Qty.
	T	W	L		
A	3/4"	3/4"	3/4"	Honduras mahogany	6
B	1/8"	3/4"	3/4"	walnut	4
C	3/4"	3/4"	3/4"	walnut	2

Supplies: polyurethane, two #10 corks that taper from 1" to 3/4" (available at most hobby stores and some hardware stores)

tenon in the 3/4" hole you bored in the mounting block. Turn until the tenon fits snugly in the hole.

7 Using a piece of cardboard or hardboard and the Side-View Drawing as a reference, outline the profile of the finished shakers on it. Cut the profile template to shape.

8 Turn the stock down to about 1/16" over size, stopping the lathe periodically and checking the shape with the template as shown in photo above. (We marked lines on the template to correspond with the walnut stripes in the shaker for a more accurate contour.) Finish-sand the shaker to size.

9 Remove the shaker from the lathe and fit the tenon in the 3/4" hole in

the mounting block. Center and clamp the shaker and mounting block to the drill press (see photo above). Using a 1 1/2" flat-bottomed bit (we used a Forstner), bore a recess 3/8" deep in the nearly completed shaker. Without moving the shaker and mounting block, change to a 7/8" flat-bottomed bit and drill to a depth of 2 1/2".

10 Remove the shaker from the mounting block and drill press, saw off the tenon, and sand the top end to shape. (When cutting the tenon off the end, we left on about 1/8" of the tenon, and then sanded the top to shape.)

11 Repeat steps 4 through 10 to fashion the other shaker.

12 Lay out the hole pattern on the top of each shaker and drill 1/16" holes (see the Hole-Pattern Drawing for help with this).

13 Apply several coats of finish, being careful not to clog the holes. (We finished ours with polyurethane to minimize the difference in color between end and edge grain.)

BUYING GUIDE

• 1/8" walnut. 1/8 x 5 1/2 x 18". \$3.36, catalog no. W4601. Craftsman Wood Service, 1735 W. Cortland Ct., Addison, IL 60101 (312/629-3100). 🌲

Project Design: James R. Downing
Photographs: Hopkins Associates
Illustrations: Bill Zaun

Want to sell your work? For fun and profit, try a...

CRAFTS FAIR!

Many woodworkers finance their favorite pastime, as well as travel, by selling at crafts fairs. If that's something you've been dreaming about, here's the information you need to get started.

Compared to all other ways of selling, crafts fairs give you an opportunity to sell a lot of your work at one time for full price. When you throw in the extras — like travel and having fun meeting other craftspeople and viewing their work — it's easy to see why crafts fairs have become so popular.

Selling direct at crafts fairs also means meeting the public, and discovering first-hand what they think of your products — both the good aspects and the bad. There will be plenty of work involved too, in packing, transporting, unloading, setting up, selling, and tearing down. For all this, those who regularly sell at crafts fairs will tell you there's no guarantee of success. Yet, each year thousands of woodworkers and other craftspeople find crafts fairs just the ticket for selling their work, and they have fun, too.

CRAFTS FAIRS OF ALL SIZES

Club and church bazaars represent the smallest and simplest type of crafts fair. At the other end lie the giant, three- and four-day-long events frequently held in posh metropolitan convention centers. In between fall the majority — the one- and two-day fairs usually held outdoors in summer, with anywhere from 25 to maybe 500 exhibiting craftspeople.

More and more shopping malls host fairs on weekends. (For sources that list these and other fairs, see the box at the end of this article.)

All crafts fairs fall into one of two categories: *juried* or *non-juried*. A juried fair has judges who review slides of your work and either accept or reject it for entry based on their criteria for craftsmanship, originality, and suitability for that particular fair. You need to submit entries to juried fairs months in advance, complete with a \$10 to \$25 non-refundable jury fee.

Most non-juried fairs operate on a first-come, first-served basis. Occasionally they'll set limits on the number of craftspeople selling any one media (wood, ceramics, prints, watercolors, or weaving).

HOW TO SELECT A CRAFTS FAIR TO ATTEND

Because crafts fairs not only differ in size, location, and attendance, but also in management, amount of promotion, and type of clientele, there's no well-defined, tried-and-true technique for picking a fair where sales will be good. Experienced exhibitors, however, such as David DiZinno, of Wellington, Ohio, have developed working guidelines that help increase their chances of sales success.

David, who for 18 years has traveled to as many as 35 crafts fairs a year selling his wood mosaics, prefers to attend juried fairs. "These fairs emphasize quality," he says. "And if the fair isn't held in a cultural wasteland, the buyers come expecting to pay for it. Serious buyers usually want to see and talk to the artist or craftsperson who made the work. Size makes little difference. You can still make good money at a small crafts fair. It's the people attending that count."

Over the years, David says he has learned to spot the types of people who'll likely buy his work. "They look well-dressed, and typically ask intelligent questions."

Woodturner Cleat Christiansen, from Ogden, Utah, sells at 16 fairs a year from coast to coast. In the 4½ years he's been attending fairs, he's also come to limit himself to only juried fairs. "If you're going to travel any distance at all, you might as well go where the money is," he advises.

Even juried fairs prove chancey, though, since you can't count on being "juried in" from one year to the next. But, as Frank Garvelink, a Marcellus, Michigan woodworker says: "Crafts fairs are like the stock market; you learn to run with the blue chips." In his 12 years of marketing band-sawn baskets, he has sold at up to 30 crafts fairs a year.

Business cards passed out at crafts fairs can lead to future sales.

John T. Burke
Woodworker

1912 Lexington Dr.
Woodland, N.Y. 00000
Phone: 712/555-1100
712/555-2390

Handcrafted
wooden toys and
accessories for
the home

 Print this article



Although juried fairs seem to be preferred by many craftspeople, don't let that stop you from trying a non-juried fair. One, or several, might work for you.

Even with this advice under your belt, there are still hundreds of juried, and many non-juried, fairs to pick from. So where do you turn next? To fellow craftspeople and artists who regularly make their way around the crafts fair "circuit." Word-of-mouth recommendations from folks who have been to a good fair even helps out the pros.

"I talk to all kinds of crafts- men and -women — painter's, jewelers, potters. Anyone who does work in the same class or level as mine can tell me what I might expect at an untried fair," David tells us. "I might get 10 opinions, then take the consensus."

The monthly magazine, *Sunshine Artists U.S.A.*, lists hundreds of fairs by state (see source box at end of article) and provides additional information on entry fees, types of work featured, and where to write. It also rates recent fairs, tells what sold best, and gives pertinent com-

ments of interest to exhibitors. The woodworkers we talked to rely on this reference to supplement their other information.

They also agree with these guidelines to use in selecting a crafts fair:

- Crafts fairs associated with celebrations and festivals often draw fun-seekers rather than buyers.
- Check a fair's pedigree. Local arts and crafts councils, civic organizations, or culturally related groups usually sponsor quality shows with a buying crowd.
- Shopping mall crafts fairs can bring in lots of traffic, but the hours (typically 10 a.m. to 9 p.m.) can be grueling. And, these fairs are usually held in the off-buying months of April and October, rather than during the summer or around major gift-giving holidays such as Mother's Day or Christmas.
- One-day fairs can be profitable, but you might as well choose a longer fair to make it worthwhile.
- Look for longevity. First-time fairs may be a gamble if you don't know the area's buying potential.

- Check out the economic climate where the fair will be held. A local industry layoff, for example, could mean less money for spending.

After you've done your homework, try visiting a few of the crafts fairs you'd like to enter in the future. You'll get a feel for the buying atmosphere, and actually see what's selling at the time. "Even then," remarks Cleat, "you won't know for sure that your things will sell until you do the show."

WHAT IT COSTS TO SELL YOUR WORK

Small bazaars normally charge only a token fee for a table, but expect to pay \$50 to \$75 for an 8x10' or 10x10' space at an average-sized, two-day crafts fair. Some will cost as much as twice that; others, less. As noted before, juried shows also charge a non-refundable jury fee to evaluate your products.

You'll need a booth or display with signs. For a first-time fair

Continued on page 86

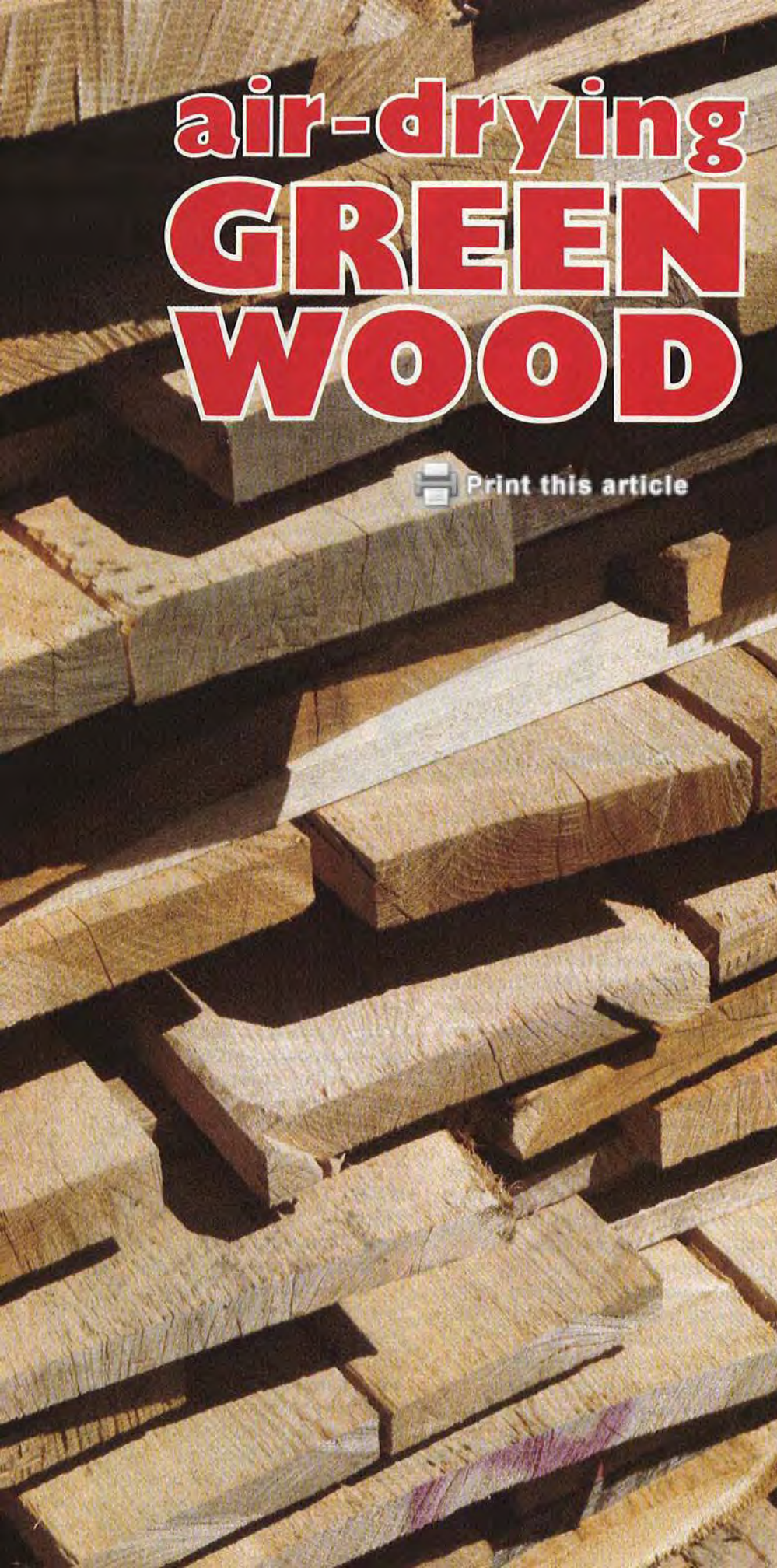

air-drying **GREEN WOOD**



Print this article

Drying green wood with pile up with the lumber: from wood stock you've

Air-dry your own stock? Why not? Many woodworkers do and so can you.

If you harvest the wood and saw it yourself, all you'll have invested will be your time, labor, and pocket change — providing you already own the equipment.

You'll save at least 50 percent over the retail price of good, kiln-dried hardwood by buying green logs and having them custom-sawed at a mill for 15 to 30 cents a board foot. Even if you purchase green, fresh-sawed boards from the mill (at about 50 cents per board foot more), you'll come out ahead. And if you're patient, understand the principles, and adhere to time-tested technique, you'll have top-quality wood for your projects. Some craftsmen swear air-dried stock works better, and looks richer in color when made up, than the kiln-dried variety.

GREEN WOOD: HOW WET IT IS

Depending on the species, the moisture content of green wood normally ranges from 40 percent in heartwood to as much as 70 percent in sapwood. Once a tree has been felled, the wood starts drying out, and continues drying until its moisture content balances with the relative humidity of the air surrounding it. At this stage, we call it "seasoned."

But even seasoned wood, like a sponge, can absorb or lose moisture. Depending on the species, this may take a few days or a few weeks. A finish simply slows the process down. While you'll never completely prevent wood from changing its moisture content, you can control to some degree how much it fluctuates.

You want to dry the wood to a moisture content equal to the average relative humidity of the place where it will eventually be used. In most cases, that'll be inside your home.

Mother Nature's help alone takes time and effort, but your rewards Besides saving a bundle, you'll take extra pride in projects made processed yourself.

For most of us in the U.S., that means seasoned wood should have a working moisture content of about eight or nine percent: in very humid areas slightly higher; in dry parts of the country, slightly lower. You can call the nearest National Weather Service office for average relative humidity where you live. If your home is humidity-controlled, contact your local heating and cooling dealer for this information.

When naturally seasoned wood reaches the desired moisture content, it remains as stable as any other stock you've worked, provided it won't be subjected to extreme dryness or wetness.

BEFORE YOU BEGIN DRYING: TIPS FOR SOUND, SEASONED STOCK

Green wood shrinks as it dries. That's a fact you can't escape; but you *can* control the rate. Stress from too rapid moisture loss causes wood movement that produces cracks, checks, and warpage. To prevent such problems you slow down the drying process, but not so much that the wood becomes susceptible to moisture-related fungi growth that will stain, mold, and lead to decay.

The key: properly locating and carefully building the stack. On the following pages you'll learn the right way to lay up your lumber. But even before you start, there are some things you can do to ensure good results.

- **Select only straight-grained boards with minimal defects.** Boards with knots and sap pockets tend to check and warp more than clear, defect-free lumber. Figured wood, with uneven grain patterns, will check more than unfigured wood.

- **Stock 1" to 2" thick air-dries best.** Thinner boards warp when stacked; thicker ones dry too slowly and unevenly.

- **Start with check-free wood.**

End grain dries 10 times faster than other surfaces, so expect some checking on board ends. You can minimize loss to checking by cutting off any checked ends before drying, then coating the newly exposed wood with a sealer. Use aluminum paint, roofing cement, or a commercial sealant such as Mobilicer-M or Sealtite 60, available from woodworking supply dealers. Or, you may do what sawmills do — leave about 3" extra length on each end of the board for trimming later.

- **Don't try to dry boards wider than 12".** Wide boards cup more than narrow boards because wood shrinks more in width than length.

- **Allow for shrinkage and surfacing.** If you don't plan to seal the ends, rough-saw the boards at least 1/8" thicker and wider, and 6" or so longer.

HANDLING THICK STOCK

Thick, short carving blocks, bowl blanks for wood turning, slabs, and chunks from short sections of log pose special problems if air-drying because they *are* thick.

For best results with these, split them out from the section of log and cut out the pith (central core of the log), as shown above *right*. Then, either seal *all* sides to slow down the moisture loss, or wrap the piece tightly in a double-layer of newspaper and tape all seams (the newspaper *slowly* wicks away moisture). Place the sealed or wrapped wood in a warm, dry area where air can circulate around it (on stickers or across rafters), and weigh it periodically. When it stops losing weight, the wood has dried.

The time it takes varies with the wood, the thickness, and the method, of course, but a 2'-long, 6"-thick chunk of basswood wrapped in newspaper may dry in a month. Unwrapped, sealed wood may take three months or more.

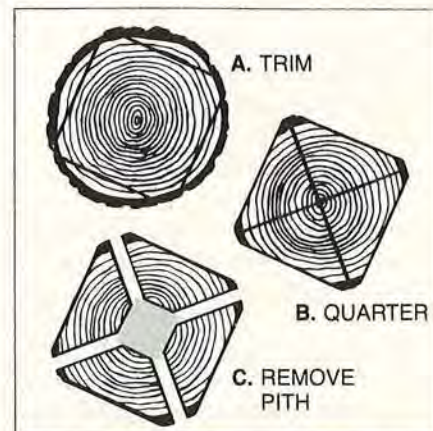

To make smaller but unsawed pieces (called *flitches*) from a log section, first trim away the bark from the sides, and, if you want, square them up (A). Next, quarter the log with two cuts (B). Then, split out with the pith (shaded area in C).

HOW TO TELL DRY WOOD

Relying entirely on the old adage "one year of drying time per inch of thickness" to gauge dryness may work for some very thick wood, and for some people in some places. But you'll need more accuracy for quality, air-dried stock. In many cases, that "one year" might actually be too long a time.

According to guidelines established by the U.S. Forest Service's Forest Products Laboratory, in Madison, Wis., you can air-dry many hardwoods outdoors to 15-20 percent moisture content in 45-60 days. That's in sunny, temperate, not too humid, weather — late spring to early summer and late summer to mid-fall if you go by the seasons.

To lower the moisture content below 15 percent, you have to move the wood to a heated room approximating the humidity and temperature of where you plan to use it. For this final drying, the wood must be restacked with stickers just as it was outside.

To know what's happening, experts recommend you check your wood's moisture content

Continued

all through the drying process with a moisture meter. Or, you can use the "oven-dry" method explained below.

MEASURING MOISTURE CONTENT WITH THE OVEN-DRY METHOD

Select a sample board, representative of the thickness and type of wood you're drying, from close to the middle of your lumber stack. From it, crosscut a 1"-wide piece about 2" from one end. Avoid knots or other defects. Weigh the test piece and record its weight. Place the piece in an oven set at 215°F. and check it periodically until it no longer loses weight (usually about 24 hours).

Subtract the sample's weight after oven-drying from its initial weight to find the weight of the lost moisture. Then, divide the moisture weight by the oven-dry weight to find the percentage of moisture content your wood has at that stage.

Here's an example: A piece of wood weighs 10 ozs. before drying and 8 ozs. after. The 2-oz. difference represents the weight of the lost moisture. Dividing 2 by 8 gives you .25, or 25 percent moisture content.

You can use the sample board to cut test pieces from throughout the air-drying process. When the wood reaches the moisture content you need, it's ready to work.

But don't stop yet. Dry wood, unless it's stored with care, can reabsorb a lot of the moisture you've already removed. After air-drying outdoors, don't move the wood into a high-humidity basement, for example. Remember, the temperature and humidity of the room where you store it should be about the same as where you'll use the wood.

Wherever possible, store lumber flat to avoid warping from its own weight. If you can't, keep the boards as near vertical as possible in an upright rack to avoid bowing.

If you have room for flat storage, sticker the boards to allow air circulation under and through them.

HOW HUMIDITY AFFECTS DRY WOOD

It may take as long as two weeks, but dry wood will always balance its moisture content with the relative humidity, as shown in the graph, above *right*. Scientists call this phenomenon *equilibrium moisture content* (EMC).

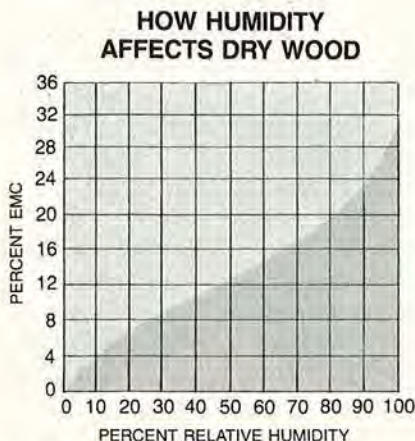

SEASONING SECRETS: THEY'RE IN THE STACK

Seasoning green wood may be extra work, but worth it. The traditional way calls for stacking the pile carefully, separating each board from the one above and below it with 1x1" wood strips called *stickers*. The boards must also be separated from their neighbors in each layer by a 1" air space.

Many consider a 4x8' pile ideal size because a sheet of plywood can be used for protection on top. Stability of the stack governs how high you build it.

Where you site the stack, how you lay down the boards, and the way you protect them, become just as critical as drying time.

Choosing a site

Furniture and cabinet stock should dry slowly to minimize defects. That's why you need to select a pile site *before* you bring the wood home — so you can sticker and stack the wood immediately.

Avoid damp, boggy areas, overhanging trees that drop leaves and twigs, and the sunniest spot in the yard. Face one end of the pile into the prevailing wind.

If you can build the pile inside an open barn or shed, the wind and weather won't be problems. But in an enclosed space, such as a garage or attic, you may need to install a fan to circulate air.

Build a solid foundation

Our lumber pile, illustrated *right*, has a typical foundation for a 4x8' stack built up to 6' high.

To keep ground moisture from infiltrating the lower layers, first put down some polyethylene sheeting or asphalt roofing felt. On top of the moisture barrier, set concrete blocks to support the two long 4x6" beams called *mudsills*. Together, the mudsills and concrete blocks keep the bolsters and bottom boards of the pile at least 1' off the ground, away from any possible water or mud damage.

To avoid any bowing and warping an uneven pile might cause, the 4x4" bolsters, or crosspieces, must be level with each other and an equal distance apart. Use a long, straight board or a mason's line to check alignment, and shim to level if necessary. (Note: Your pile can have a slight downhill slope.)

Sticker and stack with care

Have enough stickers on hand to support all your lumber. For each layer in a 4x8' pile, you'll need at least five stickers — one over every bolster, if you set them on 24" centers, and one on each end. If your boards sag a bit, reshuffle the pile and narrow up the bolsters to 16" centers. Careful, though, too many stickers impede airflow.

Always use clean, dry hardwood for your stickers. It's best to make them from the same species of wood you're drying. Otherwise, use birch, maple, poplar, white oak, or willow. Woods such as walnut and red oak tend to stain dissimilar woods.

To start the stacking, center your first layer of stickers directly on the bolsters, as shown. Next, lay down a layer of low-grade lumber to help shield the good wood from ground moisture. Now you can stack the rest of your boards, keep-

GREEN WOOD STACKED FOR AIR-DRYING

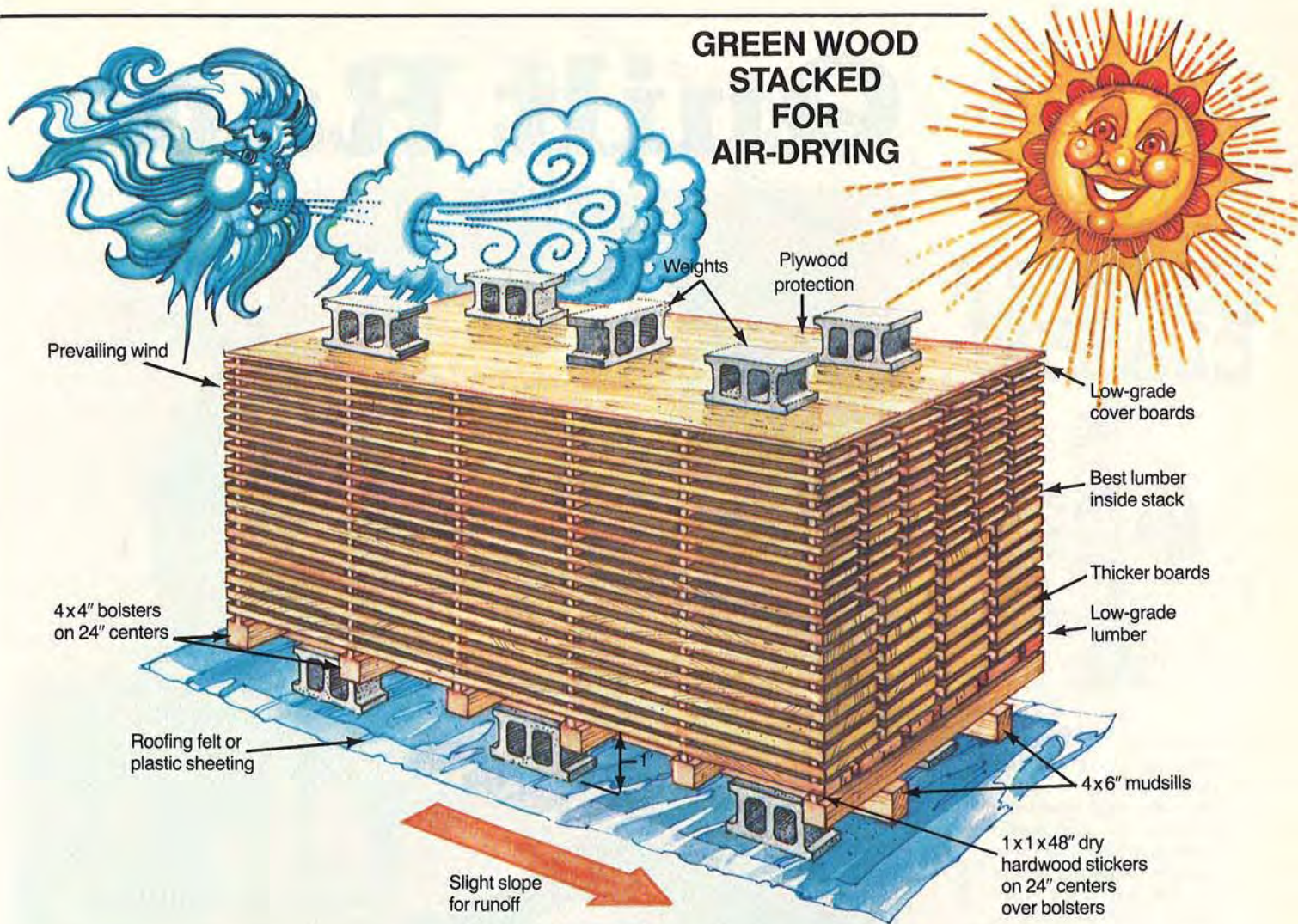

HOW LONG GREEN WOOD TAKES TO DRY

Drying days listed for the more popular hardwoods are minimum spring and summer days to arrive at a wood moisture content of 20 percent in 2"-thick stock.

HARDWOOD	DAYS TO DRY
Birch, yellow	75
Butternut	60
Cherry	72
Hickory	62
Maple, hard	55
Oak, red	78
Oak, white	85
Walnut, black	75

ing the stickers aligned and allowing about 1" of space between each board in a layer. Make certain all boards in the same layer are the same thickness.

Since thick boards tend to check or warp if dried too quickly, place them in the lower third of the pile. There, they'll dry more slowly.

Protect your drying wood

Top off the pile with a layer of lower-grade lumber, then cover it with plywood — stickered, of course. This protects your good boards from direct sunlight, rain, and snow. A stack in an area exposed to sunshine most of the day may need to have the sides shaded with light canvas or other woven material that "breathes."

Use bricks, cement blocks, or stones to weight the pile and keep the cover in place.

Maintaining the stack

Providing you've taken all the precautions in stock preparation, sitting and building the foundation, and laying up the boards, there'll be little to do except keep debris clear while you're waiting. You'll also need to keep your eye out for "wild" boards that in warping, may throw the pile out of kilter. If that happens, remove the outlaw board and restack.

Check the drying rate visually. Look for excessive checking or warp, which means wood is drying too quickly and needs more protection from wind and sun. Spotting the dark stains of mold and fungus indicates too slow drying, and calls for opening up the pile to more sun and wind. 🌳

Written by Jim Barrett and Peter J. Stephano
Photograph: Peter J. Stephano
Illustrations: Jim Stevenson

Quilt Rack

CRAFT A COUNTRY CLASSIC



Cold drafts snaked through homes like clouds through a mountain pass. And when the logs in the old wood stove died down to mere embers in the wee hours of the morning, one didn't want to have to venture too far across a cold floor for an extra quilt or feather tick. There was no handier place to store that needed warmth than on a quilt rack next to the bed.

 Print this article



Share the beauty of treasured handiwork or a hand-me-down heirloom on this distinctive quilt rack. Practical and attractive, it fits nicely into most home decors.

FORMING THE END SECTIONS

1 To form the arches (A), cut two pieces of $1\frac{5}{16}$ " oak — often called $\frac{9}{4}$ (six-quarter) stock — 9" wide by 14½" long. (We edge-joined narrower stock to make the 9" width.)

2 Using double-faced tape, stick the two arch blanks together face to face. Run the bottom edge of the arches over a jointer until the two are flush.

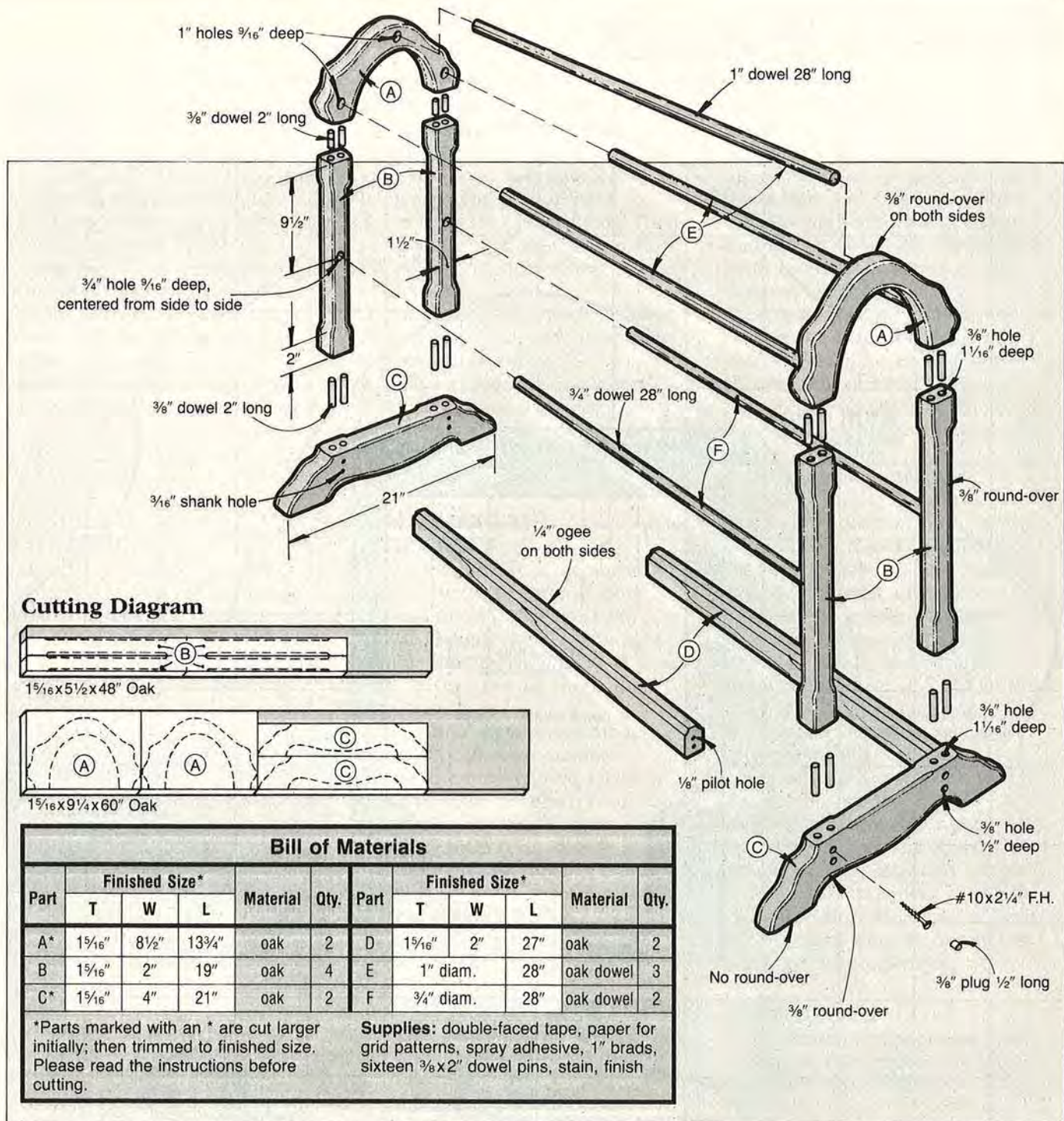

3 Draw a 1" grid measuring 9 x 14" on a piece of paper. Lay out the shape of the arch on the grid, using the Arch Grid on page 70 as a guide. To do this, mark the points where the arch outline crosses each grid line. Then, draw a line to connect the points.
 Mark the center points for the 1" dowels (E) onto the grid. Apply

spray adhesive to the back of the grid, and stick it to the arches. Position the grid so the bottom edge aligns with the bottom edge of the arch blanks.
4 With a scratch awl, indent the wood at each dowel center point on the face of the pattern. You'll use these points to locate and drill the 1" dowel holes later.

5 Cut the arches to shape (cut the top scrap in one piece and save it for use in clamping the end sections together later). With the arches taped together, sand all contoured edges flush with a drum sander. Remove the paper pattern and separate the two pieces.
6 Cut four pieces of 1 5/16" oak to 2 x 19" for the uprights (B). Now,

Continued

Quilt Rack

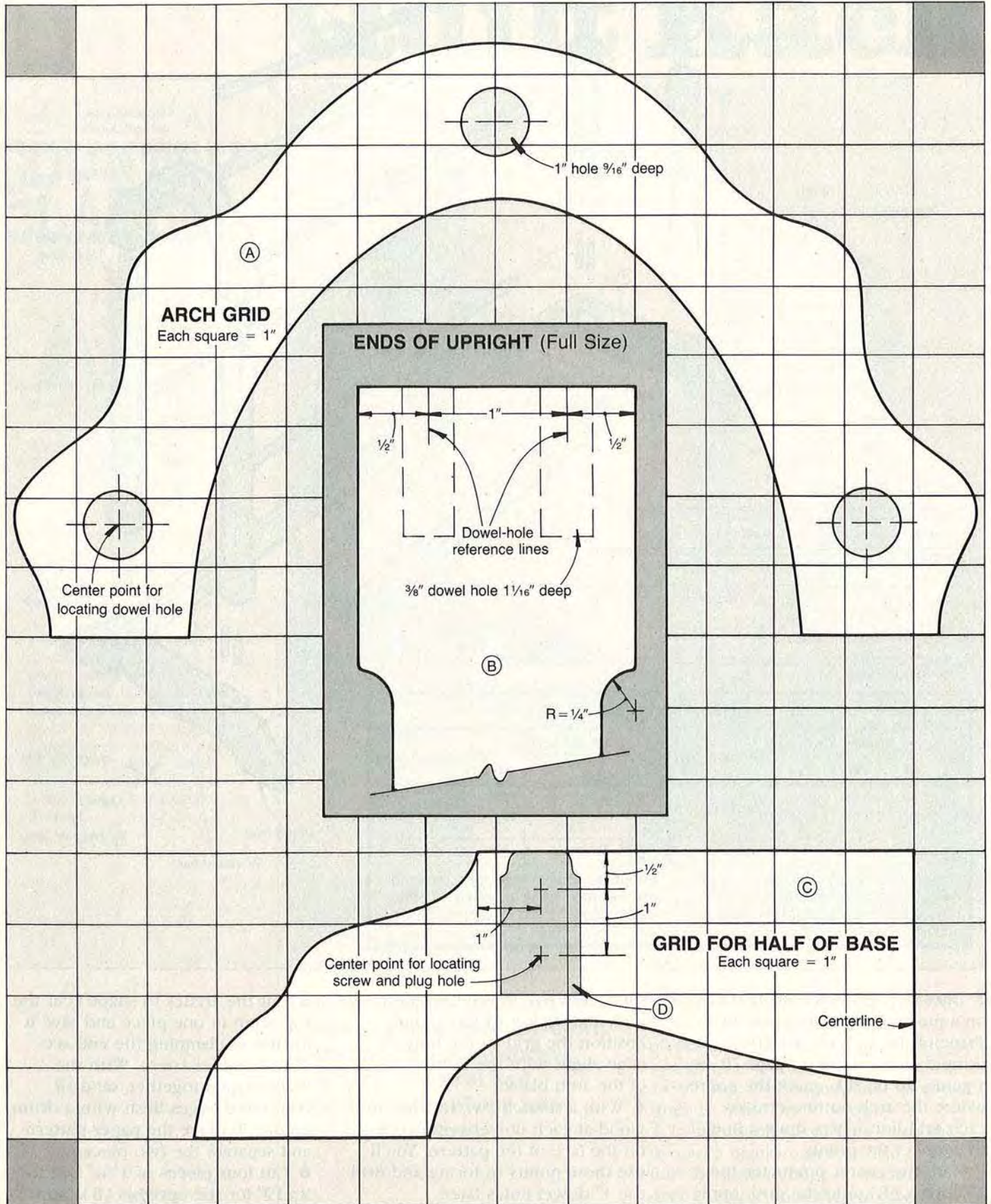

using the full-sized drawing at *left*, lay out the $\frac{1}{4}$ " radii and dowel-hole reference lines on each end of the uprights. Cut and drum-sand the uprights to shape. Using the dimensions on the Exploded-View Drawing, mark the dowel-hole center points for each $\frac{3}{4}$ " dowel on the inside face of two of the uprights. Keep these two marked uprights together to assemble in the first end section later.

7 Using the same techniques as described in steps 2 through 5 and the grid drawing at *left* as a guide, lay out, cut, and drum-sand the two bases (C) to shape.

ASSEMBLING THE END SECTIONS

1 Dry-clamp each end section together. As shown in the photo *below*, transfer the dowel-hole reference lines from the ends of each upright onto their mating arch and base pieces. (We used the scrap cutout from the top of each arch



and the bottom of each base as straight edges to clamp against.) Labeling the mating pieces at each joint also helps speed up assembling each end section later.

2 Unclamp the end sections. Then, using a doweling jig, drill a pair of $\frac{3}{8}$ " holes $1\frac{1}{16}$ " deep where marked at each joint.

3 Cut sixteen $\frac{3}{8}$ " dowels 2" long. Now, glue, dowel, and clamp each end section together.

4 Sand each end section smooth. Rout a $\frac{3}{8}$ " round-over along all edges *except* the feet of the bases where shown on the Exploded-View Drawing.

ASSEMBLING THE QUILT RACK

1 Cut the two cross members (D) to size. Next, cut three 1" dowels (E) and two $\frac{3}{4}$ " dowels (F) to finished length (28"). If you have trouble finding oak dowels in your area, see our Buying Guide for a mail-order source.

2 Rout a $\frac{1}{4}$ " ogee along the top edges of both cross members.

3 Snip the head end off a 1" brad, and chuck the brad into your drill. Using the brad as a bit, drill $\frac{1}{2}$ "-deep holes (one in each of the two uprights and three in one of the arches) on the center points marked earlier.

Snip the ends off five similar-sized brads so the brads are $\frac{5}{8}$ "

long. Insert a brad in each hole you just drilled. Place the second end section inside face down on top of the other end section. Align the bottom and side edges. Press the two end sections together to transfer the dowel-hole center point locations as shown in the drawing *lower left*.

4 Separate the end sections and remove the brads. Finally, drill a 1" hole $\frac{9}{16}$ " deep for each 1" dowel (E) and $\frac{3}{4}$ " holes $\frac{9}{16}$ " deep for each $\frac{3}{4}$ " dowel (F) using the brad holes and indentations in each end section as guides.

5 Dry-clamp the quilt rack together with the dowels and cross members in position (note on the grid drawing that the top edge of the cross members aligns flush with the top edge of each base). Now, using the hole sizes shown on the Exploded-View Drawing, drill plug, shank, and pilot holes through each base (C) and into the ends of each cross member.

6 Glue and clamp the rack with all cross members and dowels in place between the end sections. Remove any excess glue after a tough skin forms. Fasten the cross members to the bases with #10x2 $\frac{1}{4}$ " flathead wood screws.

7 Plane a thicker piece of oak to $\frac{9}{16}$ " thick. Cut $\frac{3}{8}$ " plugs $\frac{9}{16}$ " long from the oak. Plug the screw holes and sand the plugs flush.

TRANSFERRING THE DOWEL CENTER POINTS

Dowel-hole reference lines

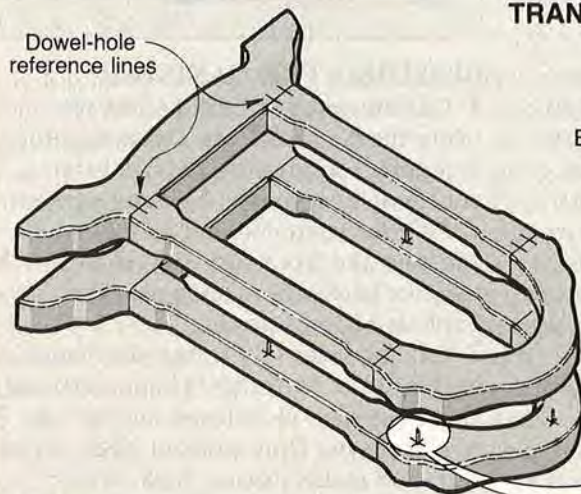

Brad with head clipped off, pointed end up

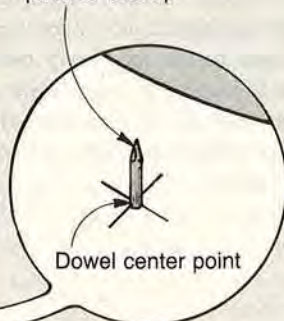

Dowel center point

FINISHING UP

1 Finish-sand and apply the stain and finish. (We applied a walnut stain and polyurethane.)

BUYING GUIDE

• **Oak dowels.** 1"-diameter dowel 36" long, \$2.30 each (3 needed). $\frac{3}{4}$ "-diameter dowel 36" long, \$1.90 each (2 needed). Plus \$2.50 handling. Woodworks, 4013-A Clay Ave., Fort Worth, TX 76117, or call 817/281-4447. 🌲

Project Design: Wes Gard
Photographs: Hopkins Associates;
Jim Kascoutas; Bob Calmer
Illustrations: Kim Downing; Bill Zaun

Kitchen Canisters

CRAFT A COUNTRY CLASSIC



The mill was a common gathering point in the fall. Farmers from far and wide would come to have part of their wheat harvest ground into flour. Hauled home in 100-pound sacks, a small amount of the flour was placed in a kitchen canister for convenience.



In Grandma's house the kitchen canisters sat at arm's length from the stove, brimming full of the ingredients she used in her daily cooking. These oak canisters will convey the same functionality and charm in your kitchen. And as a bonus, we've thrown in an easy-to-make brass scoop. See page 75.

 Print this article

CANISTER BACK

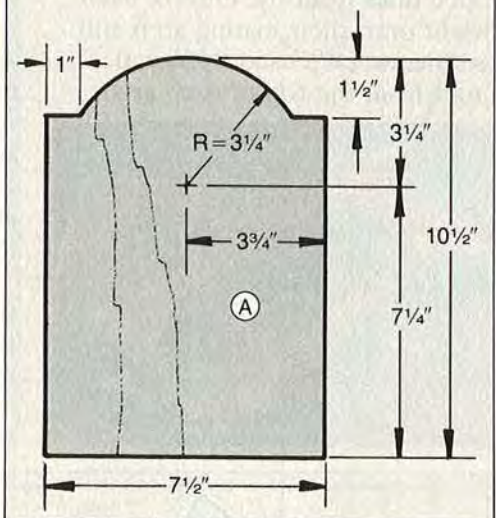

Note: The instructions explain how to make one canister, and the Bill of Materials gives the number of pieces required for one canister. Decide on how many canisters you want, and then cut and make as many parts as necessary. If making more than one, we suggest you cut all identical pieces at the same time to ensure uniformity and save time.

BUILDING THE CANISTER

- 1 Cut the canister back (A) to size. Using the Canister-Back Drawing above as a guide, lay out the radiused top edge, cut it to shape, and sand smooth.
- 2 Fit your router with a $\frac{3}{8}$ " cove bit, and rout the front top edge of the canister back where shown in the Exploded-View Drawing.
- 3 Cut the sides (B) to the size listed in the Bill of Materials. Then, mark and angle-cut each as follows: measure up $5\frac{7}{8}$ " from the front bottom edge of one side, and make a mark. Now, draw a line from the mark across the grain to

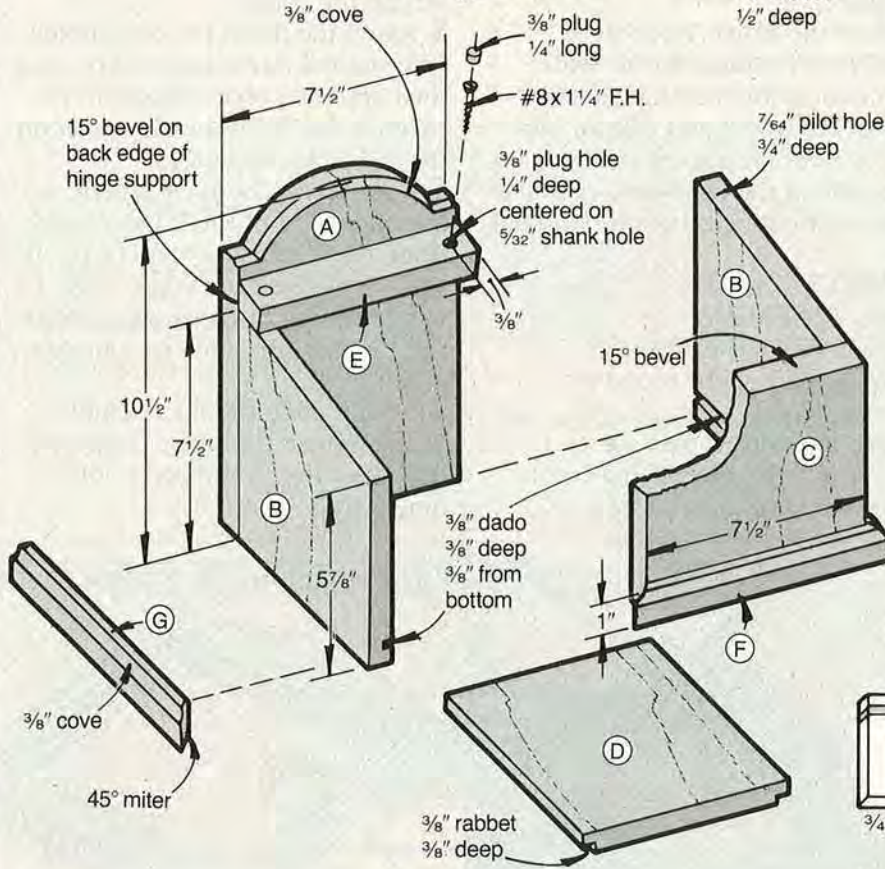
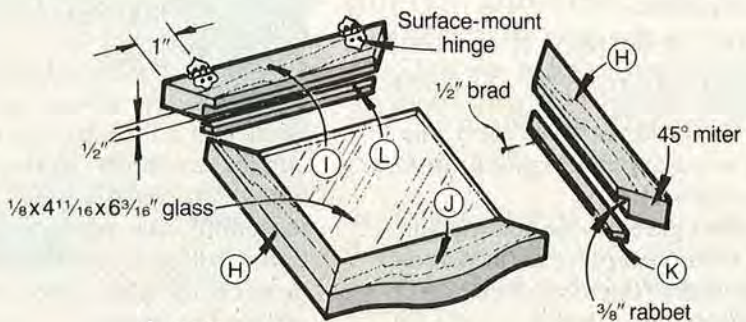

Bill of Materials For One Canister					
Part	Finished Size*			Material	Qty.
	T	W	L		
A	3/4"	7 1/2"	10 1/2"	oak	1
B	3/4"	6"	7 1/2"	oak	2
C*	3/4"	7 1/2"	5 7/8"	oak	1
D	3/4"	6 5/8"	6"	oak	1
E*	3/4"	1 1/4"	7 1/2"	oak	1
F*	1/2"	1"	8 1/2"	oak	1
G*	1/2"	1"	8"	oak	2
H*	1 1/16"	1"	6"	oak	2
I*	1 1/16"	1"	7 1/2"	oak	1
J*	1 1/16"	1 1/2"	7 1/2"	oak	1
K*	1/4"	3/8"	4 3/4"	oak	2
L*	1/4"	3/8"	6 1/4"	oak	2

*Parts marked with an * are cut larger initially; then trimmed to finished size. Please read the instructions before cutting.

Supplies: #8 x 1 1/4" flathead wood screws, 1/8 x 4 1/16 x 6 3/16" antique glass panel (available at stained glass stores), one 3/4" brad for use as a drill bit, 1/2" brads, polyurethane, salad-bowl finish

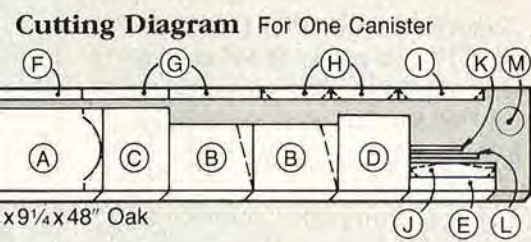

the top back corner. Align your radial arm saw blade with the marked line, and make your cut. You can also make the cut using a table saw and miter gauge. Repeat for the other canister side.

4 Cut the canister front (C) to size plus 1/4" in length. Tilt your saw blade 15° from vertical, and bevel-cut the top edge of the front to finished length (5 7/8").

5 Cut or rout a 3/8" dado 3/8" deep 3/8" from the bottom edge of each side piece where shown on the Exploded-View Drawing.

6 Cut the bottom (D) to the size listed in the Bill of Materials. Then, cut or rout a 3/8" rabbet 3/8" deep along each edge.

7 Dry-clamp the parts together to check the fit. The bottom should fit a bit loose to allow for expansion, especially across the grain. Check the beveled top edge of the front against the angled top edge of the sides; sand or trim flush if necessary. Remove the clamps. Now, glue and clamp the canister together. Do not glue the bottom (D) in the rabbet, it "floats" freely.

8 Cut the hinge support (E) to size plus 1/4" in width. Then, bevel-rip one edge at 15° to a finished width of 1 1/4". (For safety, we cut one long length for all the hinge supports; then bevel-ripped one edge of the length, and finally cut the pieces to finished length.)

9 Position and dry-clamp the hinge support to the canister. Now, drill the plug, shank, and pilot holes through the hinge support and into the sides (B) as dimensioned on the Exploded-View Drawing. Glue and screw the hinge support in place.

Continued

Kitchen Canisters

10 Plane a piece of scrap oak to $\frac{3}{16}$ " thick. Cut $\frac{3}{8}$ " oak plugs from the piece, and glue and insert them in the plug holes. Later, sand the plugs flush and the canister smooth.

FORMING AND FITTING THE TRIM

1 Cut and shape the base molding (F, G). (We cut an oak piece $\frac{3}{4} \times 1 \times 27$ " for each canister, and then planed it down to $\frac{1}{2}$ " thick.) Rout a $\frac{3}{8}$ " cove along one edge of the long piece. Miter-cut the front (F) and sides (G) to length.

2 Glue and clamp the molding pieces to the base of the canister. Remove any excess glue after a tough skin has formed. Later, sand the molding smooth. (To sand the coves, we wrapped sandpaper around a $\frac{3}{8}$ " dowel.)

ADDING THE LID

Note: To form a tighter seal between the canister top and lid, we applied felt tape to the lid. Applying felt to the bottom edge of the lid raises it $\frac{1}{16}$ " above the hinge support (E). To compensate, plane the lid pieces (H, I, J) to $\frac{1}{16}$ ".

1 To form the lid sides (H) and back (I) cut a piece of $\frac{3}{4}$ " oak to 1×22 " long. Cut another piece to $1\frac{1}{2} \times 7\frac{1}{2}$ " for the contoured front (J). Now, plane, joint, or resaw both pieces to $\frac{1}{16}$ ".

2 Using carbon paper, transfer the full-sized Lid-Front Pattern below to a piece of paper. Use spray adhesive to stick the pattern to the lid front, and cut the contoured edge to shape (do not cut the ends yet). Sand the front edge smooth.

3 Cut or rout a $\frac{3}{8}$ " rabbet $\frac{1}{2}$ " deep along the inside edges of the lid pieces.

4 Miter-cut the parts (H, I, J) to the finished length listed in the Bill of Materials. Remove the paper pattern from the lid front. (We used this front as a template to mark the other fronts.)

5 Spread glue on the mating surfaces of the lid pieces, and band-clamp them together, checking for square.

6 Resaw the stops (K, L) to $\frac{1}{4}$ " thick. Now, rip these to $\frac{3}{8}$ " wide and miter-cut the parts to finished length. (For safety and ease in handling, we cut long strips to thickness and width on the band saw, and then miter-cut the long pieces to length.)

FINISHING AND FINAL ASSEMBLY

1 Finish-sand the canister and lid, sanding a very slight round-over on all sharp edges.

2 Have glass cut to size for each canister lid (see the Buying Guide for the size and our source).

3 Snip the head off a $\frac{3}{4}$ " brad, chuck it in your hand drill, and use it as a bit to drill pilot holes in the stops (K, L).

4 Position the glass in the rabbet. Nail the stops in position with $\frac{1}{2}$ " brads and a light hammer (9 or 10 ounces) as shown in the photo below left. Set the brads. (Note in the photo, that we taped a piece of thin cardboard to the glass. This protects the glass when nailing and setting the brads.)

5 Apply the finish of your choice. (We stained our canisters first, and then applied polyurethane on the exterior and a salad-bowl finish on the inside.)

6 Apply self-adhesive felt tape to the underside of the lid sides and front. Also, adhere a strip of the felt tape along the back edge of the lid where shown in the drawing below. See the Buying Guide for our source of felt tape.

7 Finally, slide the lid assembly firmly against the hinge support (E), drill pilot holes, and screw the hinges in position.

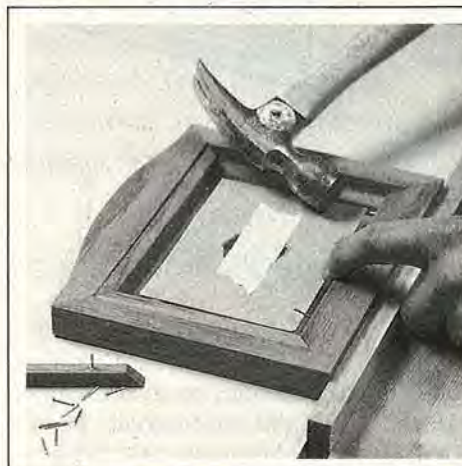

BOTTOM SIDE OF COVER

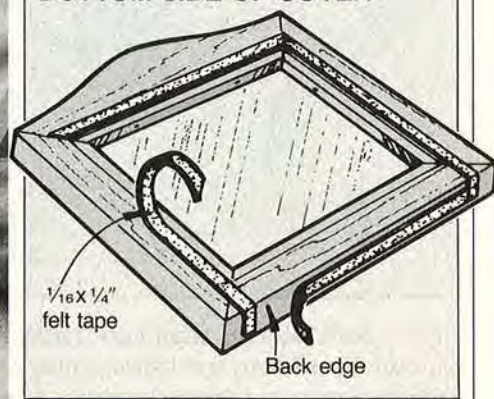

LID FRONT (Full Size)



Brass Scoop



Top off your canister set with our oak and brass scoop. Not only does it complement the canisters, it's super-handy for removing those vital cooking ingredients.

MAKING THE SCOOP

1 Plane or resaw a scrap of oak to $\frac{1}{2}$ " thick. Mark a $2\frac{1}{2}$ "-diameter circle on the $\frac{1}{2}$ " scrap. Cut the disk to shape for the scoop back (M). Drill a $\frac{1}{2}$ " hole through the center point and sand the disk smooth.

2 Cut a piece of $\frac{1}{2}$ " dowel stock to 4" long for the scoop handle (N). Sand a round-over on one end. (We sanded the round-over to shape on a belt sander.)

3 Glue the dowel handle in the hole in the scoop back. Later, scrape off any excess glue, finish-sand, and apply the finish.

4 Using carbon paper, transfer the full-sized scoop pattern and hole locations to paper, and cut the paper to shape with a scissors. Apply spray adhesive to the paper pattern, and stick it to a piece of 4×5 " .010"-thick brass (most hobby stores sell thin brass sheets).

5 Cut the brass to shape with a scissors, and sand or file the cut edge smooth.

6 With the pattern still on the brass, drill the four $\frac{9}{64}$ " holes. Remove the paper pattern.

7 Roll the brass around a 16-ounce pop bottle to preform it. Now, position the rounded brass on the scoop back, and drill a $\frac{3}{32}$ " pilot hole $\frac{1}{2}$ " deep into the scoop back. Fasten the brass to the scoop back with a #6x $\frac{1}{2}$ " brass wood screw. Keeping the brass tight against the scoop back, start at one side and work your way around the disk drilling holes and fastening the brass.

Labels in diagram:
 $\frac{1}{2} \times 2\frac{1}{2}$ "-diameter oak disk
 $\frac{1}{2}$ " oak dowel 4" long
 Round-over end
 $\frac{3}{32}$ " pilot hole $\frac{1}{2}$ " deep
 #6x $\frac{1}{2}$ " R.H. brass wood screw (4 needed)
 $\frac{1}{2}$ " hole
 .010" brass
 $\frac{9}{64}$ " hole

Part	Finished Size			Material	Qty.
	T	W	L		
M	$\frac{1}{2}$ "	$2\frac{1}{2}$ " diam.		oak	1
N	$\frac{1}{2}$ " diam.		4"	oak dowel	1

Supplies: Paper for pattern, carbon paper, spray adhesive, $\frac{1}{4}$ " dowel stock, .010" brass (available at hobby shops), #6x $\frac{1}{2}$ " brass wood screws, finish

BRASS SCOOP (Full Size)

BUYING GUIDE

● **Glass.** Hand-blown full antique glass, $\frac{1}{8} \times 4\frac{1}{16} \times 6\frac{3}{16}$ ", \$5.50 each, or a set of four for \$13 (both prices include shipping and handling). The Stained Glass Store, 3617 Ingersoll Ave., Des Moines, IA 50312, or call 515/279-4855.

● **Hinges.** Catalog no. D3018, 90 cents per pair. The Woodworkers' Store, 21801 Industrial Blvd., Rogers, MN 55374, or call 612/428-2199 to order.

● **Felt tape.** $\frac{1}{4}$ " width, catalog no. D1715, 35 cents per foot (28" needed per canister). The Woodworkers' Store, address above. 🍄

Project Design: Dave Ashe
 Photographs: Hopkins Associates;
 Jim Kascoutas

Illustrations: Kim Downing; Bill Zaun

Spice Cabinet

CRAFT A COUNTRY CLASSIC



It all came down to convenience. Spices were used in almost every dish and needed to be close at hand. Time spent rummaging through the cupboard for a pinch of basil or teaspoon of cinnamon was time wasted. The ingredients needed to be easily accessible and orderly displayed for the quick finding of just the right one. The spice cabinet became the perfect solution.



Most spice racks do an adequate job of keeping herbs and other flavorings at the ready. But this project doesn't stop there. It offers a bank of drawers and several shelves for storing your spices and displaying your favorite kitchenware. The antique glass doors and porcelain drawer knobs also add a fitting design accent to the quaint lines of the spice cabinet.

FIRST, CONSTRUCT THE CASE

1 Cut the case sides (A), inner shelves (B), and lower shelf (C) to the sizes listed in the Bill of Materials plus $\frac{1}{16}$ " in width.

2 Using the dimensions on the Exploded-View Drawing, locate the four dadoes on the side pieces and cut $\frac{3}{8}$ " dadoes $\frac{3}{8}$ " deep. Now, cut a $\frac{3}{8}$ " rabbet $\frac{3}{8}$ " deep along the ends of each shelf. (We test-cut a rabbet in a piece of scrap and checked its fit in the dadoed sides first.)

3 Cut or rout a $\frac{1}{4}$ " rabbet $\frac{3}{8}$ " deep along the back inside edge of each side piece. (We cut our rabbets with a table saw. If you go this route, mount an auxiliary-wood fence to

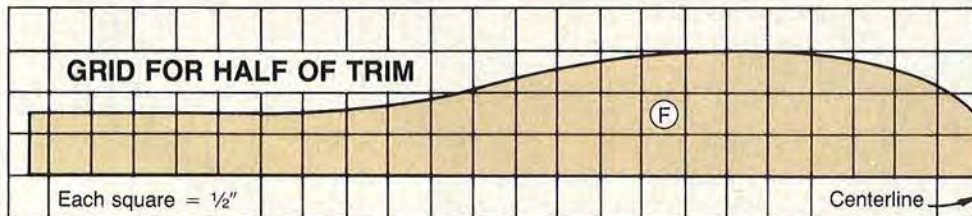
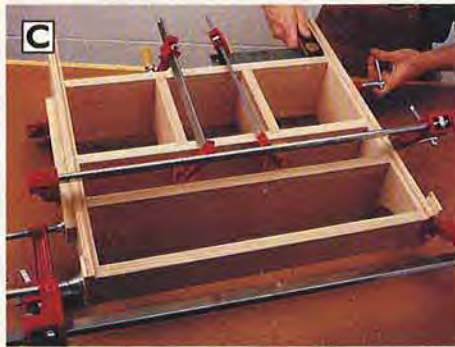

your rip fence and a dado blade set to cut $\frac{3}{8}$ " wide to the saw arbor.) Measure and position the outside edge of the dado blade $\frac{1}{4}$ " from the outside edge of the wooden fence. Start the saw and raise the blade $\frac{3}{8}$ " above the surface of the saw table and into the wood fence. Cut the rabbet as shown in photo A.

4 Joint, plane, or saw $\frac{1}{16}$ " off the front edge of sides and shelves to remove any chipping that may have occurred when you cut the dados and rabbets.

5 Using double-faced tape, stick the sides together face to face, making sure to align the dados and rabbet. Set your compass at 3"

and lay out the radius on the lower front corner of the sides where shown in the Exploded-View Drawing. Cut the radius to shape, sand smooth, separate the pieces, and remove the tape.

6 Lay out and cut $\frac{3}{4}$ "-wide stopped dados $\frac{1}{4}$ " deep into the bottom side of the top shelf and the top side of the center shelf where shown in the Exploded-View Drawing. Cut or rout the stopped dados to size. (After marking the location of the dados, we clamped the two shelves together with the front edge of one butting the front edge of the other. Then, we clamped a straight

board to act as a fence and used a $\frac{3}{4}$ " straight bit to rout the stopped dados as shown in photo B.) Finally, chisel the rounded ends of the dados square.

7 Cut the dividers (D) to size. Then, dry-clamp the case together to check the fit of all joints. Remove the clamps and sand all the pieces smooth. Next, glue and clamp the parts together checking for square as shown in photo C. Also, remember to keep the shelves flush with the inside edge of the rabbet on the back edge of the sides. Remove any excess glue.

NOW, ADD THE TOP, TRIM, CLEAT, AND BACK

1 Cut the top of the case (E) to size. Then, rip and crosscut a piece of $\frac{3}{4}$ " oak to $1\frac{1}{2} \times 22\frac{1}{2}$ " for the top trim (F). On a piece of paper draw a $\frac{1}{2}$ " grid. Using the Trim Grid at left as a guide, mark the points where the trim outline crosses each grid line. Connect the points to complete the pattern. Apply spray adhesive to the back of the pattern and stick it on the trim piece. Cut the trim piece to shape and remove the pattern.

2 Cut the cleat (G) to size. Then, rout a $\frac{1}{4}$ " round-over along the top (E) and cleat where shown in the Exploded-View Drawing.

Drill two mounting holes in the cleat. (The size and spacing of these depends on how you hang the spice shelf. Use flathead wood screws if you can locate wall studs; toggle bolts if you can't.)

3 Finish-sand the top of the case, the trim piece, and the cleat. Dry-clamp the top to the case with the back edges flush and a $\frac{3}{4}$ " overhang at both ends. Measure in $1\frac{1}{8}$ " from the ends of the top (where shown on the Exploded-View Drawing), and drill plug, shank, and pilot holes to the sizes listed on the drawing. Glue and screw the top to the case. Add oak plugs and sand the surface smooth.

Spice Cabinet

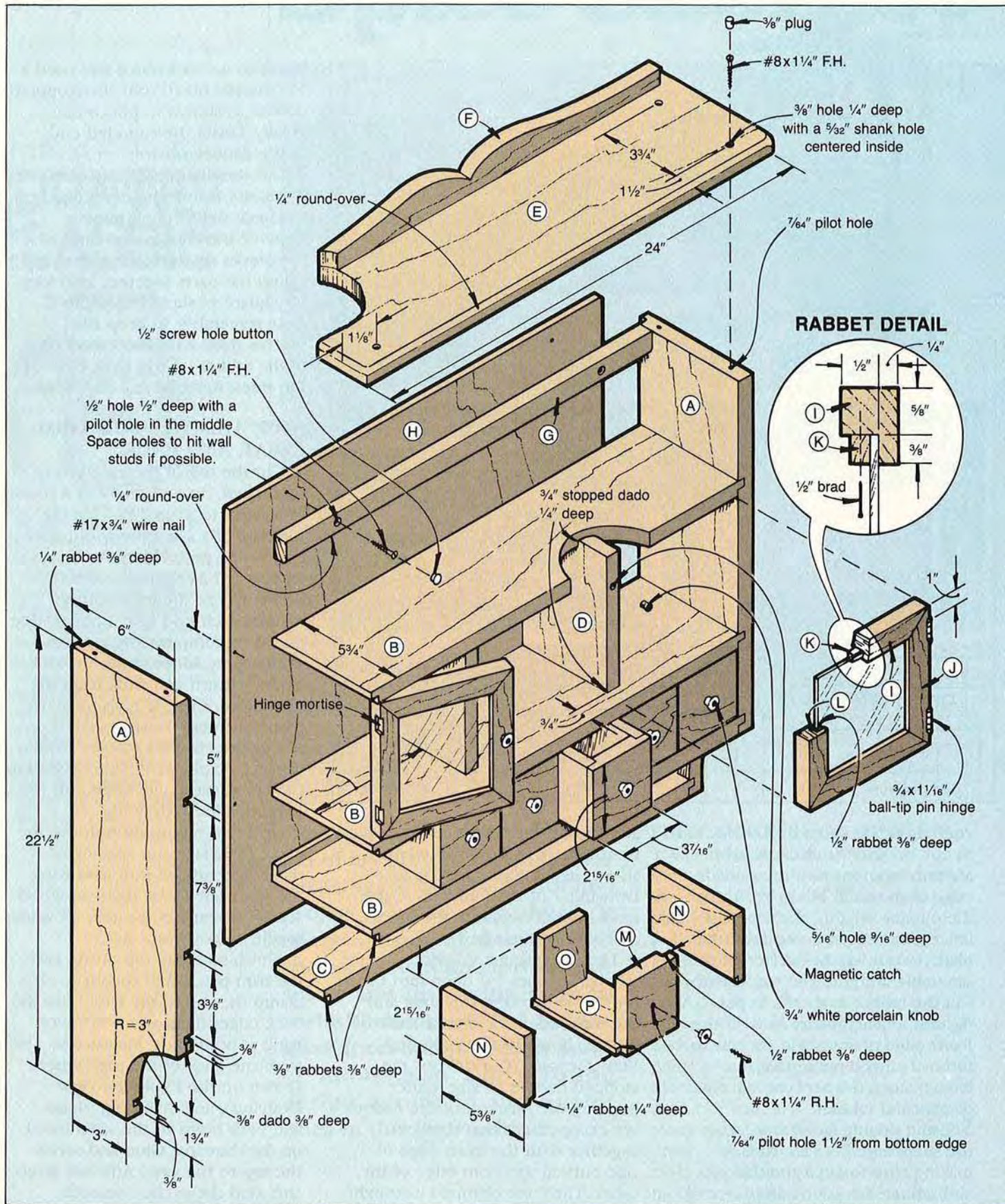

Bill of Materials

Part	Finished Size*			Material	Qty.	Part	Finished Size*			Material	Qty.
	T	W	L				T	W	L		
THE CASE						THE SIX DRAWERS					
A*	3/4"	6"	22 1/2"	oak	2	M*	3/4"	2 15/16"	3 7/16"	oak	6
B*	3/4"	5 3/4"	21 3/4"	oak	3	N*	1/2"	2 5/16"	5 3/8"	oak	12
C*	3/4"	2 3/4"	21 3/4"	oak	1	O	1/2"	2 7/16"	2 1 1/16"	oak	6
D	3/4"	5"	7 1/2"	oak	2	P	1/4"	2 5/16"	5 1/4"	oak plywood	6
E	3/4"	6 3/4"	24"	oak	1	*Parts marked with an * are cut larger initially; then trimmed to finished size. Please read the instructions before cutting.					
F	3/4"	1 1/2"	22 1/2"	oak	1						
G	3/4"	1"	21"	oak	1						
H	1/4"	21 3/4"	22 1/2"	oak plywood	1						
THE TWO DOORS											
I*	3/4"	1"	7 3/8"	oak	4	Supplies: double-faced tape, #8x1/4" F.H. wood screws, #17x3/4" wire nails, 1/2" brads, 1/2" screw hole buttons, spray adhesive, stain, polyurethane, salad bowl finish					
J*	3/4"	1"	6 7/8"	oak	4						
K*	1/4"	3/8"	6 1/8"	oak	4						
L*	1/4"	3/8"	5 5/8"	oak	4						

Cutting Diagram

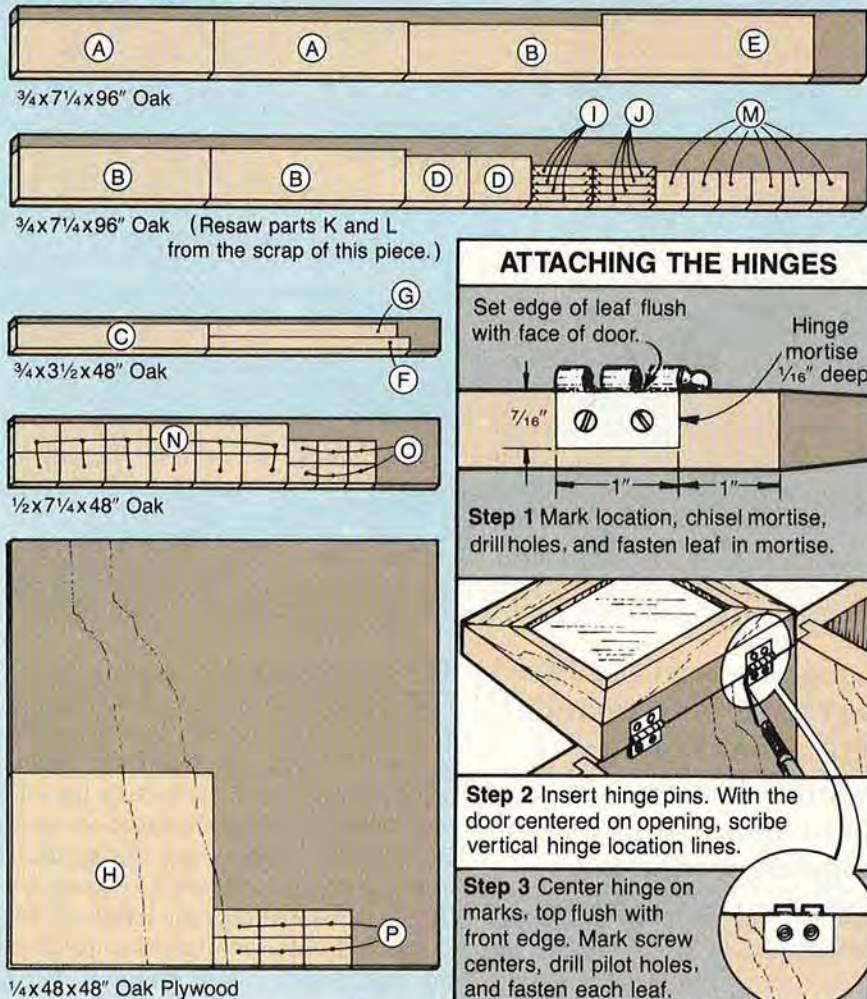

ATTACHING THE HINGES

Set edge of leaf flush with face of door.

Hinge mortise 1/16" deep



Step 1 Mark location, chisel mortise, drill holes, and fasten leaf in mortise.

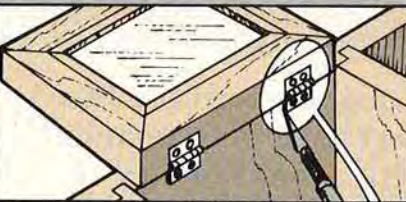

Step 2 Insert hinge pins. With the door centered on opening, scribe vertical hinge location lines.

Step 3 Center hinge on marks, top flush with front edge. Mark screw centers, drill pilot holes, and fasten each leaf.

- 4 Glue and clamp the cleat (G) to the bottom side of the top (E) where shown on the Exploded-View Drawing.
- 5 Glue and clamp the trim piece (F) to the top, flush with the back edge of the top and centered from side to side.
- 6 Cut the back (H) to size from 1/4" oak plywood. Check its fit in the rabbeted opening in the back of the case and set it aside for now.

NEXT, BUILD THE DOORS

- 1 For the door frames, cut four strips of 3/4" oak 1x16" long. Now, rout or cut a 1/2" rabbet 3/8" deep along one edge of each piece where shown on the Rabbet Detail accompanying the Exploded-View Drawing. Then, miter-cut the door tops and bottoms (I) and sides (J) to finished length.
- 2 Glue and clamp each door frame together with band clamps, checking for square. Later, scrape off the excess glue.
- 3 To make the stops (K, L) from 3/4" oak stock, resaw long strips to 1/4" thickness, cut to 3/8" wide, and then miter-cut the stops to length.
- 4 Snip the head off a 1" brad. Chuck the brad in your drill, and use it as a bit to drill two pilot holes through each stop (K, L).
- 5 Using the three-step drawing at left as a guide, attach the hinges to the doors and then to the cabinet sides. Hang the doors.
- 6 Drill a 3/16" hole 1/16" deep in each divider (D) to accept the magnetic catches. Insert one in each hole. Close the doors almost completely, and mark where the magnetic catch makes contact with the back of each door. Remove the doors, and then drill a pilot hole and drive a mating screw for each magnetic catch.
- 7 To mount the porcelain knobs, measure up 3 3/8" from the bottom of each door and drill a 7/64" pilot hole 1/2" deep for each knob. (Instead of using the machine screw that comes with the knobs, we substituted a #8x1 1/4" round-head wood screw in its place.)

Continued on page 85

Paper Towel

CRAFT A COUNTRY CLASSIC

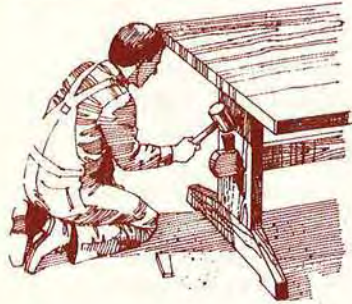

Before the introduction of the fancy hardware and fasteners we enjoy today, the early furniture makers had to rely on devices fashioned from wood.

When building trestle tables, the Shakers developed the wedge key to secure the cross member to the base ends. Tapped into place, the wedge key secured the joint. Tapped back out, it allowed the table base to be quickly disassembled for ease in moving.

 Print this article



Finally, a paper-towel holder you don't have to hide under the kitchen sink! In fact, you'll want to mount it in a prominent spot to show off the intriguing wedge-key joint that secures the towel roller in place.

START WITH THE END PIECES

1 Rip and crosscut two pieces of $\frac{3}{4}$ " oak to $7\frac{1}{4}$ " wide by $8\frac{1}{2}$ " long. Then, using double-faced tape, stick the two oak pieces together face to face with the edges flush. Using the drawing of the end piece (A) on the next page as a guide, lay out the shape and hole location on one of the end pieces.

Holder

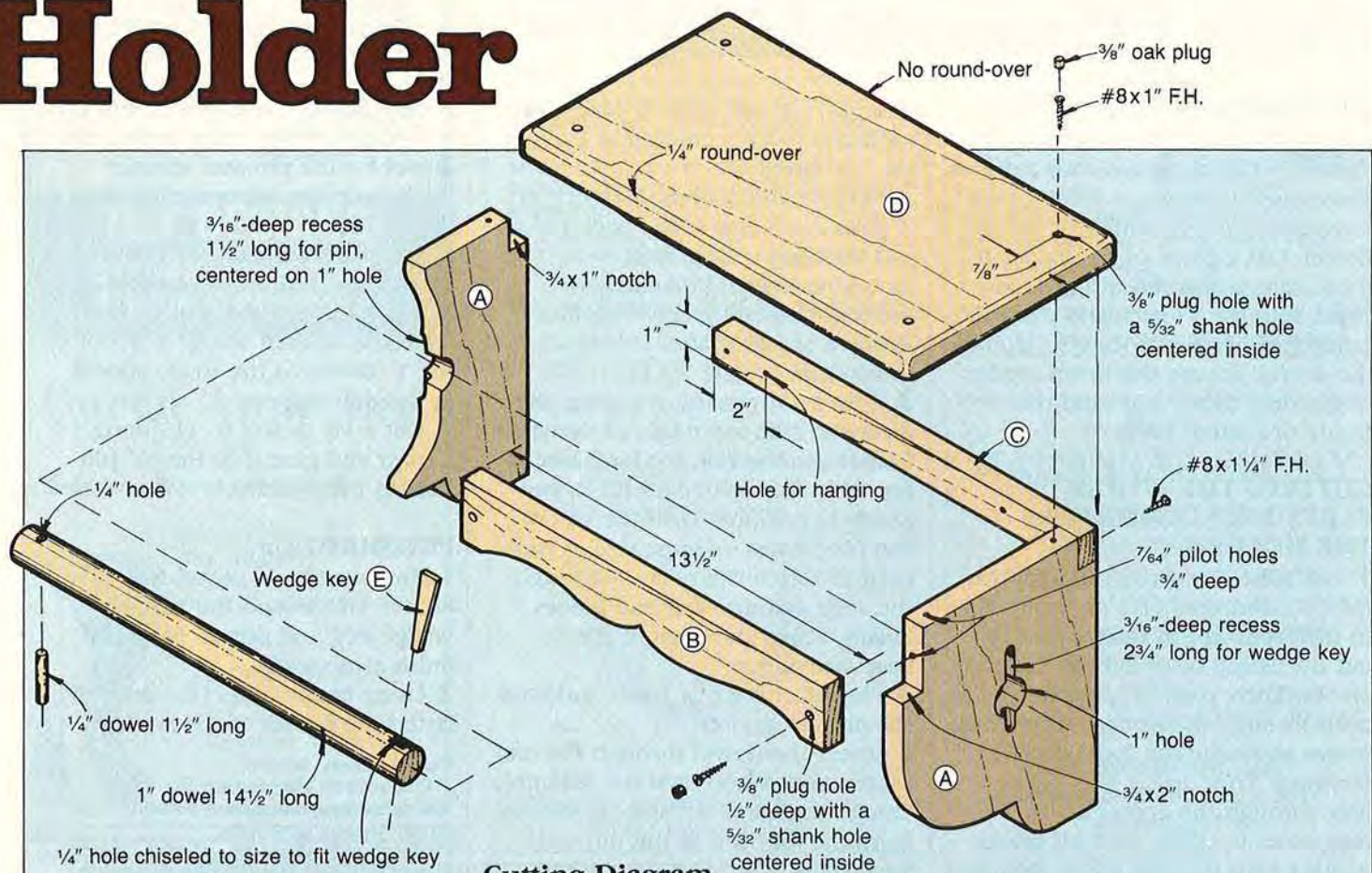

Cutting Diagram

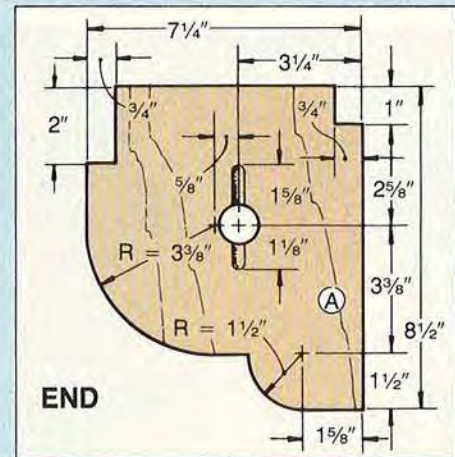
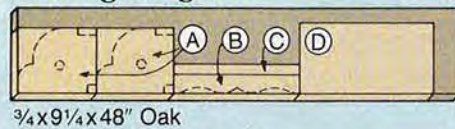

Bill of Materials					
Part	Finished Size			Material	Qty.
	T	W	L		
A	3/4"	7 1/4"	8 1/2"	oak	2
B	3/4"	2"	13 1/2"	oak	1
C	3/4"	1"	13 1/2"	oak	1
D	3/4"	7 3/4"	14 1/2"	oak	1
E	1/4"	1/2"	2"	oak	1

Supplies: 1" oak dowel, 1/4" oak dowel, double-faced tape, paraffin, #8x1" flat-head wood screws, #8x1 1/4" flat-head wood screws, stain, finish, toggle bolts

2 Cut the two notches in the taped-together end pieces using a table saw and miter gauge.

3 Drill a 1" hole through the pieces, backing the bottom piece with scrap to prevent chip-out. Using the End Drawing as a guide, lay out the recess for the wedge key on one end piece and the pin on the other. Stick the end pieces to your workbench top with double-faced tape.

4 To form the wedge-key and dowel-pin slots, start by fitting your router with a 3/8"-core box bit set to cut to a depth of 3/16". Attach an edge guide to your router base, and position the inside edge of the guide exactly 3/4" from the center of the bit. As shown in the photo above, rout a 2 3/4"-long slot for the wedge key on one of the end pieces. Flip the end pieces over, retape to the

workbench, and rout a 1 1/2"-long recess centered over the 1" hole for the 1/4" dowel pin.

5 Cut the end pieces to shape with a band saw or jigsaw; then sand the contoured edges smooth. Separate the two pieces and remove the double-faced tape.

6 Cut a 1"-diameter dowel to 14 1/2" long. For a smooth fit of the dowel through the 1" hole in each end

Continued

Paper Towel Holder

piece, sand the inside of each hole larger. (We made the drum sander shown in the photo *below*.) You can make one by cutting a 4"-long kerf in one end of a 7" length of $\frac{3}{8}$ " dowel. Cut a piece of sandpaper to 4x4", insert one end of the sandpaper into the 4" kerf, and wrap the sandpaper counterclockwise around the dowel. Secure the drum sander in the drill chuck and sand the inside of each 1" hole.

CUTTING THE OTHER PARTS AND ASSEMBLING THE HOLDER

1 Cut the front apron rail (B), rear rail (C), and shelf (D) to size (refer to the Front-Apron Drawing to lay out B). Clamp both rails to the end pieces. Then, drill $\frac{3}{8}$ " plug holes $\frac{1}{2}$ " deep through the front and rear rails where shown in the Exploded-View Drawing. Now, drill a $\frac{5}{32}$ " shank hole through the center of the $\frac{3}{8}$ " plug holes until the drill bit makes contact with the end piece. Switch

to a $\frac{7}{64}$ " bit, and drill $\frac{3}{4}$ " deep into each end piece, centered in each of the $\frac{5}{32}$ " holes.

2 Remove the clamps. Measure in 2" from each end of the back rail, and drill and countersink two mounting holes. Glue and screw the rails and end pieces together. Remove any glue after it forms a tough skin.

3 Rout a $\frac{1}{4}$ " round-over along the front and side top edges of the shelf. Center the shelf on the base assembly with the back edges flush, and clamp in position. Drill the screw and plug holes — same size as those used to attach the rails — through the shelf and into the end pieces. Finally, screw the shelf to the base assembly.

4 Plug all the screw holes and sand the project smooth.

5 Insert the dowel through the end pieces, and center it in the assembly. Using the earlier cut slots as guides, mark the location of the pin and wedge-key hole locations on the

dowel. Remove the dowel, and drill a $\frac{1}{4}$ " hole through one end of the dowel for the pin and another $\frac{1}{4}$ " hole in the other end for the wedge key.

6 Cut the wedge key (E) to size using the full-sized drawing *below* as a guide. With a sharp $\frac{1}{4}$ " chisel, form the tapered wedge-key slot in the 1" dowel to the shape shown in the drawing.

7 Cut a $\frac{1}{4}$ " dowel to $1\frac{1}{2}$ " long. Center and glue it in the $\frac{1}{4}$ " pin hole in the 1" dowel.

FINISHING UP

1 Remove the 1" dowel from the holder. Finish-sand the holder, wedge key, and dowel. Stain and finish as desired.

2 Using toggle bolts (for drywall), fasten the holder to the wall. 📌

Country-Classic Section
Produced by Marlen Kemmet
Graphic Design by Perry McFarlin
Project Design: Dave Ashe
Photographs: Jim Kascoutas; Hopkins Associates
Illustrations: Kim Downing; Jim Stevenson

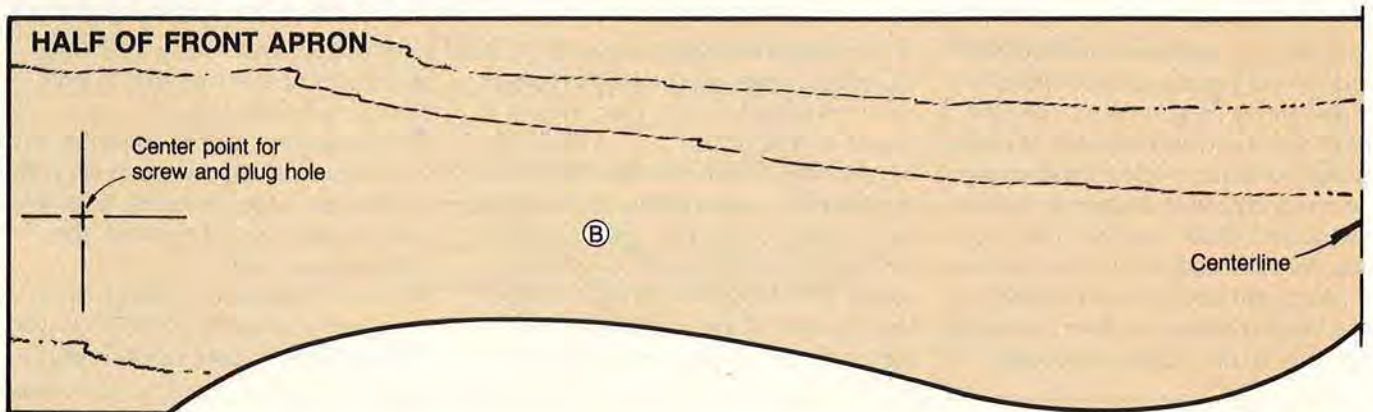
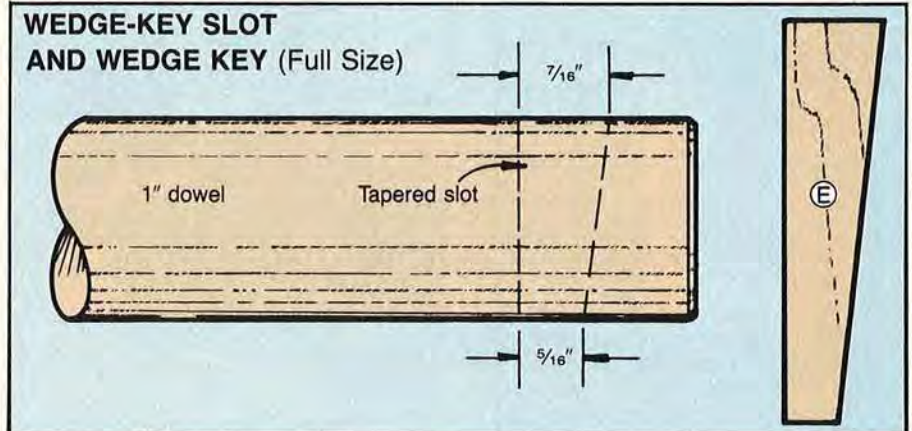

BUILD A CLASSIC

2 Full Size Patterns for Chrysler Sedan & Graham Bros. Truck\$10.00.

10 Spoke Wheels.....\$7.50

Catalog\$1.50



TOY DESIGNS

DEPT. BW187 • BOX 441
NEWTON, IOWA 50208

Queen Anne Leg

by

Adams Wood Products, Inc.

Prompt delivery
Any quantity
Different styles & sizes
Various woods

FREE BROCHURE

974 Forest Dr., Dept. M-2
Morristown, TN 37814

615/587-2942



National Carvers Museum

LEARN
WOODCARVING
AT HOME

Receive sample instructional pack on whittling and woodcarving. Includes copy of *Mallet* monthly magazine.

Send \$1.00 to The National Carvers Museum, 14960 Woodcarver Rd., Monument, CO 80132.
(303) 481-4737

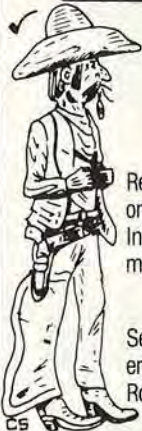

Make Signs?

If you make or are interested in wood signs, you'll want SignCraft — the magazine for the sign artist. You'll see creative wood signs in every issue — carved, routed and sandblasted — plus how to's, pricing, technical help and more! Your satisfaction is guaranteed.

- 1 yr. (6 issues) . . . \$21
- 1 yr. Outside U.S. (U.S. funds) \$27

SignCraft Magazine
P.O. Box 06031-W, Ft. Myers, FL 33906

HORTON BRASSES

Nooks Hill Road, P.O. Box 120J
Cromwell, CT 06416 (203) 635-4400

HORTON BRASSES are authentic copies of 17th, 18th, 19th & early 20th century pulls



Mfrs. of Cabinet & Furniture
Hardware for Homes & Antiques.
Send \$2.00 for a Catalogue.

MAKE WHIRLIGIGS WOOD TOYS

100's of plans, parts, kits, books, finishes & supplies for toys, whirligigs, classic autos, swing sets, doll houses, crafts & furniture. Also toy, craft, game & furniture parts in maple, oak, walnut & cherry. Bulk prices available. Color catalog subscription \$1. (614) 484-4363
Cherry Tree Toys, Box 369-409, Belmont, OH 43718



1 7/4" long

DUCK KITS

\$19.00 Precut Kit

just assemble & paint

\$15.00 Uncut Kit

just cut, assemble & paint

—Rare—

MACASSAR EBONY

MAGNIFICENT GRAIN,
high figure or subtle.

MATCHLESS DIMENSIONS,
1" up to 9" thick, 4" up to 20" wide.
Random lengths to 9 feet. Best selection available in the U.S.

LOWEST COST from a DIRECT IMPORTER. NO MINIMUM ORDER.

A. Eisenbrand, Inc.

4100 Spencer Street, Suite EW6
Torrance, CA 90503

(213) 542-3576

MITER/BEVEL GAUGE SET

FOR A PRECISE SETTING OF BLADE,
MITER OR BEVEL ON RADIAL ARM SAWS.
ELIMINATE TRIAL AND ERROR.



Six Angles, 15°—18°—22.5°—30°—45°—60°, included in set. Each angle attaches to bar. You will find many uses in the shop or home. Patent Pending. Rush order today—

Miter/Bevel Gauge set **ONLY \$29.95**

Please send payment with order. Shipping/handling included.

ROBERT S. SMITH INC. Dept. WF 87
P.O. Box 17330, Phoenix, Arizona 85014

Watch for other new products from: Robert S. Smith Inc.
an Innovation Company, Dealer Inquiries Invited.



Love At First Sight

Scale woodworkers will fall in love with this 1" scale miniature of an 1849 CONCORD STAGE COACH. FULL SIZE CUTTING PATTERNS, 1 NOT A KIT!, PHOTOS, ASSEMBLY VIEWS and CONSTRUCTION HINTS FOR EASY BUILDING.....\$14.95. • Conestoga Covered Wagon/ 1893 Duryea Motor Car - the first gas auto. 1" scale. \$14.95 each. "Making Model Horse Drawn Vehicles" by John Thompson- ppbk, 94 pages w/plans and techniques for miniatures. \$15.95. With this ad- 2 patterns \$25 • 3 patterns \$36.95 • All 4 items \$49.95. Please add \$2 hdg/insur. NJ res. add 6% tax. Visa/Mastercard \$20 minimum. Tel. orders: (201) 835-9339.

CRISS-CROSS Box 324BC WAYNE, N.J. 07470

A NEW TOOL!

accujoint™
Patent Pending

MONEY BACK GUARANTEE



Make precision finger joints on your table saw!

Just set your blade, accujoint will index your work exactly! PERFECT EVERY TIME

Only \$39.95

PLUS \$2 (in U.S.)
Shipping & Handling
Mass. residents add 5% tax

Morse Design, Inc.
P.O. Box 195
Boston, MA 02123

TO ORDER — INFO
CALL 1-800-222-8011
Mass. (617) 262-8436

VISA/MC

NEW AND UNUSUAL TOOL CATALOG

Over 100 pages of latest books and quality woodworking hand tools at **NEW LOW PRICES.** Send for **FREE FROG CATALOG** today.

FROG TOOL CO. Ltd.
P.O. Box 8325 Dept. WM8
CHICAGO, IL 60680
Store: 700 W. Jackson
(312) 648-1270

POWER TOOLS

SAVE \$50 TO \$500



METAL PARTS KITS AT LOW FACTORY DISCOUNT PRICES FOR

- 12-IN. BAND SAW
- 18-IN. BAND SAW
- WOOD SHAPER
- 6-IN. BELT SANDER
- 10-IN. TILT/ARBOR SAW
- LATHE/DRILL PRESS COMB.

\$500
per Plan

KITS FROM \$34.99 TO \$189.99

Easy to follow step-by-step plans. Photos. No machining, no welding. Build your own sturdy frame. Full scale patterns. 98,000 kits sold. Send \$6 for plans, brochure and prices or \$1 for brochure and prices. Order kits on Visa or MasterCard.

GILLIOM MFG., INC. MONEY BACK GUARANTEE
1700 Scherer Pkwy, Dept. BHW701
St. Charles, Mo. 63303 Phone (314) 724-1812



ASHMAN TECHNICAL LTD.

Machinery • Tools
• Shop Equipment •

351 Nash Rd, N.,
Hamilton, Ont., Can. L8H 7P4
(416) 560-2400

CALL TOLL FREE **1-800-263-4507**

DUTY CHARGES INCLUDED IN ALL PRICES
DELTA or GENERAL
(UNISAW)



3 H.P. — 10" TILTING ARBOR SAW
\$1140.00
UNIFENCE OR BIESEMEYER MODELS
\$1340.00
3 H.P. Single Phase — 230 V
60 cycle with Magnetic Starter

- 13" Delta planer RC33 2HP with stand \$ 999.
- 20" Delta planer RC51 5HP \$3490.
- 8" Jointer with Stand — General \$1030.
- 6" Jointer with Stand — General - 1 H.P. \$ 585.
- 15" Woodcutting Bandsaw with Stand \$ 595.
- 12" Wood Lathe with Stand — General \$ 688.

Two-Year Warranty on all Delta Products.

U.S. FUNDS — FREIGHT COLLECT

— CALL FOR QUOTATION —

Cascade Precision Tool Co.

Box 848, Mercer Island, WA 98040

OFFERING PREMIUM QUALITY **S** BRAND CARBIDE TIPPED ROUTER BITS AND SHAPER CUTTERS



FREE 1/2" DOVETAIL WHEN YOU ORDER THIS SET OF CARBIDE-TIPPED ROUTER BITS INCLUDING 1/4" RABBIT, 1/2" OGEE, 1/2" COVE, 1/2" ROUND-OVER, 1/2" AND 1/4" STRAIGHT BITS WITH EXTRA BEARING FOR BEADING

1/4" SHANK SET \$64.95 PPD. 1/2" SHANK SET \$69.95 PPD.



CARBIDE TIPPED 3-PIECE ROUTER BIT SET WITH 1/2" SHANK AND 3/8" O.D. PANEL RAISER. AVAILABLE IN 5 PROFILES BELOW. RAILSTILE CUTTERS AVAILABLE IN ROUND-OVER, COVE AND TRADITIONAL PROFILES \$179.95 per set

ROUTER BIT PANEL RAISER ALONE \$59.95



3 WING PANEL RAISERS IN 5 PROFILES 3 mm (1/8") CARBIDE \$69.95 ea.

4 3/4" O.D. WITH 3/4" BORE & 1/2" BUSHING OR 5 1/2" O.D. WITH 1 1/4" BORE & 1" BUSHING



5° FACE CUT 15° FACE CUT CONCAVE 12° FACE & QTR RD CONVEX

SHAPER CUTTERS

3/4" BORE WITH 1/2" BUSHING

from \$29.95

1/2" BORE IN 20 PROFILES - \$22.00

6-PIECE CABINET SETS

3/4" BORE WITH 1/2" BUSHING

BUSHING \$179.95

"MAGNUM LINE"

SHAPER CUTTERS — CABINET/DOOR SETS

4 Wing • 1 1/2" Bore (1" Bushing) • 4"-4 1/2" Diameter • 3 mm (1/8") thick carbide

AVAILABLE AT AFFORDABLE PRICES

ORDER BY PHONE WITH VISA/MC OR SEND MO. CHECK, VISA/MC NUMBER, EXP. DATE, PHONE NUMBER. CATALOG \$1 — FEATURING OVER 200 CARBIDE TIPPED ROUTER BITS AND SHAPER CUTTERS.

DEALER INQUIRIES INVITED

SATISFACTION GUARANTEED

ORDER TOLL FREE

1-(800) 235-0272

IN WASHINGTON CALL 1-206-236-0272

CHARGE YOUR ORDER

10 AM-7 PM

Monday through Saturday



WOODWORKERS

-PORTER+CABLE-
PROFESSIONAL POWER TOOLS

Speed-Bloc® Finishing Sander



Model No. 330

SALE!
\$55.00 ppd

FREE CATALOG SUBSCRIPTION WITH PURCHASE.

CATALOG ONLY.

2 year subscription (8 issues) \$4.00.
Free \$5.00 gift certificate with catalog order.

R. A. NESS & CO.

THE WOODWORKERS EMPORIUM

8888 N. MILWAUKEE AVE.

NILES, IL 60648

(312) 824-0565



WOODWORKERS' SOURCE

The New 1987 Catalog

114 pages of Veneers, Wood Parts, Specialty Hardware, Tools, Pulls, Finishing Supplies, Books, Kits, Plans and more new products.

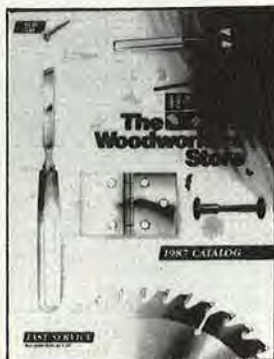

Please Enclose \$1.00 (3rd class)
 \$2.00 (1st class)

Name _____

Address _____

City _____ State _____ Zip _____



21801 Industrial Blvd., Dept. 910
Rogers, MN 55374

HENZEY BOWBACK WINDSOR

The original is at Independence Hall.

The kit is in our catalog.



Kit \$198,
assembled finished \$329.

Please send your color catalog of authentic museum reproduction furniture kits, fabric, pewter, paint and stain. I'm enclosing \$2.

Name _____

Address _____

City _____ State _____ Zip _____



497AB Ship St., Cohasset Harbor, MA 02025, Tel (617) 783-0110

Ad Council

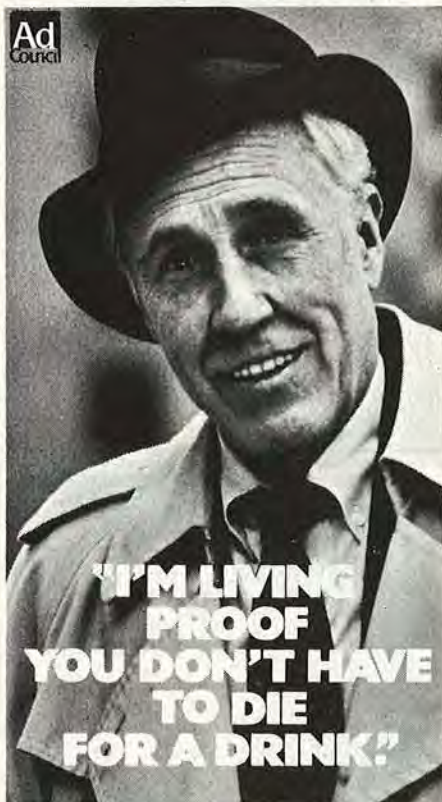

"I'M LIVING PROOF YOU DON'T HAVE TO DIE FOR A DRINK!"

Get Help Like Jason Robards Got.
Call The National Council on Alcoholism In Your Area.
Or write NCA, 733 Third Avenue,
N.Y., N.Y. 10017

Spice Cabinet

Continued from page 79

CUT AND ASSEMBLE THE DRAWERS

- 1 Cut one piece of $\frac{3}{4}$ " oak to $2\frac{1}{16} \times 22$ " for the drawer fronts (M), and two pieces of $\frac{1}{2}$ " oak to $2\frac{1}{16} \times 35$ " for the sides (N). (We planed $\frac{3}{4}$ " stock down to $\frac{1}{2}$ " thickness for the sides and backs).
- 2 Now, rout or cut a $\frac{1}{4}$ " rabbet $\frac{1}{4}$ " deep along the bottom inside edge of each of the three pieces.
- 3 Set a stop on your saw and cut the fronts $3\frac{7}{16}$ " long. Reposition the stop and cut the sides to length. Cut a $\frac{1}{2}$ " rabbet $\frac{3}{8}$ " deep along both ends of each drawer front.
- 4 Cut the backs (O) and bottoms (P) to finished size.
- 5 Glue and clamp the drawers together checking for square. Later, remove the clamps and check the fit of all drawers in the opening. Sand if necessary.
- 6 To locate the drawer pulls, position all the drawers in the opening, and then draw a line across the

fronts $1\frac{1}{2}$ " up from the bottom edge of the drawer fronts. Remove the drawers, and drill a $\frac{7}{64}$ " pilot hole for the pulls through each front through the line and centered from side to side.

ADD THE FINISHING TOUCHES

- 1 Remove all the hardware (except the magnetic catches — just cover them with masking tape). Then, apply stain to all the pieces, being sure to wipe on with the grain. Later, apply several coats of finish. (We applied two coats of polyurethane varnish to the case, doors, and drawer exteriors; two coats of salad bowl finish to the drawers' interiors.)
- 2 Glue and nail the back (H) in position. Reattach the hinges and knobs. Use the technique and photo reference on page 74 of the canister article to install the glass. Hang both doors.

BUYING GUIDE

- **Porcelain knobs.** $\frac{3}{4}$ " diameter, $\frac{5}{8}$ " projection (eight needed). Catalog no. E1701, \$1.10 each. The Woodworkers' Store, 21801 Industrial Blvd., Rogers, MN 55374. Phone 612/428-2199 to order.
- **Magnetic catch.** Catalog no. D4185, 85 cents each (two needed). The Woodworkers' Store, address above.
- **Hinges.** Solid-brass ball-tip pin hinge, antique finish, loose pin. Catalog no. D1209, \$2.35 per pair (two pair needed). The Woodworkers' Store, address above.
- **Glass.** Hand-blown full antique glass, $\frac{1}{8} \times 6\frac{1}{16} \times 5\frac{9}{16}$ ", \$8.50 a pair (price includes shipping and handling). The Stained Glass Store, 3617 Ingersoll Ave., Des Moines, IA 50312, or call 515/279-4855. 🌿

Project Design: Dave Ashe
Photographs: Hopkins Associates;
Jim Kascoutas; Craig Anderson
Illustrations: Kim Downing; Bill Zaun

GUARANTEED FOR... A LIFETIME!

Since 1926, this old tool maker has made Quality products Affordable for the home-craftsman. We are proud to continue in this tradition with the introduction of our new line of woodworking Power Tools... Guaranteed To Last A Lifetime! You'll find the same heavy-duty construction and precision engineering throughout these American Made products that you've come to know and expect from Foley-Belsaw. We invite you to compare the quality and features of our new line of Power Tools with those costing hundreds of dollars more. We're confident you'll appreciate the quality and workmanship we've combined to provide a lifetime of performance in a Power Tool you can afford to enjoy using in your own home workshop.

MODEL 480 14" BANDSAW

The Model 480 Bandsaw gives you the outstanding performance required for every type of bandsawing operations. Contour cutting, straight cutting, resawing, or stack sawing... are all easily handled by the Model 480. Its large $13\frac{3}{4} \times 13\frac{3}{4}$ inch solid cast iron table offers a side take-out slot that allows us to use a set of solid double trunions located directly under the work load. A $\frac{1}{2}$ HP motor lets you effortlessly make cuts in up to 6" thick material using the standard rip fence.



MODEL 435 20" SCROLL SAW

Unlock your creativity with our new Model 435. Features like an extra large 20" throat and 2" depth of cut, combined with a chuck that allows the blade to rotate a full 360°, a 12" x 12" cast iron work table that tilts from 0° to 45° left or right, a variable speed control for the motor that adjusts cutting speed from 600 to 2,000 strokes per minute, and your creative genius becomes almost endless.

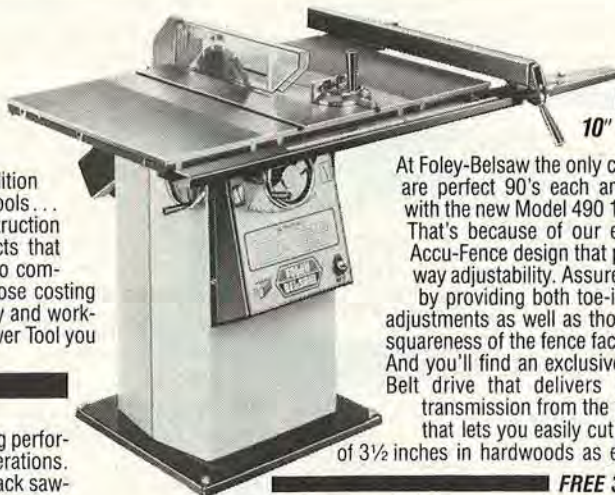

MODEL 490
10" TABLE SAW

At Foley-Belsaw the only corners we cut are perfect 90's each and every time with the new Model 490 10" Table Saw. That's because of our exclusive new Accu-Fence design that provides four-way adjustability. Assures square cuts by providing both toe-in and toe-out adjustments as well as those for perfect squareness of the fence face to the table. And you'll find an exclusive new Poly V-Belt drive that delivers ultra smooth transmission from the $1\frac{1}{2}$ HP motor that lets you easily cut up to a depth of $3\frac{1}{2}$ inches in hardwoods as easily as pine.

FREE 30-DAY TRIAL

When you buy from Foley-Belsaw, you're buying direct from the factory. This provides you with the lowest possible prices for quality, American made Power Tools... guaranteed to last a lifetime! Backed with our 30-Day FREE Trial Money Back Guarantee... you'll get to use these fine Power Tools in your own home workshop for a full thirty days. If you're not 100% satisfied we simply refund your deposits upon return of the equipment. So if you'd like to get all the facts on Foley-Belsaw Power Tools, just clip the coupon and mail it off today! We'll rush you full details along with our "Tailored To Fit Any Budget" payment plans.



Foley-Belsaw Company
42012 Field Bldg.
Kansas City, MO 64111

YES, please send me information on your complete line of Power Tools and full details on how I can qualify for a 30-Day Trial right in my own shop. I understand there is no obligation.

NAME _____
ADDRESS _____
CITY _____
STATE _____ ZIP _____

SAVE UP TO 80% WITH **AMT** POWER TOOLS

Please send me the units checked.

Payment in full enclosed \$ _____
 \$5.00 deposit each item enclosed, balance C.O.D.
 Charge my MasterCard Visa
 Card No. _____
 Expiration Date _____
 Signature _____
 Name _____
 Address _____

Model No. 2731 — 12" Swing, 4 ft. Lathe \$68.85
 Model No. 2731B — Ball Bearing Model \$79.75
 Model No. A439 — Face Plate \$5.55
 Model No. 4390 — 15" Scroll Saw \$149.00
 Model No. 271 — Belt Sander \$54.50
 Model No. A388 — Disc Sander Attachment \$15.75
 Model No. A409 — Mitre Gauge for Sander \$3.20
 Model No. A437 — Wood Lathe Speed Changer \$39.95
 Model No. A607 — 4-Jaw Lathe Chuck \$49.65
 Model No. A631 — 10" Caliper Set \$21.75
 Model No. A411 — General Electric Motor \$43.45
 Model No. A500 — Set of 8 Chisels in Carton (not shown) \$27.40
 Model No. A635 — Set of 10 Chisels in Wooden Case \$47.30
 City _____ State _____ Zip _____

FANTASTIC VALUES . . . OUTSTANDING QUALITY!



INDUSTRIAL SIZE 12" SWING 4 FT. WOOD LATHE
 DOES WORK OF \$200 UNITS
\$68.85 ~~\$127.75~~
 Complete as shown. f.o.b. factory. Shipping Wt. 30 lbs.
 Model No. 2731 — Comparable in speed, precision and durability to units selling for \$200 and more. 36" between centers. For wood and plastics. Tubular steel bed rails with dual point suspension increase accuracy, ease of operation. Precision ball thrust cup center, heavy spur center, graduated T-rest, 3-Speed pulley for different work diameters. Model No. 2731B — Heavy-duty ball-bearing model \$79.95. Model No. A439 — Faceplate (optional) for turning bowls, lamp bases, etc. \$5.55 **10-YEAR LIMITED WARRANTY***



15" SCROLL SAW
\$149.00 ~~\$200.00~~
 f.o.b. factory. Shipping Wt. 44 lbs.
 European Construction Features Rear Spring Design
 Model No. 4390 — The beauty of this rear tension design is its speed and accuracy of cutting and its amazing resistance to blade breakage. The cutting action occurs on the downstroke and the teeth move slightly back from the workpiece on the upstroke (similar to the old time "walking beam" action). Heavy cast iron table and base. The motor provided is a rugged, long lasting induction type.

PRECISION 4" x 36" BELT SANDER
\$57.00 ~~\$54.50~~



Model No. 271 — The world's most talented belt sander. Heavy cast iron sander has belt track and tension control, includes 4" x 36" standard sanding belt. Changes from horizontal to vertical sanding in seconds. Uses 1/3 HP or larger motor. **10-YEAR LIMITED WARRANTY***
 f.o.b. factory. Shipping Wt. 15 lbs.
 Model No. A388 — Disc Sander attachment including disc, bracket, ground cast table (tilts 0-45°); \$15.75 add'l.

WOOD LATHE SPEED CHANGER
\$39.95

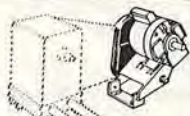

Reduces speed for controlled turning of large diameter workpieces.
 Model No. A437 — Produces rotation speeds of 1380 RPM to as low as 345 RPM when used with a 1725 RPM motor and 3-step pulley (4", 3" and 2"). Speed changer pulleys turn on two double-sealed, lubricated-for-life ball bearings. Shipped complete with 2" x 1/2" machine pulley. **10-YEAR LIMITED WARRANTY***
 f.o.b. factory. Shipping Wt. 9 lbs.

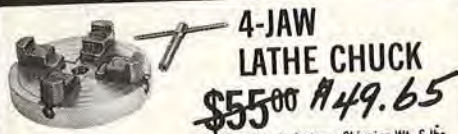

4-JAW LATHE CHUCK
\$55.00 ~~\$49.65~~
 f.o.b. factory. Shipping Wt. 6 lbs.
 Model No. A607 — This 4-jaw lathe chuck is ideally suited for handling round, square, or irregularly shaped stock. Cast iron body has four independent black steel jaws that grip tightly for outside chucking, reverse for inside chucking. Outside diameter adjusts from 7/16" to 5", inside from 7/8" to 6". Fits all AMT lathes or any lathe with 3/4" x 16 headstock spindle.

DIRECT FACTORY OFFER AND REVOLUTIONARY PATENTS decrease costs, increase efficiency. Full scale power tools of heavy duty 100% cast iron and steel. Streamlined design reduces weight, cuts material and production costs. Special patents provide added efficiency, accuracy, savings. **ENDORSED BY AMERICA'S TOP MAGAZINES . . . OVER 2 MILLION USERS** confirm their precision, versatility and rugged performance.
***10-YEAR LIMITED WARRANTY.** Any part or parts of any AMT power tool which become inoperative for any reason within 10 years of the purchase date will be repaired or replaced by the factory. Your only cost is return postage.
****Except motors to which the same terms for one year warranty will apply.**

10-DAY MONEY BACK GUARANTEE
 Try any AMT power tool for 10 days. If not fully satisfied, return for full refund of purchase price. We will pay return freight.
10" CALIPER SET



\$21.75 ~~\$23.50~~
 Model No. A631 — Achieve accurate and reliable measurements on all lathe turning projects with this 10" caliper set. Each of the tools in the set features a positive outside action adjusting nut (free-spinning for quick setting), flexible bow spring, and high-quality steel arms. Includes 10" inside and outside calipers, a 10" divider and a wooden case. f.o.b. factory. Shipping Wt. 3 lbs.

RELIABLE POWER
 AMT/G.E. Electric Motor
 Develops 1 HP 1725 RPM



\$49.50 ~~\$43.45~~
 1/2" shaft
 Model No. A411 — We don't manufacture our own motors but we do recommend this GE model as a dependable power source for any AMT tool. 1-year limited warranty. f.o.b. factory. Shipping Wt. 17 lbs.

TURNING CHISELS



High quality turning chisels handcrafted to exacting metallurgical standards.
10-YEAR LIMITED WARRANTY*
 Model No. A500 — Set of 8 includes two skewers, three gouges, parting tool, round nose, and spear joint (not shown) furnished in carton.
\$31.00 ~~\$27.40~~
 f.o.b. factory. Shipping Wt. 5 lbs.
 Model No. A635 — Master set of 10 in wooden case as shown includes shapes described in set of 8 plus inside turning tools.
\$49.00 ~~\$47.30~~ f.o.b. factory. Shipping Wt. 7 lbs.

CRAFTS FAIRS

Continued from page 63

the setup needn't be fancy, but it should be clean, neat, and show off your work at its best.

If the fair happens to be away from where you live, you'll have travel and living expenses. Staying with friends or relatives will enable you to trim these.

If you decide on a juried fair, make sure you submit professional quality slides of your work. For most of us, that means paying about \$100 to a photographer (or bartering for his skills). Business cards also help add to your professionalism. Dropping one in the wrapping with a purchased piece may also result in later sales.

ADVICE FROM THE PROS

Cleat Christiansen has learned to be a photographer, businessman, traveler, salesman, and educator ("because most people don't understand what woodturning is"), to do crafts fairs.

Beginners, Cleat feels, should look to fairs where the management gives them all the help they can — in assigning space, parking, advertising, and all aspects of the show. "Find out how much they do for you, and for your sales," he advises.

Frank Garvelink suggests that first-time exhibitors try a show close to home, to see if they like it, because: "It's not for everyone."

David DiZinno knows you can "bomb out" from time to time at a crafts fair. "You have to take a little bit of rejection, a little failure. So, test the waters. Look for a fair with a good attitude, organization, and advertising."

WHERE TO FIND WHERE THE FAIRS ARE

After you've asked all the questions about which fairs might be good to attend — read, read, read.

● **How to Sell at Arts and Crafts Shows**, by Kathleen D. and Robert L. Schultz, 1985, Sandune Press, P.O. Box 58, Mosca, CO 81146, \$10 postpaid.

Be Your Own Boss and Make \$18.00 to \$30.00 AN HOUR!

● **The Crafts Report**, monthly, one year subscription, \$16.75, from The Crafts Report Publishing Co., Inc., 700 Orange St., Wilmington, DE 19801.

● **Profitable Crafts Marketing**, by Brian T. Jefferson, 1986, \$10.95 plus .95 postage and handling, from The Crafts Report Book Dept., P.O. Box 1992, Wilmington, DE 19899.

● **Sunshine Artists U.S.A.**, monthly, one year subscription, \$20, from Sun Country Enterprises, Inc., 1700 Sunset Dr., Longwood, FL 32750-9697.

● Also contact state travel departments and state arts councils, care of state capitols, for listings of art and crafts fairs.

SALES TAX AND YOU

Selling your work at a crafts fair means retail sales — and sales tax. So, you'll need a state *resale tax number*, available from your state's tax department, to do business. It allows you to buy materials without paying sales tax, and requires you to collect sales tax on items you sell and forward it to the state.

If you sell retail in a state where you don't live, you'll also need to have a resale tax number from that state. And sometimes, counties require tax numbers too, because they collect taxes independently, or on top of, those collected by the state.

Most fairs make it easy for out-of-state exhibitors and send the proper forms to you when they notify you of acceptance. Sometimes, forms are available when you check in. Or, you can write to the tax department of the state where you intend to do business. Check with an accountant before you begin. Tax laws can be complex. ☘

Photograph: Craig Anderson

Find out how by . . . sending now for your Free Lifetime Security Fact Kit!



Your FREE Lifetime Security Fact Kit tells you how to make \$18.00 to \$30.00 an hour in your own Foley-Belsaw Full-Service Saw and Tool Sharpening Business. Your FREE Fact Kit explains how you can:

- be your own **BOSS!**
- work full time or part time, right at home.
- do work you enjoy and take pride in.
- operate a **CASH** business where 90¢ of every dollar you take in is clear cash profit.

And it is *so easy* to learn. Foley-Belsaw gives you all the facts and instructions. No previous experience or special training necessary. All you need is the desire and ambition to be your own boss. Foley-Belsaw tells you everything you need to know to be successful.

There's plenty of business where you live to keep you busy. It doesn't matter whether you live in a big city, small town or a small farm community.

Earn While You Learn

You'll quickly be able to develop the skills necessary to earn a steady income. You'll be able to sharpen all types of saws, garden and shop tools for home, farm and industry.

Profits from your Foley-Belsaw Full-Service Sharpening Business can provide...

... **CASH** for future security or supplemental income
... **CASH** for travel, vaca-

tions, fishing trips
... **CASH** for the things you've always wanted!

And you'll be able to set your own hours and not have to worry about layoffs and strikes. There are no franchise fees. Best of all—age or physical condition is no barrier—any age person can succeed.

You can be like Steve Taylor of Brookville, Ohio, who told us:

"... the first year I grossed \$21,000.00."

Or James B. Jones, of Albuquerque, NM who reported:

"This past summer my sales and service amounted to almost \$6,000.00 a month."

But you've got to get the **FACTS** before you can get started. So **WRITE NOW** for your FREE Lifetime Security Fact Kit. It's yours to keep with **NO OBLIGATION**.



The Foley-Belsaw Co.
20381 Field Bldg.
Kansas City, MO 64111

FREE Lifetime Security FACT KIT



FOLEY-BELSAW CO.
20381 FIELD BLDG.
KANSAS CITY, MO 64111

YES, I want to know more! Please rush my FREE Lifetime Security Fact Kit. No obligation and no salesman will call.

Name _____
Address _____
City _____ State _____ Zip _____
(Area Code) Phone _____



COMPARE
THE
FINEST QUALITY
AT THE
RIGHT PRICE

**NORTHEASTERN
HARDWOODS**

RED OAK
WHITE OAK
CHERRY
HARD MAPLE
WALNUT
and other species

TURNING STOCK
THIN STOCK
FLITCH CUT LUMBER
SPALTED LUMBER
VENEER
CARVING STOCK

FREE CATALOG
WHOLESALE PRICES
NO MINIMUM ORDER

NORTHEASTERN HARDWOODS
P.O. BOX 365 SALAMANCA, N.Y. 14779
716-945-1510

SWINGING CRADLE

EASY TO MAKE WITH



Full-Size Plan

Authentic spindle design straight out of Colonial America. Plans show alternate construction with panel sides. Perfect for baby or use for magazines. Size: 20" x 39" x 30" high. Order plan #166 — \$9.00

CATALOG
180 diff. full-size prof.
furniture plans—\$2.00
(catalog free with order)

FURNITURE DESIGNS, Dept. BS-27
1827 Elmdale Ave., Glenview, IL 60025

BAND SAW BLADES WELDED TO YOUR EXACT LENGTH

WIDTHS	TEETH	PRICE/INCH
1/8" thru 5/8"	3 thru 32	\$.05

**COMPLETE BAND SAW BLADE LINE
INCLUDING SAW MILL BLADES
TO FIGURE PRICE:**

Inch Length x Price/Inch + \$1.85 Weld Charge

MINIMUM ORDER \$10.00 Add \$2.50 per order for packing and shipping. MasterCard and VISA accepted.

TO ORDER Phone or write to:

BUCKEYE SAW COMPANY
P.O. Box 14794, Cinti., OH 45214
1-800-543-8664 (Except Ohio)
1-513-621-2159 (In Ohio)

Wood-Mizer® Portable Bandsaw Mills

CUTTING CAPACITIES
up to 20' long by 3 1/2' diameter

EFFICIENT
less horsepower produces more lumber per log

PRECISE
smooth surfaces and accurate dimensions

SAFE
guarded bandsaw blade

Three models available



Prices from:

\$3,995.00

For catalogs on our complete product lines, send \$1.00 to:

Wood-Mizer® Products Dept. QQ9
A Division of Laskowski Ent. Inc. 8180 W. 10th St. Indpls, IN 46214 (317) 274-1542

Quality EXOTIC WOOD TURNERS

Thick Planks for
Bowls / Squares

CABINET MAKERS

Individually Selected Lumber for
Furniture / Boxes / Inlays

OVER 70 SPECIES

All Inquiries Welcome — Call or Write

The BEREA HARDWOODS Co.

125 JACQUELINE DRIVE, BOX 10
BEREA, OHIO 44017

216-243-4452



RENOVATOR'S SUPPLY®

Manufacturer & Importer of fine hardware, plumbing, and lighting. For catalog, send \$3.00 to:

THE RENOVATOR'S SUPPLY®
4660 Renovator's Old Mill
Millers Falls, MA 01349

"BEST OF SHOW"



Create an heirloom quality cedar-lined chest in your workshop. This handsome raised-panel chest was judged "Best of Show" Sweepstakes Award for Fremont County Fair-1986. Use our plans and detailed instructions to build & finish this chest. Purchase with \$12.00 check or money order from:

FINELINE CREATIVE DESIGNS

105 West 300 North Street
Saint Anthony, Idaho 83445

EDGE JOINING CLAMP

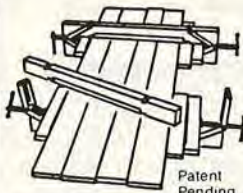

Patent Pending

"DUO-CLAMP"

PROHIBITS
BOWING

- FAST •
- EASY •

**BUTCHER
BLOCKS TOO!**

Holds boards flat while squeezing out excess glue
A perfect mate every time

- NO DOWELING • NO PLANNING
- 30 DAY MONEY BACK GUARANTEE**

16" Capacity \$34.50

26" Capacity \$37.50

36" Capacity \$40.50

MASTER CARD/VISA

FREE U.P.S.

Send for FREE info:

MARK PRODUCTS

Box 46143

Dept W1

Bedford, Ohio 44146



LOW PRICES • HIGH QUALITY
Toll Free Phones! • 1-800-624-3938
In Ill. 1-800-358-4208

Love - Built Toys

The Toymaker Supply Co.

105 Weiler Rd. T34
Arlington Hts., IL 60005

For Volume Purchases of Quality
Toy Parts..Write or Phone Today
For Free Catalog!



WOODWORKERS

Save on Wood - Tools - Supplies!

OVER
4000
ITEMS

Finest Dimensioned
HARDWOODS and
Quality **VENEERS**

42 Varieties 1/4" to 4" Thickness

Fast service on choice kiln dried Wood and Veneers, Moldings, Trim, Hand and Power Tools, Lamp Parts, Upholstery Supplies, Clock Movements and Kits, Hard-to-Find Hardware, Finishing Materials, Books . . . over 4000 items in stock! Craftsman—Woodworker's best friend.

FREE with Catalog
-\$3.00 Discount Coupon
Good on First Order

CRAFTSMAN WOOD SERVICE

Dept. K-17, 1735 W. Cortland Ct., Addison, IL 60101.
Please enclose \$1.00 to help pay postage and handling.

BUILD IT YOURSELF

TOYS • PUZZLES • PLAQUES • PLANTERS
FURNITURE • LAWN ITEMS • BIRD HOUSES
ROCKING & RIDING HORSES • PLAY SETS



BLUEPRINTS

CREATE HUNDREDS OF ITEMS ILLUSTRATED
WITH SAME SIZE PATTERNS PLUS WHEELS AND BOOKS CATALOG \$1

Design Group, Box 514-Z, Miller Place, N.Y. 11764

Wood Moisture Meter

- Avoid Moisture Problems
- Protect your Masterpiece

Mini-Ligno
\$110 only

Pocket-Size: 1 1/2" x 3/4" x 5/8"
Incl. Case, Batteries, and Pins for
3/4" and 1/2" Measuring Depth.

also from Lignomat:

Mini-Ligno E

Range: 6, 7, ..., 36%

Easy to use, sturdy instrument for the professional woodworker or serious hobbyist. Great for lumber, veneer, fiberbrds. Ask for free catalog on all moisture meters and accessories for kiln drying. Don't waste money, time on wet wood, order a moisture meter now.

Lignomat USA Ltd.
503-257-8957 800-227-2105

P.O. Box 30145 bh
Portland, OR 97230



FUN WOOD

Crafts & Toys

Woodworking Plans & Patterns



Doll Cradle
22" Long
Order #Ty-CR-103
\$8.00

Funwood
Crafts & Toys
P.O. Box 5412
Coos Bay, OR
97420

Large 24"
Dump Truck
Order #Ty-Ph-102
\$9.00



Both Plans \$15.00
Brochure only \$1.00

Makita

Call 1-800-2-MAKITA for Low Prices on Entire Makita Line

• FREE FREIGHT •

NEW!
LS1000
10" Miter Box
Saw w/Vise
List \$368
SALE \$196



2708W 8 1/2" Table
Saw w/Carbide Blade
List \$368
SALE \$209

Makita Batteries
7.2 Volt List \$40 **SALE \$28**
9.6 Volt List \$44 **SALE \$30**

Visa • Mastercard
Check • Money Order



3612BR 3HP
Plunge Router
List \$318
SALE \$172

2030
12" Planer Jointer
List \$1980 **SALE \$1099**

TOLL FREE
1-800-262-5482

NEW!

6071DWK
Variable Speed, Cordless Drill
w/7.2 Volt Recharge Battery
List \$172 **SALE \$104**



9501BKIT 4" Sander-Grinder Kit
10,000 RPM List \$119 **SALE \$58**



6012HDW 2-Speed
Cordless Drill w/Batteries & Case
List \$188 **SALE \$96**



HOME LUMBER CO.

449 WHITEWATER ST., WHITEWATER, WI 53190
IN WISCONSIN USE (414) 473-3538

BUILD AN HEIRLOOM CLOCK

Finest Quality Available
Kits, Movements and
Plans

Write or Call for
Catalog \$2
1-800-328-6445
Kuempel Chime
Clockworks

Dept. 012
21195 Minnetonka Blvd.
Excelsior, MN 55331

Serving clockmakers for 65 years



Clamp Onto Low PRICES!

We'll Pay The Freight!

8" KIT - 6.95
10" KIT - 7.95
12" KIT - 8.95
14" KIT - 9.95

2-Wood Handles - \$1.00
Send Check, Money Order,
Visa or MasterCard Number

KIT INCLUDES: 2 Heavy steel ferules with spiral pins -
3/16" A.C.M.E. double lead, threaded rods - 4/8" pivot nuts -
Complete layout with illustrations.

DUBUQUE Clamp Works
527 Garfield • Dubuque, IA 52001

FULL SIZE WOODWORKING PATTERNS

SIMPLE TO MAKE - FUN - PROFITABLE

✓ Check the packets of Interest to YOU!

- 75 pattern packet plus "Shop Secrets"
- Over 50 "Folk Art" patterns
- 8 "Wind-Action" whirligigs packet
- 40 craft plaques plus projects
- 27 toy cars, trucks, train, ferry & more!
- 6 decorative magazine racks

Send \$7.00 per blueprint packet or
choose any 3 FOR ONLY \$14.00.

ACCENTS, Dept. MA17, Box 262, Danvers, MA 01923

Brochure of 500 designs \$2.00 (Free with order)

BUILD THIS CHILD'S WARDROBE

Order plans for this Shaker reproduction

The beauty of this piece is that it "grows" with the child. The 2 closet poles hold toddler clothing now, and when youngster grows into his teens the same 2 poles store blouses and shirts. A very handsome piece - finished in the country manner. Measures 23"d x 42"h x 48"w.

To order plans, send \$10.00 (Canadian residents remit postal money order in US funds) to :
HAMMERMARK ASSOCIATES, P.O. Box 201-E
Floral Park, NY 11002. Send \$1.00 (deducted from your first order) for catalog, included free with all Wardrobe plans orders.



Turning into a better craftsman can be as simple as turning the pages of our new catalog.

Our new 244 page catalog is filled not just with pictures of great hand and power tools, but carefully written specs, detailed illustrations and recommendations from craftsmen who've spent much of their lives making, using and testing tools.

You'll know what they look and feel like, and you'll know how they fit your needs.

We believe you're not the average craftsman. So why should we give you an average catalog?



Garrett Wade Co., Inc., Dept. 505
161 Ave. of the Americas, N.Y., NY 10013

Please send me your 244 page catalog of wood working tools, machinery and accessories. Enclosed \$3.00.

Name _____
Address _____
City _____
State _____ Zip _____

BEST VALUES

IN WOODWORKING MACHINERY

15" THICKNESS PLANER complete with floor stand

Big planing capacity at a reasonable price from the woodworking specialists. Saves time and money. Pays for itself in no time.



14" WOOD LATHE with duplicator and stand



Produce identical copies or singles. For the pro or beginner. Multi speed. Priced for everyone.

EASY TERMS! FREE 45 DAY TRIAL IN YOUR SHOP

Send for complete information! Don't Delay!

GREAT PLAINS MACHINERY CO.

4050 Broadway, K.C., Mo. 64111

- YES! Please rush me my FREE PLANER INFORMATION KIT.
- YES! Please rush me my FREE LATHE INFORMATION KIT.

NAME _____
ADDRESS _____
CITY/STATE _____ ZIP _____

MAKE TOYS AND WHIRLIGIGS

100's of plans, parts, kits, books, finishes & supplies for toys, whirligigs, classic autos, swing sets, doll houses, crafts & furniture. Also toy, craft, game & furniture parts in maple, oak, walnut & cherry. Bulk prices available.

Color catalog subscription \$1.
LIMO KITS (614) 484-4363
\$24.00 Precut: just sand & assemble
\$18.50 Uncut: just cut, sand & assemble
Size: 14" long

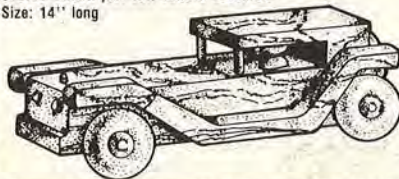

Cherry Tree Toys, Box 369-9, Belmont, OH 43718

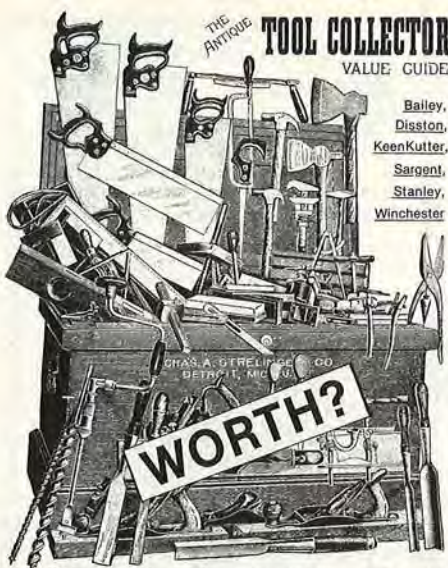

THE ANTIQUE **TOOL COLLECTOR**
VALUE GUIDE

Bailey,
Disston,
KeenKutter,
Sargent,
Stanley,
Winchester

WORTH?

What Are Your Old Tools Really Worth?

Old woodworking tools are one of today's hottest new areas of collecting. Long neglected by all but a few sophisticated insiders, this field is growing rapidly. Several Stanley-Bailey carpenter planes are already selling in the \$500-\$900 range, and an early plow plane sold for over \$6,000 at a recent tool auction. Ronald Barlow has spent the last 3 years working full-time on this guide...amassing photographs, and recording dealer and auction prices from all over the world.

Antique Tool Collector's Value Guide

Just a few of the over 5,000 items described and priced: adzes, anvils, axes, trade catalogs, braces, bitstocks, chisels, cobbler's tools, coopers items, compasses, dividers, hammers, hatchets, knives, lathes, levels, planes, pliers, plumb bobs, routers, rules, saws, scoops, screwdrivers, shears, spoke shaves, surveying instruments, tinsmiths tools, trammel points, wrenches, and wheelwright's items. Over 2,000 illustrations. 1st Ed. • 230 pgs. • 9X12 paperback • Library of Congress #84-50055.

NOW IS THE TIME to identify and price all of your old tools. Just one find could pay for this new book, many times over! Rush check or money order - \$12.95 plus \$1.05 postage.

WINDMILL PUBLISHING COMPANY
2147 Windmill View Rd., Dept W2 - El Cajon, Calif 92020

NATIONAL WORKING WITH WOOD SHOW

For the amateur and professional craftsmen.
3 BIG SHOWS!

LOUISVILLE, KY
Commonwealth Convention Center
FEBRUARY 20-22, 1987

PASADENA, CA
Pasadena Civic Center
FEBRUARY 27-28, March 1, 1987

BOXBOROUGH, MASS
Sheraton Inn
MARCH 13-15, 1987

Machinery • Power & Hand Tools
Supplies • Workshops • Free Seminars
Admission \$5 (\$1 OFF with This Ad)
For more info call (408) 973-0447

Full Size Plans



Build these two great **Fords**. The Model A is 11". The Pickup is 12". Two plans per set. Plan No. 18010....\$8.50. Catalog \$1.00 or free with order. Visa/MC (516) 462-6228.

ARMOR, Dept. L, Box 445, E. Northport, NY 11731

BRANDING IRON FREE SHIPPING

Call toll free anytime to order your BrandMark

(orders only)

1-800-237-8400 ext. 720

in Florida **1-800-282-1469 ext. 720**

Mention this Advertisement and receive \$3.00 off the regular price.

Your Satisfaction Guaranteed

- Convenient torch heating
- Solid Brass—lasts years
- 1st line as shown
- 2nd line—18 letters/spaces max.
- 1/4" letters
- distinctive border
- \$31.00 ppd
- OH res. add \$1.71 tx



Order by mail from **BrandMark**



462 Carthage Dr. • Dept W • Beavercreek, OH 45385
513-426-6843

THIN HARDWOOD PRICED RIGHT

Clear • Kiln-dried • 2 Sides Surfaced
3" to 10" Widths • 3' to 5' Lengths
20 sq. ft. Packs, Random Widths & Lengths



1/2" red oak...\$36.00 pkg.
1/2" walnut.....\$44.00 pkg.
1/2" pecan.....\$29.00 pkg.
1/4" & 3/8" also available at same price.

Price includes UPS delivery.
Send Check or M.O. with order.

HARDWOODS OF ILLINOIS
RR4, Box 618, Mt. Vernon, IL 62864



Five Cutting Boards

Build these handy boards from hardwood scraps. Sizes range from 9"x6" to 12"x17".

PLAN #4851-W \$4.95
OUR NEW CATALOG ... \$2.00
POST. & HANDLING ... \$1.50
TOTAL
Catalog price is refundable with next order. Iowa residents add sales tax.



P.O. BOX 65725, WEST DES MOINES, IA 50265

ATTENTION FLORIDA WOODWORKERS

We have Florida's largest and most unbelievable selection of exotic imported and native hard and soft woods, table slabs, veneers, etc. We also stock Ashley Isles carving tools. Send self-addressed stamped envelope for list.

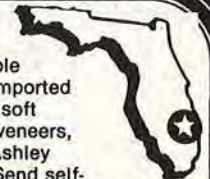

HENEGAN'S WOOD SHED

7760 Southern Boulevard
West Palm Beach, FL 33411
Call (305) 793-1557
Open Tues.-Sat. 9:00-5:30

Avoid delays in the delivery of your **WOOD** magazine.

Please let us know, at least five weeks before you move, what your new address will be.

STONE MOUNTAIN

POWER TOOL CORPORATION

Post Office Box 2825
Norcross, GA 30091
404-446-8390

Call for current prices on any item

While quantities last.



S-500A
Orbital palm sander
12,000-O.P.M. 1.5 Amp
*Delivered **\$29.00**

JSE 60

Jig Saw Electronic
Variable Speed
3.5 Amps
1,000-2,700 SPM
\$69.00 *Delivered

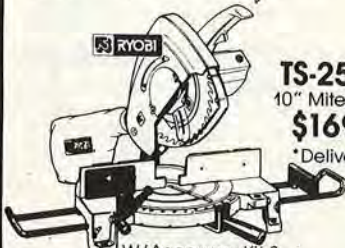

TS-251U
10" Miter Box
\$169.00
*Delivered

W/Accessory Kit & 60T Carbide Blade
\$199.00 *Delivered

Visa / MasterCard, Check or Money order.
*Delivered to 48 States

WOOD WORDS

 Print this article

Abrasive: In woodworking, material used for smoothing the surface of wood or polishing layers of finish after application. Forms include powder (rottenstone), paste (rubbing compounds), coated paper (sandpaper), and steel wool.

Aluminum oxide: A common synthetic abrasive used as the cutting agent on coated papers. Other often-used abrasives include silicone carbide, flint, and garnet.

Bead: Glue applied in a line; also refers to the small bulbous mass of glue forced from a joint under clamping pressure (squeezeout). Used additionally to describe a small, round wood molding formed by a beading bit.

Bow: A warp in which the ends of a board or wooden member curve in the same direction away from the desired plane, usually along the length.

Cove: A molding or shaped piece that has a concave cross section; to make such a cut.

Edge grain: Wood characterized by the growth rings being 45 or more degrees, preferably perpendicular, to the surface of a board; the face grain produced in quarter-sawn wood.

Edge grain

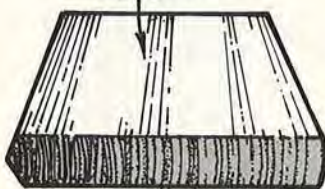

Quarter-sawn wood



Face grain: The pattern made by growth rings in wood on the greatest surface of a board, or on the superior side of a sheet of plywood.

Continued on page 94

The workbench companion



WATCO®

The Original and Still the Best

DANISH OIL FINISH

Watco Danish Oil Finish can be your ideal workbench companion for all those wood finishing projects around the house. You'll be amazed at how easy it is to finish wood beautifully with Watco, "The Original Danish Oil". Watco gives wood that natural, hand-rubbed look with long-lasting durability. And because Watco is **IN** the wood... not on it like temporary surface coatings... there is no finish that will wear off. Watco Danish Oil is ideal for furniture, paneling, cabinets, doors, trim-work and even antiques. It's also safe for use on butcher blocks, cutting boards, and children's toys after Watco dries and cures in the wood. Choose from 8 beautiful finishes... Natural and Medium, Dark, and Black Walnut shades, and Cherry, Golden Oak, Fruitwood, and English Oak colors.

Send today for "Free" color booklet "How to Finish Wood Beautifully and Easily" and the name of your nearest Watco distributor.

WATCO-DENNIS CORP., Dept. BH-W27
1433 Santa Monica Blvd., Suite 90
Santa Monica, CA 90404

Name _____
Street _____
City _____
State _____ Zip _____

**NEW
POWER
FEED**

DRUM SANDER



At last! A complete power-feed Drum Sander at an affordable price! Comes ready to use including hood, stand and motor! Choose from 12" and 26" models.

FINISH SANDING...THICKNESS SANDING

Use this high-tolerance machine for light dimensioning as well as the finest finish work. Now you can add new beauty to each woodworking project...save hours of tedious hand sanding! In a matter of seconds, you can produce a satin-smooth finish impossible to duplicate with hand methods or hand-held power sanders...no more low spots, waves or cross-grain marks!

IMPROVES RESULTS!

Send for complete facts! See how the Sander can dimension and finish-sand cabinet pieces, resawn stock paneling, grandfather clocks, toys, tabletops, knees, burls, crotches, and much, much more! You'll soon find it's one of the most valuable tools in your shop! **Made in U.S.A. Easy terms.**

Call Toll-Free 1(800) 538-4200, ext. 2416

**SANDER
FACTS**

YES! Please rush my **FREE INFORMATION KIT** and details on your 30-Day Free Trial Guarantee. Woodmaster Tools, Dept. RW16 2908 Oak, Kansas City, MO 64108

NAME _____

ADDRESS _____

CITY _____

STATE _____ ZIP _____

Free 30 Day Trial!

Send for complete facts on how you can try the Woodmaster Power-Feed Drum Sander in your own shop for 30 days completely without risk!

DELTA

VERSATILE! BIG CAPACITY!
NEW DELTA 16"
MOTORIZED BAND
SAW



LIST PRICE \$467

\$399

Cuts wood, plastic, aluminum, sheet metal • Capacity-16", 8" under sawguide • 3-wheel drive with speeds of 450 and 2400 SF/M • Rigid, C-type, cast iron frame • Big 16" x 16" cast iron table tilts 45° • Ball bearing blade guides

28-560

Complete with stand, 1/2 HP Motor, Rip Fence & Miter Gauge.



14" BANDSAW

28-243

1/2 HP or 3/4 HP Motor Available

Less Motor..... **\$475**

- LIMITED OFFER
- FREE SAME DAY SHIPPING
- FACTORY AUTHORIZED SERVICE
- FULL LINE DISTRIBUTOR



28-160

10" BANDSAW

1 PH, 1/5 HP Motor

LIST \$158..... **\$124**

CALL ABOUT THE ALL NEW LUMBER COMPANY

a c m e Electric

TOOL CRIB OF THE NORTH SINCE 1948

CALL TOLL FREE FOR MIKE



1-800-358-3096



KILN DRY YOUR OWN LUMBER

nyle corporation

the nation's largest manufacturer of dehumidification dry kilns is now offering small 500 to 10,000 board feet drying systems.

- ★ Made completely in the USA
- ★ The leader of the industry
- ★ Offering excellent warranties
- ★ Expert consultation and service

nyle DRY KILN SYSTEMS

Box 1107-A, Bangor, Maine 04401
Telephone 1-800-648-9200
or 207-989-4335

Information



Send for hundreds of useful low-cost catalogs, booklets and ideas, especially prepared to help you with your woodworking projects.

Complete the coupon on page 109 and send with your remittance to our WOOD MAGAZINE processing center.

Special section starts on page 107.

**MAIL
YOUR
ORDER
TODAY!**

**TIRED OF BREATHING SAWDUST?
FED UP WITH SHOVELING SHAVINGS?**

Finally, an affordable
DUST COLLECTOR
for your small
shop!



\$299.95
plus \$6.00 shipping

Makita's new dust collector is a compact, portable unit capable of handling machines as large as a 16" planer. Its 9 amp, 10,000 rpm motor drives a high-efficiency centrifugal fan for peak air flow of 307 cfm through a 3" hose providing high velocity for minimal clogging under heavy load. Comes with a huge 8 cubic ft. dust bag, or can be ducted into other containers as desired. Weighs only 20 lbs. - easily moved from one machine to another.

Why spend another day working in a messy, cluttered shop? Send \$299.95 plus \$6.00 shipping (check or M.O.) and we'll rush your Makita 410 dust collector to you via UPS. We include 8 ft. of heavy-duty flexible 3" hose, along with information on procuring dust hoods for your tools, or making your own from plywood or sheet metal. One year factory warranty. We guarantee you will be satisfied. (If not, return it to us postage prepaid within 30 days, and we will refund your \$299.95).

MC/Visa Users outside Ga.
ORDER TOLL FREE
(800) 241-6748
(Orders Only)

Call or write for
free brochure.

highland hardware

1045 N. Highland Ave., NE Dept. B
Atlanta, GA 30306 (404) 872-4466

GREAT VALUE FROM CANADA



DELTA (ROCKWELL)

★ 34-457SXF Unisaw 3 HP Single phase Motor and magnetic control (unifence model)

USD \$1,299.00

LEIGH DOVETAIL JIGS

- ★ 1258 - 12" DELUXE MODEL **\$239.95**
- ★ 1258 - 24" DELUXE MODEL **\$289.95**

CARBIDE ROUTER BITS INCLUDED

RECORD

- ★ 04 SMOOTHING PLANE 9 3/4" **\$ 29.95**
- ★ 05 JACK PLANE 14" **\$ 34.95**
- ★ 07 JOINTER PLANE 22" **\$ 59.95**
- ★ SET OF 3 ABOVE **\$114.95**
- ★ 148 DOWELL JIG COMPLETE **\$ 39.95**

All orders over \$50.00 prepaid
with exception of Delta Unisaw (Freight Collect)

HOUSE OF TOOLS LTD.



131-12TH AVE. S.E.
CALGARY ALBERTA
CANADA T2G 0Z9

PHONE (403) 269-7365

BOSCH Power Tools

Jig saws
only \$125.00



Model 1581VS

#0.	TOOL	SALE
1582VS	Orbit. Action Nob Hdle Jig Saw	\$118.00
3238VS	Unv. Shank Mult. Orbit. Jig Saw	83.00
1601	1 hp Router	89.00
1602	1 1/2 hp Router	129.00
1604	1 1/4 hp Router	118.00
1606	D-Handle, 1 1/4 hp Router	163.00
90300	Fixed Base Router, 3/4 hp	350.00
90303	Plunge Base Router, 3/4 hp	472.50
90085	3/4 hp Router	91.00
3270D	3x21 Dustless Belt Sander	119.00
1272	3"x24" Belt Sander	159.00
1272D	3"x24" Belt Sander w/Dust Collector	169.00
1273	4"x24" Belt Sander	169.00
1273D	4"x24" Belt Sander w/Dust Collector	179.00
1921VSRK3/8"	Var. Spd. Screwdriver	115.00
1920VSRK3/8"	Cordless Reversing Drill	99.00
1920RK	3/8" Cordless Reversing Drill	85.00
3268	Heat Gun	48.00
1158VSR	3/8" Var. Spd. Rev. Drill	54.00
1651	New Bosch 7 1/4" Cir. Saw, 13 amp	99.00

MAKITA-HITACHI

F1000A	Planer Jointer	1275.00
2030M	Planer Jointer	1420.00
8600A	Bandsaw	1400.00

CALL TOLL FREE
1-800-525-0750

VISA and MASTERCARD ACCEPTED

AVIATION/INDUSTRIAL SUPPLY
P.O. Box 39159 • Denver, CO 80238
TOOLS FREIGHT PAID

PRICE SHOCK!



GENERAL

Machine Only	AS LOW AS
#350-1 10" Table Saw	\$920.00
#160-2 Variable Speed Lathe	825.00
#260-1 Variable Speed Lathe	1725.00
#1180-1 6" Jointer & Stand	535.00
#480-1 8" Jointer & Stand	1075.00
#490-1 15" Bandsaw & Stand	605.00
#130-1 14" Thickness Planer	1935.00

The Humfrey Catalog brings you concise descriptions & detailed, large-format photographs of machines representing a tradition of solid craftsmanship... all at factory-direct prices. Send for your copy now.

J. Philip Humfrey Ltd.

3241 Kennedy Road, Unit 7
Scarborough, Ontario M1V 2J9
(416) 293-8624

A Shophelper
PRODUCT

"Those Yellow Wheels..."
ANTI-KICKBACK STOCK FEEDER

NEW
IMPROVED!

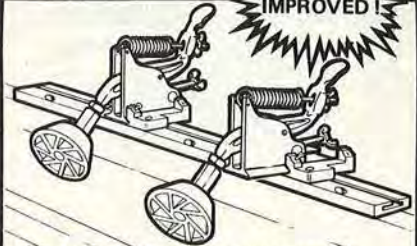

FOR USE ON: TABLE OR RADIAL SAWS,
SHAPERS, JOINTERS, ROUTER TABLES, ETC.

- HOLDS STOCK DOWN AND AGAINST FENCE
- MINIMIZE BINDING, CHATTER AND KICKBACK
- QUICKLY AND EASILY MOVED FROM MACHINE TO MACHINE
- ENSURE OPERATOR SAFETY
- WHEELS INTERCHANGEABLE BETWEEN MODELS
- NEW CONTINUOUS HEIGHT ADJUSTMENT FOR IMPROVED PRECISION
- NEW WHEEL DESIGN
- NEW SLOTTED TRACK FOR HORIZONTAL ADJUSTMENT
- NEW HEAVY DUTY SPRING LOADED ARM
- NEW DOVETAIL BRACKET FOR SMOOTHER ADJUSTMENT

Set complete with brackets \$79.50
24" track, 2 gibs, hardware \$29.95
12" track, 1 gib, hardware \$16.95
(Additional mounting brackets available)

Mfg. by Western Commercial Products
For nearest dealer or to order, call:
800-344-7455; CA 800-828-8833
Or write: P.O. Box 238, Tulare, CA 93275
DEALER INQUIRIES INVITED

WHAT GOES UP, BETTER COME DOWN.

Many of the 60 million Americans who have high blood pressure don't know it. You could be one of them. So call the Red Cross and have your

blood pressure checked. Because high blood pressure means a high risk of heart attack or stroke. And, unfortunately, the law of gravity doesn't affect it.



 American Red Cross

WOODWORKING WORLD SHOWS



3 EXCITING EVENTS!

MANY BRAND NEW EXHIBITORS WITH THE NEWEST & LATEST PRODUCTS FOR WOODWORKERS!

THE TORONTO SHOW

Friday, January 16 - 5pm - 9pm
Saturday, January 17 - 10am - 6pm
Sunday, January 18 - 10am - 5pm

The Skyline Toronto Hotel

655 Dixon Rd., 1 Mile From Toronto Airport
Rexdale, Ontario

THE COLUMBUS, OHIO SHOW

Friday, February 13 - Noon - 6pm
Saturday, February 14 - 10am - 6pm
Sunday, February 15 - 10am - 5pm

Veteran's Memorial Hall

300 West Broad St., Columbus, OH

THE WASHINGTON-BALTIMORE SHOW

Friday, February 27 - 5pm - 9pm
Saturday, February 28 - 10am - 6pm
Sunday, March 1 - 10am - 5pm

Sheraton Hotel & Convention Center
Exit 20B off Capitol Beltway, New Carrollton, MD

— FREE SEMINARS —

ADMISSION CHARGED

FOR INFORMATION:

Convention Designs, Inc., P.O. Box 485, Plymouth, NH 03264
(603) 536-3768

RING MASTER

"The second new idea in power woodworking to come along in 100 years."

Cut Perfect Rings In Any Wood...
any angle, any size up to 1" thick, 12" diameter.

1

Cut flat wood into angle or straight-edged rings, stack the rings and create ANY HOLLOW CYLINDRICAL SHAPE... Just glue, sand and finish... create matched sets of items.



Ring Master is simple to operate. Only 2 adjustments to set up, 3 operating steps to cut rings.

In just two years Ring Master is the center of attention in SCHOOLS, BUSINESS, and HOMES, AND is a welcome profit-maker for many -

NOW Ring Master Model 2 works on your Shopsmith® Mark V. OR SIMILAR MACHINE - attaches in 15 seconds.



Mr. B.W.H. of Santa Barbara, Cal. recently wrote about the Model 2; "Ring Master - is a new and fantastic machine - it fit(s) on the Shopsmith, it has simplicity and durability incorporated into it - I find it a tremendous addition to my woodworking shop."

3 To request a color brochure or to order - PHONE TOLL FREE 1-800-854-9815, in Florida 305/859-2664. We honor Visa, Master Card, personal check and COD.

Ring Master, Inc.
P.O. Box 8527A, Orlando, FL 32856, 305/859-2664
Please send me complete facts about the ALL NEW Ring Master.
Name _____
Address _____
City _____ State _____ Zip _____
Ring Master DEALERS wanted in all areas.

NOW! Get in on the PROFITS in

SMALL ENGINE REPAIR!



Start your own money making business!

Work part time, full time - right at home - we help you every step of the way.

No doubt about it... as a small engine pro, you can cash in on the huge demand for qualified men in one of America's fastest growing industries. You'll be able to command top hourly rates of from \$25.00 to \$30.00 per hour - and that's just for labor. A simple tune-up earns as much as \$49.95 for less than an hours work, and parts, engines and accessories will add even more to the profits.

Plenty of business waiting for qualified men. 65,000,000 Small Engines Are In Use Today! That's the official count from the Engine Service Assn., and one-million new engines are being built each month. With fully accredited Foley-Belsaw training, you can soon have the skills and knowledge to make top money servicing these engines. People will seek you out and pay you well to service their lawnmowers, tillers, edgers, power rakes, garden tractors, chain saws, minibikes, snowmobiles, generators, go-carts, paint sprayers, snowblowers... the list is almost endless.



Professional Tools and Equipment, PLUS 4 H.P. Engine ALL YOURS TO KEEP... All at No Extra Cost. NO EXPERIENCE NECESSARY!

You don't need to be a 'born mechanic' or have any prior experience. You can master this profitable trade right at home in your sparetime. Lessons are fully illustrated...so clear you can't go wrong, and with our famous 'learn-by-doing' method you get practical 'hands-on' experience. We also show you how to get business, what to charge, where to get supplies wholesale...all the inside tricks of the trade you need to assure success right from the start.

Send for FREE Facts - Do it TODAY! NO Obligation - NO Salesman Calls!

You risk nothing by accepting this offer to see how easily you can learn the skills you need to increase your income in a high-profit business of your own. Just fill in and mail coupon below (or send postcard with name and address) to receive full information by return mail.

RUSH COUPON TODAY
Foley-Belsaw Institute
51059 Field Building
Kansas City, MO 64111



FREE BOOKLET!
Send for your copy today!

FOLEY-BELSAW INSTITUTE
51059 FIELD BUILDING
KANSAS CITY, MO 64111



YES, please send me the FREE booklet that gives full details about starting my own business in Small Engine Repair. I understand there is No Obligation and that No Salesman will call on me.

NAME _____
ADDRESS _____
CITY _____
STATE _____ ZIP _____

WOOD WORDS

Continued from page 91

Forstner bit: A patented drill bit for sinking holes which do not penetrate all the way through the material. Used for holes requiring a flat bottom. The sharpened circumference decides position.

Gain: A rectangular cut across the grain in a workpiece; also called a dado.

Grain direction: The direction in which the dominating, elongated fibers or cells lie in the structure of wood.

Hone: To polish and refine a cutting edge by rubbing it against a hard, smooth stone or other surface made for that purpose.

Hammering: Vibration and noise caused by feeding a workpiece into a circular saw or dado blade too rapidly, or by using a dull blade.

Moisture content (MC): The percentage of water a piece of wood contains. Normally, kiln-dried lumber has a moisture content of 6 to 9 percent.

PEG: Polyethylene glycol, a preservative for treating green wood to prevent splitting or checking by chemically replacing the natural drying process.

Straight grain: Grain running parallel to the length of edge of a board.

Turning: The skill of using a lathe and lathe tools to produce rounded wood pieces, usually of varying thickness, such as furniture legs and bowls. Also used as a term to describe a product made on a lathe.

Warp: A general term used to describe the deviations in the shape of a board from the true or plane surface. Caused by uneven drying, warps include bows, crooks, cups, twists, or a combination of these configurations. 🌲

IF YOU VALUE YOUR FINGERS.....

YOU NEED A RIPSTRATE®

The RIPSTRATE holds the work tight against the fence with no hands near the blade. Makes perfect, straight cuts. Wheels lock to prevent kickbacks. *Requires no adjustment for stock width or thickness.*

Over 20,000 now in use in amateur, professional, school, government, military, and corporate maintenance shops.

One year guarantee, 30 day money back trial. \$69 prepaid. Check, M.O., Visa or M.C. Free Brochure.

Write or call our toll free number: 800-421-0256.

Fisher Hill Products 4 Fisher Hill Fitzwilliam, NH 03447
Dealer inquiries invited.



**ELEKTRA
BECKUM**



THE PERFECT
COMBINATION

**BAS450 BANDSAW 'and'
SPA1000 DUST EXTRACTOR**

- 18" Throat w/ 12" height
- 4 speeds:(260-690-1470-3800 fpm)
- 3/16"-1" blade width
- Heavy-duty 3-roller guide assembly standard
- 1.5HP continuous-duty motor
- A clean work environment
- 765 cfm suction capacity
- 4" x 98" heavy duty hose
- Use any standard trash bag
- 3/4 HP motor 110/1/60

\$495.00

\$1535.00

Suggested list price
FOB Somerdale,NJ



Send \$1.00 for full color catalog to:
ELEKTRA BECKUM USA DEPT BAS
PO BOX 24, SOMERDALE, NJ 08083
Call for your local dealer: 1-800-223-8600
See these machines demonstrated at:
Denver, Feb 13-15; Columbus, Feb 13-15;
Milwaukee, Feb 20-22; Wash.DC Feb 27-Mar

MOLD, PLANE and EDGE

**-In Your Shop
or On the Job!**

Spectacular Savings and FREE 30-Day Trial from Williams & Hussey.

For as little as \$725.00 you can own a complete Williams & Hussey Molder/Planer System—the machine, the motor, our portable custom stand, and a Free sharpening certificate. You save \$115.00 just by writing for your FREE information kit.

100% American Made to Keep You in Business!

We've packaged our rugged, dependable W-7 Series Molder/Planers into a complete system that turns rough-cut boards into smooth, saleable items you can be proud of:

Picture Frames • Crown Moldings • Raised Panels • Boat Decks • Casings • Sashes • Rails

And the system keeps on working thanks to cast-iron construction and an iron-clad five-year warranty! Depend on us for fast shipping, courteous service, and the rugged product quality that's kept W-7 Series owners on the job and working for more than thirty years.

5-YEAR WARRANTY

100% American Made • Caster-Mounted Stand • Cast-Iron Base & Head • Chrome Steel Posts • Serrated-Steel Roller • 2-Minute Changeover

FROM
\$725
COMPLETE



**Free
30-Day
Trial!**

Cuts Any Molding, Planes Any Hardwood

Duplicates thousands of moldings from 7" wide to 3/4" deep, cuts 15 feet per minute—even rock maple! Edges any width board thanks to the open-sided design!

Super-Fast Changeover

Convert your W-7 Molder to Planer in less than 2 minutes. No gauges or special tools needed. Blades bolt on and off—no arbor changes required!

Thousands of Blade Patterns

Just about any molding knife you need—custom models, too! And we ship our off-the-shelf blades within 48 hours. Need a special knife? Send us a tracing, and we'll make it for you!

Choice of Three W-7 Models

Save \$115.00 on all three systems: power infeed/outfeed, power infeed only, or manual operation. Each model includes a set of the finest-quality high-speed steel blades, the all-steel, caster-mounted moveable stand, plus the rugged 1.5-hp. Baldor motor for years of dependable service.

THE COMPLETE MOLDING/PLANING SYSTEM

- W-7 Series Molder/Planer • All-Steel Roller-Mounted Stand
- Rugged 1.5-HP Baldor Motor

—plus your FREE \$15.00 knife-sharpening certificate!

Williams & Hussey Machine Co., Elm Street, Dept. 236JP, Milford, NH 03055

BUILT TO GO THE DISTANCE

1-800-258-1380 In NH 603-673-3446

Yes! Please rush specs on the W-7 Series Molder/Planers.

Name _____

Street _____

City _____ State _____ Zip _____

Williams & Hussey Machine Co., Elm Street, Dept. 237AP, Milford, NH 03055.

Save \$115 - Call or Write for FREE information today!

THE RBI HAWK LINE OF PRECISION SCROLL SAWS

Let the RBI Hawk line of Precision Scroll Saws unlock the creativity in you and let you become the woodworker you want to be. Use your Hawk to cut out in almost any material,



names, wooden toys, cut-outs for tole painting, silhouettes, inlays, trivet baskets, the list is limitless! We built the quality into the Hawk that the pro's demand, yet kept it simple enough for a beginner to use. There is a Hawk suited to your needs from the 12" to the 26" with financing available. Try it in your shop for 30 days without risk and see how enjoyable and profitable scroll sawing can be for you.

SEND TODAY FOR YOUR FREE INFORMATION KIT



1801 VINE ST., P.O. BOX 369
HARRISONVILLE, MO 64701
1-800-535-8665

YES, TELL ME MORE ABOUT THE RBI HAWK LINE OF PRECISION SCROLL SAWS PLUS THE 30 DAY MONEY BACK GUARANTEE

NAME _____

STREET _____

CITY _____

STATE _____ ZIP _____

© 1986 RBI, INC. (PLEASE PRINT) CODE W12

BAND SAW BLADE SPECIALISTS

SPECIAL OFFER Buy Six Blades, Get One Free.

Band saw blades cut and welded to your exact specifications

WIDTH	TEETH	PRICE/INCH
1/8" thru 3/4"	3 thru 32	\$.04

Price=inch length x price per inch+1.75 weld charge
NO MINIMUM ORDER

Speedy Delivery
Add \$2.50 for shipping & handling
S.C. residents add 5% sales tax
Send payment with order—write or call

ROBERTS HARDWARE
P.O. Box 1276 • Taylors, SC 29687
803/879-2470

SHAKER PEGS CANDLE CUPS MUG PEGS

\$17.95 per 100, prepaid.
Wide selection of other wood products.

Catalog \$2.00 or free with order.

Benny's Woodworks

P.O. Box 656, Dept. WD3
Antioch, TN 37013
(615) 331-8384

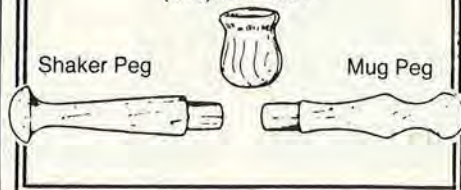

WOODWORKERS! Sand like professionals, quickly and beautifully



◆ B-12 Brush Head sands mouldings and intricate carvings without losing detail or shape of the part.



Model #DD-63
Gives quick and excellent results on contoured-shaped parts.

Everything we sell is industrial quality. Buy the complete unit or just the Brush Head and/or Pneumatic Drum and build your own.

Professional results in no time at all.
Write or call for the dealer nearest you.

Sand-Rite 321 North Justine St.
Chicago, IL 60607
MANUFACTURING CO. 312-997-2200

SCROLL SAW LETTERS EASILY...



...with **Lettering Layout Guides!**

- Name Plates
- Signs
- Gifts and more

Our unique Lettering Guides are available in many styles and sizes to suit your needs. Upper and Lower Case Script and Block Styles...and numbers too. Send \$1.00 for brochure and prices to:

SEYCO SALES

2107 So. Garland Ave.
Box 472749
Garland, Texas 75047

Statement of Ownership, Management and Circulation (Required by 39 U.S.C. 3685)

- 1A. Title of Publication: Better Homes and Gardens Wood.
- 1B. Publication No. 724890.
2. Date of Filing: September 23, 1986.
3. Frequency of Issue: Bimonthly.
- 3A. No. of Issues Published Annually: 6.
- 3B. Annual Subscription Price: \$18.00.
4. Complete Mailing Address of Known Office of Publication: 1716 Locust Street, Des Moines, Polk, IA 50336.
5. Complete Mailing Address of the Headquarters of General Business Offices of the Publisher: 1716 Locust Street, Des Moines, IA 50336.
6. Full Names and Complete Mailing Address of Publisher, Editor and Managing Editor: Publisher: Jerry Kaplan, 750 Third Avenue, New York, NY 10017; Editor: Larry Clayton, 1912 Grand Avenue, Des Moines, IA 50312; Managing Editor: Charles E. Sommers, 1912 Grand Avenue, Des Moines, IA 50312.
7. Owner: Meredith Corporation, 1716 Locust Street, Des Moines, IA 50336. The Names and Addresses of Stockholders Owning or Holding 1 Percent or More of the Total Amount of Stock: Cede & Company, Box 20, Bowling Green Station, New York, NY 10004; Kray & Company, One Financial Plaza, 440 South LaSalle Street, Chicago, IL 60605; Kray & Company, P.O. Box 10645, Newark, NJ 07101; Pearce & Pettit, c/o Wilmington Trust Company, P.O. Box 9746, Church Street Station, New York, NY 10249; Prop & Company, c/o Norwest Bank Des Moines, N.A., 666 Walnut Street, P.O. Box 837, Des Moines, IA 50304; The E. T. Meredith and Bohlen families and family foundations own directly or beneficially, through some of the nominees listed above, approximately 31% of the issued and outstanding stock of the corporation. Each nominee holds stock for one or more stockholders.
8. Known Bondholders, Mortgagees, and Other Security Holders Owning or Holding 1 Percent or More of Total Amount of Bonds, Mortgages, or Other Securities: None.

9. Item 9 of PS Form 3526 not applicable.

10. Extent and Nature of Circulation:

	Average No. Copies Each Issue During Preceding 12 Months	Actual No. Copies of Single Issue Published Nearest to Filing Date
A. Total No. Copies (Net press run)	543,162	572,141
B. Paid and/or Requested Circulation		
1. Sales Through Dealers and Carriers, Street Vendors and Counter Sales	75,667	90,000
2. Mail Subscriptions (Paid and/or requested)	315,279	308,980
C. Total Paid and/or Requested Circulation (Sum of 10B1 and 10B2)	390,946	398,980
D. Free Distribution by Mail, Carrier, or Other Means, Samples, Complimentary, and Other Free Copies	19,405	13,020
E. Total Distribution (Sum of C and D)	410,351	412,000
F. Copies Not Distributed		
1. Office Use, Left Over, Unaccounted, Spoiled After Printing	144	141
2. Return From News Agents	132,667	160,000
G. Total (Sum of E, F1 and 2—should equal net press run shown in A)	543,162	572,141

11. I certify that the statements made by me above are correct and complete. (Signed) Jerry Kaplan, Publisher

SUBSCRIBERS PLEASE NOTE!

WOOD magazine subscribers frequently express interest in products and services that are supplied by our company, Meredith Corporation, and by other reputable firms.

Accordingly, we sometimes send our subscribers offers for books, other magazines or home-related products and services of potential interest. We also make subscriber names and addresses available to other firms who are able to supply appropriate products and services. We screen all such offers and take great care to see that information about these products and services is sent only to subscribers who, according to our records, are most likely to be interested.

While we believe the distribution of this information will be beneficial to our subscribers, we firmly respect the wish of any subscriber who does not want to receive it. Should you wish to restrict this, simply send your request to WOOD magazine, P.O. Box 10263, Des Moines, IA 50336, enclosing a current address mailing label. Please be specific as to whether you still wish to receive Meredith Corporation offers or whether you want to stop all offers from any company, including Meredith. We will gladly honor your request.

Sleeveless DRUM SANDER

NO PRE-MADE SLEEVES TO BUY

ECONOMICAL — Simply cut sandpaper from standard size sheets
UNIQUE — Twist of key tightens sandpaper to drum.
SPONGE RUBBER backing insures long wear of sandpaper



1" x 3" long	\$13.50
2" x 3" long	\$15.50
2 1/2" x 3" long	\$16.00
3" x 3" long	\$17.50
1" and 2 1/2" Above \$27.00	Above 4 Drums \$55.00
3/8" x 3" long	\$14.50
2 1/2" x 4 1/2" long	\$21.00
3" x 4 1/2" long	\$22.50
2 1/2" x 6" long	\$25.50
3" x 6" long	\$27.50

Add \$2.50 Per Order For Shipping

AVAILABLE WITH:

- 1/2" Bore with 1/2" or 3/4" shaft
- 1/2-20 RH Thread except 3/4" x 3"
- 5/8" Bore except 3/4" x 3" and 2" x 3"

USE ON:
 Drill Press
 Small Motor
 Lathe, Combo-Tools,
 Radial Saw, 1/4" Drill



Send Check or Money Order to:

SINGLEY SPECIALTY CO. INC.

P.O. BOX 50878, GREENSBORO, N.C. 27403
 CALL: (919) 852-8581

For information about placing an advertisement in *Better Homes and Gardens*® **WOOD** write:

Mark Hart
WOOD Magazine
 750 Third Avenue
 New York, NY 10017

Or call collect:
 212-551-7130

FROM THE CENTRAL ALLEGHENY MOUNTAINS...



Wood sized to match your project, at prices sized to match your pocket.

Hardwoods and Softwoods, Kiln dried, Clear, and finished glass smooth on two sides. Wood pieces sized to your order. Thickness: from 1/8" to 4", Widths from 2" to 12" (in 1/2" increments). Lengths from 6" to 10 feet (in 6" increments). Smaller pieces are less costly per square foot. To find out why, and receive our price list send \$1.00 (deducted from first order).

HIGHLAND WOOD MILL

Dept. 1286 Headwaters, Virginia 24442.

Have a problem with your subscription?

We want to solve it to your complete satisfaction, and we want to do it fast. Please write to: Robert Austin, *Better Homes and Gardens*® **WOOD**, P.O. Box 10628, Des Moines, Iowa 50336.

You can help us by attaching your magazine label here, or copy your name and address as it appears on your label. Send this along with your correspondence.

Name _____
 Address _____ Apt. # _____
 City _____ State _____ Zip _____

Moving? Simply attach the mailing label from this magazine and write in your new address below. (Please allow 4-8 weeks.)

Your New Address Goes Here

Name _____
 Address _____ Apt. # _____
 City _____
 State _____ Zip _____

Subscription Rate:

6 issues — 1 year — \$18. Add \$6 for Canadian or foreign postage.

Renewal New Order

For Fast Service...

...it is better to write us concerning your problem and include the magazine label. Also, address changes are handled more efficiently by mail. However, should you need to reach us quickly the following toll-free number is available:

800-247-2504

Better Homes and Gardens®
WOOD

P.O. Box 10628 • Des Moines, Iowa 50336

Model 9900B
 3" x 21" Belt Sander
 w/dust bag

Special Price **\$128**



Model 2708W 8 1/4" Table Saw
 with Carbide Blade
 powerful 12 AMP
 Makita motor and
 4500 RPM

\$217



Makita

1-800-362-7227;
 after dial tone, dial 740
 • FREE FREIGHT •



Model 9401
 4" x 24" Belt Sander
 Now Only **\$149**

WORKBENCH TOOL CO.

2833 Perry St., Madison, WI 53713

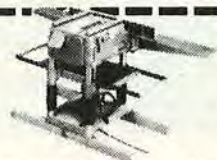

Model 2030N 12 1/2" Planer-Jointer
 with Electric Brake

SUGGESTED LIST PRICE \$2160

Special Price **\$1395**

F.O.B. Wisconsin



Model 6012HDW Cordless Driver
 Drill Kit, 2-Speed Reversible

SUGGESTED LIST PRICE \$178

Special Price **\$95**

101 PATTERNS

This wonderful packet contains 101 FULL SIZE PATTERNS of Gifts, Novelties, Lawn Figures, Bird Houses, Shelves, Action Windmills, Alphabets, and many more things. Just trace and saw out. Plus "Make Money Jig Sawing", Only \$7.00 Prepaid 1st Class for this big packet.

MASTERCRAFT PLANS WEST, DEPT. 15H
 PO Box 625, Redmond, WA 98073



90 PATTERNS

LAWN ORNAMENTS • NOVELTIES

FULL SIZE patterns up to 20" high of Dutch boy and Girl, Dwarf, Penguin, Fishing Boy, Animals, Birds, Novelties and many other popular items. Easy to make and sell. Just trace, cut out and paint. Send \$7 today for the LAWN ORNAMENT PACKET containing all 90 patterns. Prepaid, 1st Class.

MASTERCRAFT PLANS WEST, Dept. 12H
 PO Box 625, Redmond, WA 98073



FREE Tool Catalog

Quality Products For Woodworkers

Send today for your FREE copy of our new colorful catalog. It's fully illustrated with the finest quality tools, supplies, books, components, hardware, and much more. Satisfaction Guaranteed.

Write today for your FREE catalog.



WOODCRAFT SUPPLY CORP.
 Dept. WBH17
 41 Atlantic Avenue, Box 4000
 Woburn, Massachusetts 01888

DIVIDING A BOARD INTO EQUAL PARTS THE EASY WAY

Whether you're planning to rip a board into a number of equal strips or laying out divisions in a project drawing, here's a quick alternative to time-consuming calculations and measurements.

Imagine you have a $4\frac{3}{4}$ "-wide board you want to make into 11 equal parts. Instead of relying on long division, follow this method (illustrated *right*).

- 1 Lay a ruler across the board width at a diagonal to form AB.
- 2 Keeping one end of the ruler in place at A, adjust the other end slightly up or down until the ruler

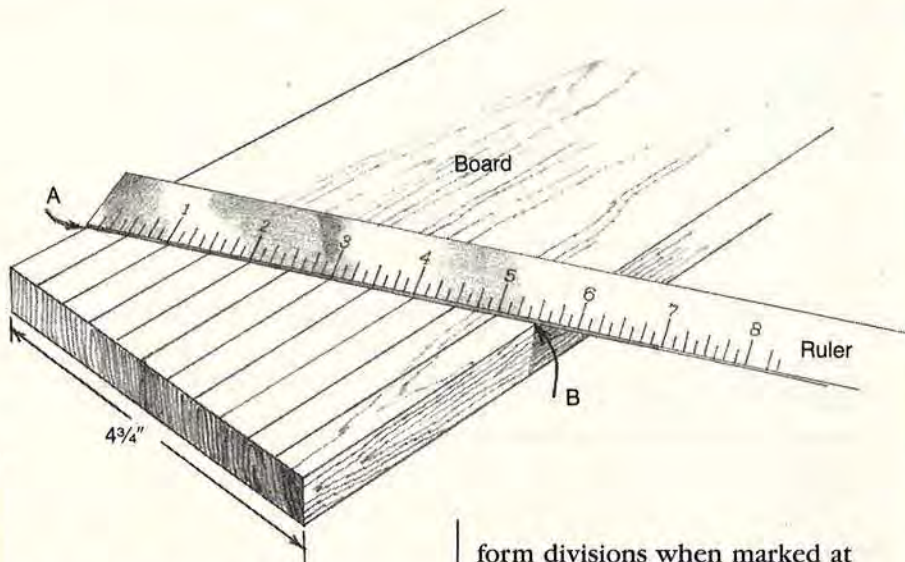

at B, lines up with a number that can easily be divided by the number of parts you need. In this case, the $5\frac{1}{2}$ " mark lined up at the right edge of the board provides 11 uni-

form divisions when marked at every $\frac{1}{2}$ " increment.

- 3 Place a dot at each $\frac{1}{2}$ " division.
- 4 Use a square and mark the division lines perpendicular to the end of the board.

Illustration: Jim Stevenson

Introducing...the "LIBERTY 18" 2-Speed-18-Inch Precision Scroll Saw!

This new scroll saw gives you features you won't find on any other... even the most expensive imported models.

- **New Table Support System**—doesn't get in the way while changing blades... table tilts 45 degrees both right and left!

30-DAY FREE TRIAL!



- **Two-Speed 1/4 HP Motor**—twice the HP of any comparable saw.
- **Lexan Laminated Cast Worktable**—Space age material is friction-less, yet tough.

Use this high precision tool to make toys, name bars, jewelry, Christmas ornaments, tole painting figures, and hundreds of other valuable... and profitable... items.

Call Toll-Free 1-800-538-4200 Ext. 2516
Woodmaster Tools, Inc. 2908 Oak
Dept. CW16 Kansas City, MO 64108

Woodmaster Tools—Dept. CW16
2908 Oak—Kansas City, MO 64108

YES! Please rush me your FREE Information Kit on the new LIBERTY 18 Precision Scroll Saw, including details on your 30 DAY FREE TRIAL GUARANTEE!

Name _____
Address _____
City _____ State _____ ZIP _____

MADE IN U.S.A.

MAKITA • PORTER CABLE • DELTA • BOSCH • LION • HILLER HARDWARE CO. • FOOTPRINT • MILWAUKEE • FORSTNER • JORGENSEN • 3M • W.L. FULLER

ASSURES YOUR SATISFACTION ON ANY ITEM PURCHASED FROM US! WE CAN SHIP YOUR BANK CARD ORDER TODAY

freud INDUSTRIAL SAW BLADES 10" CARBIDE TIPPED BLADES

Blade	Description	Teeth	List Price	Hiller's Price
LU73	Cut-Off	60	79.65	37.95
LU82	General Purpose	60	86.50	39.95
LU84	Combination	50	74.51	32.95
LU85	Combination	80	110.88	56.95
LM72	RIP	24	64.85	34.95

5/8" BORE STANDARD, ADD \$8.00 FOR ANY OTHER BORE

- WE HONOR ALL FREUD NATIONALLY ADVERTISED SPECIALS
- CALL OR WRITE TODAY FOR CURRENT PRICES ON OTHER TOOLS/ACCESSORIES
- PRICES QUOTED, DELIVERED PREPAID ON \$75 MINIMUM ORDER
- VISA, MASTERCARD ACCEPTED



YOUR WOODWORKING SPECIALIST IN THE SOUTHEAST

MAKITA • PORTER CABLE • DELTA • BOSCH • LION • HILLER HARDWARE CO. • FOOTPRINT • MILWAUKEE • FORSTNER • JORGENSEN • 3M • W.L. FULLER • HEGNER • STANLEY • LEIGH • HENCKELS • MERIT

CATALOG SHOP



1. Horton Brasses' catalog shows over 500 items of authentic reproduction hardware from the 1700s and on into this century. These are superior reproductions of Chippendale, Hepplewhite, Queen Anne, Sheraton, Victorian and early 1900s brass furniture hardware. Catalog \$2.00.



2. Toy Designs' catalog of wooden toy patterns, hardwood turnings, complete kits; also patterns plus turnings kits and woodworking books. Seven full-sized patterns \$5 each; four or more for only \$4 each. Package of eight spoked wheels \$5.95. Catalog free with order. Catalog alone \$1.50.

W.S. JENKS & Son 
WOODWORKING TOOLS,
MACHINERY & SUPPLIES

3. W.S. Jenks & Son's new 150-page sourcebook is packed with a full range of tools for the serious woodworker, from hand tools and portable power tools to woodworking machinery. Includes many imported and hard-to-find tools from the best manufacturers at the most competitive prices. \$2.00 (refundable with first order).

Woodmaster

4. The two-speed Liberty 18 Scroll Saw from Woodmaster outperforms even the most expensive imported saws! Anti-friction worktable, 1/4 HP two-speed motor, integral stand, dust blower and many more standard features make this your best scroll saw buy! Send for free information kit today!



5. Cherry Tree Toys' color catalog is chock-full of plans, parts, kits and supplies for whirligigs, toys, doll houses, swing sets, classic autos, furniture and crafts. Also parts (toys, craft, game and furniture) in maple, oak, walnut and cherry. Bulk prices available. Catalog subscription \$1.00.



6. If you are making toys and other items for craft shows and flea markets, don't overlook our great selection of patterns for rocking horses, pull toys, cars, clocks and furniture. Specialty supplies also available. Armor Products catalog \$1.00.



7. Quartz clock movements. Our 60-page, full-color catalog features a large selection of movements and a full line of clock-making supplies and accessories. Thousands of ultra-thin pendulum and chime movements always in stock. Most orders shipped within 48 hours. Catalog Free.

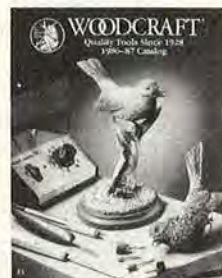

8. This woodworkers catalog is more than a catalog—it's one of the best sources for quality woodworking tools. You'll find everything from bit braces to wood borers, from saws to sharpening stones. Every product is sold satisfaction guaranteed. Free. Woodcraft Supply Corp.



9. Cabinetmakers' tools and supplies. New 224-page catalog of fine hand and power tools for cabinet makers or serious woodworkers. Also featured are three sections on hardware, supplies and cutting tools. This catalog takes the mystery out of using European hardware. A must reference for the woodworker. \$3.00.



10. Moisture-related problems, such as shrinking, warping and cracking, can ruin the most beautiful wooden pieces ever built. Avoid wood moisture problems by checking the wood with a moisture meter! The pocket-size Mini-Ligno moisture meter is for the serious hobbyist and professional woodworker. Free brochure.

XYLOPHILE'S

11. 24-page color catalog from the Xylophile's Company is full of tool bargains from Ryobi, Powermatic, Hitachi, Makita, Minimax, Freud and many others. Everything for your shop. Professional quality at down-to-earth prices plus the fast, courteous service you demand. \$1.00.



12. R.A. Ness & Co., The Woodworkers Emporium, offers a two-year, eight-issue catalog subscription. Thousands of industrial quality items—machinery, hand tools, portable electric tools and supplies featured at super sale prices. Fee refundable with purchase. \$4.00.



Furniture Designs, Inc.

13. Wonderland for woodworkers! Illustrations and descriptions of over 180 full-size plans of fine, museum-quality furniture. Includes cradles, roll-top desk, tables, chairs, buffets, chests, gun cabinets, poker table, children's furniture, rocking horse, spinning wheels and more. Catalog \$2.00-refundable with first plan order.



17. Constantine's 175th Anniversary Catalog for woodworkers offers 116 pages of 150 kinds of veneers, 250 sizes of cabinet grade hardwoods, specialty woodworking tools and accessories. Hard-to-find hardware, inlays, mouldings, cane, wood finishes, plans and books. The best source for woodworkers and restorers. Satisfaction guaranteed. \$1.00.



21. DML's line of professional, industrial-quality saws is detailed in a 12-page catalog. Covered are tungsten-carbide-tipped rip, cutoff, trim, plywood, plastic, panel, miter, planer, non-ferrous and general-purpose combination saws, industrial dado sets, miter-box saws and DML's new Radi-All combination-grind saw. Part numbers, diameters, bores, tooth numbers and plate/kerf measurements are included. \$1.00.



14. Tool catalog. Available from Elektra Beckum U.S.A. Corp. are advanced technology woodworking stationary power machines with the unique Unimex Motor interchangeable concept. For complete information on Jointer/Planer, Bandsaw, Dust Extractor, Spindle/Moulder, Lathe and Combi Saw send for our catalog. \$1.00.



18. Grizzly Imports, Inc. is a unique mail-order company because it specializes in selling heavy-duty woodworking machinery and accessories that are of high quality. The low prices are surprising and often enable a craftsman to equip a complete shop for a fraction of the cost of locally made tools. Catalog \$1.00.



22. 212-page 1987 Garrett Wade catalog features more than 2,500 items accompanied by valuable reference material on proper tool usage. This premium line of products includes hand tools, finishing supplies, clamps, shop accessories, woodworking books and Japanese tools. Power tools include INCA Swiss woodworking machinery and German lathes. \$4.00.



15. Workshop Blueprint's project plans for woodworkers. Professionally designed projects include furniture, playthings and accessories, storage sheds and gazebos. Plans use readily available materials and standard sizes of lumber. Instructions are clear and concise. Send \$2.00 for our catalog (refundable with order) and get started!



19. Discover the world's oldest hobby! Build fine quality wooden ship models from easy-to-assemble kits. Described are true-to-scale replicas with gleaming brass fittings, exotic woods and delicate rigging, which are lifelike in every detail. A 64-page color catalog from Model Expo. \$3.00 (refunded with first order).



23. Kuster Woodworkers' catalog features affordable, quality products: UltraSand™ Heavy Duty Thickness Sanders; DynaSand™ Thickness Sander Kits; SandAid™ Abrasive Belt & Sleeve Press for making your own sander belts and sleeves; quality hand tools; abrasives and supplies. Several exciting new products will debut in 1987, so get on our mailing list today.



16. Executive wood toys! If you want more in the line of wood toys, let Toys and Joys offer you a line of detailed patterns for classic cars, trucks, trains, etc. We also carry a complete line of wood toy parts. Ask about our deluxe spoke wheels. Catalog \$1.00.



20. Woodworker's supplies catalog! Hundreds of handtools, patterns, veneers, hardwoods, turning and carving stock, wood parts, books, cane, hardwood dowels, supplies, edgings, custom veneer faces. Many major brands. Save 20% on Freud! 56-piece woodworkers' kit only 17¢! Hurry! Send \$1.00 for catalog today!



24. Classic Hardware Catalog is a design guide for craftsmen. Forty full-color pages of the finest imported and domestic brass furniture hardware. Wide selection of standard and specialty hinges including piano, butler's tray, rule joint, rat-tail and European cabinet hinges. Every item shown full size enabling you to see how your project will look when finished. \$1.00.



25. Full-color 64-page catalog carries the finest tools for the serious woodworker, including Western and Japanese hand tools, finishing supplies and portable power tools by AEG and Ryobi. Also, unique items such as workbenches made of African teak, small-scale tools for the miniaturist, handmade turn-of-the-century tools and inflatable drum sanders for portable power tools. Rent a how-to video for \$10 a month. Fine Tool Shops Catalog Free.



29. Freud, manufacturer of the finest in hand tools and carbide tools, makes these two catalogs available to you. They feature a large selection of quality chisels, carving tools, turning tools, planes, as well as carbide saw blades, router bits and shaper heads. Send for your catalogs today. \$5.00.



33. Miniature Antique Transport Plan Catalog. Criss-Cross Creations' newest catalog features vehicle plans designed for the serious scale woodworker. 1849 Concord Coach can be built in 1" scale using our full-size cutting patterns, photos, exploded assembly and instructions. Many other vehicles available. Catalog brochure \$1.00.



26. Meisel Hardware Specialties' all new 48-page catalog is the source for hard-to-find woodworkers' specialty hardware and project plans. Included are new toy truck plans, doll furniture plans and new country projects. Toy makers' parts include regular wood wheels, wood truck tires with treads, wood wheels with rubber tires and many decals for toy trucks and airplanes. Other items include stenciling supplies, jewelry box hardware, Shaker pegs, antique toy restoration parts and plans for homemade power disc sanders. Many prices are discounted 40%. \$1.00.

ZAC

30. Square it™ is a newly patented electronic precision square with a guaranteed accuracy of $\frac{1}{10,000}$ of an inch; preset at exactly 90° and 45°. Introductory special of Square it™ complete with 18-page manual and warranty. The 37-page DOOR SHOP™ MANUAL covers the complete process of door building; the most comprehensive manual out today. Get the Square it and Door Shop Manuals both for \$6.50.

CASCADE TOOL CO.
Box 848, Mercot Island, WA 98040

34. Over 200 router bits and shape cutters displayed in catalog featuring six-piece cabinet sets, three-piece ½ in. shank router bit panel raising system and three-wing industrial shaper cutters. Shaper cutters available in ½ in. through 1-¼ in. bore with bushings. Router bits offered in ¼ in. and ½ in. shank. Catalog \$1.00.



27. Patterns by Design Group. Hundreds of interesting, useful and fun items to create for personal use or profitable sale. Our 1987 catalog contains plans for toys, games, plaques, puzzles, bird houses, planters, furniture and much, much more! All Design Group patterns are professional, "same-size" blueprints. No enlarging or reducing is necessary. Simply trace outline of item onto wood and create! Full money-back guarantee. Wholesale and bulk prices available on request. Fully illustrated catalog \$1.00.

WARREN TOOL CO., INC.

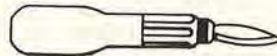

31. Warren Tool Company's Wood-carver's Catalog features the finest quality whittling and carving hand and power tools, books, sharpening stones, wood and supplies. Warren Tool has become a common name in the wood carving world because we take pride in selling only the finest professional tools. Remember our motto: "Warren Tools give you the edge." Send \$1.60 for catalog #5.



35. Wyndham Woods is a supplier of the highest quality domestic and exotic lumber and veneer. Our specialties are: fitch-cut lumber (wide boards cut from the same tree), unusually figured and colored veneers, thick domestic veneers and thin lumber. \$1.00.



28. Over 500 woodworking designs! Create gifts, toys, whirligigs, folk art, bird houses and feeders, magazine racks, shelves, children's items, kitchen and household accessories plus much more! Simple enough for the beginner, fun and profitable for the pro. Brochure plus sample pattern only \$2.00.

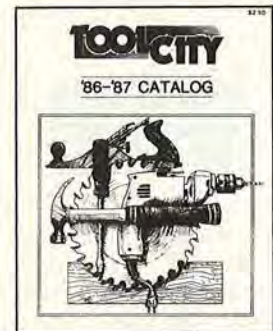

32. Tool City catalog is 408 pages; the most complete mail order tool catalog. Priced to save you money in all categories. All types of power and hand tools at discount prices. \$2.50.



36. Quality handcrafted clocks. Made by grandfathers in solid walnut, cherry or oak. Kits, "from scratch plans" or completely finished. Grandfather, wall or mantel clocks. Hand-painted moon wheels on fine West German movements. Catalog \$2.00.

GILLIOM MFG.

37. Power tools for woodworkers. Plans and kits of metal parts to build your own band saw, sander, wood shaper, circular saw, lathe/drill press. Use our easy-to-follow plans or design your own tool with our parts and accessories. Brochure and complete information \$1.00. Kits priced from \$34.99 to \$189.99.



41. "Easy Wood Finishing." Learn how to finish wood easily and beautifully with Watco, The Original Danish Oil Finish. Get a natural, hand-rubbed look in one step...with one product. Full-color brochure includes usage, tips, troubleshooting and more. \$1.00.



45. Advance Machinery Imports, Ltd. Complete data on AMI's primary products: Hegner precision saws and Hegner wood lathes and duplicators. Reference data, photos, specifications, prices and ordering information. Also, complete details on AMI premium scroll saw blades with coupon for FREE saw blades worth \$4.00. Send \$2.00.



38. Antique restorers, woodworkers, collectors and hobbyists! This 160-page wholesale catalog is loaded with unique, hard-to-find items! Includes hundreds of essential antique restoration parts, brass reproduction hardware, oil lamps and accessories, wood parts, caning, basketry, upholstery and art supplies, wood refinishing products, tools, books, etc. \$1.00.

MLCS

42. If you own a router, send for our free information kit on router bits. Large discounts. High quality router bits and the Merle Adjustable Corner Clamp are our only business. All bits are two flute with thick tungsten carbide tips and have 1/2" ball bearing pilots. Prices up to 50%-70% lower than elsewhere. Value, quality and prompt service guaranteed! Free.

HAMMERMARK ASSOCIATES

46. Hammermark Associates' 16-page furniture plan catalog features 24 furniture plans. We currently offer two different types of plans. Our WEEKEND WORKSHOP SERIES offers quick projects that can be completed in a weekend or two. Our CLASSIC SERIES consists of projects that take a little longer to produce. These antique reproductions are likely to become family heirlooms. Catalog \$1.00 (deducted from first order).



39. The 1987 Hiller Hardware Catalog is a comprehensive collection of tools and accessories for you. Select from the best quality tools in the business at a price only a volume supplier can provide. Power tools, hand tools, cutters, blades and accessories. 24 pages, over 240 tools! \$1.00.



43. Woodworks offers low prices and fast service on hundreds of beautifully turned birch, walnut, oak and cherry wood parts. Our 36-page catalog also includes hard-to-find hardware and tools. Send \$1.00 for catalog, bonus coupon and our special "get acquainted" offer.



47. Buy your sanding belts direct from the manufacturer and save! Yes, Industrial Abrasives is the company that gives you six free belts with every dozen ordered. *But*, sanding belts are not the only product we have to offer. In our catalog you will find many sanding related items not readily available in your hardware store. \$1.00 (refundable with order).

VIKING SOLID WOOD CLOCKS

*Grandfather *Wall *Mantel

40. Solid wood clock kits. Full-color catalog of beautiful, easy-to-make clocks. Grandfather, mantel and wall clocks. All solid wood with solid brass pre-assembled movements. All parts hand-cut for perfect assembly even by beginners. Viking Clock Co. Catalog 50¢.



44. St. Croix Kits' 32-page Music Maker's Catalog contains various kits in guitar, banjo, mandolin, dulcimer and harpsichord building. Each kit is rated by skill and patience level. The projects have all been selected by Jerry Brown and all kits are completely guaranteed. Catalog \$1.00.



48. The new Acme Electric catalog of Delta Woodworking tools is now available and full of specials including items from our all new lumber company. Most orders shipped same day, freight included. Factory-authorized service. \$1.00.

NOW! Woodmaster lets you **PLANE, MOLD & SAND**

with the Precision Control of

Infinitely Variable Power-Feed!



**FREE
30-DAY
TRIAL!**



MADE IN AMERICA

Find out how you can try out this machine in your shop for a full 30 days... Call or write for your FREE Information Kit today!

**FREE
INFORMATION
KIT**



Woodmaster's Quick-Change Molding Head lets you create custom moldings from any stock. Choose from over 250 standard trim and picture frame patterns... or design your own!

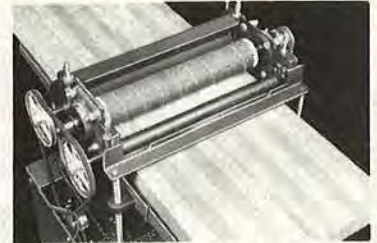

Power-fed sanding speeds production and improves the quality of your work. No more waves or cross-grain scratches. Separate Sanding head installs in just minutes.



YES! Please rush me your FREE Information Kit plus details on your 30-DAY FREE TRIAL GUARANTEE!

WOODMASTER TOOLS, INC., DEPT. PW16
2908 Oak Street • KANSAS CITY, MO 64108
Or Phone: 1-800-538-4200 Ext. 2316

NAME _____
ADDRESS _____
CITY _____
STATE _____ ZIP _____



49. Frog's new catalog of quality woodworking hand tools. Over 400 books on woodworking. Myford lathes and turning tools. Free.

MAKITA

50. Workbench Tool Company offers the rugged, precision-built Makita Tool line at special discount prices. Catalog and current price list \$.50.

rb industries, inc.

51. RBIndustries features a full line of Woodplaners and Hawk Precision Scroll Saws proudly made in America by American craftsmen. Patented quick-change planer allows faster and easier set-up for sanding, molding or planing at a surprisingly low price. Catalog \$1.00.

The Discerning Craftsman Catalog Shop ORDER FORM

Circle the catalogs you want. Fill out the coupon and include your check made out to Better Homes and Gardens® for the cost of the catalogs you ordered plus the \$2 handling fee. Please allow 4-6 weeks for delivery.

Circle the catalogs you want to receive:

- | | | | | | | | | | |
|-----------|-----------|------------|------------|------------|------------|------------|------------|------------|------------|
| 1. \$2.00 | 6. \$1.00 | 11. \$1.00 | 16. \$1.00 | 21. \$1.00 | 26. \$1.00 | 31. \$.60 | 36. \$2.00 | 41. \$1.00 | 46. \$1.00 |
| 2. \$1.50 | 7. Free | 12. \$4.00 | 17. \$1.00 | 22. \$4.00 | 27. \$1.00 | 32. \$2.50 | 37. \$1.00 | 42. Free | 47. \$1.00 |
| 3. \$2.00 | 8. Free | 13. \$2.00 | 18. \$1.00 | 23. Free | 28. \$2.00 | 33. \$1.00 | 38. \$1.00 | 43. \$1.00 | 48. \$1.00 |
| 4. Free | 9. \$3.00 | 14. \$1.00 | 19. \$3.00 | 24. \$1.00 | 29. \$5.00 | 34. \$1.00 | 39. \$1.00 | 44. \$1.00 | 49. Free |
| 5. \$1.00 | 10. Free | 15. \$2.00 | 20. \$1.00 | 25. Free | 30. \$6.50 | 35. \$1.00 | 40. \$.50 | 45. \$2.00 | 50. \$.50 |
| | | | | | | | | | 51. \$1.00 |

Send to: Better Homes and Gardens®, WOOD, Jan./Feb. 1987, P.O. Box 2051, Clinton, Iowa 52732.

I am enclosing: \$ _____ for catalogs
\$ 2.00 for handling
\$ _____ total payment

Name _____

Address _____

City _____ State _____ Zip _____

OTHER WAYS TO SELL

YOUR WORK: 3 OPTIONS TO CRAFT FAIRS

Crafts fairs rate as a favorite way for many woodworkers to sell what they make (see article on page 62). But what if you're not cut out to man a booth eight hours a day talking to complete strangers? If you would rather trade sales pitches for shop time, you have other avenues to market your work.

ONE-ON-ONE WITH COMMISSION SALES

Commission, or special-order, may be the most convenient way to get started selling your work. Essentially, you build a project or make an item to specifications requested by the customer, with the price agreed on at the time you take the order.

By selling through commission, you stay at home in your shop, have minimal selling expenses, don't have to invest in lots of lumber, or stock a large inventory of finished pieces.

However, commission sales classify as retail selling, so you'll have to have a state retail tax number (see page 87) and collect taxes for the state.

Usually applicable to furniture and cabinets, commission selling requires that you have an agreement with the customer as to what the finished project will look like. You can make that clear with sketches or photos of similar pieces, and with written descriptions and specifications. You should know fairly accurately how much time you'll put into the project to arrive at a price.

Request down payments to cover materials and some of your time. It commits your client to purchase the completed piece.

WHOLESALE FOCUSES ON PRODUCTION

When you do most of the work and the retailer marks up your product 100 percent (typically), it seems like you don't get much of the gravy. But, when you add up the time you'd have to spend, and the money, to retail your offerings in quantity, wholesale selling becomes more sensible.

Wholesaling also enables you to move lots of your handmade merchandise to a variety of outlets — retail stores, gift shops, and gift catalog companies — to name a few. And after you've delivered the order and have been paid, your worries are over. But to wholesale successfully, you'll have to brush up on your business savvy regarding purchase orders, credit, returns, fulfillment, and shipping. Products that you can make quickly in quantity probably adapt best to wholesale.

DISCOUNT TOOLS

WE OFFER DISCOUNTS UP TO 50% AND MORE ON AMERICA'S BEST NAME BRAND POWER TOOLS BE WISE — COMPARE

PORTER-CABLE

PROFESSIONAL POWER TOOLS

Our Price \$119



MOD#	DESCRIPTION	List	Sell
100	Router	147	94
126	Plane	265	169
310	Laminate Trimmer	160	129
312	Laminate Trimmer	205	134
330	Block Sander	90	54
351	3x24" Bit Sander	269	169
383	4x24" Bit Sander	294	183
503	3x24" Bit Sander	515	345
504	3x24" Bit Sander	500	335
505	Hyv Dry Finish Sander	160	99
513	Lock Monitor	975	679
518	3 Hg Elec. Router	550	335
536	1 1/2" Hg HD Router	300	195
530	Router 1 Hg	156	107
690	Router 1 1/2" HP	194	129
7511	3/8" VSR Drill	189	115
7514	1/2" VSR Drill	174	119
7548	VS Jig Saw	199	135
9827	2 hp Tiger Saw Kit	199	136
99281	Hinge Template	208	148

Makita Power Tools



Model 2401B \$189

1100	3 1/4" Planer	312	169
1900BW	3 1/4" Planer Kit	178	99
2401B	10" Mini Saw	329	189
2708	8 1/4" Table Saw	248	159
3601B	Router D Handle	198	118
3612B	3/4" Plunge Router	318	179
4300M	4 3/8" Trim Saw	168	99
5081DW	Cordless Circ. Saw	192	102
5402A	18" Beam Saw	518	299
6012Hdw	3/8" Cordl. Scndrll	188	94
6300LR	1/2" Ft. Angle Drill	258	159
6301LR	1/2" D-handle Drill	198	118
6510Lvr	3/8" VSR Drill	136	69
6600Dw	D-2500 rpm Srewdr	144	79
6800B	1/2" Impact Wrench	252	139
6906	3/4" Impact Wrench	528	299
8419B2V	3/4" Hw Drillcase	268	145
9020	1" Belt Sander	208	125
92079PB	2 Spd Polisher	218	123
9501BK	4" Mini Grinder	138	59
9620-2	Blade Sharpener	268	159
9924B	3x24" Bit Sander	208	124
B04510	Block Sander	86	45
DP4700	1/2" VSR Drill	172	91
HP1025	3/8" Hw Drill	88	69
HP1030V	3/8" Hw Drillcase	148	95
HP1300V	Vsr Spd Recipro Saw	198	114

MAKITA BATTERY PACK SPECIAL
9volt 30.00
7volt 29.00

Black and Decker Tools

1778	3/8" Drill D-1200	122	69
1840	Cordl. Dr. w/ Cutter	184	99
3091	2 1/4" Worm Dr. Saw	246	120
3103	2 Spd Cutsaw	161	89
4918-10	Plum Sander	88	39
5513-09	1/2" Elec. Imp. Wr	179	109

Bosch Power Tools

1272	3x24" Belt Sander	259	165
1581VS	Jig Saw Orb. Action	230	124
1601	1 1/2" Router	149	89
1604	1 3/4" Hp. Router	209	115
1821var	Cordless Drill 3/8"	189	99
90-300	3 1/4" HP Router	500	350
1842	Heat Gun	90	59
3230	Jig Saw	85	49

BOSCH. Top Handle, Orbital Action Jig Saw Model 1581VS

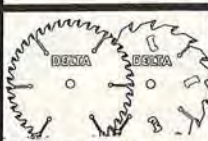

Delta Carbide Blades and Cutters

35-600	9"x80T TGSF	97.50	58
35-625	10"x80T TGSF	123.00	76
35-604	9"x80T ATB	88.00	49
35-623	10"x80T ATB	116.00	69
35-677	14"x108T ATB	158.85	89
35-647	12"x72T ATB	145.10	79
35-628	10"x80T ATB	83.85	49
35-660	8" Carb Dado Set	190.00	99
Selected DELTA Shaper Cutters up to 50% off Suggested List Price			
43-921	Cabinet set	340.70	165
43-922	Cabinet set	362.45	169

Milwaukee Tools

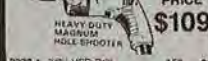

OUR PRICE \$109

9222-1	3/8" VSR Drill	169	88
9234-1	1/2" VSR Drill	173	108
0566-1	Drain Cleaner	271	175
10074-1	1/2" Drill HD	217	149
1256-1	1/2" Drill	517	148
1610-1	1/2" Spade Hndl Drill	208	122
1630-1	1/2" Compact Drill	217	148
1670-1	1/2" Hole Hwng	300	189
3002-1	Rt. Ang. Electrodial Drill	276	175
3107-1	Rt. Ang. Drill Kit	298	204
3309-1	Rt. Ang. Magnum Dr.	271	169
5347	1 1/2" Rotary Hwng	586	399
5399	1/2" Hammer Drill	284	179
5455	7/8" Polisher	199	136
6012	Orbital Sander	173	116
6095	9" Sander/Gr-der	227	104
6215	Chain Saw	209	143
6377	7 1/4" Worm Drive Saw	278	143
6511	2-800 Spsawll, case	197	116
6539	Cordless Screwdriver	94	69
6543-1	0-1000 rpm Screwdriver	217	149

Hitachi Power Tools

D10V	3/8" VSR Drill	139	69
D13	1/2" Spade Hndl Drill	198	99
DR10B	3/8" Cordl Scndrll	159	74
F20A	3 1/4" Planer	153	69
TR5	Laminate Trimmer	148	83
TR12	3/8" Router	321	169
CT5A	1 1/4" Circular Saw	119	65
WEVA	0-2500 Srewdriver	133	79
CR0V	Vsr Spd Recipro Saw	224	107



OUR PRICE \$74

Skill Tools

77	7 1/4" Worm Dr Saw	240	129
471	1/2" Impact Wrench	139	89
492	VS Jig Saw	89	49
500	Auto Scroll Jig Saw	99	49
515	Orbital Jig Saw	119	59
542	Spade Handle Drill	185	109
551	5 1/2" Circular Saw	99	72
597	3/8" VSR Drill	96	59
598	1/2" VSR Drill	103	69
984	Disc Sander	178	99
2016-2	3/8" cordl var Drill	199	95
1400	4x21 3/4" Belt Sndr	225	135



MOD #77 \$129

Porta-Plane®

MODEL 126 \$169



Thomas Portable Oil-less Compressor

\$299

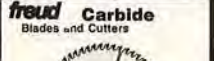

freud Carbide Blades and Cutters

LU72M010	10" x40T Gen Purp	34
LU73M010	10" x60T ATB	34
LU83M010	10" x80T TGSF	34
LU84M011	10" x50T Combo	34
LU85M010	10x80 T Fine Cutoff	79
LU73M012	12" x72T ATB	53
DC308	9" Dado Set	69

\$147



90-100	15pc Router Bit Set	126
94-100	Spd Router Bit Set	147
99-210	3hr Raised panel Router bits	50.00



99-260	Sile and Rail	75.31
FB-100	16 piece Forsiner bit set	139.80
EC-990	Complete Cabinet set	148.80
EC-091	Core & Bead set	148.60
EC-280	1/4 Stock Sile & Rail set	145.30
EC-900	Spd Shaper Cabinet set	244.30

Selected Blades — Cutters by Freud up to 50% off Suggested List Price

Ryobi Tools

\$159

AP10	Planer	899	345
E8000	0-4000rpm Drywall	129	79
E3810	0-2500 Drywall Dr.	129	79
R1UD0V	Vsr Spd Recipro Saw	199	99
S500A	Block Sander	59	29.95
SP180	Sander/Polisher	184	109
TR00	Laminate Trimmer	134	85
TS251U	10" Mini Saw	359	159
TS380	14" Mini Saw	629	319
W2005	16 1/4" Beam Saw	529	279

\$345



Bostitch Nail Guns

up to 50% off Suggested List Price

N18CT	Framing 55-10d	695	417
N405	same as above	695	417
N795	LI Framing	545	327
T36-50	1/2" crown stapler	470	282
T35-4	1/2" crown stapler	370	222
T36-16	35-80 T-Nailer	495	297
T35-40	Brad Nailer 1 1/4" x 34	470	292
T29-1	Brad Nailer 5/8" x 31	325	159
T31-1	same as above	169	118
T29-5	5/32" crown stapler	370	222

PREPAID FREIGHT TO 48 STATES ANY ITEM THIS PAGE

Senco Nailguns

LS II	5/8-1" Planer	290	246.50
SN I	Brad Nailer 1 1/4" x 34	283	249.00
SN II	1 1/4" Finish	302	249.00
SN III	1 1/2" x 1 1/2" Finish	476	385.00
SKS	1/4" Crown Stapler	279	237.15
SN IV	2 1/2" Framing Nail	578	491.30

ABBEY TOOLS

A DIVISION OF ABBEY MACHINERY
616 NORTH BROOKHURST STREET • ANAHEIM, CALIFORNIA 92801
ORDER BY PHONE — WE ACCEPT VISA, MASTER CARD, CHECK, MONEY ORDER
Toll Free 1-800-225-6321 Call 1-800-252-2221
Orange County (714) 772-7222
PRICES SUBJECT TO CHANGE WITHOUT NOTICE
Calif. Residents Add 6% Sales Tax

SHARE WORK AND PROFIT WITH CONSIGNMENT

Compared to wholesaling, with consignment you realize a higher portion of your product's final selling price — usually 60-80 percent, depending on the shop. But because the shop assumes the selling overhead, responsibility for moving your merchandise, and collection of any sales tax, you don't get paid until after your work has been sold. You trade delayed payment for their investment in the business.

Even the IRS considers the products you have out on consignment yours until they're sold. So, you do have some responsibilities. You must keep track of how much of your work is where. You're also expected to pick up old merchandise that didn't sell and deliver new. That's why it makes sense to consign your work only to shops within a reasonable travel distance.

Written agreements for consignment sales (the law in some states) protect you and your work from loss. They should also cover time intervals for payments to you for merchandise sold, and how often you have to replenish the store's stock. Some consignment outlets, especially galleries, may limit you as to where else you can sell your work and how much you can sell it for. These restrictions should always be made clear in the contract.

Consignment selling works for most handcrafted items, but it's extra-appealing if you make higher priced furniture, case goods, or unique, one-of-a-kind creations too fragile or expensive to ship very far.

BEFORE YOU SELL, SEE AN ACCOUNTANT

No matter how you sell, you're in business, and a different set of tax rules apply. Different ways of selling might even require different accounting methods. So, consult a professional tax accountant. 🍀



This VET Did It — and YOU Can Do It Too!

"War injuries left me badly handicapped, but now I'm a financial success as a Locksmith, thanks to your training. Besides, the work is fascinating. If I can do it anybody can." — Glen Johnson, Larned, Kan.

Make Up to \$26.00 an Hour — even while learning!

Train FAST at Home!

Be a LOCKSMITH!

If you enjoy fixing things, you're a "natural" to make hundreds of EXTRA DOLLARS a year in the fascinating business of Locksmithing. Rising crime has increased demand for service a thousandfold. **Yet there's only one Locksmith for every 17,000 people!**

COLLECT CASH PROFITS ALMOST AT ONCE!

You're "in business" ready to make \$10 to \$26.00 an hour a few days after you begin Foley-Belsaw's shortcut training. Easy illustrated lessons complete with ALL practice equipment **PLUS**

- ALL TOOLS YOURS TO KEEP
- KEY MACHINE YOURS TO KEEP
- EXPERT PERSONAL ASSISTANCE
- BUSINESS-BUILDING HELP

enable you to get your share of this always-profitable business. Hundreds we've trained are doing it. So can YOU.

MAIL COUPON to discover how Locksmithing can keep the extra money coming in during spare time — or in your own full-time business. Ideal for retirement — good jobs, too.

FOLEY-BELSAW INSTITUTE, 11061 Field Bldg.
Kansas City, Mo. 64111

N. Hunt, Wilmington, Del. — "I make \$50 a week extra."

R. Davis, St. Louis, Mo. — "I cleared \$110 last Saturday."

Ed Boyle, Pittsburgh, Pa. — "My business going at top speed. I'm moving to bigger quarters."



MAIL THIS COUPON • NO SALESMAN WILL CALL

FOLEY-BELSAW INSTITUTE, 11061 Field Bldg.
Kansas City, Mo. 64111



Rush **FREE** book, "Keys to your Future."

Name _____

Address _____

City _____ State _____ Zip _____

THIS DO-ALL PRO KEY MACHINE YOURS TO KEEP!

Can add \$50 to \$100 a week to your income... and doesn't cost you a penny extra!

FREE

FREE SANDING BELTS DIRECT FROM THE MANUFACTURER

GET SIX FREE BELTS FOR EACH DOZEN ORDERED. All belts are aluminum oxide first quality. Our electronic presses make smooth bump-free splices.

Check your size and how many dozen. We will ship assorted grits unless otherwise specified.

- 1" x 30" — \$13.70/doz.
- 1" x 42" — 13.75/doz.
- 1" x 44" — 13.80/doz.
- 3" x 18" — 14.75/doz.
- 3" x 21" — 15.25/doz.
- 3" x 23 3/4" — 15.70/doz.
- 3" x 24" — 15.75/doz.
- 3" x 27" — 16.25/doz.
- 4" x 21 3/4" — 17.75/doz.
- 4" x 24" — 18.25/doz.
- 4" x 36" — 21.95/doz.
- 6" x 48" — 27.95/1/2 doz. (3 FREE)

Other size belts on request.

9" x 11" Paper Sheets

A/O Cabinet Paper

- | | |
|--|-----------------------------------|
| 50/pk. | 100/pk. |
| 40-D <input type="checkbox"/> \$17/pk. | <input type="checkbox"/> \$31/pk. |
| 50-D <input type="checkbox"/> 16/pk. | <input type="checkbox"/> 28/pk. |
| 60-D <input type="checkbox"/> 15/pk. | <input type="checkbox"/> 26/pk. |
| 80-D <input type="checkbox"/> 14/pk. | <input type="checkbox"/> 24/pk. |
| 100-C <input type="checkbox"/> 13/pk. | <input type="checkbox"/> 22/pk. |
| 120-C <input type="checkbox"/> 13/pk. | <input type="checkbox"/> 22/pk. |
| 150-C <input type="checkbox"/> 13/pk. | <input type="checkbox"/> 22/pk. |

No Load Finishing Paper

- | | |
|---|-----------------------------------|
| 50/pk. | 100/pk. |
| 180-A <input type="checkbox"/> \$11/pk. | <input type="checkbox"/> \$19/pk. |
| 220-A <input type="checkbox"/> 11/pk. | <input type="checkbox"/> 19/pk. |
| 280-A <input type="checkbox"/> 11/pk. | <input type="checkbox"/> 19/pk. |
| 320-A <input type="checkbox"/> 11/pk. | <input type="checkbox"/> 19/pk. |
| 400-A <input type="checkbox"/> 11/pk. | <input type="checkbox"/> 19/pk. |

Wet or Dry S/C Paper

- | | |
|---|-----------------------------------|
| 50/pk. | 100/pk. |
| 220-A <input type="checkbox"/> \$15/pk. | <input type="checkbox"/> \$25/pk. |
| 320-A <input type="checkbox"/> 15/pk. | <input type="checkbox"/> 25/pk. |
| 400-A <input type="checkbox"/> 15/pk. | <input type="checkbox"/> 25/pk. |
| 600-A <input type="checkbox"/> 15/pk. | <input type="checkbox"/> 25/pk. |

NEW ITEM!

BELT CLEANING STICK - \$6.95

Prompt delivery from stock. **MONEY-BACK GUARANTEE**

Shipping Charges - Under \$35 add \$2.50; \$35 or more add \$4.00 — PA residents add 6% sales tax.

Check or Money Order.

MasterCard VISA Exp. Date _____

Acct. # _____

Name _____

Address _____

City, State & Zip _____

CALL TOLL FREE

1-800-428-2222

PA Only - 1-800-222-2292

INDUSTRIAL ABRASIVES CO.

643 North Eighth Street

Reading, PA 19603

WOOD REPAIR

Durham's Rock Hard Water Putty makes lasting repairs in wood. Won't shrink or fall out. Sets quickly, holds tight and can easily be painted. Economical, easy to use. Available at lumber, paint and hardware stores.



DONALD DURHAM COMPANY
Box 804-W Des Moines, IA 50304

WOOD TOY

- ★ Patterns
- ★ Parts
- ★ Wheels
- ★ Many New Patterns to Choose from.
- ★ Executive toys



SEND \$1.00 FOR NEW CATALOG & RECEIVE COUPON FOR FREE WHEELS & AXLE PEGS.

toys and joys

Box 628W Lynden, Wash. 98264

A Complete New Combination Kit for Whittling and Carving By WARREN TOOL CO., INC.

BASIC WOODCARVING



Basic Woodcarving lesson book, prepared by the National Carvers Museum, teaches and illustrates proper carving techniques through clear instructions and simple projects.

COMBI-TCE \$79.95 + \$2.25 p&h
OUR FINEST COMBINATION WHITTLERS AND CARVERS KIT Contents: 1 Redwood Box, 1-# CWH-R Rosewood handle, 1-# L-Palm Walnut handle, (one each) #PTV-1, #LBG, #SBG, #PTV-2, #STC, #STG, #SFTG, #SKU, Gouges, 1-# LD2 (Large Blade), #6SBL (6-Small Blades), 1-Leather Strop Block, 1-Abrasive Paper Block, 1-Instruction Booklet. All blades and gouges sold in their own plastic storage tubes to avoid damage to these honed ready-to-use tools.

WARREN TOOL CO., INC.

Rt. 1, Box 14A-W, Rhinebeck, NY 12572
Catalog 60¢ FREE with order • (914) 876-7817
N.Y. residents add 5.25% sales tax • Foreign shipping: *all foreign orders (including Canada) send MO in US funds plus additional \$1.75 for P&H.

DOWELS - PLUGS - PEGS

Manufacturer Direct
Largest & finest selection Oak, Walnut, Hickory, Maple, Cherry, Mahogany, Teak, even Treated Dowels. Quantity discounts.

MIDWEST DOWEL WORKS, INC.

4631 Hutchinson Road
Cincinnati, Ohio 45248
(513) 574-8488



DOWELS
¼" - 2" Diameter



3½" Length

SHAKER PEGS

Hard Maple
Poplar
Oak, Red or White
Walnut
Also Mini-Pegs

DUTCH WALL PEG

Hard Maple
Oak
Walnut



4" Length

Catalogue on Request

BAND SAW OWNERS!

A NEW TOOL is now available so you can make or repair any length Band Saw Blade in minutes!

This patented tool was developed for use in our own shop and has proven itself with thousands of high quality, true running splices.

Our splicer enables any craftsman to make up any length blade from economical coil blade stock QUICKLY and EASILY. The resulting silver brazed joint normally outlasts the service life of the blade.

Three models are currently available:

1C-001 ¼" to ¾" Blades \$ 49.95 ppd
1C-002 ½" to ¾" Blades 49.95 ppd
1C-003 ¾" to 1½" Blades 150.00 ppd

The tool comes complete with detailed instructions and supplies for approximately 100 splices.

We also carry additional supplies and OLSON band saw stock at reasonable prices.

Send L.S.A.S.E. for FREE information to:

NEW MILFORD SPECIALTIES CO.
Dept. BH, 24A South Main Street
New Milford, CT 06776
(203) 426-4276

Van Dyke's

Presents a
Catalog

with supplies for upholstery, antique restoration, wood working, caning, brass hardware, carvings and many related trades!

36 Years in Creative Arts & Trades

Many Hard-To-Find Items!

SEND \$1.00 FOR CATALOG TO:
Van Dyke's Restorers
Dept. D55 - Woonsocket, SD 57385



SPECIAL OFFER BRANDING IRON

For hard and soft wood



\$2400

Plus \$2.00 for shipping and handling
Nebr. residents add correct sales tax
SATISFACTION GUARANTEED or your money back

- Shipped in 1 week
- Solid brass head — deep cut letters
- First Line: HAND CRAFTED BY — as above
- 2nd line: Your choice — 20 characters/spaces max.
- Compact size
- As above but with 3rd line — \$37.00 + \$2.00

ORDER TOLL FREE 1-800-826-7606 (except Nebraska)
In Nebraska 1-402-464-0511

Brochure/info on other models, write or call (402) 464-0511

Order by mail from: **NOVA TOOL CO.**

4533 Colfax Circle, Dept. BH87
P.O. Box 29341, Lincoln, NE 68529



BACKYARD STRUCTURES



Storage Designs with a Difference

Included are 65 Full Color designs for Storage Sheds, Animal Shelters, Barns, Studios, Cabanas, and Garbage Enclosures with mini-plans for 8 structures. All this in our book **Backyard Structures** for only **\$8.95** plus \$1.50 postage and handling. Full construction plans for all designs are available.



P.O. Box 206
Dept. 34
Delafield, WI 53018
(414) 567-4255

MONEY BACK GUARANTEE - MC & VISA ACCEPTED

FREE COPY!

SCALE WOODCRAFT magazine is all about making things to scale in wood...how to do it yourself as well as fascinating looks at what other carvers and model makers are up to.

Whether you are a plank-on-frame modeler, a carver of decorative water fowl, or a builder of miniature interiors, you'll find plans, ideas and articles to captivate and delight you.

Send for your FREE copy of SCALE WOODCRAFT today. At the same time we'll enter a trial subscription for 1 year (4 additional issues) for just \$14.95. You can cancel at any time after examining your free copy.

SCALE WOODCRAFT MAGAZINE, Dept. 2717
1000 Federal Rd., Brookfield, CT 06804
(203)775-5000



TOOLMARK

We offer a complete line of wood lathe accessories including:

- SAFETY SHIELDS
- SPINDLE DUPLICATORS
- DUPLICATOR SYSTEMS
- BOWL TURNERS
- STEADY RESTS
- U-TOOL WOODSHIVERS
- UNI-CENTER SYSTEMS

For free literature and price list call or write

TOOLMARK CO.
6840 SHINGLE CREEK PARKWAY
MINNEAPOLIS, MINNESOTA 55430
612-561-4210

We offer the best accessories at a good price.

Information

WORTH WRITING FOR

You can get useful ideas and product information by mail. Use the coupon in this section to order your choice of literature listed below.

POWER TOOLS

SCROLL SAW AND LATHE INFORMATION — More than 20 pages of information, including full-color photos, on HEGNER precision scroll saws, HEGNER lathes, and HEGNER duplicators. Find out why these machines are considered state of the art, and what to look for when shopping for scroll saws or lathes. AMI, LTD. \$1.00. *Circle No. 3.*

WOODWORKING PROFESSIONALS ONLY — Now save 50% on machinery, 70% on operating costs! How? By using the world's finest production quality universal machine. Commercial durability, utmost precision, set-up in seconds. No other tool combines usable capabilities like FELDER. Thousands sold all over the world. Now available in America through AMI. Send for brochure. AMI LTD. \$1.00. *Circle No. 4.*

ANDREOU INDUSTRIES—INTRODUCING MINI MAX—Send for our complete woodworking machinery catalog, also featuring Andreou Machinery, Powermatics, Freud, & many others. Full line of table saws, joiners, planers, shapers, sanders, lathes, dust collectors, bandsaws, vertical panel saws, overhead routers, drill presses, combination machines, cut off saws, stroke sanders, etc. We carry all sizes from small to large for all your woodworking needs. Send for catalog. ANDREOU INDUSTRIES. \$2.00. *Circle No. 8.*

THE FIRST LINE IN JIG SAW — BOSCH — Bosch gives professionals a selection of top-of-the-line jig saws as well as an impressive selection of blades. Wholesale prices. Send for literature. AVIATION INDUSTRIAL SUPPLY. 50¢. *Circle No. 12.*

MULTI-PURPOSE HOME WOODWORKING SYSTEM - The Emco Start-2000 is a table saw, band saw, moulding machine and disc sander and you can change operations in less than 30 seconds. One big 2 hp. motor does it all. With optional accessories you can do wood turning, mortising, horizontal drilling, and more. Send for four-color information. EMCO* USA. Free. *Circle No. 36.*

STATIONARY POWER MACHINES — Available from Elektra Beckum U.S.A. Corp. — advanced technology woodworking stationary power machines with the unique Unimex Motor interchangeable concept. For complete information on Joiner/Planer, Bandsaw, Dust Extractor, Spindle/Moulder, Lathe and Combi Saw send for our catalog. ELEKTRA BECKUM U.S.A. CORP. \$1.00. *Circle No. 39.*

INCA MACHINERY INFORMATION—Complete information on the famous line of Inca Swiss woodworking machines. Designed for precision work by the small to medium sized cabinet shop. Used by thousands of hobbyists and professionals. Table saws, bandsaws, joiner/planers, dust collector, radial arm saw. GARRETT WADE CO. Free. *Circle No. 44.*

POWER TOOLS FOR WOODWORKING — Sold for 40 years. Plans & kits of metal parts to build sturdy power tools that last for years. 5-yr. warranty on parts. Kits & plans \$39-\$189. Simplified step-by-step plans with full sized patterns for wood base may be ordered separately. Parts & accessories sold individually. Send for descriptive brochure & prices. GILLION MFG. INC. \$1.00. *Circle No. 47.*

BEST VALUE IN WOOD LATHES—Wood turning has never been easier than with the 14" multi-speed wood lathe from Great Plains. Precision duplicator is standard equipment. Cast iron construction assures stability and longlasting service & eliminates vibration. Stainless steel ways for smooth movement. 45 day in-shop trial. Easy terms available. GREAT PLAINS MACHINERY CO., INC. \$1.00. *Circle No. 48.*

BEST VALUES IN WOOD PLANERS—Save big with the big capacity 15"x6" planer from Great Plains. The savings from buying rough-cut lumber and sizing & finishing in your own shop will pay for this machine in no time! Cast iron construction assures a lifetime of service. 45 day in-shop trial. Easy terms available. GREAT PLAINS MACHINERY CO., INC. \$1.00. *Circle No. 49.*

HOUSE OF TOOLS, LTD.—Western Canada's most complete selection of quality tools & machinery. Over the last 25 years, our company has become synonymous with superior quality woodworking tools & machinery. Contact us for any of your requirements or send for our new pair of catalogs. HOUSE OF TOOLS, LTD. \$2.00. *Circle No. 50.*

IF YOU ARE INTERESTED IN FINE WOODWORKING — you will not find better machinery than that sold by J.P. Humfrey Ltd. For example, we have 10-in. general tablesaws (2 HP, magnetic switch, lever-lock fence) available at \$1,295 FOB New York. Send for brochure. J. PHILIP HUMFREY LTD. \$1.00. *Circle No. 51.*

AMERICAN-MADE WOODWORKING EQUIPMENT — The RBI Hawk line of precision scroll saws in models from 12 to 26 inches. Unique patent pending cam tensioning system allows quick resetting of blades when doing inside cuts. RBI line of woodplaners, models 408 and 612; over 50 years experience in building wood thickness planers coupled with patented quick change cutterhead, to allow fast and easy changeover to molder or sander, make the RBI the best value on the market today. 30-day In-Shop Guarantee of Satisfaction. RB INDUSTRIES, INC. Free. *Circle No. 85.*

SUNHILL OFFERS TOP OF THE LINE IMPORTED MACHINES—for the serious DIY and professional woodworker. Our full line of stationary power tools is sold and serviced by over 50 authorized dealers across the U.S. Send for information. SUNHILL ENTERPRISES. \$1.00. *Circle No. 91.*

MOULDER-PLANERS FROM WILLIAMS & HUSSEY—Mould, plane, and edge, convert from moulder to planer in less than 2 minutes. The W-7 series is available in 3 models for manual, power in feed, or power in feed/out feed. The units plane to a satin, almost sanded finish, produce doll house to crown sized mouldings, raised panels, and virtually any shape profile. Custom knives available up to 7" wide and 3/4" depth of profile. Rugged, well-made, dependable, and transportable. Complete with sturdy movable stand. Send for catalog. WILLIAMS & HUSSEY. \$1.00. *Circle No. 93.*

WOODWORKING MACHINERY CATALOG — Workbench Tool Co. is now offering the Powermatic 26 spindle shaper, 3 hp., 1 ph., 1/2 to 3/4 in. spindles, reversing switch for only \$1625 FOB. Send for catalog. WORKBENCH TOOL CO. \$2.00. *Circle No. 95.*

IS THIS THE WORLD'S BEST JOINER-PLANNER? — We think so and invite you to take a closer look! MiniMax's new FS-35 joiner-planer combines industrial quality with an affordable price that will appeal to professionals and amateurs alike. THE XYLOPHILES CO. \$1.00. *Circle No. 97.*

HAND TOOLS

FINE HAND TOOLS FROM AROUND THE WORLD—Our 1987 hand tool catalog features tools from the Orient, Great Britain, Germany, & right here in the U.S.A. Select from the best quality tools at a price only a volume supplier can provide. HILLER HARDWARE. \$1.00. *Circle No. 120.*

PERSONAL BRANDING IRONS — Brochure describes branding irons that enable you to put your name on your work quickly and easily. Made especially for branding wood, they are available with 1, 2, or 3 lines of copy or with your logo. Changeable date also available. NOVA TOOL CO. \$1.00. *Circle No. 160.*

THE JAPAN WOODWORKER'S 1986 CATALOG — is loaded with the best tools you can get your hands on. In our catalog you will find a complete selection of Japanese tools for the woodcarver, carpenter, and cabinet maker. Send for catalog plus supplements for next two years. WOODLINE-THE JAPAN WOODWORKER. \$1.50. *Circle No. 190.*

STAINS/FINISHES

BEAUTIFUL WIPE-ON WOOD FINISHING — is explained in a booklet from a pioneer in wipe-on finishes since 1928. Wood finishes that produce a beautiful hand-rubbed finish without messy brushes or spraying. Specially formulated finishes that simply wipe-on with professional results every time — guaranteed! Unlike conventional finishes these will never yellow, crack, or craze and they dry dustfree without runs. These finishes will bring out the natural beauty of the wood and never needs waxing. Send today for your wood finishing guide and products catalog. GENERAL FINISHES. 25¢. *Circle No. 225.*

PEG-1000 WHOLESALE — Polyethylene glycol green wood stabilizer, 10 lbs. \$19.00 plus \$3.20 shipping. Send for additional information. GENERAL FINISHES. 25¢. *Circle No. 226.*

BEAUTIFUL WOOD FINISHING — with Watco Danish Oil Wood Finish. Full-color *How to Beautifully Finish Wood* booklet enables anyone to create professional finishes the first time with all types of wood. One application of Watco

Wood Finish seals, primes, finishes, hardens, protects, beautifies, penetrates deeply into the wood; outlasts surface coats three to one. Eight attractive Danish Oil colors now available. Eliminates pre-staining. WATCO-DENNIS CORP. Free. *Circle No. 270.*

PLANS

OVER 500 WOODWORKING DESIGNS — We now offer thirty-nine packets of blueprint plans and full-size patterns with both the home and commercial craftsman in mind. Enjoy making toys, games, children's items, whirligigs, folk art, plaques, magazine racks, shelves, kitchen and household items, birdhouses, plant stands, and more. Simple enough for the beginner, fun and profitable for the pro. Send for illustrated brochure plus sample pattern. ACCENTS IN PINE. \$2.00. *Circle No. 310.*

WOODWORKERS' PLANS AND SUPPLIES — Wood projects are simplified with the high quality plans, specialty hardware and other supplies offered by Armor Products. Over 100 plans are available for making toys, desks, clocks, pool tables, lamps, chests, and other furniture. Movements, dials, moldings, ornaments, and hardware also available. ARMOR PRODUCTS. \$1.00. *Circle No. 315.*

CATALOG OF PLANS AND KITS — A selection of functional projects, unique gifts, and decorative pieces for home or office. Included are a sandpile scooper, super bunk beds, miniature two-story outhouse, birthday calendar, and many more. See our ad elsewhere in this issue. BALLART DESIGN. \$1.00. (Refundable) *Circle No. 320.*

PLANS AND PATTERNS — This large selection of plans includes furniture designs, loom, spinning wheel, clocks, doll houses and furniture, cradles, toys, alphabets, bird houses, weathervanes, cedar chest, and much more. CRAFTPLANS CO. 50¢. *Circle No. 325.*

PATTERNS BY DESIGN GROUP — Hundreds of interesting, useful and fun items to create for personal use or profitable sale. Our 1987 catalog contains plans for toys, games, plaques, puzzles, birdhouses, planters, furniture, and much more! All Design Group patterns are professional, "same size" blueprints. No enlarging or reducing is necessary. Simply trace outline of item onto wood and create! Started in 1977, Design Group has sold thousands of patterns to thousands of satisfied customers. Prices start at \$1.00, all patterns come with a full money-back guarantee. Wholesale and bulk prices are available on request. Fully illustrated catalog. DESIGN GROUP. \$1.00. *Circle No. 340.*

CEDAR-LINED HOPE CHEST PLANS—Build this heirloom quality chest using our complete plans and instructions. The chest uses stile and rail construction with traditional raised-panels. The original prize winning chest is built of natural pine, but can also be built with hardwood. Send for information sheet. FINELINE CREATIVE DESIGNS. \$1.00. *Circle No. 342.*

PLANS AND PATTERNS FOR WOODWORKERS — New unique woodworking plans and patterns. Select Patterns for wooden toys or novelty decorations. The plans are fully illustrated with step-by-step instructions and photos. Send for a brochure today. FUNWOOD CRAFTS & TOYS. \$1.00. *Circle No. 343.*

FULL-SIZE FURNITURE PLANS CATALOG — Illustrates and describes over 180 plans for making furniture of quality found in museums and fine furniture stores. Plans include rolltop desk, cradles, dining tables, chairs, buffets, chests, gun cabinets, poker table, children's furniture, rocking horse, spinning wheels, and more. Bill of materials exploded drawings assist the woodworker. FURNITURE DESIGNS, INC. \$2.00. *Circle No. 345.*

COUNTRY FURNITURE PLANS — Our catalog features 24 designs — from country pie safe to mini-barn. Also included are various products for the home workshopper. Send for our latest catalog. Price of catalog deducted from your first order. HAMMERMARK ASSOCIATES. \$1.00. *Circle No. 370.*

WOODWORKING PLANS — Catalog of full-size plans printed on heavy paper for toys, gifts, novelties, action windmills, shelves, birdhouses, garden furniture, Dutch windmill, lawn ornaments, old-fashioned lawn swing, jigsaw projects for children, and more. MASTERCRAFT PLANS WEST. \$1.00 (refunded with first order). *Circle No. 390.*

HUNDREDS OF FREE PLANS—Timbers Woodproject Directory is described in this catalog of woodworking patterns. The directory guides you to 768 plans, 250+ are available free. Also featured are hundreds of full-size plans for antique & modern furniture, patio furniture, toys, rocking horses, whirligigs, office furniture, lamps, clocks, planters, musical banks, plus many instruction & pattern books. Premium quality wood parts at competitive prices complete

this fine catalog. TIMBERS/LAKE TAHOE, INC. \$1.00. *Circle No. 461.*

TOYMAKERS SUPPLIES — Catalog of over 100 full-size wooden toy patterns — classic to contemporary designs from Packard Le Baron to Streamlined train and moon machine. Easy to follow, fully illustrated patterns which appeal to all ages. Hardwood wheels (plain or spoked), shaker pegs, axles, etc. in stock. Accessory kits of pattern and turnings available. TOY DESIGNS. \$1.50. *Circle No. 465.*

WOODWORKING/CRAFT SUPPLIES & BOOKS — Brochure of complete kits & woodworking books. Ready to assemble wood kits for dollhouses, classic cars, bird-feeders, boats, trains, trucks, wood clamps & more. Model airplanes that really fly—rubber band motored. Ready to finish contoured wood teddy bears with glass eyes & moveable limbs. Duck & shorebird decoys & wooden fruit ready to paint. TOY DESIGNS. \$1.00. *Circle No. 466.*

PROJECT PLANS FOR WOODWORKERS — Professionally designed projects include furniture, playthings, and accessories, to more complex projects such as storage sheds and gazebos. These plans are designed using readily available materials, keeping in mind standard sizes of lumber. Instructions are clear and concise, and occasionally include tips that will make your job easier. Some plans have a cut-out materials list to take with you to the lumber yard. All plans are current, and we are constantly adding to our line. Order our catalog now and get started! THE WORKSHOP BLUEPRINT CO. \$2.00. *Circle No. 485.*

LUMBER

WOODWORKERS! HELP CELEBRATE OUR 55TH YEAR OF SERVICE — Send for our new 148-page Craftsman 1985 catalog. 42 varieties of choice hardwoods 1/4- in. to 4-in. thickness. Fine hardwood veneers, tools, moldings, trim, marquetry inlays, upholstery and lamp supplies, finishes, clock kits, and hard-to-find hardware. 4,000-plus items for your projects. CRAFTSMAN WOOD SERVICE CO. \$1.00. *Circle No. 520.*

EdLco — WE KNOW OUR LUMBER — Educational Lumber Company is pleased to offer you our new catalog, stacked with excellent buys at delivered prices. Available to you are over 21 species of imported as well as domestic hardwoods, softwoods, turnings, shorts, veneers. All our lumber is kiln dried. As school shop suppliers for 35 years, we know our lumber. It is top-grade. Send today and receive your BONUS GIFT: 4 new furniture designs. EDUCATIONAL LUMBER CO., Inc. \$2.00. *Circle No. 530.*

MACASSAR EBONY — Professionals agree it's one of the world's hardest, rarest, and most beautiful woods. Macassar is coveted by woodworkers, artists, turners, and connoisseurs for its marbelike beauty and durability. We have the largest commercial selection of dimensional stocks in the U.S., from 1 to 8 inches thick and from 4 to 20 inches wide in random lengths to 9 ft. These are virtually unavailable elsewhere at any price. As a direct importer, we offer the lowest prices anywhere with no minimum orders. Send today for a complete description, inventory and price list (refundable with first order). ART EISENBRAND, INC. \$1.00. *Circle No. 535.*

THIN LUMBER — Approximately 20 species of thin lumber, widths vary up to 3/4-in. Kiln dried. Turning squares. Send for price list. HARDWOODS OF ILLINOIS. 50¢. *Circle No. 545.*

THE BEST LUMBER AT THE RIGHT PRICE—Located in close proximity to some of the most ideal growing ranges for Red Oak, Pennsylvania grade Cherry, Hard Maple, Ash, Poplar, and other hardwoods, we can supply your needs with the highest quality hardwoods. Our experience in hardwood purchasing and our dedication to keeping our overhead low is your guarantee of low prices. No minimum order. Retail and wholesale. Send for price list, NORTH EASTERN HARDWOODS. 50¢. *Circle No. 563.*

LUMBER DRYING — Nyle Corp., the largest manufacturer in the United States of dehumidification Dry Kiln Systems, offers *Introduction to Dehumidification Lumber Drying*. NYLE CORP. Free. *Circle No. 565.*

GENERAL WOODWORKING CATALOGS

TOOL CATALOG — Available from Anglo American Enterprises, the world famous Record Marples Tool Catalog featuring the finest woodcrafting tools available. Send for catalog and price list. ANGLO AMERICAN ENTERPRISES CORP. \$2.00. *Circle No. 803.*

FINE WOODS AND WOODWORKER'S SUPPLIES — Constantine's 175th Anniversary Catalog offers 116 pages, many in full color, of 150 kinds of veneers, over 250 sizes of cabinet hardwoods. Inlays, moldings, brass cabinet hardware, cane. Specialty woodworking tools, wood finishes, plans & books. Serving the woodworker since 1812. ALBERT CONSTANTINE AND SON, INC. \$1.00. *Circle No. 820.*

AN IMPRESSIVE RANGE OF FINE WOODWORKING TOOLS — at affordable prices, is displayed in the Fine Tool Shops catalog. Each year very many new products are introduced. Some recent additions include a 6-ft. teak workbench, a wide range of woodworking videos available for rent at \$10.00 per mo., a good selection of American hardwoods, pneumatic sanding drums, and hand forged tools made in Maine. Send for catalog. FINE TOOL SHOPS. Free. *Circle No. 850.*

WOODWORKING TOOL CATALOG — Complete 108-page catalog of hard-to-find hand woodworking tools. We have a stock of over 300 book titles and carry the Myford English wood-turning lathe. Also inventoried are wood finishes of all possible descriptions and carving tools unequaled anywhere in the United States. Send today for your ticket to woodworker's heaven. You too, can be turning out quality woodwork. FROG TOOL COL, LTD. \$1.00. *Circle No. 853.*

MAIN TOOLS CATALOG—1986-87 master woodworking tools catalog. Full line of the best hand tools, power tools & accessories, machinery, glues, finishing supplies, and much more. Hundreds of books included. 212 pages. All four-color. Lots of technical information. GARRETT WADE CO. \$4.00. *Circle No. 855.*

HARDWARE CATALOG—A unique catalog of the very finest in classic, traditional solid brass cabinet hardware. All of British or No. American manufacture. Double & single post handles, knobs, escutcheons, standard & specialty hinges, box hardware, brass screws, castors, latches, catches, locks, and more. GARRETT WADE CO. \$1.00. *Circle No. 856.*

WOODWORKING MACHINERY CATALOG — Just arrived — 1986 full-color catalog of quality imported machinery and tools at low prices. GRIZZLY IMPORTS, INC. Free. *Circle No. 860.*

PLANERS — Heavy duty 15x6 in. planers with 2 hp. single-phase motors. Other woodworking equipment at low, low prices. Send for 1986 color catalog. GRIZZLY IMPORTS, INC. Free. *Circle No. 861.*

DUST COLLECTORS — for the small/medium size shop. Capable of handling from 1 to 3 machines at the same time. Priced within the home shop budget, yet capable of handling cabinet shopwork. Other woodworking machinery and tools — low prices. Send for catalog. GRIZZLY IMPORTS, INC. Free. *Circle No. 862.*

THE 1987 HILLER HARDWARE CATALOG—is a comprehensive collection of tools & accessories for you. Select from the best quality tools in the business at a price only a volume supplier can provide. Power tools, hand tools, cutters, blades, & accessories. 24 pages, over 240 tools! HILLER HARDWARE. \$1.00. *Circle No. 875.*

WOODWORKING TOOLS, MACHINERY, & SUPPLIES—W. S. Jenks & Son's new 150+ page source book is packed with a full range of tools for the serious woodworker, from hand tools to portable power tools, to woodworking machinery. Includes many imported and hard to find tools, from the best manufacturers at the most competitive prices. Send for catalog. W. S. JENKS & SON. \$2.00 (refundable with first order). *Circle No. 877.*

WOODWORKING TOOL CATALOGS — R.A. Ness & Co., the Woodworkers Emporium, offers a 2-year subscription, a total of eight huge sale catalogs. Thousands of industrial quality items — machinery, hand tools, portable electric tools, and supplies — are featured at super sale prices. The fee is refundable with purchase. R. A. NESS & CO., the Woodworkers Emporium. \$4.00. *Circle No. 900.*

WOODWORKERS CATALOG — More than a catalog — it's one of the best sources for quality woodworking tools. You'll find everything from bit braces to wood borers, from saws to sharpening stones. Every product is sold satisfaction guaranteed. WOODCRAFT SUPPLY CORP. Free *Circle No. 955.*

KITS

DO-IT-YOURSELF GRANDFATHER CLOCK KITS — Direct from world's largest manufacturer of grandfather clock kits. Prices starting at under \$280 including West German Westminster chiming movement. Choose from black walnut, cherry, and oak. Other quality heirloom kits also available. Send for catalog. EMPEROR CLOCK CO. \$1.00. *Circle No. 1030.*

QUALITY CLOCK KITS AND PLANS — Handmade and semi-assembled of carefully selected 3/4 in. cherry, oak, or walnut with beveled glass. Or build from "scratch" using our detailed plans and trim pieces. Choice of quality movements. Established in 1916. KUEMPEL CHIME CLOCK WORKS. \$2.00. *Circle No. 1050.*

WOODEN SHIP MODELS — Discover the world's hobby — building fine-quality, historic wooden ship models. Described are true-to-life scale replicas, lifelike in every detail. A 64-page color catalog introduces you to this fascinating hobby. MODEL EXPO, INC. \$1.00 (Refundable with first order). *Circle No. 1060.*

SOLID WOOD CLOCK KITS — Full-color catalog of beautiful, easy-to-make clocks. All solid wood with solid brass pre-assembled movements. All parts hand cut for perfect assembly, even by beginners. VIKING CLOCK CO. 50¢. *Circle No. 1090.*

PUBLICATIONS

WHAT ARE YOUR OLD TOOLS WORTH? — New illustrated Collector's Guide gives history and current dealer and auction prices for the products of Stanley, Bailey, Disston, KeenKutter, Sargent, Simmons, Winchester, and dozens of lesser known brands made from 1840 to 1940. Just a few of the over 5,000 items described and priced: adzes, anvils, axes, braces, chisels, compasses, dividers, hammers, hatchets, knives, lathes, levels, planes, plumb bobs, rout-

ers, rules, saws, screwdrivers, spoke shaves, wrenches, and wheelwright's items. Over 2,000 illustrations. First edition, 230 pages, 9x12 in. paperback, Library of Congress #84-50055. Now is the time to identify and price all of your old tools. Just one find could pay for this new book, many times over! WINDMILL PUBLISHING CO. \$14.00. *Circle No. 1190.*

SHOP ACCESSORIES

RIPSTRATE SAVES FINGERS — for table saw and radial arm saw users. Brochure describes the RIPSTRATE and shows how it gives straighter cuts, speeds, the work, prevents kickbacks, and keeps hands away from the blade. FISHER HILL PRODUCTS. 25¢. *Circle No. 1235.*

EASY DOES IT — with HTC's power tool accessories. Discover many unique items, designed only with you, the dedicated woodworker, in mind. Make your machinery safer, increase the working area of your shop and accomplish nearly impossible tasks easily, quickly, accurately. Full-line catalog and price list. HTC PRODUCTS, INC. \$1.00. *Circle No. 1245.*

CLASSIC WORKBENCH—This is a space saver's dream. Assembled & knocked down in minutes. Beautifully designed workbench is made of Danish Red Beech with a linseed oil finish. Other features include built-in, precision steel spindle rises & dogs. Send for literature. LAGUNA TOOLS. \$1.00. *Circle No. 1249.*

DRUM SURFACE/THICKNESS SANDER — Now a radial arm saw accessory providing inexpensive, space saving surface/thickness sanding capability. Product features include: instant attachments to all radial saws, 44 in. sanding width, sanding drum with sandpaper fasteners, and vacuum dust collection. Send for information. PERFORMAX PRODUCTS. \$1.00. *Circle No. 1253.*

CREATE ANY HOLLOW CYLINDRICAL SHAPE — with 1/4 in. wall thickness, 12 in. diameter. Ring Master cuts perfect rings in any wood, any angle, any size—stack the rings and create any cylindrical shape. Just glue—sand, & finish, all on the Ring Master. Create matched sets of items. Choose from 2 models, 1 attaches to Shopsmith Mark V. RING MASTER, INC. Free. *Circle No. 1265.*

PROFESSIONAL SANDING EQUIPMENT — Sand-Rite's Brush Head sands moldings and intricate carvings without losing detail or shape of the part. Pneumatic drum gives quick and excellent results on contoured shaped parts. Everything we sell is industrial quality. Send for brochure. SAND-RITE. Free. *Circle No. 1275.*

THE PERFECT SET-UP — Set of six large angles — 15°, 18°, 22.5°, 30°, 45°, and 60°, with attaching bar for setting miter & bevel on radial arm saws. A precision cut every time. Many uses in the shop or home. Constructed of durable plastic; will not damage blade. A must for every shop. Patent pending. Send for literature. ROBERT S. SMITH, INC. \$1.00. *Circle No. 1279.*

FREE: HOW TO SAVE TIME AND MATERIAL — Work with confidence and control. SHOPHELPER Safety Guides provide stability, to help eliminate binding, chatter, and kick-back. With an extra pair of hands from SHOPHELPER you can hold work firmly on table and radial saws, shapers, band saws, and others. Complete information from WESTERN COMMERCIAL PRODUCTS. Free. *Circle No. 1290.*

ROUTER BITS AND SAWBLADES

CARBIDE TIPPED ROUTER BITS AND SHAPER CUTTERS — Over 200 router bits and shaper cutters displayed in catalog featuring 6 piece cabinet sets, 3 piece 1/2 in. shank router bit panel raising system, and 3 wing industrial shaper cutters. Shaper cutters available in 1/2 in. through 1-1/4 in. bore with bushings. Router bits offered in 1/4 in. and 1/2 in. shank. CASCADE PRECISION TOOL CO. \$1.00. *Circle No. 1315.*

CUTTING TOOLS — Freud provides the finest in handtools and carbide cutting tools. From chisels and planes to saw blades and router bits. All this and more. Send for catalog. FREUD. \$1.00. *Circle No. 1321.*

PRODUCTION QUALITY CARBIDE TIPPED ROUTER BITS — MLCS Ltd. offers a full line of professional production quality carbide tipped router bits at 50-70% lower than retail prices. We sell through the mail and only direct to craftsmen. Send today for information. MLCS LTD. Free. *Circle No. 1350.*

HARDWARE/WOOD PARTS

SPECIALTY WOODEN PARTS — Hundreds of turned wooden parts in maple, birch, oak, cherry, walnut, and colors for toys, furniture, games, and crafts. Included are Shaker pegs, mug pegs, gallery spindles, wheels, axles, balls, finials, smokestacks, plugs, buttons, people, pegs, cargo, game pieces, knobs, handles, candle cups, stool legs. Bulk prices available. Send for color catalog subscription. CHERRY TREE TOYS, INC. \$1.00. *Circle No. 1415.*

BRASS FURNITURE HARDWARE — This 36-page catalog shows over 500 items of authentic reproduction hardware from the 1700's and on into this century. This fine quality hardware is a must for the furniture craftsman working on a new project, or the refinisher who needs replacement hardware. HORTON BRASSES. \$2.00. *Circle No. 1430.*

WOODWORKER'S SPECIALTIES — 48-page catalog of plans and hard-to-find hardware for woodworkers. Dozens of wood toy plans & accessories, including wood wheels, fenders & decals. Also wood turnings, brass hardware, canister liners, stencil supplies, & wood cutouts. MEISEL HARDWARE SPECIALTIES. \$1.00. *Circle No. 1455.*

TOYMAKER'S SUPPLY COMPANY—has your best bulk price on quality wooden toy parts and toy plans. Over 50 turnings to make your toys professional looking. Send for catalog. TOYMAKER'S SUPPLY CO. Free. *Circle No. 1475.*

WOOD TOY PATTERNS — Patterns for all ages including children's patterns and executive toys. New catalog has many new patterns to choose from including parts and wheels. Send for new catalog and receive a coupon for free wheels and axle pegs. TOYS AND JOYS. \$1.00. *Circle No. 1480.*

QUALITY AMERICAN-MADE WOOD TURNINGS — such as shaker pegs, spindles, toy wheels, toy parts, craft items, and dowel rods in birch, oak, walnut, and cherry. Send for complete 32-page catalog. WOODWORKS. \$1.00. *Circle No. 1490.*

INCOME OPPORTUNITIES

START SMALL BUSINESS WITH NEW SCROLL SAW — The Excalibur precision scroll saw from Canada can turn your workshop into a profit center. Make toys and puzzles, do intricate marquetry work or detailed cabinet work with these "operator friendly" machines. Hundreds sold in the U.S. already. Save, buy direct, from \$495. up. Complete project patterns and plans available. Send for brochure. J. PHILIP HUMFREY LTD. \$1.00. *Circle No. 1655.*

BUILDING CONSTRUCTION—Learn how to profit as an independent contractor or save thousands building your own home...with NRI at-home training in Building Construction. 70 lessons, plus over 100 practical hands-on projects cover the full spectrum of construction—from site selection to exterior finishing & landscaping. Send for catalog. NRI. \$1.00. *Circle No. 1665.*

DO-IT-YOURSELF BUILDING SUPPLIES

CUPOLA AND BRIDGE — Consists of designs for 22 foot bridges, 8 covered bridges, 36 cupolas, and some history of each. Complete plans available for each design. SUN DESIGNS. \$7.95. *Circle No. 1870.*

GAZEBOS AND OTHER GARDEN STRUCTURES — The most comprehensive collection of gazebo designs found anywhere today. Includes 55 gazebo designs from 8 ft. to 30 ft., 13 strombrellas, 7 arbors, 14 bird feeders, and 4 bird-house designs. Has mini-plans of 2 bird feeders and 1 of our most popular Tiffany gazebo. Complete construction plans can be ordered for all 93 designs. SUN DESIGNS. \$7.95. *Circle No. 1871.*

MISCELLANEOUS

PERSONALIZED BRANDING IRON — Personalize your finished projects with BrandMark's solid brass branding iron. Easy to use, lasts for years, satisfaction guaranteed. Makes an ideal gift. See ad elsewhere in this issue or send for brochure. BRANDMARK. 25¢. *Circle No. 1905.*

MAKE WOODEN TOYS — Whirligigs, doll houses, swing sets, classic autos, furniture and crafts with our plans, kits, parts, and supplies. For all skill levels. Also parts (toy, craft, game, and furniture) and dimensional lumber in maple, oak, walnut, and cherry along with specially brass parts, tools, books, organizers and finishes. Send for color catalog subscription. CHERRY TREE TOYS, INC. \$1.00. *Circle No. 1918.*

MAKE WOODEN CLAMPS — Save 60%. Kits and plans for 8, 10, and 12 in. wooden handscrew clamps. Acme threaded steel rods, components, handles and full-sized plans provided. Kits also available with uncut and precut maple jaws. You decide how much you want to save. Also available are hundreds of plans, kits, parts, and supplies for wooden toys and whirligigs in our beautiful color catalog. CHERRY TREE TOYS, INC. \$1.00. *Circle No. 1919.*

DUBUQUE CLAMP WORKS — The company serious about producing the BEST wood clamps and wood clamp kits. DCW clamps offer strength, durability, and reliability. Two kits available — Metal Hardware only or Metal Hardware Plus Maple Jaws and Handles. Send for literature. DUBUQUE CLAMP WORKS. \$1.00. *Circle No. 1949.*

LARGEST SELECTION OF MAKITA TOOLS & WOODEN TOY PARTS—Available for immediate delivery. Same day service. More than 100 premium quality wood parts. Order as few as 1 each. Combine quantities for discounts. Free shipping. No minimum order. For the right price on Makita, Bostitch, Stihl, Amana, & wood parts, send for brochure. HOME LUMBER CO. 25¢. *Circle No. 1972.*

BUY YOUR SANDING BELTS DIRECT FROM THE MANUFACTURER — Industrial Abrasives is the company that gives you six free belts with every dozen ordered. But, sanding belts are not the only product we have to offer. In our

catalog you will find many specialty items not readily available in your hardware store. Price of catalog refunded with first order. INDUSTRIAL ABRASIVES CO. \$1.00. *Circle No. 1975.*

THE CUSHION CONTOUR SANDER — is a new concept in pneumatic drum sanding. Sanding sleeves are slid over an air bag (inflated with a hand tire pump) on an arbor to mount it between centers on a wood lathe. Drum effectively takes on profiles, curves, and bevels practically eliminating flat spots and chatter marks. INDUSTRIAL ABRASIVES CO. Free. *Circle No. 1976.*

FREE LITERATURE — New brochure showing all moisture meters and accessories for moisture meters such as interchangeable electrodes and probes and cables for in-kill moisture monitoring. Complete line of moisture meters include: Pocket-size Mini-Ligno with LED readout 6%-20%, Mini Ligno E 6%-36%, analog or digital display meters 4%-30%, 60% and a digital moisture meter with built-in compensation for different wood temperatures. LIGNOMAT USA, LTD. Free. *Circle No. 1999.*

MERLE ADJUSTABLE CORNER CLAMP — Quick & easy to use. Fully adjustable from 2 1/2" to 36x36 in. Perfect for clamping picture frames, cabinets, or anything that requires 90° corner clamping. The Merle Clamp is cast aluminum & steel construction, a true industrial quality tool. Send today for information. MLCS LTD. Free. *Circle No. 2006.*

PERFECT EDGE-JOINING EVERYTIME — "Duo-Clamp" holds your boards flat while applying uniform yet firm pressure to squeeze out excess glue. Bowing totally impossible. The need for a surface planer is eliminated; a light belt sander finishes your job. Patent applied for. Easily assembled and unconditionally guaranteed. Made of sturdy maple. Send for information. MARK PRODUCTS. 25¢. *Circle No. 2009.*

WOOD CARVING — You can obtain information on learning woodcarving by sending for our literature. The offer includes sample copy of *The Mallet Magazine* and two lesson sheets on carving. NATIONAL CARVERS MUSEUM. \$1.00. *Circle No. 2021.*

BANDSAW OWNERS — A new tool is now available so you can make or repair any length bandsaw blade in minutes. Our splicer enables craftsmen to make up any length blade from economical coil blade stock quickly and easily. Three models are currently available to accommodate blade widths from 1/8 to 1 1/2 in. The tool comes complete with detailed instructions and supplies. We also carry OLSON bandsaw stock at reasonable prices. Send for literature. NEW MILFORD SPECIALTIES CO. 50¢. *Circle No. 2025.*

LETTER LAYOUT GUIDES — Brochure containing complete information about a new product of special interest to scroll sawers, carvers, and wood sign makers. A lettering

guide to layout large letters and numbers to be cut in wood or other materials. Made from a durable plastic material for years of use. Price of brochure is refundable with first order. SEYCO SALES CO. \$3.00. *Circle No. 2057.*

BACKYARD STRUCTURES — Contains designs for 21 really different storage sheds, 5 cabanas, 13 animal shelters, 3 barns, 13 garbage enclosures, 3 studios, and more, plus 8 plans in book. 66 designs in all, for which plans can be ordered. Full color. SUN DESIGNS. \$8.95. *Circle No. 2069.*

IF YOU ARE INTERESTED IN RESTORING ANTIQUES — this 160-page catalog packed with unusual, hard-to-find items is just for you. Included are hundreds of essential items for antique restoration including top quality brass reproduction hardware, oil lamps and accessories, numerous wood component repair parts and kits, caning and basketry supplies, everything needed for wood refinishing, related tools, books, and a complete line of upholstery equipment and supplies. All at wholesale prices. Send for this informative catalog. VAN DYKE' SUPPLY CO. \$1.00. *Circle No. 2077.*

WOODWORKING ASSOCIATION OF NORTH AMERICA — First international association for woodworkers. Benefits include our quarterly magazine *International Woodworking*, specials from selected manufacturers, group health and life insurance, access to the woodworking network. WOODWORKING ASSOC. OF NORTH AMERICA. 50¢. *Circle No. 2092.*

DOOR SHOP" MANUAL AND CATALOG — The 37-page Door Shop" manual is clearly written and beautifully illustrated with over 156 detailed drawings covering the complete process of door building. Each section covers proper methods and exact set-ups for the router, including how to recognize and correct for errors. There are sections covering design, lumber selection, measuring, panel raising, rail and stile fitting, guides, clamping, gluing, and finishing. This is the most comprehensive manual out today. When you purchase the Door Shop" manual for \$5.00 you also receive Zac's 26-page router bit and shaper cutter catalog free. And as an extra bonus you receive a hardwood door corner sample with your catalog order. \$5.00 rebated with purchase. ZAC PRODUCTS INC. \$5.00. *Circle No. 2098.*

CARVING SUPPLIES

WOODCARVING TOOLS — Whittlers and carvers — Warren Tool Co. offers a catalog for you full of whittling and carving hand/power tools, books, stones, wood, and supplies. Since 1927, the finest in woodcarvers tools. WARREN TOOL CO., INC. 60¢. *Circle No. 2185.*

Information

WORTH WRITING FOR

TO ENSURE PROMPT HANDLING OF YOUR ORDER FOLLOW THESE INSTRUCTIONS:

- Circle your choice
- Enclose cash, check, money order for cost of booklets plus \$1.00 service charge (no stamps/foreign)

- Send coupon and remittance to address above
- ALLOW 4-6 WEEKS FOR DELIVERY
- Coupon expires February 23, 1988

WOOD SUBSCRIPTION

1. A 1 year WOOD subscription (6 issues) for \$18.00 — a \$3.00 savings off newsstand rate. Allow 6-8 weeks for first issue. Add \$6.00 outside U.S. Be sure to include payment with total below.

FREE LITERATURE

Circle numbers below corresponding to items in this issue. Please include \$1.00 for handling charge

36	270	860	955	1290	1976
44	565	861	1265	1350	1999
85	850	862	1275	1475	2006

PRICED LITERATURE

Numbers below refer to items on which there is a charge. Please include proper remittance.

3.....\$1.00	95.....2.00	342....\$1.00	545.....50¢	1060....\$1.00	1455....\$1.00	1975....\$1.00
4.....\$1.00	97.....\$1.00	343....\$1.00	563.....50¢	1090.....50¢	1480....\$1.00	2009.....25¢
8.....\$2.00	120....\$1.00	345....\$2.00	803....\$2.00	1190...\$14.00	1490....\$1.00	2021....\$1.00
12.....50¢	160....\$1.00	370....\$1.00	820....\$1.00	1235....25¢	1655....\$1.00	2025.....50¢
39....\$1.00	190....\$1.50	390....\$1.00	853....\$1.00	1245....\$1.00	1665....\$1.00	2057....\$3.00
47....\$1.00	225....25¢	461....\$1.00	855....\$4.00	1249....\$1.00	1870....\$7.95	2069....\$8.95
48....\$1.00	226....25¢	465....\$1.50	856....\$1.00	1253....\$1.00	1871....\$7.95	2077....\$1.00
49....\$1.00	310....\$2.00	466....\$1.00	875....\$1.00	1279....\$1.00	1905....25¢	2092....50¢
50....\$2.00	315....\$1.00	485....\$2.00	877....\$2.00	1315....\$1.00	1918....\$1.00	2098....\$5.00
51....\$1.00	320....\$1.00	520....\$1.00	900....\$4.00	1321....\$1.00	1919....\$1.00	2185.....60¢
91....\$1.00	325....50¢	530....\$2.00	1030....\$1.00	1415....\$1.00	1949....\$1.00	
93....\$1.00	340....\$1.00	535....\$1.00	1050....\$2.00	1430....\$2.00	1972.....25¢	

Name (please print) _____
 Address _____
 City _____
 State _____ Zip Code _____

I AM ENCLOSING:

\$_____ for priced items
 \$ 1.00 for handling
 \$_____ total remittance

WOODWORKING FACTS, FACES, & FABLES

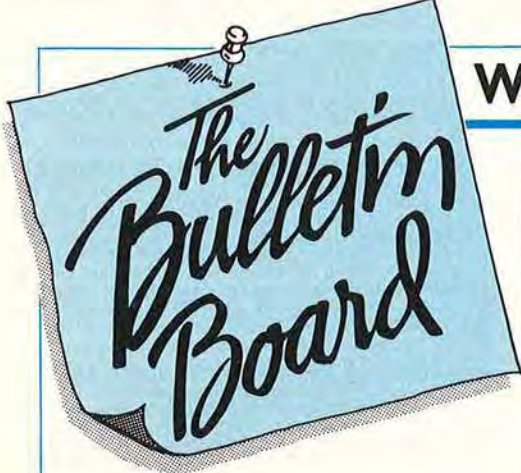

WOOD TO WET YOUR WHISTLE

Pioneer woodsmen on the American frontier used the inner bark of the slippery elm to quench their thirst when no water was handy. They peeled it from the tree and chewed it like gum.

HARDWOODS CAN BE HOT STUFF

Wherever hardwoods grow in plentiful supply, people who rely on wood heat value them as much for fuel as woodworking stock. When the weather turns brisk, BTUs become more important than board feet. (One British Thermal Unit, or BTU, equals the amount of energy needed to raise the temperature of a pound of water one degree Fahrenheit.) And some favorite hardwoods for woodworking rank as super fuel.

Measured in millions of BTUs per cord, here's how some of these favorites stack up:

HARDWOOD (One Cord)	BTUs (Millions)
Hickory	31
White oak, pecan	28
Red oak, hard maple	27
Ash	25
Elm, sycamore	21
Yellow poplar	18
Aspen, basswood	16

Except for ponderosa pine, which rates a relatively high 22, softwoods average about 16.

TALK ABOUT A TURNING!

For Des Moines-based architectural woodturner Mark Knudsen, who routinely turns large items such as posts and columns for buildings, it was the biggest bowl ever mounted on his lathe. Built up of Honduras mahogany segments band-sawn to rough shape, the "blank" measured 54" in diameter, was nearly 3' deep, and weighed 550 lbs. Not surprisingly, he needed a chain hoist to lift it in place on the faceplate!

Thirty hours later, over 300 lbs. of mahogany shavings lay on Mark's workshop floor. The newly turned bowl was 29" deep, with 1 5/8" thick sides.

Mark's turning work was finished, but there was still more to do with the huge, mahogany bowl. It was freighted to a St. Petersburg, Fla.

hotel, where a cabinetmaker halved it like a melon and used the curved pieces to top a pair of china cabinets in the refurbished grand banquet room.

Reflecting on his experience, Mark says he had only two problems: "The sides of the bowl actually moved in and out — kind of flapped — as I was turning it. That made it difficult to keep my gouge against the wood. And, because I had to slow the lathe down to 65 rpm's, the shavings didn't follow the bowl around and drop out the bottom when I was working inside — they got to the top, then rained down on my head!"

Mark Knudsen uses a 3/8", long-handled gouge to shear away mahogany from the largest bowl he has ever turned in his shop — 54" in diameter!



Photograph: Marlen Kemmet

THE WOODWRIGHT'S SHOP — CONTINUED

Colonial Williamsburg's master housewright, Roy Underhill, whose "Old Hand Ways" articles often appear in these pages, continues romancing us with stories about the skills of yesteryear. If you enjoy Roy's articles, we suggest you check your local pro-

gram guide for his new PBS television series called "The Woodwright's Shop." Much of the new version's content comes from Roy's recently released, third book, *The Woodwright's Workbook*, published by the University of North Carolina Press.

IT ALL ADDS UP

The value of a red oak tree increases about 37 times from when it's bought on the stump for commercial use to when it's sold retail as furniture. 🌲

Celebrating 50 YEARS of Special Interest Publishing...

For fifty years, we've been helping families with better living ideas for building, remodeling and decorating. So if you plan to do anything new for your home and family this year, get the best help around: Better Homes and Gardens® Special Interest Publications. We've got the practical, how-to advice you need to make your home life better than ever!



LITTLE ROOMS THAT DAZZLE
Making the most of small spaces
Weekend guide to fall fix-up



A KEEPING KITCHEN
This classic New England-style country kitchen doubles as a cozy family gathering spot

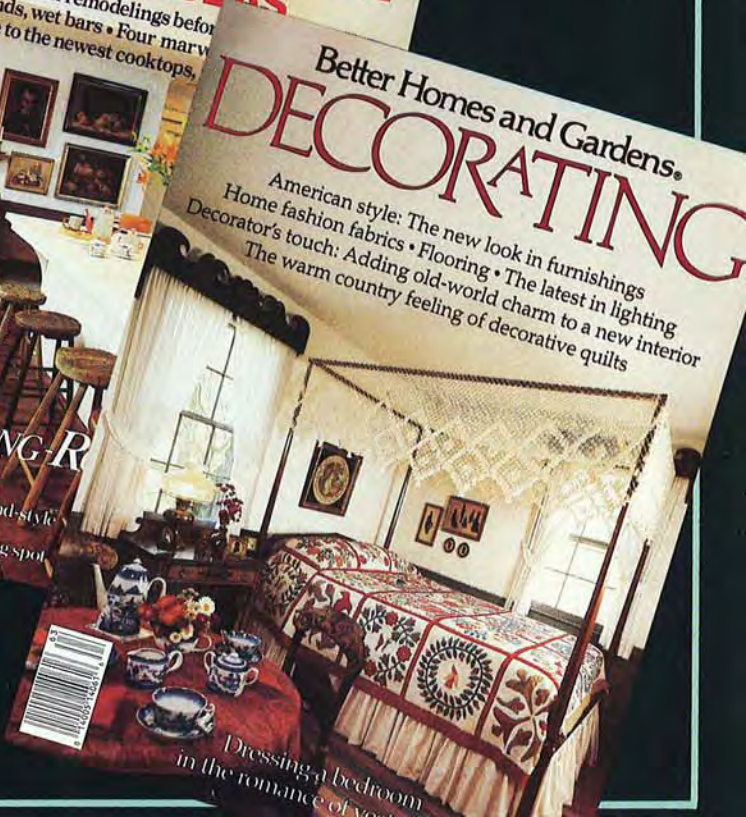

DECORATING
American style: The new look in furnishings
Home fashion fabrics • Flooring • The latest in lighting
Decorator's touch: Adding old-world charm to a new interior
The warm country feeling of decorative quilts

**Better Homes and Gardens®
Special Interest Publications
At Your Newsstand Now!**

OUR PORTABLE PLANER IS THE WALKAWAY FAVORITE.

When we say our tools are built for the real world, it's more than just a snappy advertising slogan. It means we design tools to be used by demanding professionals. Then manufacture them to withstand demanding working conditions.

Our AP-10 Portable Planer is a good example. We made it small enough to use in even the most cramped of workshops: it weighs just 58 lbs. and takes up less than four square feet of space.

But we didn't stop there. We gave the AP-10 the capacity to plane material up to 10" wide and 5" thick. And built it tough enough to do it day in and day out.

The power tool buyers of America responded by making the AP-10 one of the most successful new products of 1986. This year, we expect even more professionals and serious do-it-yourselfers to walk away with an AP-10.

If you live and work in the real world, you owe it to yourself to take a close look at the AP-10 Portable Planer. You'll find it alongside the complete Ryobi line, wherever professional power tools are sold.

 **RYOBI**
Built for the real world.™
Bensenville, IL 60106
312-766-1621

