

Better Homes and Gardens®

WOOD

SPECIAL
HOLIDAY GIFTS
EDITION

THE MAGAZINE FOR HOME WOODWORKERS

\$3.50

December 1985 • ISSUE NO. 8
Display Until December 19

HOW TO BEND LAMINATED WOOD

It's easier than you think! Step-by-step, plus 2 great plans

WHAT'S NEW IN SCROLL SAWS

Complete buying guide, page 54

ROUTER BITS

How your choices shape up

PROJECT PLANS

Old-time sled
Bentwood coat-tree
Woodworker's mallets
Laminated desk set
Snack tray
Toy jeep
And much more . . .



**GIFTS
GALORE!**

**8 BRIGHT NEW IDEAS FOR
HOLIDAY GIVING (See page 62)**



0

What price perfection?



Half price. While supplies last.

The Delta 12" Variable Speed Wood Lathe.* It's turning out exquisite work in professional shops across the country. Now, while we're still celebrating the return of our Delta name, it could turn up in your home shop, for just \$1399. (Suggested retail—\$2529.)

And, as if that weren't enough, we'll even treat you to an accessory package worth \$242. That's a total value of \$2771 for \$1399. Not quite half price. But pretty darn close.

That includes our new Super Chuck for face plate turning, eight turning tools... and two "how-to" books to sharpen your skills.

You'll celebrate too when you experience just a few of the features of this professional quality lathe. A big, cast-iron bed for stability and capacity. A smooth variable speed drive that locks in anywhere from 340 to 3600 rpm. A powerful, reliable ¾ h.p. motor.

Buy it, and you'll turn out your best work.

Buy it *now*, and we'll turn in our best price.

Call toll-free for the name of your participating Delta distributor: Delta International Machinery Corp., 800/438-2486 (in PA, 800/438-2487).

Offer good only on sales in the continental U.S., Alaska and Hawaii.

*Model #46-541S

DELTA

Behind Our New Name Is Our Old Reputation.



BOUGHT vs. BUILT.

When a child asks for a sleek new snow sled, there's two ways to make his dream come true. You can go to the store and buy one, or you can take some time and a bit of wood and build him one.

Millions have discovered that hand-built is better than store-bought, in so many ways. And once you start enjoying the rewards of woodworking, we think you'll agree.

There's no comparison.

Any child would be happy with the sled on the left. But the store-bought version has its drawbacks.

First of all, it's not nearly as durable as our all-wooden flyer. Most mass-produced goods just aren't made to last like hand-built originals. And if one of the parts breaks or gets lost, chances are you're not going to be able to fix it very easily.

On the other hand, the sled on the right will last a lifetime because you build every inch of it with durable wood you select yourself. And if it does need a little repair over the years, you can do it because it's made with wood. And the price? You can build our custom-built sleigh right down to the wooden runners and cherry inlay — for less than half the cost of store-bought!

Combine these benefits with the satisfaction of creating something unique with your own two hands, and you get far more for your time and money when you do-it-yourself.

Build it right, build it for less, with Shopsmith.[®]

Making things for loved ones, instead of just buying them, is one of the many accomplishments you can enjoy when working with wood. You can also custom-build furniture, bookshelves or other furnishings to suit your lifestyle and fit your home. Or, with a little experience, you can build exact replicas of classic antiques you might never be able to afford otherwise. And Shopsmith can help you do it right with woodworking tools that are made for the job.

Take the MARK V, for instance. A remarkable woodworking "system," it combines the five most-needed power tools in one compact, space-saving unit. You get a 10" table saw, 16½" vertical drill press, 12" disc sander, 34" lathe and horizontal borer. Together, this versatile "shop full of tools" can save you time and money on the simplest or most complex projects.

And you don't have to be a woodworking expert. The MARK V is easy to operate. So you can start building the projects you want the day you roll it into your shop!

Shopsmith gives you more for your woodworking investment.

Shopsmith is always ready to help you expand your woodworking capabilities with a full line of products and accessories. You can shop by mail, by phone, at one of our Shopsmith stores, or when you attend a Free Shopsmith demonstration in your area.

But quality tools and woodworking products are only part of the Shopsmith story. Informative classes and seminars, taught by woodworking experts, are available to improve your woodworking skills. There are magazines and catalogs to keep you up on what's happening in woodworking. Shopsmith even has a Service Hotline you can call when you have a question or a woodworking problem.

It's all part of the Shopsmith Difference. And that's the best reason of all to make Shopsmith your woodworking company.

Free Information Kit and magazine subscription!

Send in the coupon below and receive a Free MARK V information kit, including a copy of "How To Determine Your Best Power Tool Buy." Act now and you'll also receive a Free one-year subscription to "Hands On," the famous Home Workshop Magazine.

Call Toll-Free 1-800-228-2202
In Nebraska — 1-800-642-8788



© Shopsmith, Inc. 1985
Shopsmith® is a registered trademark of Shopsmith, Inc.
Available in the U.S.A. and Canada only.

Please send me a Free MARK V Information Kit including the informative booklet, "How To Determine Your Best Power Tool Buy," and start my Free one-year subscription to "Hands On." I understand I am under no obligation.

Name _____

Address _____

City _____

State _____ Zip _____

I currently own a Shopsmith woodworking power tool.



Shopsmith Inc.

For better woodworkers
And those who want to be
6640 Poe Avenue
Dayton, OH 45414-2591

Dept. 376M

FREE SANDING BELTS

DIRECT FROM THE MANUFACTURER

GET SIX FREE BELTS FOR EACH DOZEN ORDERED. All belts are aluminum oxide first quality. Our electronic presses make smooth bump-free splices.

Check your size and how many dozen. We will ship assorted grits unless otherwise specified.

- 1" x 30" — \$12.70/doz.
- 1" x 42" — 12.75/doz.
- 1" x 44" — 12.80/doz.
- 3" x 18" — 13.75/doz.
- 3" x 21" — 14.25/doz.
- 3" x 23 3/4" — 14.70/doz.
- 3" x 24" — 14.75/doz.
- 3" x 27" — 15.25/doz.
- 4" x 21 3/4" — 16.75/doz.
- 4" x 24" — 17.25/doz.
- 4" x 36" — 20.95/doz.
- 6" x 48" — 26.95/1/2 doz. (3 FREE)

Other size belts on request.

9" x 11" Paper Sheets

A/O Cabinet Paper

- | | |
|--|-----------------------------------|
| 50/pk. | 100/pk. |
| 40-D <input type="checkbox"/> \$17/pk. | <input type="checkbox"/> \$31/pk. |
| 50-D <input type="checkbox"/> 16/pk. | <input type="checkbox"/> 28/pk. |
| 60-D <input type="checkbox"/> 15/pk. | <input type="checkbox"/> 26/pk. |
| 80-D <input type="checkbox"/> 14/pk. | <input type="checkbox"/> 24/pk. |
| 100-C <input type="checkbox"/> 13/pk. | <input type="checkbox"/> 22/pk. |
| 120-C <input type="checkbox"/> 13/pk. | <input type="checkbox"/> 22/pk. |
| 150-C <input type="checkbox"/> 13/pk. | <input type="checkbox"/> 22/pk. |

No Load Finishing Paper

- | | |
|---|-----------------------------------|
| 50/pk. | 100/pk. |
| 180-A <input type="checkbox"/> \$11/pk. | <input type="checkbox"/> \$19/pk. |
| 220-A <input type="checkbox"/> 11/pk. | <input type="checkbox"/> 19/pk. |
| 280-A <input type="checkbox"/> 11/pk. | <input type="checkbox"/> 19/pk. |
| 320-A <input type="checkbox"/> 11/pk. | <input type="checkbox"/> 19/pk. |
| 400-A <input type="checkbox"/> 11/pk. | <input type="checkbox"/> 19/pk. |

Wet or Dry S/C Paper

- | | |
|---|-----------------------------------|
| 50/pk. | 100/pk. |
| 220-A <input type="checkbox"/> \$15/pk. | <input type="checkbox"/> \$25/pk. |
| 320-A <input type="checkbox"/> 15/pk. | <input type="checkbox"/> 25/pk. |
| 400-A <input type="checkbox"/> 15/pk. | <input type="checkbox"/> 25/pk. |
| 600-A <input type="checkbox"/> 15/pk. | <input type="checkbox"/> 25/pk. |

NEW ITEM!

- BELT CLEANING STICK - \$6.95

Prompt delivery from stock.
MONEY-BACK GUARANTEE

Shipping Charges - Under \$35 add \$2.50; \$35 or more add \$4.00—PA residents add 6% sales tax.

- Check or Money Order.
- MasterCard VISA Exp. Date _____
- Acct. # _____
- Name _____
- Address _____
- City, State & Zip _____

CALL TOLL FREE

1-800-428-2222

PA Only - 1-800-222-2292

INDUSTRIAL ABRASIVES CO.

643 North Eighth Street
Reading, PA 19603

Better Homes and Gardens®

WOOD

THE MAGAZINE FOR HOME WOODWORKERS

December 1985 Issue No. 8

Editorial/Art Staff

Editor **LARRY CLAYTON**
 Managing Editor **DAN KAERCHER**
 Art Director **C.L. GATZKE**
 Design Editor **JAMES R. DOWNING**
 Features Editor **PETER J. STEPHANO**
 How-To Editor **MARLEN KEMMET**
 Project Builder **JAMES E. BOELLING**
 Graphic Designer **PERRY A. McFARLIN**
 Administrative Assistant **DARLENE REYNOLDS**

Technical Consultants: **GEORGE GRANSETH** Product Testing; **VERNON U. WARD** Collectible Tools; **PAUL L. McCLURE** Wood Technology

Editorial Director **DORIS M. EBY**
 Publishing Director **ADOLPH AUERBACHER**

Editorial Services

Executive Director **DUANE L. GREGG**
 Director, Editorial Research **C. RAY DEATON**
 Administrative Editor **ROSE ANDERSON**

Publisher **JERRY KAPLAN**
 Promotion/Research Director **THOMAS J. TROLAND**
 Circulation Director **WILLIAM HUMMEL**
 Production Director **DALE SCHENKELBERG**

Publishing Group Officers

President **JACK D. REHM**
 Senior Vice Presidents
 General Manager,
 Magazines **JAMES A. AUTRY**
 General Manager,
 Books and Newspapers **FRED STINES**
 Group Vice President
 Editorial Director **DORIS M. EBY**

Corporate Officers

Chairman of the Board **E. T. MEREDITH III**
 President **ROBERT A. BURNETT**
 Group Presidents: Publishing **JACK D. REHM**; Broadcasting **W. C. McREYNOLDS**; Real Estate **ALLEN L. SABBAG**
 Senior Vice President **JAMES CONLEY**
 Vice Presidents: Corporate Relations **DONALD L. ARNOLD**; General Counsel and Assistant Secretary **THOMAS G. FISHER**; Product Development **NEIL KUEHN**; Corporate Planning **HERB SCHULTE**; Finance **WILLIAM H. STRAW**; Administrative Services **GERALD D. THORNTON**
 Secretary **BETTY CAMPBELL MADDEN**
 Treasurer **MICHAEL A. SELL**
 Controller **LARRY D. HARTSOOK**

Better Homes and Gardens® WOOD — the magazine for home woodworkers (ISSN-0743-894X) is published bimonthly in February, April, June, August, October, and December by Meredith Corporation, 1716 Locust Street, Des Moines, IA 50336. Second-class postage paid at Des Moines, Iowa. Trade-mark registered in Canada and Australia. Marca Registrada en Mexico. **SUBSCRIPTION PRICES:** One year \$15 in the United States and its possessions. Canada and other countries add \$6 per year. **POSTMASTER:** Send address changes to WOOD, 1716 Locust Street, Des Moines, IA 50336. December 1985, No. 8. **CUSTOMER SERVICE:** For service on your magazine subscriptions, including change of address, write to Customer Service Manager **ROBERT AUSTIN**, P.O. Box 10628, Des Moines, IA 50336. Please enclose a recent address label. ©COPYRIGHT MEREDITH CORPORATION 1985. ALL RIGHTS RESERVED. PRINTED IN U.S.A.

DALCRAFT'S 1985 Furniture Design Catalog provides a source for hard to find **FULL-SIZE PLANS** ■ Designs include Gun Cabinets ■ Cradles ■ China Cabinets ■ Swivel Chair & Popular **ROLL TOP DESK** ■ Over 270 Projects! Featuring Early American ■ Spanish ■ Modern and newly added **QUEEN ANNE** style groupings ■ Also Decorative Hardware to compliment Dalcraft designs ■ in each category you'll find Family room ■ Dining room ■ Bedroom and Decorative Accent plans ■ Blueprints are **Full-SIZE** with Bill of Materials and sources for hard-to-find hardware items ■ perspective and exploded view drawings

- \$1.00 (3rd Class)
- \$2.00 (1st Class)

Refunded with first order.

Send To

DALCRAFT, INC.

DEPT. GW-11/5, P.O. BOX 746, STARKVILLE, MS 39759

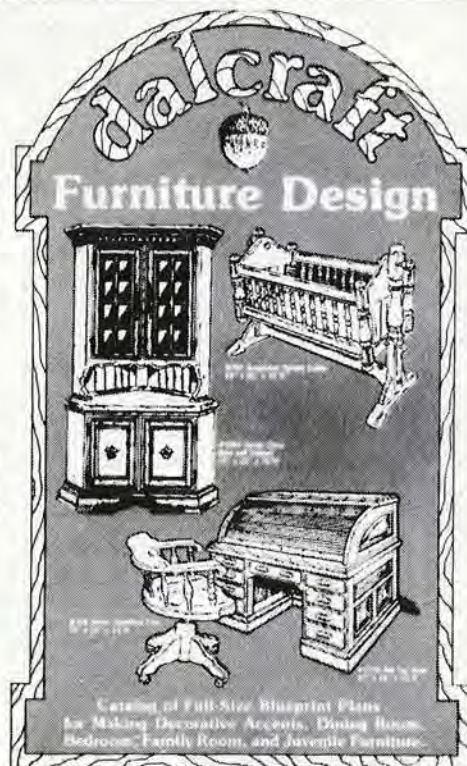

Phone 601-324-1314

Christmas Time

EMPEROR'S

NEWPORT

DO-IT-YOURSELF CASE KIT MODEL 120-K

SOLID 3/4" BLACK WALNUT

\$139.50 FACTORY DIRECT SALE PRICE WITH PURCHASE OF MOVEMENT
 Kit Without Movement \$159.50
 Regular Factory Direct Price \$239.50

When completed, compare this beautiful grandfather clock at \$1,000 and more retail!

A GRANDFATHER CLOCK FOR CHRISTMAS!

Emperor's Newport Model 120-K grandfather clock makes the *perfect* Christmas gift. A long-time favorite, its timeless, classic design is beautifully executed in solid 3/4" American black walnut. Emperor Clock Company can offer this flawless beauty and excellent craftsmanship at the very *best* price because we sell factory direct. No expensive middleman is involved and the savings are passed on to our customers.

EMPEROR'S KITS ARE EASY TO ASSEMBLE

You will enjoy every minute you spend building your Newport Model 120-K. No woodworking experience is necessary. All parts are pre-cut, then sanded smooth on both sides. Difficult parts are pre-assembled. Easy-to-follow instructions are included, along with screws and hardware. Glass is not included due to possible breakage in shipment.

EMPEROR MOVEMENTS AND DIALS

Emperor movements and dial faces are manufactured in West Germany and carry a three-year warranty. The movement features a self-regulating escapement, which means it adjusts so *you never have to level your clock*. Each movement is made of solid brass with pinions of hardened steel and comes complete with weights, solid brass weight shells, brass-finished bob, lyre pendulum and chimes. The chimes consist of two sets of musically tuned rods. One set sounds the historic Westminster chimes. The other set counts the hour with a Big Ben tone.

Choose from two dial versions: Tempus Fugit (Time Flies) and Moving Moon with classic lunar calendar. Each dial is made of *solid* brass with black Roman numerals; however, for an additional \$20, either dial is available with raised Arabic numerals.

All Emperor movements are thoroughly inspected and tested before being shipped to you. If for any reason you are not completely satisfied, return in original shipping carton within thirty days for prompt refund. No questions. No excuses.

**MAIL YOUR CHRISTMAS ORDER TODAY!
 SALE ENDS DECEMBER 31, 1985**

Order Direct With This Form • Orders Shipped 2 To 3 Weeks • Shipping Charges Collect
EMPEROR CLOCK COMPANY, Dept. 127 Please Check:
 Emperor Industrial Park, New Customer
 Fairhope, Alabama 36532 Previous Customer
CREDIT CARD TELEPHONE ORDERS WELCOME
 CALL 1-205-928-2316

NAME _____
 STREET _____
 CITY, STATE, ZIP _____
 TELEPHONE NUMBER _____ (PLEASE PRINT)

QTY.	PRODUCT NUMBER	DESCRIPTION	WT.	REG. PRICE	SALE	EXTENSION
	#104	Newport Model 120-K, Solid 3/4" Black Walnut Do-It-Yourself Case Kit (With Purchase of Movement Priced Separately Below)	50	\$239.50	\$139.50	
	#104	As Above, Without Purchase of Movement	50	\$239.50	\$159.50	
	#201	Model 101-M Self-Adjusting Movement Complete with Westminster Chimes, Moving Moon Dial, Roman Numerals for Model 120-K	30	\$174.50		
	#202	As Above, with Raised Arabic Numerals	30	\$194.50		
	#206	Model 101-M Self-Adjusting Movement Complete with Westminster Chimes, Tempus Fugit Dial, Roman Numerals for Model 120-K	30	\$159.50		
	#207	As Above, with Raised Arabic Numerals	30	\$179.50		

Enclosed \$ _____ Check

Charge to my: MasterCard VISA
 Diners Club American Express

TOTAL \$ _____
 Alabama residents, add 4% sales tax;
 CA, GA, NC, TN, WI residents, add
 applicable sales tax \$ _____

Card No. _____ Expires _____ GRAND TOTAL \$ _____

FREE!
Lyre Pendulum
 With Purchase of Kit and Movement.

NEWPORT MODEL 120-K
 Solid 3/4" Black Walnut
 74"(H) x 16 1/2"(W) x 10"(D)



**EMPEROR®
 CLOCK COMPANY**
 WORLD'S LARGEST MANUFACTURER
 OF GRANDFATHER CLOCKS
 © 1985 Emperor Clock Company
 All Rights Reserved

Please ship this order: UPS
 Parcel Post Motor Freight
 Emperor reserves the right to select
 method of shipment, if necessary.

**NOW!
REDUCE THE
RISK AT YOUR
TABLE SAW**



folds down neatly

WITH THE **MOBILE™**
NEW **SAWING CENTER**

OUTFEED ROLLERS

- safe, accurate sawing
- handle panels with ease
- available in 15" and 37" widths
- dual-position table

AND INCREASE FLOOR SPACE



MOBILE MACHINE BASES

- increase shop working area
- maximize usable floor space
- 3 point base will not rock
- locking wheels
- makes machine so easy to use and store
- over 80 standard models

PLANER STAND WITH ROLLERS

- raises planer to proper working height
- provides machine mobility
- five-fold increase in workpiece support
- storage is a snap



NEW



- ROLLERTABLE
Rock Solid Support**
- adjustable
 - portable
 - use at any machine

PEDESTAL
ROLLER

Discover HTC's many unique products designed only with you, the dedicated woodworker in mind. Find out how you can make your machining safer, increase working area of your shop and accomplish nearly impossible tasks easily, quickly and accurately - **all by yourself!**

CALL TODAY!

HTC PRODUCTS, INC.
120 E. HUDSON S-8
ROYAL OAK, MI 48067
(313) 399-6185



1-800-624-2027 ext. 112

Better Homes and Gardens®

WOOD

THE MAGAZINE FOR HOME WOODWORKERS

DECEMBER 1985

ISSUE NO. 8

WOOD PROFILE

PECAN: THE 'GREAT SPIRIT' HICKORY 29

This prolific member of the hickory family, once revered by the Indians, combines remarkable strength, elasticity, and beauty.

CRAFTSMAN CLOSE-UP

**A RENAISSANCE FOR 30
HANDCRAFTED PSALTERIES**

The ethereal tones of the bowed psaltery have captivated listeners since the Renaissance. Now, a trio of Florida woodworkers has sparked renewed interest in this fascinating instrument—a delight to both the eye and ear.



HOMEMADE TOOL

**HARD MAPLE WOODWORKER'S 34
MALLETS**

Skilled woodworkers count a wooden mallet among their most trusted tools. Our designs feature large, leather-protected striking surfaces.



SHOP-TESTED TECHNIQUES

**HOW TO BEND LAMINATED 36
WOOD**

Ready to break out of the mold and do some extraordinary things with wood? Here's how to laminate thin strips into truly distinctive curved designs.



NOW YOU CAN BUILD IT

OAK COAT-TREE 42

You won't find a better test project for our bentwood lamination technique than this coat-tree, with its curved uprights of resawn oak strips. Save the forms and make several.



JUST LIKE GRANDDAD'S!

BENTWOOD SLED 44

Build this young-at-heart heirloom and you're sure to light up a youngster's heart. The laminated runners and supports make this sled amazingly strong, yet lightweight.



BUYMANSHIP BASICS

ROUTER BITS: HOW YOUR CHOICES SHAPE UP 50

Bit by bit, your router bit inventory builds until it's worth more than your router. Here's how to sort out all those types of bits and what they do.



TOOL BUYMANSHIP

THE NEW CONSTANT-TENSION SCROLL SAWS 54

No time for a scroll saw in your shop? You may change your mind after you read about the latest models and features.



BUYMANSHIP BASICS

EPOXY: THE "TOUGH GUY" GLUE MOST WOODWORKERS NEVER USE 60

If you haven't tested epoxy in your shop, it's high time you give it a try. This amazing adhesive, long popular with boaters, offers exceptional strength and moisture-resistance.

PEOPLE-PLEASING HOLIDAY GIFTS

ZEBRAWOOD SNACK TRAY 62

Serve up this great gift and we guarantee you'll make a hit with somebody special.



JIM-DANDY JEEP 64

Any pint-sized mechanic will love assembling and disassembling this take-apart toy.

NEW HORIZON DESK SET 66

One lamination yields enough of the laminated wood design for two handsome desk sets.



THE 3 CHARM BEARS 70

We think you'll be totally "charmed" by these kids' room specials.



JUST FOR HER' NECKLACE 71

This classy hardwood necklace will delight her and showcase your woodworking skill at the same time.



DESERT DAYBREAK WALL HANGING 72

A palette of thin-sawn woods captures a striking scene. It's a special gift someone in your life will treasure for years to come.



SHORT-SUBJECT FEATURES

Editor's Angle	7	Circuiting for Safety	82
Talking Back	8	Wood Anecdote	91
Tips from Your Shop (And Ours)	10	Associations	93
Products that Perform	18	Magazine Customer Service Information	94
Project Showcase	52	Bulletin Board	104
		The Christmas Wagon	78

Woodworkers' Hardware ORDER FORM

Qty.		Total
	Black Hammer Hinge \$2.70/2 \$1.62/2 \$11.95/10 \$7.17/10 Screw for Above \$4.96/C \$2.97/C	
	Birch Mug Peg \$.43/ea. \$.26/ea.	
	Birch Shaker Peg \$.47/ea. \$.28/ea.	
	Birch Furniture Spindles 6 inch \$1.70/ea. \$.42/ea. 8 1/2 inch \$1.20/ea. \$.72/ea.	
	#S4 Galley Spindle Birch \$.28/ea. \$.17/ea. Oak \$.35/ea. \$.21/ea.	
	#S5 Galley Spindle Birch \$.41/ea. \$.25/ea.	
	Wood 7/8" \$7.80/C \$4.80/C 1" \$11.68/C \$6.95/C 1 1/4" \$15.00/C \$9.00/C 1 1/2" \$18.35/C \$11.01/C 1 3/4" \$26.00/C \$15.60/C Wheels 2" \$32.60/C \$19.50/C	
	#AP1 Axle Peg Fits 1" to 2" Wheel \$6.95/C \$4.17/C	
	Brass Plated Flat Head Wood Screws (3/8" x #2) \$4.12/C \$2.50/C (1/2" x #2) \$4.28/C \$2.57/C (1/2" x #4) \$4.40/C \$2.64/C (1/2" x #5) \$5.93/C \$3.02/C (3/4" x #7) \$5.27/C \$3.16/C	
	Screw Hole Buttons 3/8" \$3.93/C \$1.82/C 1/2" \$3.23/C \$1.94/C	
	Dowel Pins 3/8" x 2" \$3.98/C \$1.85/C	
	Saw Tooth Hangers \$6.95/C \$4.17/C	
	Brass Plt. Picture Hanger \$7.95/C \$4.77/C	
	Clock Movements w/Hands Q82 \$70.62/ea. \$6.37/ea. \$49.50/5 \$29.70/5 5" Clock Dial — White Plastic \$2.50/ea. \$1.50/ea.	
	Lazy Susan Bearing 3" \$1.15/ea. \$.69/ea. 4" \$1.60/ea. \$.96/ea. 6" \$2.80/ea. \$1.73/ea.	
	Brass Plated Candle Cup \$5.60/10 \$3.00/10 \$49.00/C \$29.40/C	
	Two Prong, 6" Brass & Porcelain Hook \$4.95/ea. \$2.97/ea. \$45.00/10 \$27.00/10	
	Three Prong, 6" Brass & Porcelain Hook \$8.25/ea. \$4.95/ea. \$29.99/4 \$18.00/4	
	Jiggle Eyes (1/4") \$2.45/C \$1.47/C (1/2") \$3.45/C \$2.07/C (4/5") \$6.86/C \$4.11/C	
	Disk Magnets \$2.98/6 \$1.79/6	

Note: C = 100

Catalog \$1.00 or free with order Total Order

Minimum Order is \$25.00 MN Res. - 6% Tax

Order Amount: Shipping: Shipping:

\$25.00 to \$49.99 \$3.50 Total Enclosed

\$50.00 to \$99.99 \$4.50

Over \$100.00 \$5.00 Visa Master Card

MONEY BACK GUARANTEE! Alaska, Hawaii, Canada & APO Orders Add \$6.00 VISA MasterCard

SIGNATURE _____

CARD NO _____ EXP DATE _____

NAME _____

ADDRESS _____ CITY _____

STATE _____ ZIP _____ PHONE () _____

MEISEL HARDWARE SPECIALTIES
PO Box 258W12, Mound, Minnesota 55364 • (612) 472-5544

freud[®] CHISEL, TURNING, AND CARVING SETS

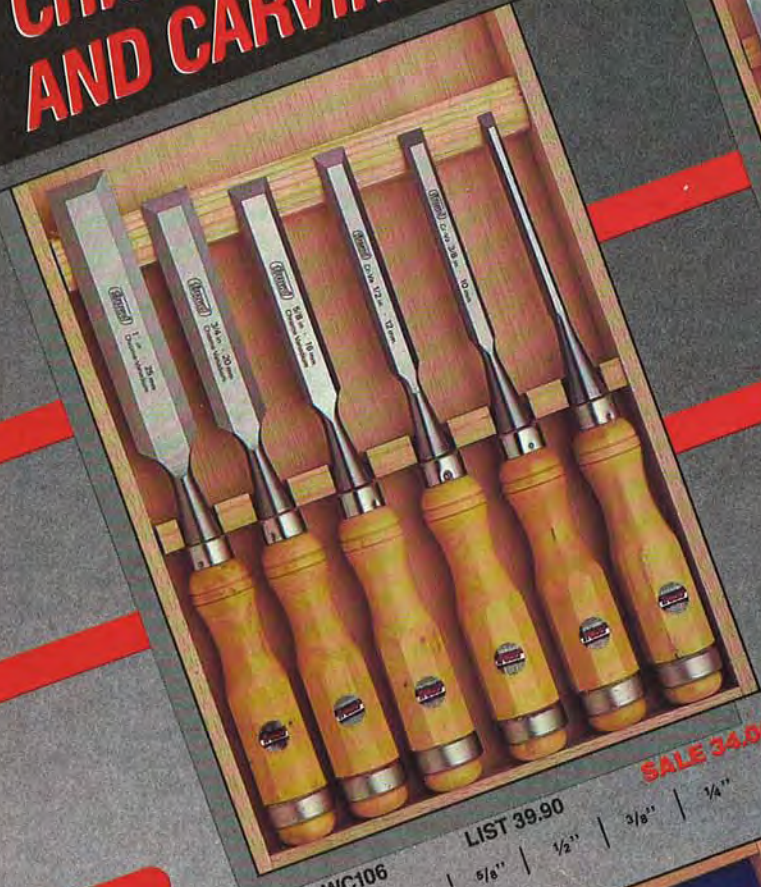

ITEM WC106 LIST 39.90 SALE 34.00
1" | 3/4" | 5/8" | 1/2" | 3/8" | 1/4"



ITEM TT108 LIST 67.90 SALE 57.00
Turning Tools, TT108 (shown above), Set Includes:
1/2" Diamond Point, 1/2" Round Nose, 1/2" Parting Tool,
1/2" Skew, 1" Skew, 1/4" Gouge, 5/8" Gouge, 7/8" Gouge



ITEM CS112 LIST 139.90 SALE 118.00
3/8" Straight Chisel
3/8" Skew Chisel
1/4" Flat Gouge
5/16" Gouge
3/16" Spoon Gouge
1/2" Gouge
1/4" Gouge
3/16" Gouge
3/8" Gouge
3/8" Gouge
1/4" Parting Tool

**Now At Sale Prices Until
December 31, 1985.**

These Freud handtools are made of premium chrome vanadium steel to insure that our customers get the most tool for their money. The wooden handles are of selected close-grained boxwood on the chisel and carving sets. The traditional ash is used on the turning tool handles. Each is a mark of proven craftsmanship. Each set is conveniently packaged in a fitted, box-jointed wooden case for your ease of organization and storage. Contact your local Freud distributor today to take advantage of this valuable price savings.

Call Us Toll Free!

FOR THE NAME OF YOUR LOCAL DISTRIBUTOR:

- In California Call Toll Free: 1-800-824-0141
- If You Live In This Area: 1-800-824-8045
- If You Live In This Area Call Toll Free (Outside NC): 1-800-334-4107

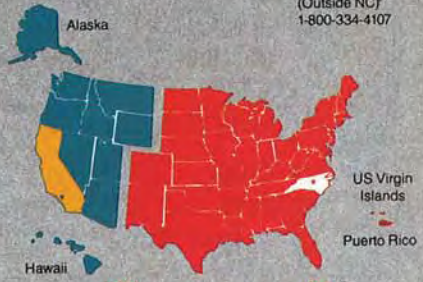

freud[®]

218 Feld Ave., High Point, NC 27264 (919) 434-3171
1570 Corporate Dr., Suite G Costa Mesa, Cal. 92626 (714) 751-8866

THE EDITOR'S ANGLE

We do more than stand behind our product; we stand on it!



WOOD magazine sledding enthusiasts (from left): Jim Downing, me, and Marlen Kemmet—596 lbs. total.

A funny thing happened the other day on the way to the coffee pot. I spotted Design Editor Jim Downing (that's him wearing the scarf in the photo) jumping up and down on the sled shown above. One of the other staffers, I found out later, had asked Jim if the sled would hold together if someone actually used it, so Jim went into his Jumping-Jack routine to emphasize his point.

That short episode started me thinking about the many woodworkers I've met, and how almost every one of them has displayed the same enthusiasm about their hobby and pride in their product as Jim did. That's refreshing, especially today when it seems that so many people think that "pretty good is good enough."

Speaking of a quality product, I'm particularly proud of this holiday 1985 issue of *WOOD*. There's a fact-filled article on epoxy glue (the stuff we put the sled together with), lots of holiday gift ideas (we know you're busy, so we kept them quick to build), a six-page article on scroll saws, and another on bending laminated wood, plus all our regular features. Here's hoping you find some enjoyable reading along the way.











On behalf of the entire *WOOD* magazine staff, I'd like to wish you the happiest of holidays and a healthy, happy 1986.

Larry Clayton

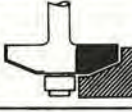

CARBIDE TIPPED ROUTER BITS PROFESSIONAL PRODUCTION QUALITY SPECIAL OFFER — SAVE 50% - 75% BELOW COST

1000's SOLD TO READERS OF FINE WOODWORKING

BEST CUT BEST PRICE	ITEM NO.	DESCRIPTION	RADIUS	LARGE DIAM.	CUTTING LENGTH	PRICE
	COVE					
	#01	1/4" R	1/4"	1"	1/2"	\$13.00
	#02	3/8" R	3/8"	1 1/4"	9/16"	14.00
	#03	1/2" R	1/2"	1 1/2"	5/8"	15.00
	ROUND OVER					
	#04	1/4" R	1/4"	1"	1/2"	15.00
	#05	3/8" R	3/8"	1 1/4"	5/8"	16.00
	#06	1/2" R	1/2"	1 1/2"	3/4"	19.00
	ROMAN OGEE					
	#07	5/32" R	5/32"	1 1/4"	15/32"	18.00
	#08	1/4" R	1/4"	1 1/2"	3/4"	20.00
	#11	3/8" RABBETING	Deep 3/8"	1 1/4"	1/2"	14.00
	#09	1/8" (KERF) SLOT CUTTER		1 1/4"	1/8"	14.00
	#10	1/4" (KERF) SLOT CUTTER		1 1/4"	1/4"	14.00
	#12	45° CHAMFER	45° Angle	1 1/2"	5/8"	15.00
	#15	RAISED PANEL	20° Angle	1-5/8"	1/2"	25.00
	DOVETAIL BITS					
	#16	3/8" DOVETAIL	9°	3/8"	3/8"	7.50
	#17	1/2" DOVETAIL	14°	1/2"	1/2"	8.50
	#18	3/4" DOVETAIL	14°	3/4"	7/8"	10.50
	CORE BOX (ROUND NOSE)					
	#19	3/8" CORE BOX	3/16"	3/8"	3/8"	11.00
	#20	1/2" CORE BOX	1/4"	1/2"	11/32"	14.00
	#21	3/4" CORE BOX	3/8"	3/4"	5/8"	18.00
	GROOVE FORMING OGEE					
	#22	1/2" GROOVING OGEE		1/2"	3/8"	16.50
	#23	3/4" GROOVING OGEE		3/4"	7/16"	21.00
	#24	1/4" Straight Bit	1/4"	1"	7.00	
	#25	5/16" Straight Bit	5/16"	1"	7.00	
	#26	3/8" Straight Bit	3/8"	1"	7.00	
	#27	1/2" Straight Bit	1/2"	1"	7.00	
	#28	3/4" Straight Bit	3/4"	1"	10.50	
	Flush Trim					
	#13	1/2" FLUSH TRIM		1/2"	1"	8.50
	Key Hole					
	#14	3/8" KEY HOLE (This Bit only HSS)	CUTS 3/8" KEY HOLE FOR FLUSH MOUNTING PICTURE FRAMES, ETC.		8.50	

WHEN ORDERING ANY 3 OR MORE, DEDUCT \$1.00 EACH
ALL PRICES POSTAGE PAID

- Professional Production Quality • 1/2" Ball Bearing Pilot
- 1/4" Diameter Shanks x 1 1/4" Long • One Piece Construction
- Two Flute Thick High Quality Tungsten Carbide Tips

To order by Master Charge or Visa Toll Free
7 Day — 24 Hour Order Service Call

1-800-523-2445 Ext. 56 (in PA 1-800-346-7511 Ext. 56)
or send check to: **MLCS, Box 53D, Rydal, PA 19046**

NOW! Get in on the PROFITS in

SMALL ENGINE REPAIR!



Start your own money making business!

Work part time, full time—right at home—we help you every step of the way.

No doubt about it... as a small engine pro, you can cash in on the huge demand for qualified men in one of America's fastest growing industries. You'll be able to command top hourly rates of from \$25.00 to \$30.00 per hour—and that's just for labor. A simple tune-up earns as much as \$49.95 for less than an hours work, and parts, engines and accessories will add even more to the profits.

Plenty of business waiting for qualified men.

65,000,000 Small Engines Are In Use Today!

That's the official count from the Engine Service Assn., and one-million new engines are being built each month. With fully accredited Foley-Belsaw training, you can soon have the skills and knowledge to make top money servicing these engines. People will seek you out and pay you well to service their lawnmowers, tillers, edgers, power rakes, garden tractors, chain saws, minibikes, snowmobiles, generators, go-carts, paint sprayers, snowblowers... the list is almost endless.



Professional Tools and Equipment, PLUS 4 H.P. Engine ALL YOURS TO KEEP... All at No Extra Cost.

NO EXPERIENCE NECESSARY!

You don't need to be a 'born mechanic' or have any prior experience. You can master this profitable trade right at home in your sparetime. Lessons are fully illustrated...so clear you can't go wrong, and with our famous 'learn-by-doing' method you get practical 'hands-on' experience. We also show you how to get business, what to charge, where to get supplies wholesale...all the inside tricks of the trade you need to assure success right from the start.

Send for FREE Facts—Do It TODAY!

NO Obligation—NO Salesman Calls!

You risk nothing by accepting this offer to see how easily you can learn the skills you need to increase your income in a high-profit business of your own. Just fill in and mail coupon below (or send postcard with name and address) to receive full information by return mail.

RUSH COUPON TODAY

Foley-Belsaw Institute
50766 Field Building
Kansas City, MO 64111



FREE BOOKLET!

Send for your copy today!

FOLEY-BELSAW INSTITUTE
50766 FIELD BUILDING
KANSAS CITY, MO 64111



YES, please send me the FREE booklet that gives full details about starting my own business in Small Engine Repair. I understand there is No Obligation and that No Salesman will call on me.

NAME _____

ADDRESS _____

CITY _____

STATE _____

ZIP _____

TALKING BACK

Print this article

We welcome comments, criticisms, suggestions... even an occasional compliment from readers. While the volume of mail we receive makes it impossible to answer every letter, we publish excerpts in every issue of the magazine. Send your letters to:

Letters Editor
Better Homes and Gardens®
WOOD Magazine
1716 Locust Street
Des Moines, IA 50336

Dept. W, West Babylon, NY 11704.

CARD HOLDERS

On page 38 of the April, 1985 issue, the modular workbench group shows metal holders for tags to identify drawer contents above the drawer pulls. I'm unable to find them—please provide a source.

—Charles J. Hanrahan, Keene, N.H.

We bought our brass-finish card holders at a local hardware store.

You can order them from The Woodworkers' Store, 21801 Industrial Blvd., Dept. W, Rogers, MN 55374. Price: \$7.90, including postage and handling for a 10-pack (catalog #D3060, 1 1/2 x 2 1/4").

PANEL-RAISING SYSTEMS: LAST CALL

Yet another panel-raising router bit system has surfaced (see "Talking Back" on pages 12 and 19 of the October, 1985 issue). We want you to know about this one in particular because it performed beautifully in our shop, and the cost compares very favorably with other systems. Made in Taiwan, it's available from Furnima Industrial Carbide. Cost is \$103 U.S. (1/2" shank) or \$95 U.S. (3/8" shank). For further information, write Furnima at Bierknakie Road, Box 308, Dept. W, Barry's Bay, Ontario, Canada KOJ 1BO.

BEWARE OF TREE RUSTLERS!

Your short article on paulownia trees (WOOD, August, 1985, page 81) was very interesting. However, you should warn your readers that thefts of these beautiful trees have increased dramatically. As a police officer in central Maryland, I have seen many such incidents. My suggestion to honest people looking for this type of wood is to know your supplier. I don't think you'd want lumber that was taken from a neighbor's yard at 3 a.m.

—Allen Hafner, Catonsville, Md.



We've heard of a few walnut trees being pirated from farms in our part of the country, but we didn't realize that the problem extended to other species as well. A word to the wise...

SPRAY-ON VELVET LINING

Several readers have contacted WOOD wanting to know where they can obtain the spray-on drawer lining mentioned in the article about Richard Rothbard (August, 1985, page 26). You can purchase a "starter kit" containing brown and green fibers, adhesive, and a spray gun for \$41.50 (postage due on delivery). Write to: Donjer Products, 55 Alder St., Unit D,

COMING SOON: WOOD Q&A

Got a question about a wood-working problem? Need advice about finishing, joinery, wood species, power tools, or any of the hundreds of other subjects that make woodworking such a challenging and fascinating hobby? We invite you to drop a note to WOOD Reader Questions Column, WOOD Magazine, 1716 Locust St., Des Moines, IA 50336. We can't promise a personal reply to each letter, but we'll answer as many questions as we can. ■

If you love working with wood...

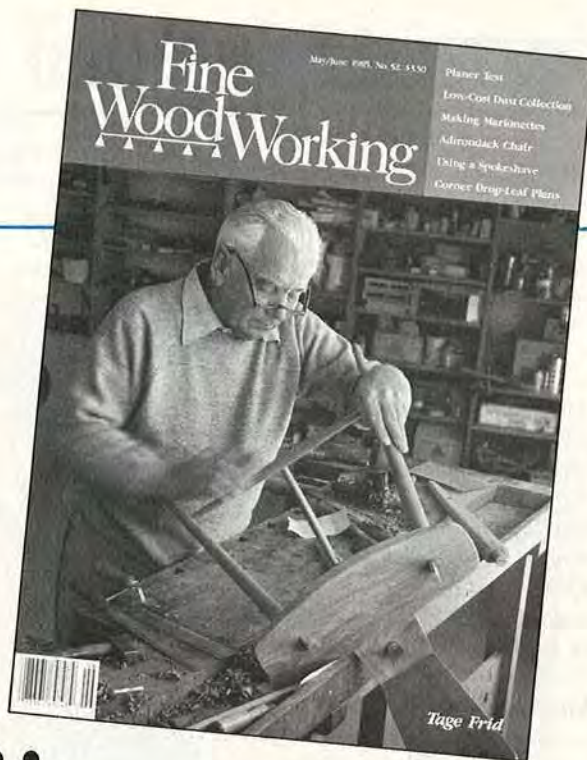

Fine Woodworking is the magazine you've been waiting for. A year's subscription gives you practical, hands-on information you can use on an incredible range of subjects—joinery, turning, carving, veneering, finishing, machines, handtools and any of a hundred other woodworking specialties.

All our articles are written by experienced woodworkers and well-known craftsmen who tell you what they do, how they do it and why. And every article comes complete with helpful, full-color drawings and photographs that take you in close so you can see what's going on. The result is everything a serious woodworker could ask for in a magazine: projects that teach new skills, demonstrations of tools and techniques, new design

ideas, old-world traditions, coverage of current woodworking events, and some breathtaking examples of the woodworker's art for inspiration.

What's more, we reserve at least one-quarter of each issue especially for our readers—a place where they can ask questions, air opinions and share jigs, tips, tricks and discoveries with each other.

If you'd like to join them, just fill out the coupon below and send for your subscription today. A year of *Fine Woodworking* (six issues) is just \$18, and as always, we guarantee your satisfaction.

For faster service, please use our toll-free number: **1-800-243-7252**.

Yes, I'd like to try *Fine Woodworking*.

Please send me the next issue and bill me just \$18 for a year's subscription—five more issues (\$21 in Canada, U.S. funds, please). If I'm not completely satisfied, I'll mark my bill 'cancelled' and owe nothing. (The issue is mine to keep.)

Name _____

Address _____

City _____ State _____ Zip _____

Bill me Payment enclosed MasterCard VISA Am. Ex.

Charge card # _____ Exp. date _____

Signature _____

Send to: **The Taunton Press, Box 355PWAC, Newtown, CT 06470**

In woodworking, as in life, no one knows it all. But through experience, we all discover—or stumble onto—better, safer, faster, or easier ways to do things. When we devise interesting tips or techniques, we'll share them with you in this column. And when you send us your favorites, we'll pay you \$25 for each submission we publish. No shop tips can be returned. Mail your tips to:

Shop Tips

Better Homes and Gardens® WOOD Magazine
Locust at 17th
Des Moines, IA 50336

Toothpick magic

Rarely can you find the right size small pieces of wood around your shop for the array of small gluing tasks.

TIP: Next time you're in the grocery store, pick up a box of flat toothpicks for your workshop—you'll be amazed at how helpful they can be.

A toothpick is handy for spreading glue and working glue into tight cracks. Toothpicks also make a world of difference when you glue them into loose screw holes. Fill a slightly off-centered screw hole with toothpicks and glue, allow to dry, and then drill a new screw hole on the edge of the original hole. These handy mini-timbers can also fill old nail holes in salvaged lumber; leave the ends long and sand smooth after the glue dries.

E. R. Huckleberry
Salt Lake City, Utah



A bevel on the level

The trick to cutting an accurate bevel on a long piece of stock is to keep the board flat against the surface of the table saw. If either end of the board raises off the table, the bevel will be uneven.

TIP: Attach a long, straight board to your fence. (Many fences have pre-drilled holes for this purpose.) Before gluing a piece of wood to the underside of the leading edge, be sure you can still use the fence-tightening knobs. This jig will help keep the stock aligned as it feeds into the saw. Use a roller support on the outfeed.

Tom Peters
Midland, Mich.

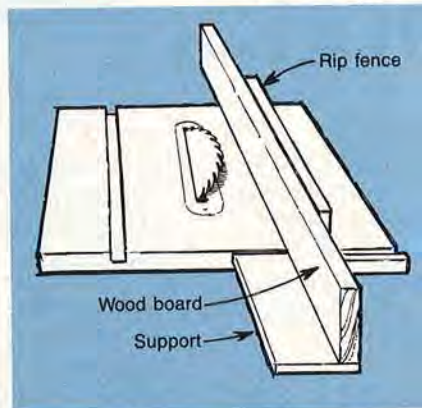

"Pencil pusher" safety tip

When mitering, scraps can linger too close to the blade, catch, and kick back.

TIP: The eraser end of a common pencil is a handy way to flick away potential missiles from a table saw blade. It's *much* safer than using your fingers to remove wood scraps.

—From the WOOD shop

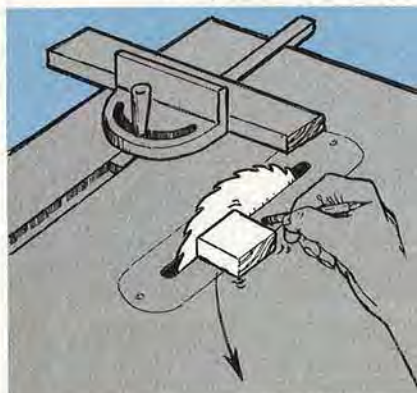

A tip from the sewing basket

Black or dark blue carbon paper becomes difficult to use when transferring paper patterns to dark wood. With the dark pattern outline, it's easy to make errors.

TIP: White carbon paper, found in many fabric and crafts shops, is ideal for transferring patterns to dark wood or 1/8" tempered hardboard. One manufacturer, S. B. Albertis Co., 322 W. 57th St., New York, NY 10019, markets their product under the name "Sara! Transfer Paper."

Cobert LeMunyan
Troutman, N.C.

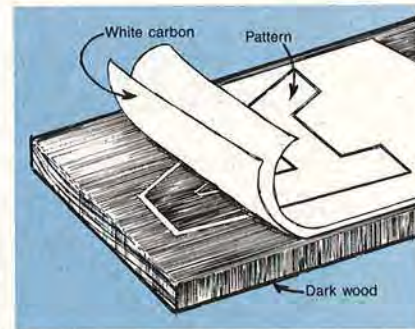

Sanding shortcut

Sanding those small, commercially available spindles can consume a lot of time and sandpaper.

TIP: Use a drill press to speed this process. Place one end of the spindle in the chuck (finger-tighten only). Then drive a no. 6 finishing nail through a piece of scrap and place the scrap (nailhead side down) on the drill-press table. Secure with a C-clamp. Each end of the spindle should have a small hole where attached to the lathe. Lower the spindle hole over the nail, turn on the drill press, and sand.

Richard J. Wessels
St. Louis Park, Minn.



Continued on page 12

At last! A wood filler that won't shrink, crack or fall out!



Repair cracked wood



Restore damaged wood



Rebuild rotted wood

New High Performance Wood Filler by Minwax. It's nothing short of amazing! This remarkable, all-purpose wood repair product fixes split, damaged or rotted wood, indoors or out, without the shrinking or crumbling typical of other wood fillers.

You can drill, shape, sand, and paint or stain in less than half an hour after you use it. High Perfor-

mance Wood Filler has excellent adhesion to wood. It's weather, water and rot resistant. That's why it won't shrink, crack or fall out. Use it on boats, decks, furniture, window sills, you name it.

For more information on this and other fine Minwax products, send for our free 30-page booklet, *Tips on Wood Finishing*.

Minwax Company, Inc., Dept. WO-115
P.O. Box 426, Little Falls, NJ 07424

Please send free booklet.

Name _____

Address _____

City _____ State _____ Zip _____



Minwax makes wood beautiful.

©Minwax is a registered trademark. ©1985 Minwax Company

The New Delta 16" Motorized Band Saw.



The small-scale machine
that handles large-scale work.

How'd we pack 16" from blade to frame and 8" in depth of cut into such a compact little beauty? We gave it three wheels, not two, for higher capacity without more bulk. A rigid C-type cast-iron frame and 16" x 16" ribbed cast-iron table, to take on your biggest project with ease.

But it isn't just for big projects. It can cut curves to within 1/4" radius. And it isn't just for wood. It cuts plastic, aluminum, or sheet metal. We even include a rip fence and miter gauge for more versatility.

And, like all Delta machinery, we include the 50 years of expertise that has set standards industry-wide. All this, at a competitive price. Our new band saw doesn't need to be big to do big jobs; we figure its price doesn't either.

Call toll-free for the name of your Delta distributor. Delta International Machinery Corp. (formerly Rockwell Power Tool Division), 800/438-2486 (in PA, 800/438-2487).

DELTA
Behind Our New Name Is Our Old Reputation.

TIPS FROM YOUR SHOP (AND OURS)

Continued from page 10

Improved miter stop

Sawdust build-up at a table saw miter stop can produce uneven lengths of pieces.

TIP: Cut a 1/8" x 1/8" notch in the block of wood used for a miter stop. In addition to solving the problem of sawdust build-up, the notch allows more freedom for the point of the mitered piece to fit snugly against the stop.

—From the WOOD shop

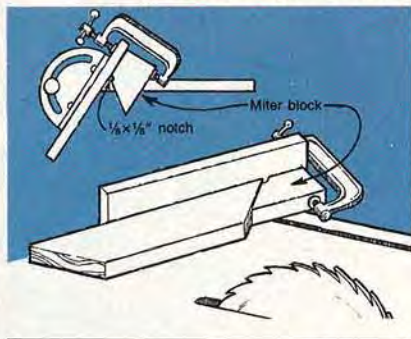

Oh, nuts! ★!★

There it goes again

Once again you're digging through sawdust to find the arbor nut you dropped while changing the blades on your table saw.

TIP: Slip the nut onto your index finger. Then, while controlling the nut with your thumb and middle finger, place the tip of your index finger on the arbor shaft. Keep your index finger in contact with the arbor and spin the nut with your middle finger and thumb.

—From the WOOD shop

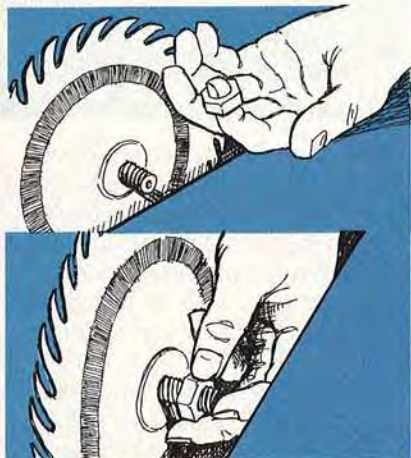

Continued on page 14

RYOBI TOOLS			List	Sale
S500A	3x5 1/2 Finish Sander	70	41	
SU6200	Finishing Sand, 1/2 Sheet	142	88	
B7075	3x21" dustless Belt Sand	179	116	
B7100	3x24" dustless Belt Sand	208	140	
B7200A	4x24" dustless Belt Sand	269	165	
D100VR	3/8" VSR 0-1200 rpm drill	91	49	
W640	7 1/4" 13 amp circular saw	158	99	
W740	8 1/4" 13 amp circular saw	171	109	
JS60	Jig Saw-Single Speed	172	99	
JS60G	Jig Saw-electronic v/speed	198	123	
R150	1 H.P. Plunge Router	138	86	
R330	2 H.P. Router	220	138	
R500	3 H.P. Router	265	163	
E3800	Drywall screwdriver 0-4000	126	79	
L120U	3 5/8" Planer	142	89	
BD1020R	3/8" 2 spd Cordless Drill w/re hoister Xtra special buy	148	95	
TS251U	10" Mitre Box	300	169	
SG150C	4 1/2" H.D. Mini-Grinder	99	59	

YOUR ATTENTION PLEASE!
All Above RYOBI TOOL Prices
Take Additional 10% OFF Sale Prices

MILWAUKEE TOOLS			List	Sale
0224-1	3/8 drill 4.5A magnum	159	109	
0234-1	1/2 drill 4.5A magnum	159	115	
0244-1	1/2 drill 4.5A magnum	159	115	
0222-1	3/8 drill 3.3A 0-1000 rpm	146	99	
0228-1	3/8 drill 3.3A 0-1000 rpm	129	95	
0375-1	3/8 close quarter drill	175	118	
0210-1	3/8 cordless drill	154	114	
6539-1	cordless screwdriver	84	64	
1007-1	1/2" drill 4.5A D-Hdle	199	145	
1107-1	1/2" drill 4.5A D-Hdle	204	145	
3300-1	magnum rt angle drive kit	249	170	
3102-1	Pimbrs rt angle drill kit	263	180	
1676-1	HD Hole Hwlg w/cse 2 sp	333	235	
5395	3/8 sgle sp hammer drill kit	203	150	
5397	3/8 sp hammer drill kit	208	155	
5371-1	HD mag hammer drill 1/2"	287	207	
5373	HD mag hammer drill 3/8"	240	175	
6511	2 speed Sawzall w/case	181	123	
6226	port band saw 2 sp w/case	382	280	
6234	TSC band saw port w/case	382	280	
6305	7 1/4" circ saw 13 amp	159	109	
6465	8 1/4" circ saw 13 amp	179	127	
6460	10 1/4" " 15 amp w/case	349	245	
6377	7 1/4 HD worm saw 13 amp	235	155	
6378	8 1/4 HD worm saw 13 amp	249	165	
6175	12" Chop Saw 15 amp 4200 R.P.M.	267	189	
6170	14" Chop Saw 15 amp 3600 R.P.M.	289	209	
6255	v/spl Jig Saw 3.8 amp	199	140	
6245	sple sg Jig Saw 3.8 amp	175	125	
6012	1/2 sheet HD Orb sander	159	110	
6014	1/2 sheet HD Orb sander	169	115	
5935	4" by 24" belt sander w/bag 10 amp	219	125	
5660	1 1/2 HP router 10 amp	256	175	
5680	2 HP router 12 amp	314	220	
8950	Wet/Dry 8 gal vac 6 amp	145	110	

BENCH GRINDERS

4901	1/2 HP 2.6 amp 24"	159	110
4921	1/2 HP 4 amp 26"	179	130
4891	1/2 HP 4 amp 4 1/2"	279	195
5041	3/4 HP 8.2 amp 5 1/2"	379	270

DRYWALL SHOOTERS

6753-1	3.5 amp 0-4000 rpm new	115	79
6747-1	4.5 amp 2500 rpm	144	100
6750-1	4.5 amp 0-4000 rpm	129	90

MILWAUKEE Super Specials!

Model 6507 Trigger Speed Control Sawzall w/case & blades... List 193... Sale 125.
Go Cordless with MILWAUKEE
#6305 - 6 1/2" Cordless Circular Saw 12 volt - 1 Hour Charge Cuts (80) 2x4's (Pine)
List Price 195.00 * SALE PRICE 135.00

FREUD SAW BLADES

Item No.	Description	Diam.	Teeth	List	Sale
PS203	Gen'l Purp.	7 1/4"	24	27.24	17.50
PS303	fine cutting	7 1/4"	40	32.97	20.50

5/8" Bore - Industrial Grade CARBIDE TIPPED SAWBLADES

Item No.	Description	Diam.	Teeth	List	Sale
L072M010	Gen'l Purp.	10"	40	68.58	34
L081M010	Gen'l Purp.	10"	40	69.30	35
L073M010	Cut-Off	10"	60	79.65	36
L082M010	Cut-Off	10"	60	86.40	44
L084M010	Combination	10"	40	70.39	36
L084M011	Combination	10"	50	74.51	37
L085M010	Super Cut-Off	10"	80	110.88	62
LM72M010	Ripping	10"	24	64.85	34
DS 306	8" Dado			139.00	92
DS 308	8" Dado			170.00	105
TR 100	3 blades & Dado set			399.00	255

FORSTNER BITS (ARCO)			West Germany	List	Sale
Model	Size				
2121	1/4	6.40	4.00		
2122	3/8	7.00	4.50		
2123	1/2	7.80	5.00		
2124	5/8	10.35	6.50		
2125	3/4	10.95	7.00		
2126	7/8	11.40	7.25		
2127	1	12.25	7.75		
2128	1-1/8	12.75	8.00		
2129	1-1/4	13.85	8.75		
2130	1-3/8	16.45	10.50		
2131	1-1/2	18.15	11.00		
2132	1-5/8	21.25	14.50		
2133	1-3/4	23.95	16.50		
2134	1-7/8	25.50	17.50		
2135	2	26.25	18.25		
2136	2-1/8	30.50	20.50		

16 Pieces (one of every size above)
List Price 254.80 * SALE PRICE 150.00
4 Pieces (1/2 - 5/8 - 3/4 - 1")
List Price 38.95 * SALE PRICE 25.00

MAKITA TOOLS			List	Sale
804510	Sander	79	43	
99008	3 1/2 x 21" belt sander	198	119	
99248	3 1/2 x 24" belt sander	188	135	
99240B	3 1/2 x 24" belt sander w/bag	214	130	
9035	1/2 sheet finish sander	79	48	
9045B	1/2 sheet finish sander	156	90	
9045N	1/2 " " " w/bag	156	105	
9045H	4-3/8 circ saw 7.5 amp	152	95	
5008NB	8 1/4 circ saw 13 amp	178	105	
5011NA	10 1/4 circ saw 12 amp	348	215	
43008V	v/spl jig saw 3.5 amp	192	120	
43018V	orb v/spl jig saw 3.5 amp	208	125	
24018W	10" mitre saw	329	185	
24008W	10" mitre saw (for vice)	369	249	
JR3000WL	2 sp recip saw w/cse	168	120	
JR3000V	v/s recip saw w/case	178	120	
6010DKW	3/8 cordless drill w/case	152	89	
5081DW	3-3/8 cordless saw kit	105	109	
1900BW	3 1/4" planer w/case	154	92	
1100HD	3 1/4" planer w/case	276	160	
3608BK	3/4 hp router w/case	132	85	
3601B	1-3/8 hp router	168	115	
3700B	1/2 hp trimmer	124	82	
804530	6" Round Sander	84	55	
67100W	Cordless Screwdriver	148	105	
DA3000	3/8" angle drill	158	105	
DP4700	1/2 v/spl w/s.r. 4.8 amp	154	92	
HP1030W	3/8 v.s.r. hammer drill w/case	145	98	
6300LR	1/2" angle drill w/rev	229	152	
84198B-2W	2" sp. hammer drill w/case	238	150	
GV5000	Disc Sander	79	53	
6800DB	2500 rpm 3.5 amp	123	79	
6800DB	0-2500 rpm 5 amp	133	89	
68010B	4000 rpm 3.5 amp	123	79	
68010BV	0-4000 rpm 3.5 amp	133	89	
2030N	12" planer/jointer	1980	1350	
2040	15-5/8" planer	1780	1195	
1805B	6-1/8" planer kit w/case	416	285	
LS1400	14" Mitre Box	578	410	

*** NEW from MAKITA!**

Model	Description	List	Sale
9820-2	Blade Sharpener	235	160
68020W	3/8" 2-sp c/less drill kit	154	94
6010SDW	3/8" cordless drill rev	82	45
DA3000DW	3/8" c/less angle drill	172	105
JV1600	var. speed jig saw	145	89
JV2000	var. speed orb. jig saw	185	100
4300DW	cordless jig saw	158	102
5005BA	5 1/2" circular saw 8 amp with brake	154	98
5600DW	6 1/2" c/less circ/saw	224	139
9207SPC	7" var/speed electronic sander/polisher	209	130
9303BH	4 1/2" sander-grinder kit	146	95
9035DW	c/less finishing sander	128	79
4014NV	var/speed blower	128	79

*** DELTA**

Model	Description	List	Sale
34-621	9" contr. saw w/o motor	500	395
34-410	10" contr. saw w/o motor	671	650
34-710	super 10" motorized saw	579	450
15-091	15" floor model D/press	467	375
15-090	15" bench model	467	375
37-207	Saw/Jointer Combination	1018	810
37-609	6" Motorized Jointer	413	335
37-290	4" Delta Joiner w/o motor	348	275
22-651	RC-33 - 13" Planer	1943	1450
43-122	Wood Shaper w/stand and 1 HP Motor	669	495
46-140	11" lathe, gap bed model w/stand w/o motor	407	335
52-493	1 hp motor for #34-621	170	130
62-042	1 1/2 hp motor for #34-410	230	170
62-144	1 1/2 hp motor for #37-290	138	105
62-142	1/2 hp motor for #28-243 and #46-140	121	85

1985 TOOL CATALOG AVAILABLE
Call Toll-Free 1-800-328-0457 - In Minnesota Call (612) 224-4859
4 WAYS TO BUY: CHECK MONEY ORDER - VISA - MASTERCARD
SEVEN CORNERS ACE HDW., INC.
216 West 7th St. • St. Paul, MN 55102 • Est. 1933

SAW-A-THON by PORTER-CABLE

#314	4 1/2" trim saw	List 180	Sale 109
#346-1	6 1/2" top hdl	List 161	Sale 100
#617	7 1/4" Push Hdl	List 168	Sale 103
#587	7 1/4" Speedronic	List 199	Sale 125
#315-1	7 1/4" Top Hdl	List 166	Sale 103
#368-1	8 1/4" Top Hdl	List 176	Sale 110

*** DELTA SUPER SPECIALS!**

#33-150	SAWBUCK	List 658	Sale 489
#28-560	BANDSAW	List 449	Sale 348

#28-283 14" Band Saw

with enclosed Stand and 3/4 hp Motor
List \$897.00
Sale \$675.00

#28-243 14" Band Saw

with Open Stand without Motor
List \$594.00
Sale \$440.00
#22-651 13" Planer
List \$1943.00
Sale \$1295.00

TOOLS ON SALE

AMERICA'S LOWEST PRICED TOOLS
* PLUS * ... FREE ... Freight On Every Item

SUPER CORDLESS SPECIALS from BLACK & DECKER

Model	Description	List	Sale
1930	3/8" rev/hl speed	165	110
1950	3/8" High Torque	165	110
5930	Reversible Hammer	179	120
1970	3/8 rev/hl torque screwdriver	179	120
1980	Rev adj. clutch Scruddrill	179	120

BRAND NEW! SUPER SPECIALS from MILWAUKEE

0214-1	3/8" c/less driver/drill	154	109
8975	H.D. Heat Gun, 11.6A Low 570°F - High 1000°F	69	49
5920	belt sander 3x24 w/o bag	289	199
5925	belt sander 3x24 w/bag	309	215
5930	belt sander 4x24 w/o bag	299	209
5935	belt sander 4x24 w/bag	319	225

BRAND NEW! BLACK & DECKER

#9425 8 1/4" Compound Mitre Saw
Special Sale Price - \$115.00

PORTER-CABLE (buy of the year)

Model 621 REVERSING DRILL
3/8" H.D. var/speed-4 amp 0-1000 rpm
List 120
6 or more \$69.00 each

*** * * ROUTER RIOT by PORTER-CABLE * * ***

The World's Least Expensive Scroll Saw?

TIPS FROM YOUR SHOP (AND OURS)

Continued from page 12

Cut painting time in half

All sorts of problems arise when you need to paint or finish the second side of a project. You can either wait for one surface to dry before turning the piece over, or you can finish both surfaces the same day and expect a lot of touchup on the side painted first.

TIP: Drive $\frac{3}{4}$ " brads through scraps of $\frac{1}{2}$ " wood. Arrange three or more of these spacers on your work surface, turn the piece over, and continue painting on a horizontal surface. Save and reuse blocks of wood later.

James C. Hunt
Southgate, Mich.

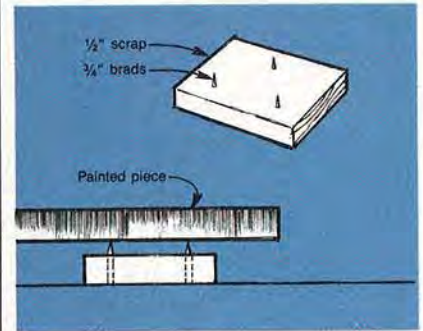

New angle on gluing corners

Triangular blocks often slip when you clamp 45° mitered corners.

TIP: Double-face carpet tape to the rescue again! A layer of tape on one surface of triangular block makes a world of difference when clamping mitered corners. After the glue has dried, save the blocks and reuse them on your next project. (Stay away from thin double-face tapes that don't have a lot of sticking power.)

Marvin C. Betcher
Davenport, Ia.

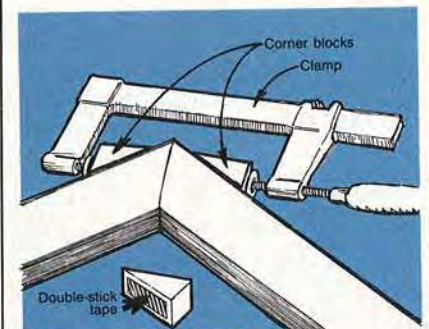

Continued on page 16



That's right. If you've been considering a scroll saw, you've thought you couldn't afford a HEGNER. But they learned, so did you. It's a tool than to buy one. In the long run, that's a HEGNER. To celebrate 30,000 HEGNER saws sold, AMI, Ltd. and HEGNER offer you the opportunity to get any HEGNER saw for less from now until December 15, 1985. **SAVE \$150!** Details from AMI or your dealer. **HEGNER** than to any other: today!

AMI Ltd. is your source for HEGNER Saws, Lathes and Duplicators; FELDER Woodworking Systems; FLOTT Jointer/Planers and Table Saws; and Lachappelle Workbenches.

Please send me free information on **HEGNER** Precision Scroll Saws.

Name _____
Address _____
City, State, Zip _____
Phone _____



Advanced Machinery Imports
AMI, Ltd., PO Box 312, Dept. 55
New Castle, DE 19720
302-322-2226

Your home workshop can PAY OFF BIG!



This One Low-Cost Power Tool—
SAWS to desired Width...
PLANES to desired Thickness...
MOLDS all popular Patterns...

—All at once or separately... **All By Power Feed!**

The Only Complete Workshop Tool Of Its Kind In The World!

From the Day It Arrives... the Planer will make and save you money. With shortages and inflation driving lumber prices sky-high, this versatile power tool quickly pays for itself by easily converting low cost rough lumber into high value finished stock. In just one pass turn out your own quarter-round, door and window stop, casing, tongue-and-groove... all popular patterns. Other operators are making cases for grandfather clocks, furniture, picture frames, bee hives, bed slats, surveying stakes... all kinds of millwork.

Built For Pros... Priced For Home Craftsmen... it is engineered and built to industrial standards, but factory-direct selling keeps the price low. Handles tough oak and walnut as easily as pine, and so simple to operate even beginners with no experience can use it.

**Start
Your Own
Business!
Earn Extra
Income
Right At
Home.**

With just this one low cost power-feed machine in a corner of your garage or basement, you're set up to supply lumberyards, cabinetmakers, carpenters, remodelers, contractors and hobbyists in your area with custom-planed lumber, trim, molding... ALL of their millwork requirements. You can supply picture molding to art shops, hardware and department stores, or sell direct to framing shops. All standard patterns are available from stock, or we'll custom grind a knife to your own special design or sample.

Does The Foley-Belsaw Pay? YOU BET!

READ WHAT OWNERS SAY:

A Good Investment • Robert Sawyer, Roseburg, Oregon: "I believe that the Foley-Belsaw is the best investment I ever made. I've been a planer man for years and am now retired. The Foley-Belsaw has earned me \$60,000 extra income in the past eleven years."

Pays For Itself: • R.S. Clark, Springfield, Ohio: "I bought a batch of walnut in the rough, and after planing it on the Foley-Belsaw I figured up the money I saved. It was enough to pay for two-thirds the cost of the Planer. It really does a good job."

More Than Expected • Stephen Schultz, Orangeville, Penna.: "This machine pays for itself by making money out of scrap boards. It is a very well built machine and I confess it is more than I really expected for the price. It does everything you say it will."

... And Foley-Belsaw Is The Choice Of Professionals:
"I recommend Foley-Belsaw Planer-Molder-Saw as the most useful shop tool any craftsman could own. We use one every day in the Workbench model shop, and couldn't get along without it."

JAY HEDDEN — Editor WORKBENCH Magazine

Try The
Foley-Belsaw In Your
Own Shop On Our
**30-DAY FREE
TRIAL OFFER**

Mail Coupon Below
For Complete
Details!

**You Take NO RISK! The Planer/Molder/
Saw Is Backed by Our Exclusive 100%
Guarantee of Satisfaction:**

• "Try the Foley-Belsaw in your shop for a full 30-Days and put it to work for you. Give it a thorough test and make it prove that it can do everything we say it will... use it just as much as you want. Then if you are not completely satisfied, just send it back and we'll return every penny you sent. And YOU are the sole judge! There are no questions asked... there are no fine print 'use' charges. Our flat guarantee is that YOU must be 100% satisfied or you get your money back."

**FREE
BOOKLET!**

Get FREE
Book with
facts and
full details
... RUSH COUPON TODAY!



If coupon has been removed, just send postcard with name and address to:

FOLEY-BELSAW CO.
90718 FIELD BLDG.
KANSAS CITY, MO 64111

**Just Mail Coupon...
NO OBLIGATION and
NO SALESMAN Calls!**

**ACT NOW!
Coupon
Brings
Full Details!**



FOLEY-BELSAW CO.
90718 FIELD BLDG.
KANSAS CITY, MO 64111

YES, please send me the FREE Booklet that gives me complete facts about your Planer-Molder-Saw and full details on how I can qualify for a 30-Day Free Trial right in my own shop. I understand there is No Obligation and that No Salesman will call.

NOW YOU CAN...
Turn Extra Time
Into
Extra Income!
FOLEY-BELSAW POWER TOOLS



NAME _____

ADDRESS _____

CITY _____ STATE _____ ZIP _____

Continued from page 14

File away a boring problem

Without using an expensive Forstner bit, it's next to impossible to bore holes without breaking through the opposite side (i.e., when drilling a 1/2"-deep hole in 3/4" stock).

TIP: By filing down the point of a spade bit, you can achieve the depth of cut you want without breaking through the other side. Even if you buy an extra spade bit just for this use, it still is cheaper than a Forstner bit.

Charles Hughes
Hamburg, N.Y.

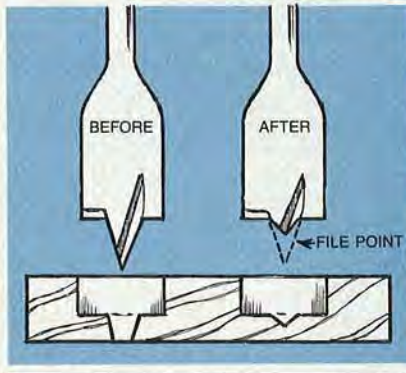

Noteworthy idea for shop scribblers

All too often, there's not a scrap of paper within reach to jot down figures after taking measurements.

TIP: You'll always have paper as near as your tape measure if you rubber-cement a piece to your tape-measure case. You can write and erase many sets of figures before replacing the paper. Those yellow self-adhesive notes also work well.

Steve Tegtmeier
Pittsburgh, Pa.

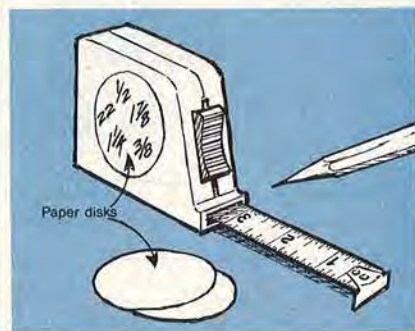

A real finger-saver

Fingertips and fingernails often get sanded as much as the wood when smoothing small parts.

TIP: Wrap masking tape (sticky side out) around a block of wood, and secure it with two pieces of masking tape wrapped the opposite direction. Stick the stock to be sanded to the masking tape and move the block across a sheet of sandpaper. You'll have the best results when the sandpaper is glued to a smooth surface.

Alex W. Flinsch
Garfield, N.J.

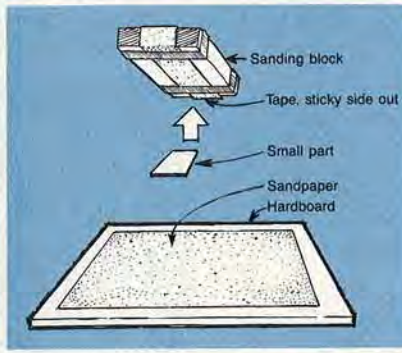

Bottoms up!

Supporting larger, floppy workpieces while doing inside cutting with a jigsaw can be a challenge. These projects often require a lot of stopping and turning to avoid sawing into the work surface.

TIP: Here's yet another use for those versatile, portable worktables. Turn the table upside-down and support the wood with the four legs while using your saber saw. You'll fast find this more convenient than sawhorses. ■

Dustin Davis
Frostburg, Md.



Introducing
TotalAire
The air compressor
with power.

Here are just a few of
its features:

- 1/2HP motor puts out 3.3 cubic feet of air per minute.
- 2.6 gallon tank.
- 150 PSI capacity.
- 68 lbs. weight.
- Wheels and handle for easy moving.
- No belts.
- No pulleys.
- Pop-off safety valve.
- Can be used with air tools for spray painting, to pump tires, or to clean woodworking shops, etc.

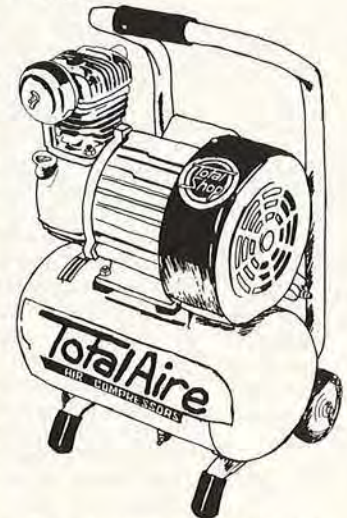

ON SALE NOW.
(Regular \$419.00 — Now \$269.00)
Delivered in continental U.S.

CALL TODAY
toll free
1-800-845-9356
in S.C. call
288-4174

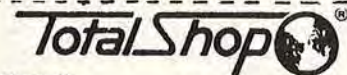

Dept. Q
P.O. Box 16297/Greenville, S.C. 29606

Your Name _____
Address _____
City _____ State _____ Zip _____

□ Total Aire air compressor

COMPARE *TotalShop*®

WITH SHOPSMITH.®
You'll actually see
the improvement.

For Example:

1. 1½hp motor develops nearly 3hp while Shopsmith® motor is 1½hp developing 2hp.
2. Motor can be altered by owner to 220V. Shopsmith® does not have this option.
3. In more than 85% of the comparisons, the Shopsmith® machine is priced higher than the *TotalShop*® machine.

*Let us send you 11 more reasons
Total Shop is a better buy.*

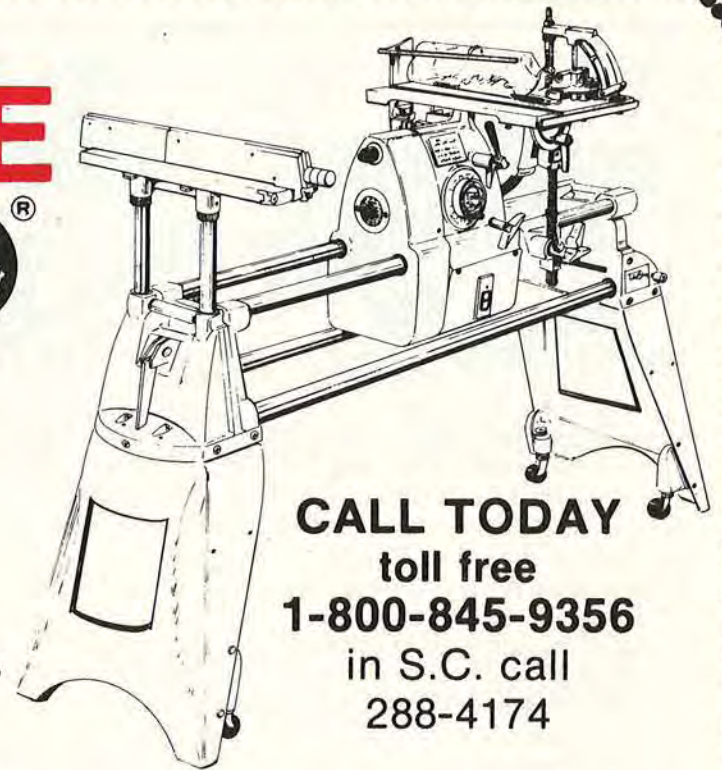

CALL TODAY
toll free
1-800-845-9356
in S.C. call
288-4174

TotalShop®

has proudly
created an in-home
**WOODWORKING
VIDEO.**

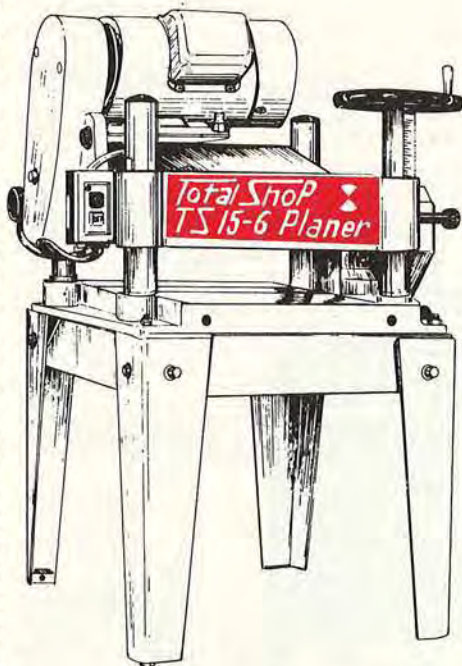

TotalShop®

TS 15-6 Planer

- 110 V or 220 V
- Stand & dust collector available
- 2 HP or 5 HP motor
- 15" width, 6" thickness

- The first of its kind!
- 30-min. presentation of the Total Shop and the TS 15-6 Planer.
- In-home viewing.
- \$20.00 refundable deposit.
- Available in VHS and Beta.

Now you can see
our product at work
before you buy.

clip and mail coupon for: Free Informational Kit

TotalShop®

Dept. Q
P.O. Box 16297/Greenville, S.C. 29606

Your Name _____

Address _____

City _____ State _____ Zip _____

Phone _____

- Multipurpose tool TS 15-6 Planer
 Video (\$20.00 deposit enclosed)

©United Metal Services, Inc.

Attention Shopsmith® Owners:
Call today for our accessory brochure
and save money.



The fingers you save . . .

Shophelper Safety Guides keep your hands away from finger-gobbling blades and cutters. The infeed wheel holds material down to stabilize the cut and guard against chatter. The outfeed wheel controls ripping until the stock is clear of the cutter area. Locking clutches prevent kickback. *Shop-helper. Available through retailers and catalogs. We ordered ours for \$83 postpaid from Western Commercial Products, P.O. Box 1202, 1515 E. Sunset Ave., Dept. W, Tulare, CA 93275.*



Cut your own wheels

If you're into toymaking, you know that wooden wheels, especially larger ones, can be expensive. Why not make your own with the Wheel Right? It's simple to use: Just drill halfway through a board, flip the board over, line up the pilot hole, and complete the drilling. Standard knives included in the kit cut 1½" to 4½" outside-diameter wheels. You also can special-order custom-made knives. *Wheel Right, \$61.95 post-paid from The Tool Company, P.O. Box 629, Dept. W, Harrisonville, MO 64701.*



Try this Japanese waterstone

The Japan Woodworker, a California retailer, keeps a close eye on all Japanese woodworking tools, including the many waterstones now available. At their suggestion, we tested the 7½×2½×½" King S-3 Shiage Toishi, a 6,000-grit finish stone for final polishing. The results were excellent. *King S-3 Shiage Toishi Waterstone. Available through retailers and catalogs. We ordered ours for \$11.95 post-paid from the Japan Woodworker, 1731 Clement, Dept. W, Alameda, CA 94501 (catalog #01.098.03).*

Continued on page 20

INCA

A Better Bandsaw

INCA Model 330 10" Bandsaw

Resaw a 6" thick hardwood slab into ½" boards for your next cabinet. Cut the graceful curves of a Queen Anne leg. Build toys for the kids. Cut the tenons for a trestle table.

Part of the complete INCA line, featuring **Cast Construction** and our **Five Year Limited Warranty**.

See your **Local INCA Dealer**.

For the name of your INCA Dealer, and a **FREE Brochure** write to: Injecta Machinery Corp., Dept. 514, 10 Van Dam Street, NY, NY 10013.



INCA 51 Years of Quality Woodworking Machinery



LEIGH DOVETAIL JIGS

Infinitely variable dovetails with ease and accuracy.

For free brochure call or write—

—U.S.A.: 1-800-663-8932 Toll free

—Canada: (604) 992-2440 Collect

LEIGH INDUSTRIES LTD.

Box 4646-B

Quesnel, B.C.

Canada V2J 3J8



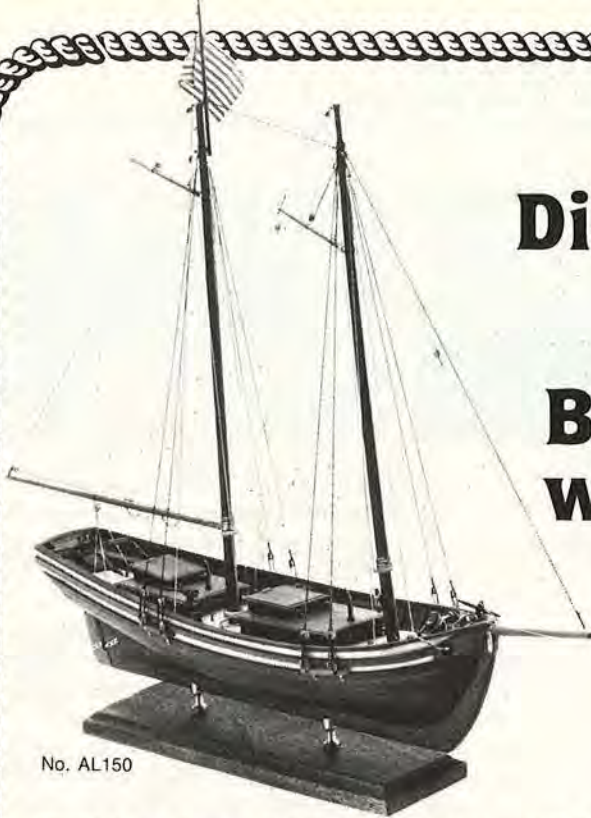

No. AL150

Discover the world's oldest hobby!

Build this beautiful wooden ship model.

Special offer for those who have never built a ship before!

Wouldn't you love to build this historic ship model? It's a true-to-scale, 21" replica of the 2-masted schooner *Swift*, a Virginia pilot boat of 1805. Well, now you can! And you don't have to be a skilled craftsman to do so.

It really isn't hard

Even if you've never built a model before, you can experience the relaxing pleasure and pride of accomplishment that is offered by this fascinating hobby. You can build the *Swift*. The secret's in our kit, designed especially for the first time modeler, with pre-cut parts that make assembly easy. Clear, large scale plans and instructions that virtually take you by the hand and guide you every step of the way through hours of the most relaxing fun you'll ever have. And when completed—a museum quality model you'll display with pride, with gleaming brass fittings, walnut planked hull, delicate rigging—lifelike in every detail.

Quality you can see and feel

The materials in our kit may be better than those used in the original *Swift*. The keel section and frames are pre-cut plywood, ready for quick assembly. The *Swift's* hull is planked twice; once with thick, flexible limewood for strength, then overlaid with planks of African walnut for lasting beauty.

You won't have to make the fittings—we've done that for you. Our kit contains ready-to-use blocks and deadeyes

of rare, yellow boxwood. We include eyelets, bracers and belaying pins—over 70 parts of solid brass! Even the cabin door hinges are brass, as are the 250 miniature nails you'll use to fasten the planking to the hull and deck. And, since the original wooden *Swift* had no plastic parts, our kit doesn't either—*anywhere!*

Creative? And how! Overwhelming? Not a bit! But be prepared for hours of the most challenging, engrossing, relaxing fun you've ever had.

An "everything you'll need" special offer, with free tools and handbook.

We want to introduce you to this great hobby, *now!* So we've made it easy for you to get started. Our special offer includes the *Swift* kit plus all the tools you'll need to build her: pliers, hammer, knife, file, tweezers, sandpaper, glue, wood oil, and more. You'll also receive a free copy of "Ship Models from Kits," a 110 page beginner's guide. You don't have to buy anything else. The tools normally cost \$17; the book retails for \$7.95. But they're yours, FREE when you buy the *Swift* kit at its regular price of \$39.95 (plus \$4.00 for delivery).

Credit card holders order toll-free

Call 800-228-2028, ext. 68, 24 hours a day. In Nebraska, call 800-642-8300. Use Visa, Mastercard, American Express, or use coupon below to send check or money order.



Easy-to-build hull.



Everything you need to build...included.

Miniature Cannon Kit Bonus!

Set of two solid brass cannon on walnut carriages to be mounted amidship. \$4.00 value, sent FREE with your order.



model expo, inc.

23 Just Road, Fairfield, N.J. 07007

MODEL EXPO, INC. 23 Just Road, Fairfield, NJ 07007 Dept. BHW 115

Please send me ___ kits of the *Swift* (No. AL150) at \$39.95 plus FREE tools, book and cannons. Check or money order enclosed. (Add \$4.00 for delivery. NJ residents must add 6% sales tax.)

Name _____

Address _____

City _____ State _____ Zip _____



116 page full color hobby catalog sent FREE with your order.

If less than delighted, you may return your purchase within 30 days for a full refund.

© Model Expo, Inc. 1985



Factory Lumber Outlet

"Woods of the World"

200 SHREWSBURY STREET
BOYLSTON, MASSACHUSETTS 01505

We stock over 100 species of domestic & exotic woods including:

- All Domestic Woods
- Apple
- Balsa
- Bengé
- Brazilian Rosewood
- Bubinga
- Ceylon and African Ebony
- Ceylon Satinwood
- Cocobolo
- Curly and Birds Eye Maple
- East Indian Rosewood
- English Brown Oak
- European Pearwood
- Goncalo Alves
- Holly
- Honduras Mahogany
- Honduras Rosewood
- Iroko
- Jelutong
- Macassar Ebony
- Mahogany
- Mexican Rosewood (Bocote)
- Padouk
- Philippine Mahogany
- Purple Heart
- Shedua
- Teak

During more than a half century as millwrights and cabinetmakers, we have become experts in acquiring and working with the finest hardwoods and softwoods. Our knowledge of the best domestic and worldwide sources of rare woods is without peer. The large volumes in which we buy fine woods affords us the best possible prices which, in turn, we pass along to you. lacCarino and Son is also your source for the finest lines of high quality woodworking hand tools.

Call For Free Catalog

(617) 869-2791

TOLL FREE:

In Mass. 1-800-521-0039
New England 1-800-222-1420

PRODUCTS THAT PERFORM

Continued from page 18

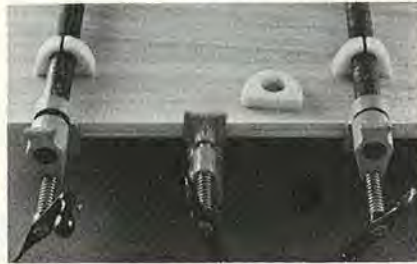

Dent-free clamping

Does this sound familiar? You eagerly remove the clamps from a just-glued project, only to discover a scratch, dent, or stain left by a metal clamp. Cabinetmaker Greg Willis had the same problem, and he solved it by developing a line of long-lasting urethane clips. The configuration shown here slips onto $\frac{1}{4}$ " pipe clamps. Other styles and sizes accommodate other types and sizes of clamps. *Clamp Clips*, \$5.95/pr. Available through woodworking catalogs or Heritage Tool Co., Box 226, Dept. W, Hampstead, MD 21074. \$2.50 charge for postage and handling on all orders. Write Heritage first for an order form so that you can select the exact size and style you need.



Putting some light on the subject

It's hard to imagine having fun with a lamp, but here you have it: There's something "magnetic" about this model (pun intended). The magnet allows you to place this lamp where you need it, quickly and easily. A 60-watt bulb in the reflector throws plenty of light, too. *Magnetic Lamp*, model #1439. Available for \$21.95 from Grizzly Imports, Inc., P.O. Box 2069, Dept. W, Bellingham, WA 98227.

Straight talk about scraping curves

When violin and guitar makers need to scrape the contours of their creations, they use extra-thin scrapers to reduce stock. Because these German-made scrapers (sold in pairs) are just .4 mm thick, they conform to many surfaces in restricted areas. Even some wood sculptors find these scrapers handy enough to add to their tool chests. *Extra-thin Scrapers* (catalog #08E44-DL). Available for \$3.90/pr. postpaid from Woodcraft, 41 Atlantic Ave., P.O. Box 4000, Dept. W, Woburn, MA 01888.

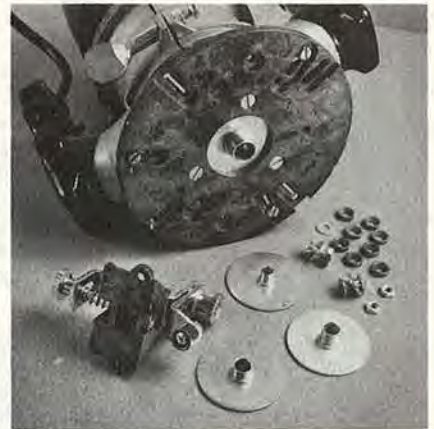

Round out your router

This kit offers a low-cost way to enhance your router's capabilities. Guide bushings in a variety of sizes team with a template to make decorative shapes. The edge guide expands the versatility of the router when you use nonpiloted router bits. *Router Roller Edge and Guide Bushing Kit*. We ordered ours for \$15.95 postpaid through Trendlines, 375 Beecham St., Dept. W, Chelsea, MA 02150 (catalog #VA23459).

Continued on page 23

CLASSIC CAR PLANS

Easy To Build Full Size Plans



FOR CATALOG OF AVAILABLE FULL SIZE PLANS • SEND \$1.00 TO:



Route 6
Box 29
Neosho, MO
64850

Full-Size FURNITURE PLAN 18th Century PINE CRADLE

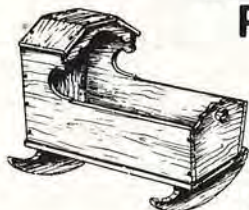

Authentic 18th Century design. All joints hand-pegged like the original. 36" long by 29 1/4" high. Perfect for fireplace wood, magazines. Baby, too! A woodworker's delight!

Order plan #120 ... \$8.00

CATALOG

180 diff., full-size prof. furniture plans—\$2.00 (catalog free with order)

FURNITURE DESIGNS, Dept. PS-115
1425 Sherman Ave., Evanston, IL 60201

NEW! AFFORDABLE 24" KIT SCROLL SAW

FINALLY — At last a 24" throat precision scroll saw that is affordable to any woodworker — saw complete or kit form.

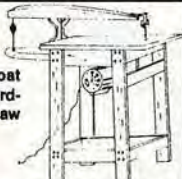

PEDAL SCROLL SAW

Beautiful all cast-aluminum reproduction of the time proven Velocipede No. 2 Scroll Saw. Great attraction when working craft shows. Total speed control. 24" throat can cut material modern scroll saws can't. Write or call—



Pedal
Power

THE TOOL COMPANY

1306 S. Commercial
P.O. Box 629, Dept. BHG-6
Harrisonville, MO 64701
(816) 884-2679

Mo. res. add 5.625% sales tax

National Carvers Museum

LEARN WOODCARVING AT HOME

Receive sample instructional pack on whittling and woodcarving. Includes copy of *Mallet* monthly magazine.

Send \$1.00 to The National Carvers Museum, 14960 Woodcarver Rd., Monument, CO 80132.

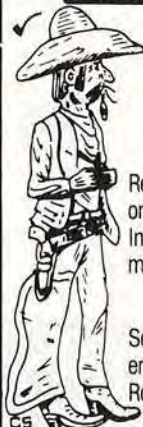

A Family Tradition Since 1916

Kuempel Chime

BUILD THE FINEST
We Know You Can Do It!

Easy to assemble quality Red-i-Kut Clock kits. A variety of designs hand made by our Grandfathers in solid 3/4" cherry, oak or walnut with beveled glass.

Tubular Bell or Rod movements. Handcrafted pendulums. Original bronze etched dials and hand painted moonwheels.

Or start from scratch. American Classic Plan - \$3.00

Write for Free
Literature
or Call

1-800-328-6445

Between 8 a.m. & 4 p.m.



Kuempel Chime

Dept. 008, 21195 Minnetonka Blvd.

Excelsior, MN 55331

Shophelper™ Safety Guides

US Patent #3-738-403



Finger-Saver

ANTI-KICKBACK STOCK FEEDER

- A system for controlling stock on saws, shapers and other stationary machinery.
- Single direction bearings guard against kickback and provide smooth, even cutting.

Set, complete with brackets, \$79.50

Additional Mounting Brackets available.

To Order Call: 800-344-7455; California: 800-828-8833
or Write: P. O. Box 238, Tulare, CA 93275

Dealer Inquiries Invited

User Friendly



OIL BASED • WATER CLEAN-UP
DRIES IN 2 HOURS • NON-FLAMMABLE
NO HARSH ODOR

Deft, Inc., Irvine, CA 92714 • Alliance, OH 44601

WOODWORKING MACHINES 5 in 1 Combination

- 1 • 34" LATHE
- 2 • 10" TABLE SAW
- 3 • 11 3/4" DISC SANDER
- 4 • 16 1/2" VERTICAL DRILL PRESS
- 5 • HORIZONTAL DRILL PRESS

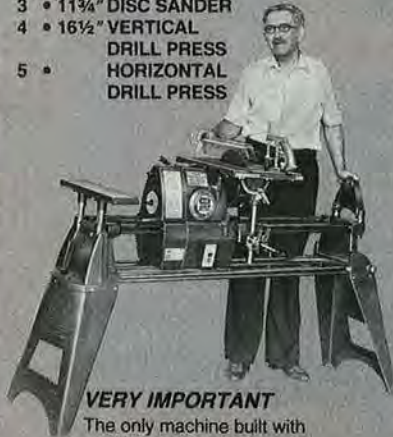

VERY IMPORTANT

- The only machine built with
- a. ALL CAST IRON TABLES
 - b. HEAVY-DUTY DESIGN
 - c. 1 1/2 HP MOTOR DEVELOPS 3HP
 - d. BUILT AS AN INDUSTRIAL MACHINE
 - e. ONLY MACHINE WITH 5-YEAR GUARANTEE

ONE PLACE FOR ALL YOUR NEEDS...

VISA MASTERCARD FINANCE AVAILABLE

PLANT:

MASTER WOODCRAFT CO.

800 SPRUCE LAKE DRIVE • P.O. BOX 669
HARBOR CITY, CA 90710

TOLL FREE 1-800 421-2467

IN CALIFORNIA CALL COLLECT (213) 549-0761

(A Republic-Lagun Group) • Dealership Available

OLSON

Saw Blades Economy • Quality • Value

You could pay 50 to 100% more and not get better blades. Made from the finest steels with sharp, filed, milled or precision-ground teeth for accurate sawing, smooth finishes and long life. Ideal for wood, plastics or metals in industrial, school and home workshops.

Send for **FREE** specification and price sheets
Dealer inquiries welcome.
We service what we sell.

YES! I am interested in more information on these Olson Saw Blades: Band saw (wood and metal cutting) Coping Scroll/Fret Spiral Jewelers Minihack Carbide-tipped circular

Name _____
School _____
Street _____
City _____
State _____ Zip _____



THE OLSON SAW COMPANY
A DIVISION OF BLACKSTONE INDUSTRIES, INC.
Bethel, CT 06801 • (203) 792-8622

STROM TOYS®



SCHOOL BUS
A bus to ride and turn. Top opens to take passengers. Great fun to play with before starting school. 25" long, 10" wide, 12" high. \$6.00 for plan.



SPARKY
This little horse will turn and zip around the house, like magic. Great fun for little ones. 20" long, 9" wide, 10 1/2" high. \$5.00 for plan.

BOOKS AVAILABLE

Strom Toys - 40 designs, 12 mini-plans, in color. \$9.95 PPD.
Gazebos - 93 designs, 3 mini-plans. \$7.95 PPD.
Backyard Structures - 65 designs for all kinds of storage, full color. \$8.95 PPD.
Privy - 25 designs to use for all kinds of needs. Funny history! \$7.95 PPD.
Bridges & Cupolas - 65 designs, many sizes. Some history. \$7.95 PPD.

P.O. Box 206, Dept. 34
Delafield, WI 53018
(414) 567-4255



SUN
DESIGNS

MONEY BACK
GUARANTEE

MC & VISA ACCEPTED

**NEW! High-Precision
SCROLL
SAW
AT A
SENSIBLE
PRICE!**

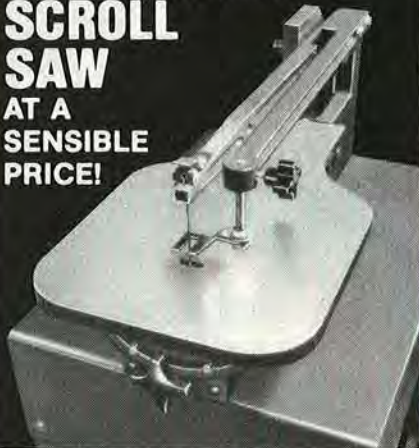

30-DAY FREE TRIAL!

Use this high-precision saw to make hundreds of profitable, unusual items... toys, name-bars, filigree work, clocks, holders... the list is nearly endless! Because the Model 1600 cuts so smoothly, sanding is virtually unnecessary!

The new Woodmaster Model 1600 gives you a big 16-in. throat capacity, 2-in. cutting depth, a generous, oversize worktable, ball-bearing drive... and much more! Made in U.S.A. **Easy Terms.**

Send today for free information kit!

Phone Toll Free 1-800-824-7888 Oper. 642

Woodmaster Tools, Dept. CW9
2908 Oak, Kansas City, MO 64108

Name _____
Address _____
City/State _____ Zip _____

**QUALITY
FOR
LESS**



Zip-Penn

QUALITY TOOLS AND REPLACEMENT PARTS

- Save Up To 35% Off Retail
- Complete Line of Chainsaws and Brushcutters
- Hard to Find Parts for Chainsaws, Lawnmowers and Small Engines
- Hand and Shop Tools
- Repair Manuals and Safety Equipment
- Over 23 Years Experience
- Full Money Back Guarantee

RUSH ME YOUR CATALOG!

NAME _____
ADDRESS _____
CITY _____
STATE _____ ZIP _____

MAIL TO: ZIP-PENN, DEPT. WOO-11
P.O. BOX 15129
SACRAMENTO, CA 95851

Quality By Design

PORTER+CABLE

Model 100

7/8 HP ROUTER

List \$194 SPECIAL \$87.95



Model 330

Speed-Bloc Finishing Sander

List \$87.50 SPECIAL \$56



Model 337

3" X 21" Belt Sander
with Dust Pickup

List \$181 SPECIAL \$115



ADD \$2.00 Shipping/Handling for each tool.

Model 141

14" Band Saw

Better By Design™

POWERMATIC III

3/4 HP 115V

1 Phase Motor w/Manual Switch

Regularly \$1273 SALE \$1085

F.O.B. Factory



Model 45

12" Lathe

3/4 HP 115V

1 Phase Motor with Magnetic Controls
and Safety Shield F.O.B. Factory

Regularly \$2167 SALE \$1890



Supplies Limited - N.Y.S Residents Add Sales Tax



BRADY SUPPLY CORP.

649 MADISON AVENUE

P.O. BOX 326

ELMIRA, NY 14902-0326

607-733-6591

Continued from page 20



Hole in one

The competition is keen among devices that will countersink for flathead screws and counterbore for wood plugs or putty. This set of Screw Diggers made by The Diston Co. adjusts more easily than some devices that require you to align up to four parts before tightening the collar. *Screw Diggers*. \$6.95 post-paid. Catalog #200-0120 from The Fine Tool Shops, 20 Backus Ave., P.O. Box 1262, Dept. W, Danbury, CT 06810.



Put a grip on your tools

If your shop is like ours, some tools have a tendency to slip from your hands and out the door. Plasti Dip, a product of PDI, Inc., can be dipped, sprayed, or brushed onto tool handles for a no-slip grip. The coating also helps metal to resist rust and corrosion. *Plasti Dip*. Available through retailers and catalogs. The suggested retail price of a 16-oz. can is \$7.75. Also available for \$4.98 in 9-oz. cans and for \$6.25 in 12-oz. aerosol spray cans. ■

Learn the Secrets of EXPERT WOODWORKING WITH HAND TOOLS
with Donn Fahnestock on Videocassette!



ONLY \$39.95 each
SAVE! \$69.95 Sets of two,
ORDER TOLL FREE 1-800-243-1037 In CT, 797-0772
VHS or Beta

One of woodworking's master teachers proves you don't need a shop full of expensive power tools to do magnificent work.

In a few hours with Donn Fahnestock you'll learn the experts' secrets of planing, jointing, finishing, sharpening, even carving – using just a few carefully selected hand tools. And if a picture is worth a thousand words, you'll find Donn's demonstrations worth a thousand hours of reading, studying plans and diagrams, and learning by trial and error!

4 complete lessons on each 60 minute videocassette!

How to Work with Hand Planes – The Bench Plane

- Choosing the right plane for smoothing, leveling, jointing and more
- Three key adjustments for better, faster, easier planing
- How to avoid "round ends" and other common planing errors
- Fine tuning your plane for a perfect shaving

How to Work With Hand Planes – The Specialty Planes

- Confused about Rabbet Planes? How to select the right one.
- Smoothing knots and erratic grains with the scraper
- Shortcuts to fast wood removal – spokeshave and drawknife
- 30 problems, one easy solution – the Combination Plane

How to Make Carcase Joints with Hand Tools

- Grooving – the key to easy, accurate assembly
- Making handsome raised panels with chisel and plane
- How to shape a perfect Dovetail Joint
- Chisel, saw and marking gauges are all the tools you need!

How to Make Framing Joints with Hand Tools

- Using dowels for quick, professional results
- The Half-Lap – strength and utility, made with a saw
- A great look with little effort – the Slot Mortise
- The easy way to cut a perfect mortise – with hand tools!

Return Policy: Defective tapes may be returned for exchange within 30 days.

CLIP AND MAIL TODAY!



The Fine Tool Shops, Inc.
Dept. WMN5
20 Backus Ave., Box 1262
Danbury, CT 06810

Send to _____

Address _____

City _____ State _____ Zip _____

Check enclosed Charge my

VISA AmExpress MasterCard

Account # _____

Exp. Date _____

Send your 76-page full color catalog of fine hand and power tools FREE with my order.

Qty	Title	Type	Price ea.	Total
	How to Work With Hand Planes – The Bench Plane	<input type="checkbox"/> VHS 602-0001 <input type="checkbox"/> Beta 602-0021	\$39.95	
	How to Work With Hand Planes – The Specialty Planes	<input type="checkbox"/> VHS 602-0002 <input type="checkbox"/> Beta 602-0022	\$39.95	
	How to Work With Hand Planes – (Both tapes above)	<input type="checkbox"/> VHS 602-0010 <input type="checkbox"/> Beta 602-0030	\$69.95	
	How to Make Carcase Joints with Hand Tools	<input type="checkbox"/> VHS 602-0004 <input type="checkbox"/> Beta 602-0024	\$39.95	
	How to Make Framing Joints with Hand Tools	<input type="checkbox"/> VHS 602-0003 <input type="checkbox"/> Beta 602-0023	\$39.95	
	How to Make Joints (Both tapes above)	<input type="checkbox"/> VHS 602-0011 <input type="checkbox"/> Beta 602-0031	\$69.95	
		Subtotal		
		Shipping & Handling (\$2.00 per tape)		
		CT 7½% Sales Tax		
		TOTAL enclosed		

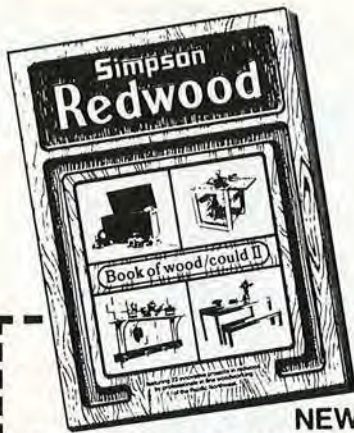

NEW
BOOK OF WOOD/COULD II
 featuring
23 REDWOOD PROJECTS

... created by professionals in fine woodwork-
 ing. Complete plans, working with wood tips,
 plus the fascinating story of redwood. \$3.95

Enclosed is \$3.95. Please send me a copy
 of the Redwood Book of Wood/Could II.
 (CA residents add 6% tax)

Name _____
 Address _____
 City _____
 State _____ Zip _____

Simpson

Simpson Timber Company, California Operations,
 P.O. Drawer V, Arcata, CA 95521 Dept. W-52



CONOVER

WOODCRAFT SPECIALTIES, INC.

18125 Madison Road • Parkman • Ohio • 44080
 216/548-3481



THE
CONOVER
16" LATHE
SET

Made in U.S.A.

With heavy cast iron construction,
 precision Timken roller bearings, a 16"
 swing, unlimited center distance and
 indexing to 12 positions; The Conover
 Lathe is suitable for heavy face plate
 turning (inboard and outboard), metal
 spinning, and spindle turning from
 chess pieces to porch posts.

The Conover Lathe Set is mounted
 on a wood bed which you build to any
 length. Package includes headstock;
 tail stock; tool rest; hold down bolts,
 washers and wheels; motor mount;
 accessories and complete instructions
 for just \$895.

OK Conover,

Enclosed is \$1 for your 16p
 catalogue detailing the Conover Lathe
 and your entire line of handmade
 tools.

Enclosed is \$2.50 for your
 catalogue, the lathe manual and a poster
 all sent 1st class.

Name _____
 Address _____
 City _____ State _____ Zip _____

Full Size Plans



Our Rocking Horse has a padded saddle &
 flowing mane. He's 36 x 25 and easily made
 from our full-size plan. **Plan-245..... \$7.00**



Toddlers love riding
 Charlie Horse. He is
 easily built with hand
 & power tools. Trailer
 is 11 x 22 x 26 high &
 easily built of pine.
Plan-335 \$4.50



Jib Crane swivels on
 ball bearings and has
 two working hand
 controls. Height 24"
Plan-319..... \$4.00



Our great collection of five toy vehicles is
 easily built with hand & power tools. Trailer
 is 18" long & 7" tall. **Plan-18004..... \$8.50**
 Add postage 50¢ per plan. NY Res. add tax.
 Catalog \$1.00—Free with plans. Phone (516) 462-6228
 We accept Visa & MasterCard orders if over \$15.00

ARMOR, Dept. L, Box 445, E. Northport, NY 11731

CALL US FOR QUOTATIONS
ON MACHINES & ACCESSORIES
BEFORE YOU BUY!



POWERMATIC Model No. 26 Shaper—
\$1,669.00 FOB McMinnville, TN
 with either #1260050 solid spindle or
 #1260010 interchangeable 1/2" or 3/4"
 spindles, complete with motor and control.

Miss. residents add 6% tax.

Special net prices
 Sale ends December 31, 1985
**FREUD carbide raised
 panel cutters.**

#EC-202 #EC-209
 #EC-210 #EC-211
 #EC-212 #EC-213

\$79.00 each Prepaid in U.S.A.

Call us for your special prices
 on other Freud blades and cutters.
 Call toll free 800-821-2750.
 In Miss. call 800-321-8107.
 Ask for Max, Bobby or Van.

Addkison
HARDWARE CO. INC.

126 E. Amite St., P.O. Box 102
 Jackson, MS 39205

"Jorgensen"
 AND **"Pony"**
CLAMPS

Dependable extra hands for all
 types of clamping and work-holding
 jobs: woodworking projects,
 home maintenance, and
 furniture repair.

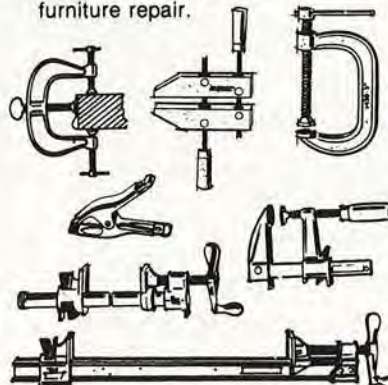

Write for FREE LITERATURE. For
 big 32-page "how-to-clamp-it"
 catalog, send 50¢.

ASK YOUR DEALER

ADJUSTABLE CLAMP COMPANY
 THE CLAMP FOLKS
 410 N. Ashland Ave./Chicago, IL 60622



PROJECT
PLANS



Over 300 projects are
 contained in these three
 idea-packed books, repre-
 senting the largest collection
 of Better Homes and Gardens
 project plans ever published.
 Nearly 400 pages of photos, dia-
 grams and instructions plus order forms for blue-
 prints of the more detailed projects. Each of these
 colorfully designed 128-page books focuses on a
 different area with plans for children, outdoors
 and home improvement projects.

from the pages of **Better Homes**
 and Gardens

Project Plans
 to Build for Children \$ 5.25
 Project Plans
 for Outdoor Living \$ 5.25
 Project Plans
 for All Around the House \$ 5.25
ALL THREE BOOKS ONLY \$12.95

FREE Furniture Kit Catalog — a \$3.50 value — when
 you order all three books.

All charges include shipping and handling. MasterCard
 and Visa accepted. No C.O.D.'s.

The Garlinghouse Company
 P.O. Box 299, Dept. 33046
 Topeka, KS 66601
 (913) 267-2490



Print this article

WOOD



Holiday Gift List

Just check the items you want, tear out this section and casually leave it where your family can find it. They'll get the hint!



The RIPSTRATE has revolutionized ripping on table and radial arm saws by keeping hands away from the blade. Holds work firmly against the fence and prevents kickbacks. Self adjusting. Over 10,000 in use by amateurs, professionals, schools, government and military installations. \$66. Check, Visa, M/C. Call toll free 1-800-421-0256. Free brochure. FISHER HILL PRODUCTS, 4A Fisher Hill, Fitzwilliam, NH 03447.



The Delta 16" motorized band saw features an innovative three-wheel design that delivers high capacity 16" blade-to-frame and 8" depth of cut capabilities. Features include: C-type cast-iron frame, adjustable 16" x 16" cast-iron table that tilts to 45°, ball bearing supported blade guides, blade tension scale, rip fence and miter gauge, removable safety switch. DELTA INTERNATIONAL MACHINERY CORP., 246 Alpha Drive, Pittsburgh, PA 15238. Call toll-free: 800-438-2486. In PA, 800-438-2487.



Put a perfect edge on any chisel or plane blade with this honing guide and water stone. Guide adjusts instantly to hold any blade, to 3 1/2" wide, at the correct honing angle. 1500 grit stone uses water, not oil, so cleanup is quick and easy. Each \$7.95 + p/h. (total \$9.95)—or save \$4.00 and order honing set #800-0100 at \$14.85 ppd. From FINE TOOL SHOPS, Dept. WMGG, 20 Backus Ave., Box 1262, Danbury, CT 06810.



Cut the most intricate patterns in wood, plastics, light metals, etc. Just add your own 1/4 hp electric motor to an Excalibur II, and start cutting! \$495 US. Includes 72 blades, wrenches, and manual. Try it for 30 days. You must be satisfied, or purchase price refunded. In the U.S., call toll-free 1-800-387-9789, in Canada call collect 416-293-8624. J. PHILIP HUMFREY INTERNATIONAL, 3241 Kennedy Road, Unit 7, Scarborough, Ontario, M1V 2J9.



Campbell Hausfeld® Road Pal—the new, emergency car air compressor that's 3 tools in 1! Plug it into your vehicle's cigarette lighter and you've got an air compressor, a handy in-car spotlight, or an amber emergency light. Inflates tires in less than 6-minutes! RP1000 \$29.75 ppd. in USA. MC/Visa accepted. Phone toll-free 800-821-2750; in Miss. 800-321-8107. ADDKISON HARDWARE CO., P.O. Box 102, Jackson, MS 39205.



These easy-to-assemble pre-cut marquetry kits include instructions, pre-cut adhesive backed veneers, veneer tape, sandpaper, board core, and picture hooks. All you need is an iron to laminate the face—NO GLUES NEEDED! 30 beautiful designs available for your home decor. Prices range from \$10.99 to \$36.99. ARTISTRY IN VENEERS, INC., 450 Oak Tree Avenue, S. Plainfield, NJ 07080. 201-668-1430.



Free! \$18.95 hardwood parts organizer with the purchase of our woodworking or toymaking parts selections. To receive hundreds of the most needed woodworking or toymaking parts, send \$47.95 ppd. and receive the \$18.95 organizer free! Parts in both organizers are below prices in our catalog. Please specify toy or wood parts selections. CHERRY TREE TOYS, INC., P.O. Box 369-309, Belmont, OH 43718. Catalog \$1.



A new clamp for woodworkers! The "Merle" clamp forces your project into square. Fully adjustable from 2 5/8" x 2 5/8" to 36" x 36". Excellent for clamping picture frames, cabinets or anything which requires 90° corner clamping. Industrial quality tool made of cast aluminum and steel. \$34.95, MC/Visa. INDUSTRIAL ABRASIVES, P.O. Box 8611, Reading, PA 19603. Toll free 1-800-428-2222. In PA 1-800-222-2292.

WOOD

Holiday Gift List



Crafted of 1" thick solid walnut, the clock body is pre-sanded and milled for the movement recess. No tolls or experience are needed for assembly; simply attach the movement and numerals and apply the finish of your choice. 11" diameter. 30 day money-back guarantee. CASKER CO., Box 2347, Cincinnati, OH 45201.



This perfectly scaled-down version of an Ulmia continental bow saw is being made exclusively for Woodcraft by Georg Ott in West Germany. The 13 3/4" miter box holds the bread for cutting and includes 90° and 45° slots for accurate work. Made of lacquered European red beech. \$29.95 ppd. Order #02A40-O. 32-page woodworking catalog free on request. WOODCRAFT SUPPLY CORP., 41 Atlantic Ave., P.O. Box 4000, Dept. WBHC85, Woburn, MA 01888.



Handy as a pocket on a shirt! Sturdy, ball-bearing roller, 14" x 2" diameter, swivels 360°; telescoping steel stand adjusts 21 1/2" to 48". Model 314 Extension Roller... \$35 ppd. from WOODMASTER TOOLS, INC., 2908 Oak, Kansas City, MO 64108.



These chisels are special because they're from Freud. Made from chrome vanadium steel for the utmost in edge holding, the handles are select boxwood for durability and comfort. Overall length is about 10" and the handles are about 5" long. WC-104 4 pc chisel set on sale for \$24.95; WC-110 10 pc chisel set on sale for \$49.95. Free catalog with each order. WOODWORKERS SUPPLY OF NEW MEXICO, 5604 Alameda N.E., Albuquerque, NM 87113. 1-800-645-9292.

WOODWORKING ASSOCIATION OF NORTH AMERICA

An ideal holiday gift for any woodworker, rugged natural canvas shop apron printed in brown with dual pockets for tape measure, screws, nails, tools and odds 'n' ends. Essential for protecting clothing from shop splatters, stains and dirt. \$10 ppd. WOODWORKING ASSOCIATION OF NORTH AMERICA, P.O. Box 706, Plymouth, NH 03264.



Freud handtools are made of the finest chrome vanadium steel with boxwood handles. They come in an assortment of selections with their own box jointed wooden cases. The perfect gift for the woodworker. Call 800-334-4107 for your nearest distributor.



If you enjoy woodworking, *The American Woodworker* is for you. Published quarterly, \$10.00 per year or \$18.00 for two years; foreign \$14.00 per year or \$22.00 for two years, U.S. funds only. Subscribe for two years and receive the current issue free. Satisfaction guaranteed or your money refunded on unmailed copies with the free issue yours to keep. Ck or m/o to THE AMERICAN WOODWORKER, P.O. Box 1408, Dept. WH, Hendersonville, TN 37077-1408.



New router jig makes short work of small-scale mortise and tenon joinery. Use with any router, a 1/4" straight bit, and a 7/16" guide bushing. Quick set-up for 90° joints enables tandem or side-by-side mortises and angled joints. Mortises will be 1 3/16" long by slightly over 3/8" wide. Tenons may be cut 1/2", 3/4", or 1" long. The mortise works on 3/4" or thicker stock and 1 1/2" minimum stock width. \$49.95 postpaid. HIGHLAND HARDWARE, 1045 N. Highland Ave., NE, Atlanta, GA 30306.



No longer will he have an excuse for not completing projects because he doesn't have a lathe. Conover's 16" Lathe Set features a heavy duty lathe with unlimited center length at an affordable price. Our catalogue of unique tools and machinery, \$1. CONOVER WOOD CRAFT SPECIALTIES, INC., 18125 Madison Road, Parkman, OH 44080. 216-548-3481.



A brand new planer, the "Plane Jane" by Ryobi, weighs only 58 pounds and measures 19 1/4" L x 16 3/4" W x 14 1/4" H. Planes material up to 10" wide and 5" thick and features all-ball bearing construction and externally accessible brushes. Standard accessories include 10" blades, a blade adjustment gauge, adjustment tools, extension rollers and owner's manual. \$659. RYOBI AMERICA CORP., 1158 Tower Ln., Bensenville, IL 60106. 312-766-1621.



Porter-Cable Model #330 Speed Bloc Finishing Sander, the original industrial quality palm sander, specially priced at \$55.95 ppd! Also model #505, \$105.95 ppd! R.A. Ness & Co., THE WOODWORKERS EMPORIUM, 8888 N. Milwaukee Ave., Niles, IL 60648. 312-824-0565.



The Makita finishing sander, originally \$79.00 is on sale for \$43.00, from Tools on Sale™, a division of SEVEN CORNER ACE HARDWARE, 216 West Seventh St., St. Paul, MN 55102. 1-800-328-0457.



Build your own grandfather clock with an Emperor do-it-yourself kit. Parts are pre-cut with easy-to-follow instructions supplied. Solid 3/4" black walnut, cherry, oak. Solid brass West German chiming movements and dials are available. Buy direct from Emperor's factory and save! For FREE color catalog, write EMPEROR CLOCK COMPANY, Emperor Industrial Park, Fairhope, AL 36532.



Never before possible! A professional wheel maker that allows you to quickly mass produce detailed, quality wooden wheels at a low cost. Makes wheels from 1 1/2" to 4 1/2". All sizes, fully adjustable. Also turn out rosettes and yo yo's. \$59.95 + \$2.00 s/h. THE TOOL COMPANY, 1306-G South Commercial, P.O. Box 629, Dept. BHG-CH, Harrisonville, MO 64701. 816-884-2679.

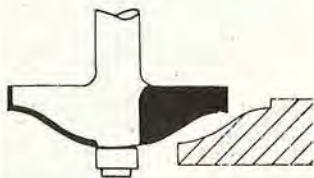

Make beautiful raised panels for doors. Two flute, high quality tungsten carbide tips. One piece construction, 2 1/4" large diameter, 1/2" ball bearing pilot and 1/2" diameter shank. Bit # 157 for \$38.00. MLCS LTD., Box 53D, Rydal, PA 19046. MC/Visa. Call toll free 1-800-523-2445, Ext. 56 (in PA 1-800-346-7511, Ext. 56).



Sturdy, dependable woodworking power tools assembled with quality metal parts and wood frame. Kits contain all metal parts including screws and bolts. All GIL-BILT metal parts are guaranteed for five full years against mechanical failure caused by defect. Manufactured and sold by mail order for 39 years. Order direct from factory. GILLIOM MANUFACTURING, INC., 1700 Scherer Parkway, St. Charles, MO 63301. 314-724-1812.



THE FINE TOOL JOURNAL

"The Fine Tool Journal" is must reading for the antique tool collector. Published 10 times a year, the Journal offers insight on the latest prices and hottest auctions. Tools are identified and their history discussed. One year subscription \$10.00. Sample copy \$1.50. FINE TOOL JOURNAL, RD #2, Dept. W, Poultney, VT 05764.



Flush mount pictures, hang shelves, cabinets and more. This unique bit cuts a key-hole-shaped slot eliminating the need for hardware or picture wire. Handy 1/4" shank bit cuts 3/8" keyhole made of high speed steel for long life and only costs \$8.50. Order MLCS LTD., Box 53D, Rydal, PA 19046. MC/Visa. Toll free 1-800-523-2445, Ext. 56 (in PA 1-800-346-7511, Ext. 56).



Make your own Christmas gifts easily! The Ethan Clock Kit is one of the newest members of the Craft Collection. Standing 6" tall, this solid cherry kit can be assembled in less than an hour! Includes pre-assembled, ultra-accurate quartz movement, dial and instructions. Only \$24.45 ppd. MC/V CRAFT PRODUCTS, Dept. BH5N, 2200 Dean St., St. Charles, IL 60174. 312-584-9600.

"WOODWORKING" By Ian Kirby

An English master gives you an apprenticeship in his shop. A complete reference and tutorial series of 12 books each with audio tapes. First book and tape now available, regular price \$19.95 series preview offer only \$9.95. Call 1-800-LIGNUM-1 or write to LIGNUM PRESS, P.O. Box 900217, Atlanta, GA 30329.

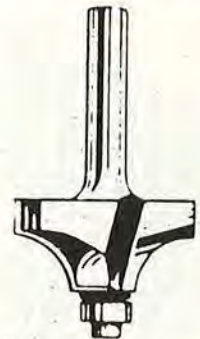

Make rounded edges or rounded corners with decorative bead. Two flute, high quality tungsten carbide tips. One piece construction with 1/2" ball bearing pilot. 1/4"-3/4" radius with 1/4"-1/2" shank, \$15-\$29. MLCS LTD., Box 53D, Rydal, PA 19046.



This all steel unit provides support for your workpiece at all times. Height adjusts at any machine, then folds and latches closed. Unique design allows micrometer height adjustments made with one hand. 15" w x 66" l. Folds to 5" deep. Rollers are galvanized and ball bearing. Model HRT-68 w/9 rollers (8" apart) \$175 or HRT-70 w/17 rollers (4" apart) \$214 + UPS. HTC PRODUCTS, INC., Toll free 1-800-624-2027 (In Mich.) 313-399-6185.

WOOD

Holiday Gift List



FREUD 10 piece chisel set— $\frac{1}{4}$ " to $\frac{1}{2}$ " of premium chrome vanadium steel. Hardness of 58-60 Rc. The most tool for the money. Boxwood wooden handles bound by double-steel hoops for strength and durability. Packaged in a fitted box-jointed wooden case. \$50.00 includes s/h. BRADY SUPPLY CORP., P.O. Box 326, Elmira, NY 14902.



Make beautiful raised panels of professional quality. Two flute thick, high quality tungsten carbide tips, this bit makes raised panels for doors and great looking drawer fronts. One piece construction complete with $\frac{1}{2}$ " ball bearing pilot, and $\frac{1}{4}$ " diameter shank. Bit # 15, \$25.00. MLCS LTD, P.O. Box 53D, Rydal, PA 19046. MC/Visa. Call toll free 1-800-523-2445, Ext. 56 (in PA 1-800-346-7511, Ext. 56).



The Hegner Hobbymax, from Hegner's family of precision scroll saws, is ideal for the miniaturist, hobbyist, or model-maker. Smooth, square cuts without sanding, no vibration and rarely a broken blade are what make Hegner saws a joy to use and own. A special gift for a special someone, and it's under \$500. Free information. AMI, P.O. Box 312, New Castle, DE 19720.



SHOPHELPER™ SAFETY GUIDES, a totally interchangeable system for controlling stock on saws, shapers and other stationary tools. Single direction bearings guard against kickback and provide smooth, even cutting. Additional mounting brackets allow quick easy interchangeability of guides on machinery. Set, complete with brackets, \$79.50. See your local dealer or call: 800-828-8833.



Sound woodworking lies in tools you can trust. The pride and care with which these tools are crafted is evidenced by the incredible attention to detail and the use of only the finest materials. Guaranteed square within .002" over the length of the blade. #120-090 Master try square (8" blade), \$47.00; #120-091 Jointmaker's Square (5" blade), \$32.00. Free catalog with each order. WOODWORKERS SUPPLY OF NEW MEXICO, 5604 Alameda N.E., Albuquerque, NM 87113. 1-800-645-9292.

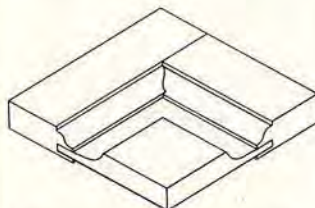

The original Ogee DOOR SHOP™ as featured in WOOD MAGAZINE MAY/JUNE 85) is complete with style and rail, slot and panel raising bits for the $\frac{1}{4}$ " chuck router. Bits are carbide tipped and BB and will make $\frac{3}{4}$ "- $2\frac{1}{4}$ " thick raised panel doors, \$89.50 ppd. ZAC PRODUCTS INC., 533 West 34 St., NY, NY 10001. Call 800-441-0101.



Like a third hand. Provides that extra support so often needed. Its rugged, heavy-duty, all steel construction makes it a tool you'll depend on for years. Roller is 13" long, galvanized and ball bearing. Adjusts in height from $25\frac{3}{4}$ " to 45". When you're done, it folds flat. #HPR-13 \$39.95 + UPS. HTC PRODUCTS, INC., Toll free 1-800-624-2027 (In Mich.) 313-399-6185.



Excellent quality carbide-tipped $\frac{1}{2}$ " and $\frac{1}{4}$ " shank router bits are offered at reasonable prices. Featured are carbide-tipped 6-pc. cabinet sets for \$149.95, shaper cutters from \$20 and a 3-pc. panel raising set for $\frac{1}{2}$ " routers at \$149.95. For more information call 206-236-0272 seven days a week between 10 am and 7 pm. CASCADE PRECISION TOOL CO., Box 848, Mercer Island, WA 98040.



The Woodworkers Organizer Unit comes complete with over 1,000 wood parts. Screwhole buttons, wheels, pegs, plugs, glue pins and plastic bins, \$31.95 ppd. in USA. TIMBERS COUNTRY STORE, Carnelian Bay, CA 95711-0850. Catalog of wood specialties, \$1, free with order.



Combination pocket knife and precision ruler. A very slim, two-bladed knife in a polished stainless steel case together with a 6" folding precision ruler graduated in 64ths. Overall size $3" \times \frac{5}{8}"$ closed. Weighs only a few ounces. A wonderful gift. \$29.90 ppd. GARRETT WADE CO., 161 Ave. of the Americas, New York, NY 10013.

Algonquin Indians of the southern Mississippi River basin region believed the pecan tree embodied the Great Spirit—perhaps because this one species provided so many of life's essentials. Pecan, a member of the hickory family, furnished nuts for eating, oil for cooking, and wood for implements and fuel. Pioneers, introduced to its bounty by the Indians, named this tree in honor of the Algonquin chief Peccan.

A North American native, pecan has been traced to the cretaceous period of 130 million years ago. Fossils found in Oregon and Washington prove that pecan was growing while dinosaurs roamed in what was then a much-warmer climate.

Once cherished for dining and living room furniture, pecan is now valued far more for its annual nut crop than its wood.

Wood identification

Belonging to the genus *Carya*, which accounts for approximately 22 hickory species throughout North America, pecan is often cut, graded, and marketed simply as hickory.

Pecan (*Carya illinoensis*), however, has a warmer, pink-tinted tone than does hickory. Its heartwood ranges from light to medium-tan in color and the sapwood tends to be cream-colored. "Pecky" pecan, showing the dark swirls and spots of limb buds and boring beetles, warrants special attention. With a tight, close grain, pecan wood may often show a pronounced wavy figure.

In forest habitat, pecan

PECAN

the 'great spirit' hickory



Pecan



Pecan lumber

Pecan-veneered plywood

Pecky pecan

rarely reaches 100' in height. Growing in the open, or in orchards, pecan trees may achieve 160'; but will have shorter, divided trunks with many upreaching branches (the better to bear nuts).

Working properties

If you've used hard maple successfully, you'll have no problem working pecan. The wood has remarkable strength, hardness, elasticity, and shock

resistance—qualities some woods claim individually but that combine only in pecan. Because pecan possesses this all-around toughness, it can't easily be worked with hand tools—carbide-tipped cutters on power tools become a necessity.

While pecan shrinks considerably during drying, it remains fairly stable once seasoned. When dry, pecan weighs 42–52 lbs. per cubic foot.

Pecan bends with little effort and glues well, but its tendency to split necessitates pilot holes for screws and nails. The hardness of pecan translates into a wood that can be brought to a mirror-like finish.

Uses in woodworking

While 80 percent of all hickory goes for tool handles and rugged farm implement parts, pecan wood becomes quality office desks and chairs. It also finds its way into home wall paneling and commercial architectural veneers. For long-wearing chair parts—legs, backs, and rungs—pecan may be unequalled.

Cost and availability

Some large hardwood suppliers label pecan specifically. When it's mixed with hickory, you have to sort to find the pecan.

Pecan is available in boards up to 8" wide and 8' long. Pecan veneers are widely offered, too, but pecan-faced plywood may be harder to find.

You can buy pecan fairly inexpensively. A board foot of pecan can be purchased for about half the cost of the same amount of red oak, for instance, a fact that reflects pecan's diminished popularity as a furniture wood.

Sources of supply

Pecan grows primarily from southern Indiana southwestward into Texas. However, it has been successfully introduced into other mild-climate areas (Florida and Georgia, for instance) for its nut crop. ■

Photographs: Bob Calmer
Illustration: Steve Schindler



For several months each year, the partners in Unicorn Strings relive the Renaissance, playing and selling their version of an age-old musical instrument.

A RENAISSANCE FOR HANDCRAFTED PSALTERIES

David Beede, 31, in center of photo at left, began handcrafting bowed psalteries simply because he loved to play them. Wood craftsman Gene Jaeger, 41, at right in photo, introduced his production know-how to the effort. And Jessica Jaeger, 40, Gene's wife, seated, added her talents for building and selling. Operating as Unicorn Strings, the three work much of the year in their rural Gainesville, Florida shop to make the unique folk instrument that they sell at annual Renaissance festivals. On the road from August through October together, then sharing shop space back home, these three from differing backgrounds have melded into an inseparable team that benefits from their multitude of talents.

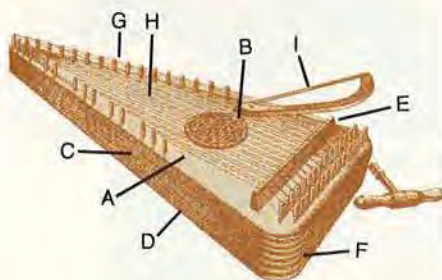

On a bowed psaltery, primarily a melody instrument, the natural notes are on the right as it points away from you, the sharps and flats on the left. If you were to disassemble the \$165 model above, here's what you would find (refer to outline drawing): (A) $\frac{1}{4}$ " quarter-sawn sitka spruce soundboard; (B) sound hole with hand-carved cherry rosette insert; (C) $\frac{13}{16}$ " cherry sides; (D) $\frac{1}{8}$ " birch aircraft plywood back; (E) cherry string bridge; (F) $\frac{6}{4}$ laminated hard maple pin block; (G) pin posts of nickel-plated steel; (H) light E-type steel guitar strings; and (I) curved cherry bow with polymer strings. At one side lies the tuning wrench.



Twelve miles north of Gainesville, down a rutted, sandy road gouged from the pine and live oak, a 12 x 55' mobile home seems to slouch on its site.

Somewhat aged and bent, its sheen long departed, the structure looks much like others in the north Florida backcountry. The Spanish moss brushing the roof, the outbuilding held erect only by its contents, and the scraggly cabbage palms poking out of the lush surrounding underbrush, betray little of the contemporary setting within.

Inside, a workshop glistens in hospital-like cleanliness. The walls and ceiling, painted white, brighten with the accent of yellow compressed air lines coiling on their way to designated work stations. Orderly stacks of wooden parts, rows of clamping fixtures, and a hardware-store arrangement of pins, finishes, and oddments mock the rural clutter outside.

Here, the bowed psalteries made by Unicorn Strings take shape. Glued and clamped, routed to form, drilled, sanded, finished, and pegged for strings, this revived version of an ancient instrument is readied for faraway Minnesota, Texas, and other places where Renaissance festivalgoers may likely buy them.

Selling psalteries at Renaissance fairs

Renaissance festivals, reenactments of fairs mimicking the atmosphere of 15th-century Europe, have proved the perfect backdrop for the bowed psalteries designed and made by David Beede and Gene and Jessica Jaeger. The bowed psaltery was a product of the flowering of art, music, literature, and science marking the end of the medieval period. Some say the bowed psaltery came from Germany; some cite tiny Estonia as its country of origin. Wherever it came from, the psaltery—with its resonant, slightly ethereal and haunting sound—fits Renaissance regalia.

David, Gene, and Jessica don bright medieval merchant costumes for these gala events and trick their tongues into Middle English speech for selling their wares—requirements set by show sponsors to fully carry out the theme. As David observes, "Renaissance festivals are like a stage—a three-dimensional one into which the audience walks."

Gene believes fairs of this type fit the instrument perfectly. "It's an ideal environment. Customers know what the Renaissance is, they know what to expect, and the instrument looks right in it."

That's why Renaissance festival visitors have become the prime market for bowed psalteries. The three partners participate in two major fairs each year—the Minnesota Renaissance Festival in Shakopee and the Texas Renaissance Fair near Houston. Each runs for seven consecutive weekends near the end of summer, and scheduling happens back-to-back, so David, Gene, and Jessica make their home on the road for 14 straight weeks. Fairs close to home in Largo and Sarasota, Florida, round out their schedule.

With the festival circuit completed by fall's end, the team returns to Gainesville and begins manufacturing instruments to fulfill orders in hand, expected holiday orders, and stock for next season. During this off season, they'll often put in 40-hour weeks building psalteries.

How Unicorn Strings came to be

Like the Renaissance, which heralded a new era, the Unicorn Strings partnership of David, Gene, and Jessica began a satisfying lifestyle and change from the past for each of them. Bowed psalteries, and the fine-tuned technique of making and selling them, first drew the three together and now holds them in place. As David remarks: "We're like a three-legged stool—it wouldn't work without all of us."

David, experienced in wood, tools, and custom craftsmanship, says the only thing he lacked was a sense of efficiency before meeting Gene five years ago. David also knew folk music thoroughly and

Continued

CRAFTSMAN CLOSE-UP

had built his first instrument, a banjo, when he was 18 years old. Prior to the formation of Unicorn Strings, David listed among his pursuits rehabilitation counseling, playing dulcimer, teaching dulcimer, building dulcimers and other instruments (on custom order, an instrument might take him one month to make), and singing folk music. He had discovered the psaltery at a dulcimer festival, where he took measurements to build his first one. Then, he worked to perfect it until the present instrument evolved.

Gene Jaeger's background in design and carpentry, a stint as a shipwright, and a flair for production presented to David the opportunity to build bowed psalteries—lots of them. Says David: "When I met Gene, he said we could build 50, and I said it would take years to sell that many."

Jessica became a full-time partner in the enterprise after demand for the instruments picked up. The daughter of professional designer-craftspeople, Jessica knew her way around a wood shop, but had been working in adolescent drug prevention to help with finances. She began as the business manager; now she sands, drills pin holes, and matches woods.

Besides their shop skills, all three have sales talents, too. David relates to potential buyers, who may be musicians or play other instruments.

Gene, who had to quickly learn the first line of "Greensleeves" on the psaltery just prior to their first fair, has the nerve to urge people to play. And Jessica, with her counseling experience, relates well to the disabled and enjoys children.

The cottage-industry approach to production

"As the Unicorn name implies, bowed psalteries are somewhat unique," David notes. "But in the Middle Ages, there *were* unicorns. Goats' horns, for instance, were surgically grafted to form one. These animals assumed leadership of their herds and were much sought after. Hopefully, this leadership and



Gene assembles the instrument body by mounting the top, sides, and back in a two-piece clamping fixture. He spreads Titebond on the parts with a small paint roller, then bolts the halves together.

Routing the outside of the instrument leaves a smooth surface requiring relatively little sanding. David does any necessary sanding on the soundboard and sides under the light of an incandescent bulb, which produces more shadow to detect rough spots. Note the air hose for blowing dust.

Stringing and tying off 30 steel wires to the pins happens to be a job Jessica likes. After stringing, the psalteries are tuned with help from an electronic keyboard.



uniqueness applies to the instruments we make."

Most folk instruments, according to David, are naturally individual. "They're not only played by ear, but built by ear." When David built them by himself, that's how his instruments were made.

Now, in the mobile home workshop outside Gainesville, psalteries have become production instruments. Not in the factory sense of building without care or feeling, but in the cottage-industry sense of building with quality while reducing wasted effort and time-consuming hand labor where possible.

Following their credo—"Jigs make precision instruments"—they have geared up the production effort. Once ripped, and power-planed to thickness in a small outbuilding, psaltery parts pass into the main workshop for assembly and finishing. From gluing and clamping the psalteries together in two-part forms, to shaping the instruments on the router table, then drilling the soundhole and string pin holes, the three use various jigs and fixtures that ensure precision. The hand-built quality of custom work remains, but many formerly laborious tasks have been reduced or eliminated.

Finishing for perfect sound

Sanding and finishing, the all-important steps many woodworkers dread, must be impeccable on a psaltery. "The surface is where the instrument meets the public," David states, "but that doesn't necessarily mean lots of sanding. If you can cut it smooth, do it, so you don't have to abrade wood. "That's what he does in the workshop with a 2-hp. router mounted in a table and fitted with a large bit specially machined from a hand plane blade to take $\frac{1}{16}$ " off the edges of the instrument body after it's glued up. The sharply cut surface requires only minimal sanding.

Finishing psalteries, and other stringed wooden instruments, differs from other woodworking projects. The old adage "what you do to one side you have to do to the other"

doesn't apply. According to Gene, "finishing both sides has never been the case with musical instruments. You can't finish the inside, because the wood needs to breathe in order to remain flexible."

On a psaltery, for instance, the soundboard (top piece) must vibrate to produce sound: the string first vibrates when touched by the bow, which in turn vibrates the bridge. Then, the bridge vibrates the soundboard. "A smooth, hard finish on the soundboard gives a brighter sound," Gene advises. Too many coats would cause it to stiffen. Likewise, a penetrating oil would dull the sound by affecting the resonance of the wood. Moisture, he says, can't be sealed out by finishing the inside; it has to work its way in and out of the wood slowly through the soundhole. Movement of the wood is restricted by the instrument structure, which is built to withstand the more than 450 pounds of force the strings exert down its length. Gene adds that in the five years they've been making and selling psalteries, only one has been returned.

Adhering to these finishing principles, David sprays each psaltery with two coats of Rudd commercial lacquer before attaching the cherry string bridge. Then, he uses Watco oil on the bridge. Why not lacquer, too? "Because the strings would dent a surface finish like lacquer, eventually affecting their vibrating ability," David replies.

The perfect finish, like many of the techniques the three have developed, resulted from trial and error. "We first tried a coat of sanding sealer on the instruments, then a final coat of lacquer," notes Gene, "but two coats of spray lacquer turned out to be easier and more durable." With their production orientation, the lacquer comes from three-gallon pressure pots rather than the smaller siphon cup normally used with a spray gun.

Continually refining the product

"Sometimes," David tells us, "a concept comes to Gene, Jessica, or I

that revolutionizes our whole approach." Take the cherry used to construct the psaltery sides, for example.

At first, they purchased 4/4 stock from a nearby country sawmill. Ungraded, the wood received ranged from top quality to common and below—"real run-of-the-mill," as Jessica describes it. Despite the wood's low cost, they found they were actually losing money because of all the waste in unsound knots, cracks, and splits. Now, they buy quality FAS cherry from a northern supplier.

The hard maple once used for the pin blocks was another learning experience. Even strong, solid maple they knew would split under string tension after 30 pin block holes were drilled. So, instead of solid stock, they turned to laminated maple available from a manufacturer of piano parts.

David can laugh about another experience now, but his initial bow assembly method was truly frustrating. "I used 30 horse hairs in the bow 'string' and tried to slip them into the holes at each end as a group, but a few never made it. I'd spend a long time trying to poke through the strays," David recalls.

Now, the bow strings have entered the modern world—they're presently made from strands of polymer to resist shrinking and stretching from humidity changes and inserted as a unit.

Changes such as these have not only improved product quality, they have lowered production time and removed frustration from David, Gene, and Jessica's workshop hours.

Gene, always seeking more efficient methods, doesn't want to substitute machines for craftsmanship no matter how much time they save. He summarizes his and his partners' philosophy this way: "We are woodworkers rather than business managers, so our choice is to stay small and efficient. Then, we can continue to do the work ourselves." ■

Produced by Peter J. Stephano
Photographs: Wm. Hopkins, Jr.
Illustration: Jim Stevenson

HARD MAPLE WOODWORKER'S MALLETS

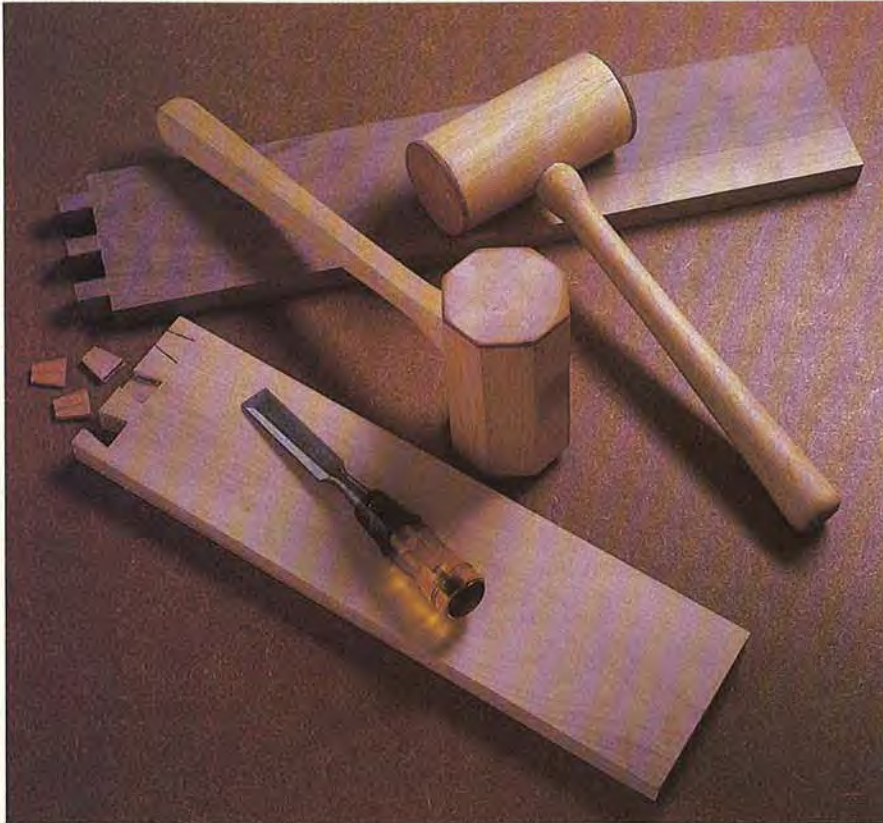

It's no accident that skilled woodworkers everywhere count a wooden mallet as one of their most trusted tools. It has literally dozens of uses in the shop—from nudging home a tight-fitting joint to driving a chisel, and lots of things in between.

Both of our custom mallets feature large leather-protected striking surfaces that dampen and diffuse contact over a large area. We show you how to fashion the version with the octagonally shaped head using a table saw and a few hand tools. The other, a design alternative if you like lathe work, closely resembles the first in construction. Refer to the Lathe-Turned Mallet Drawing, *below*, as your guide if you choose this variation.

Note: You'll need thick stock for the mallet heads and handles. You can either laminate thinner stock to size or purchase turning squares. See the Buying Guide for details.

1 Rip the mallet head (A) to $2\frac{3}{4} \times 2\frac{3}{4}$ " and crosscut it to length. Find and mark the center point of one of its edge-grain sides. Using a 1" spade bit, bore a hole into the head at the center point, stopping when the point of the bit just protrudes through the opposite side. Turn the piece over and finish boring the hole (doing this prevents chip-out).

2 Carefully chisel the hole in the mallet head to form a $1\frac{1}{4} \times 1$ " rectangle, working from both sides to avoid chip-out.

3 To transform the square stock into the octagonal shape, first tilt the blade on your table saw to 45° and set the fence $2\frac{15}{16}$ " away from the base of the blade as shown in

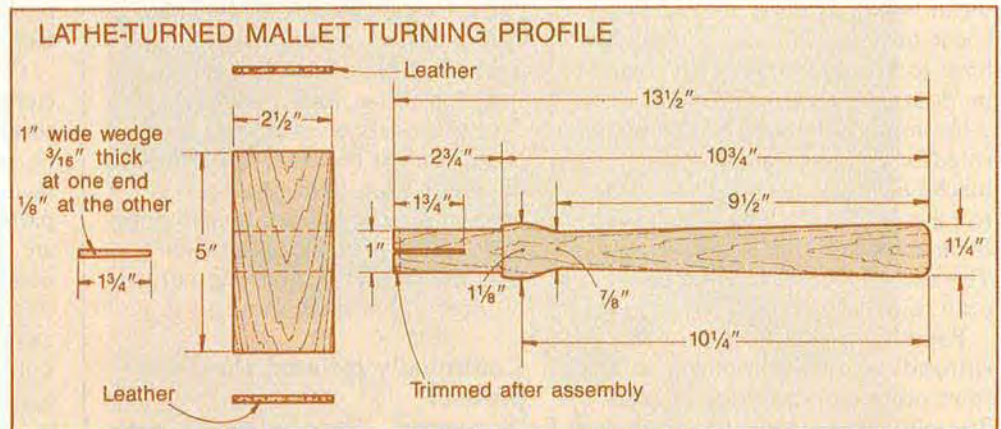

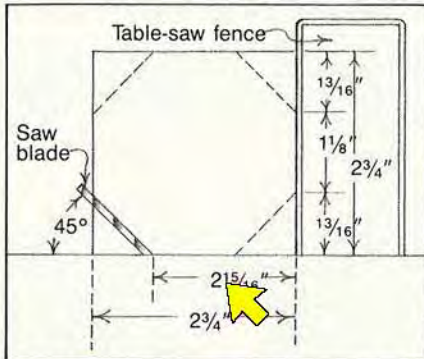

the drawing, *above*. Then, using a push stick, feed the stock along the fence and bevel-rip the edges.

4 Chamfer the edges of one end of the mallet head (the other end will be covered with leather and should not be chamfered).

5 Rip and crosscut the handle (B) to size. Cut a pair of $\frac{1}{8}$ " deep recesses 3" long to form the handle tenon as shown in the Octagonal-Head Mallet Drawing. (We used a

table saw, miter gauge and a dado blade to make the pair of recess cuts.) Make sure the handle tenon fits snugly in the hole in the mallet head. With a band saw or jigsaw, cut the handle to shape as indicated in the drawing. Then, use a spokeshave or scraper to make bevel cuts on the edges of the handle as shown in the photo, *below*.



6 With a fine-toothed hand saw or a band saw, cut a $\frac{1}{8}$ " slot 2" long to house the tenon wedge in the recessed end of the handle.

7 Fashion a wedge (C) from scrap maple. Then spread glue on the tenon and in the hole in the mallet head, and insert the handle into the hole. Now, run a few beads of glue into the slot in the handle,

cover the wedge with glue, and tap the wedge snugly into position (this will be the last time you'll have to use a hammer for this type of operation!). Remove the excess glue, and, after the glue dries, carefully saw off the excess material protruding through the head.

8 Finish-sand the entire mallet. Then epoxy and clamp the leather in place *opposite* the chamfered end. When the epoxy dries, trim the leather flush with the edges of the head with an X-acto knife. Finish the mallet with tung oil followed by a couple applications of paste wax.

BUYING GUIDE

● **Turning squares.** Maple $1\frac{1}{2} \times 1\frac{1}{2}$ " (18" piece required), \$1.05; 3×3 " (12" piece), \$3.10. Constantine, 2050 Eastchester Rd., Bronx, NY 10461 (or order toll-free 800-223-8087).

● **Leather.** $3\frac{1}{2}$ " leather Rounders, 35 cents each. Tandy stock #4126. Call 800-433-5546 for the store nearest you, or write Tandy Leather Company, P.O. Box 2934, Fort Worth, TX 76113. ■

Project Designs: Jim Boelling
Photographs: Hopkins Associates
Illustrations: Bill Zaun

Bill of Materials					
Part	Finished Size*			Material	Qty.
	T	W	L		
A	2 $\frac{3}{4}$ "	2 $\frac{3}{4}$ "	5"	maple	1
B	1 $\frac{1}{4}$ "	1 $\frac{1}{4}$ "	13 $\frac{1}{2}$ "	maple	1
C	$\frac{3}{16}$ "	1"	2"	maple	1

Supplies: epoxy, tung oil, paste wax, leather

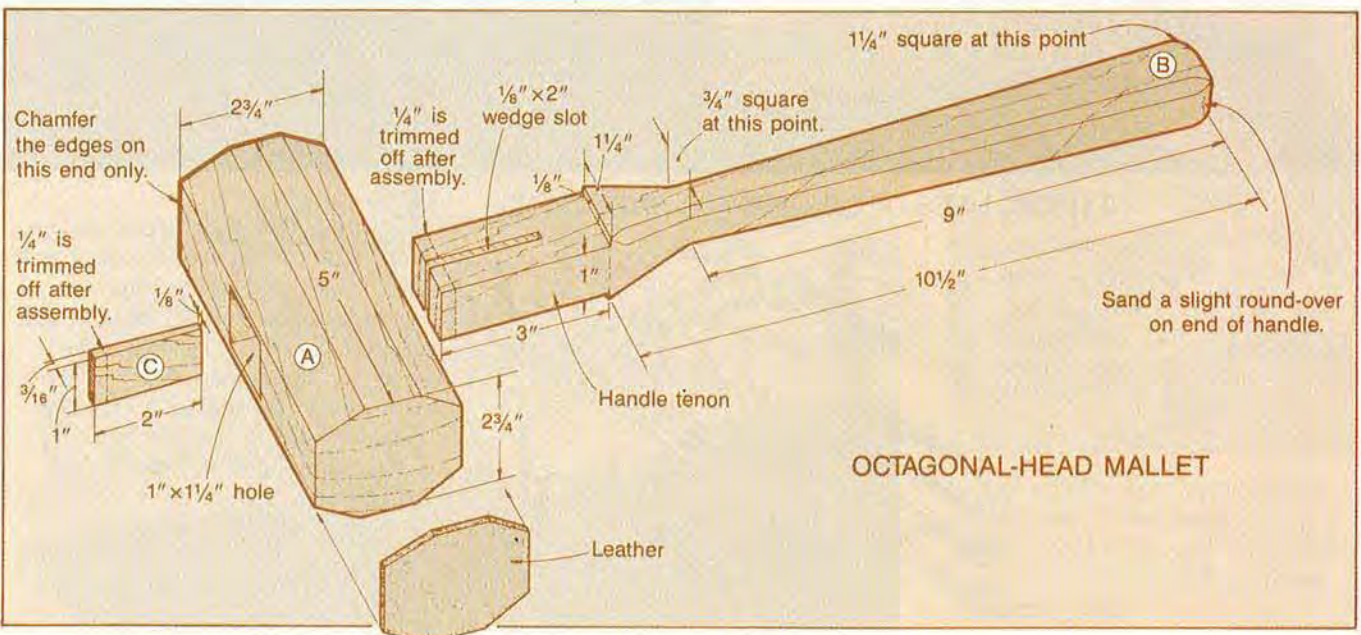

HOW TO BEND LAMINATED WOOD

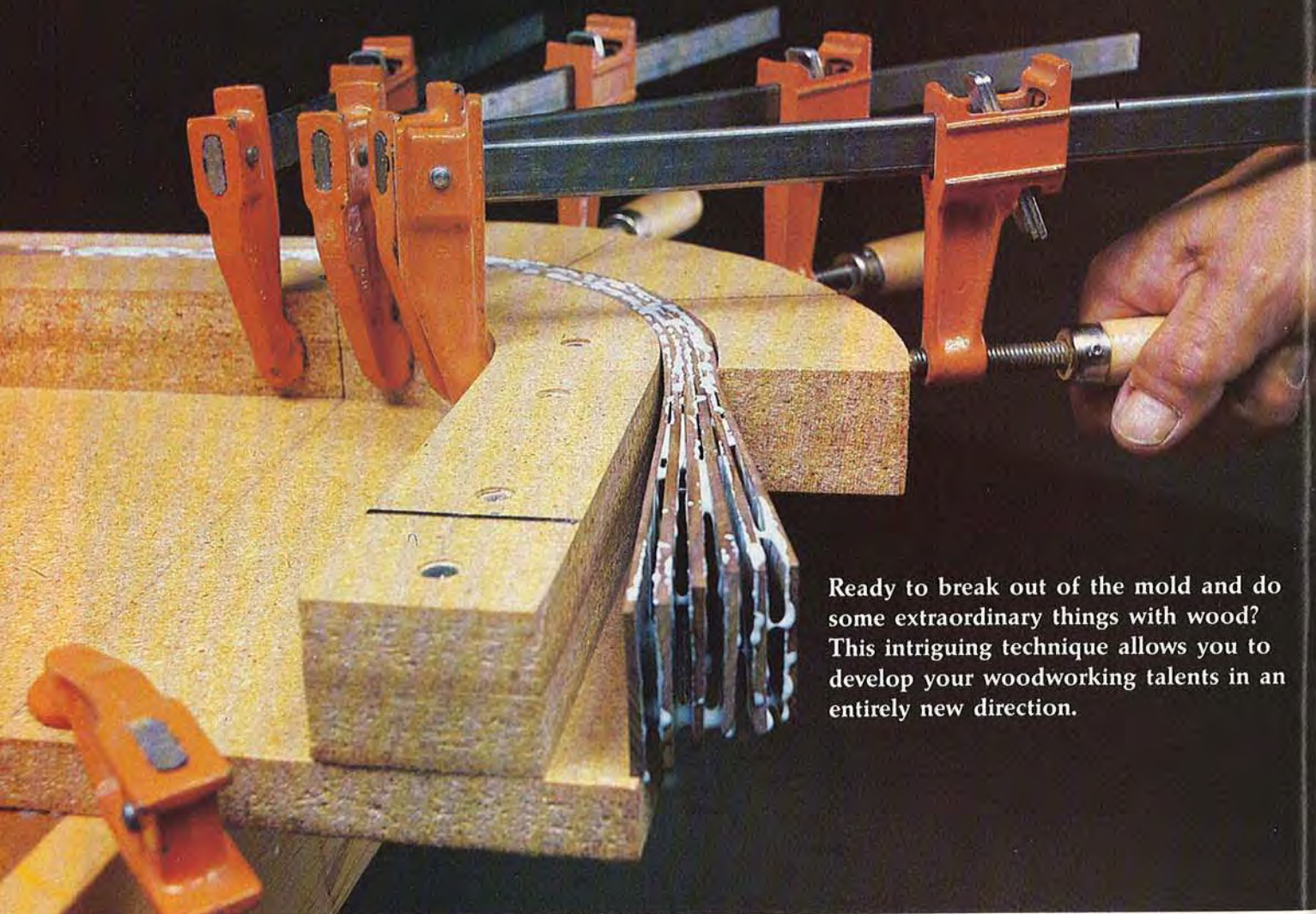

Ready to break out of the mold and do some extraordinary things with wood? This intriguing technique allows you to develop your woodworking talents in an entirely new direction.

TYPICAL USES OF BENTWOOD LAMINATIONS

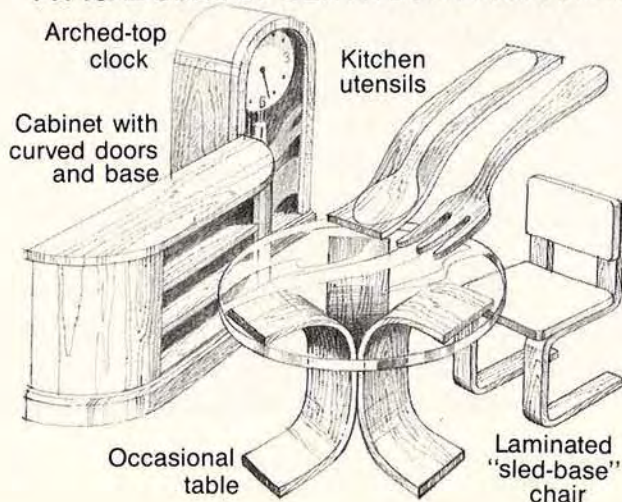

From the time most woodworkers put a saw to that first board, they're continually told of the importance of things being square, straight, and properly aligned. That's good advice, and remembering it will serve you well in the majority of your experiences as a woodworker.

But sometimes, in order to achieve the desired result, you need to be able to make wood conform to an irregular shape. The various projects illustrated at left are but a few of the many such situations you may encounter.

2 DIFFERENT APPROACHES TO BENDING SOLID WOOD

You can bend solid stock either by *steaming* the wood and then bending it around a form or by *laminating thin strips* together with glue and clamping the strips to a form. We prefer laminating for several reasons.

First, the results are much more predictable. All bent wood wants to spring back to its original configuration, but the glue holding laminated strips together, in large measure, prevents this from happening. With steam-bent wood, you can never predict the results.

Second, laminated bent wood has much greater strength than does its steam-bent counterpart. And third, thin-strip laminating allows you to produce near-duplicates of the first piece, an advantage that you can't achieve easily with steam-bending.

We think that after reading this article you'll agree that thin-strip laminating is definitely one technique you want to try. The technique itself is easy to employ, so it's not something you should shy away from for that reason. However, it does require some up-front knowledge about how to select the right board for bending, how to saw the strips that will be laminated, and how to make forms.

TIPS ON SELECTING THE RIGHT WOOD AND GLUE FOR BENDING

Every wood species has characteristics that make it unique. Some woods are more dense than others, some work with greater ease, and not surprisingly, some bend more successfully than other species.

We were curious to find out how well several species we had on hand would bend. Though the test could hardly be called scientific, we did make some findings we think are interesting. We ripped $\frac{1}{8}$ " thick strips $\frac{3}{4}$ " wide from 13 boards (each a different species) and bent them around curves with various radii.

In general, we found that the native hardwoods bent to the tightest radii, followed by the softwoods, and then the exotics. The overall champ was red oak (3" radius), followed closely by white oak and pecan (4"), cherry, maple, and beech (5"), birch, ash, walnut, and ponderosa pine (6"), sitka spruce (7"), Honduras mahogany (8"), and teak (12"). The exotics repeatedly broke without warning (without first splintering and cracking). The photo below shows some of the species before, during, and after being bent.

We also found that if we dry-clamped the strips around a form and let them stay that way for

several minutes before gluing and clamping, we could bend them more tightly than was otherwise possible. Some species also demonstrated much better *memory* (ability to hold their shape after dry-bending) than others.

Choose your boards carefully

How successful you are at bending laminated wood strips has a lot to do with how picky you are when selecting boards to use. Because bending places a lot of stress on wood, you want to choose boards that are free of defects such as knots and erratic (contorted) grain pattern. Oftentimes, you have a situation like that shown below where one part of a board may be totally

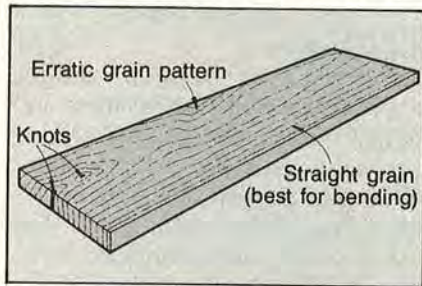

unacceptable for bending and the other part just right.

It's important to cut your strips from a board so that the straight grain follows the direction of the bend. The sketch below shows what we mean. In situation 1, you

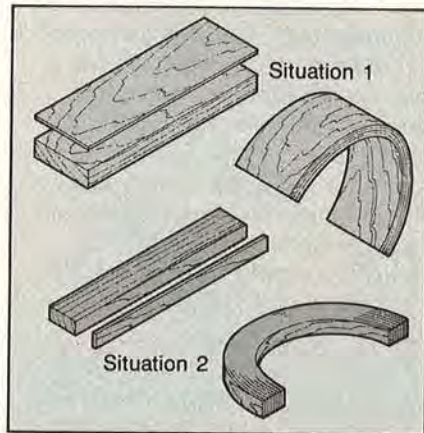

would want to slice strips from one of the faces of the board. But in situation 2, for the greatest strength you should rip material from one of the board's edges.

Just in case you're sitting there

Continued

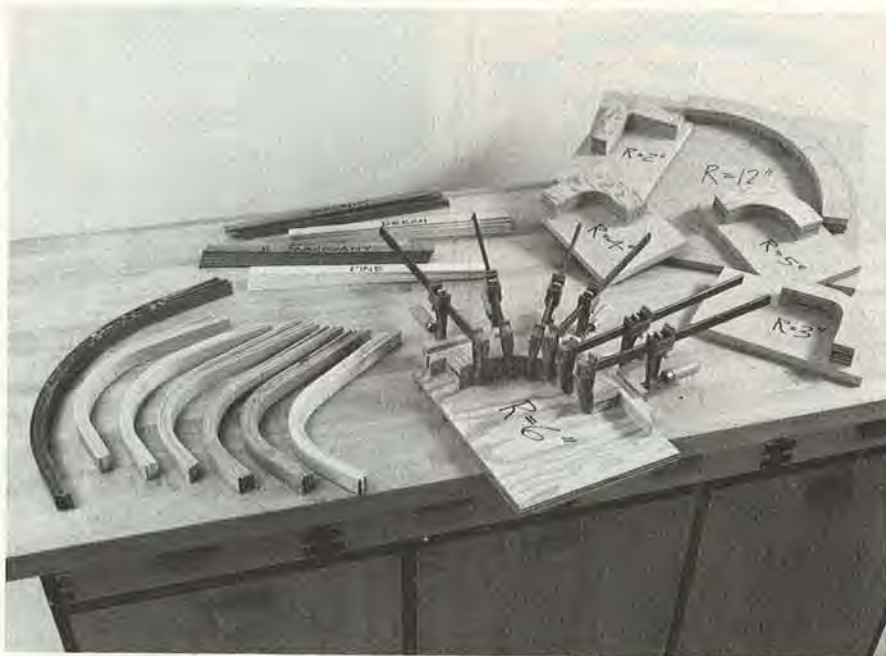

thinking we might be making too big a deal out of the importance of grain direction, we thought we'd show you the close-up below. It clearly demonstrates what usually



happens if the grain runs across the length of the bend rather than parallel to it.

The glue you use makes a difference

Just as you want the right board for a given bending situation, there are certain times when the type of glue you select can make or break your effort. We've used four different types since we've begun experimenting with laminated-wood bending. And here's what we've found.

If you're involved with a large-scale project that won't be exposed to moisture, use *polyvinyl acetate (white) glue*. It's strong enough to do the job, and its long open time allows you to complete the lamination before the glue sets. Conversely, to reduce glue-up time, go with *aliphatic resin (yellow) glue*.

And for projects that call for a waterproof adhesive, we've had good success with *resorcinol* and *epoxy* glues. These last two glues also have good gap-filling properties, an important characteristic on larger projects where it may be difficult to apply sufficient clamp pressure to close all joint lines.

Note: If your project involves exotic woods, which tend to be oily, make sure you choose resorcinol or epoxy. Neither white nor yellow glue will work well. And if you're laminating flexible ($\frac{1}{64}$ ") veneer, you must use epoxy to stabilize the lamination. With other glues, the veneer will remain flexible.

HOW TO PRODUCE WOOD STRIPS FOR LAMINATING

Rarely is it practical to bend wood strips that are greater than $\frac{1}{4}$ " thick. So you've either got to rip or resaw material you have on hand to the needed thickness or purchase what you need from a mail-order supplier. You lose control of grain direction with purchased stock, but we've worked successfully with it.

The project itself determines how thick the strips should be

As a general rule, the thicker the strips you use, the greater the control you have during the bending process. That's because you're dealing with fewer strips, and consequently fewer machining inaccuracies. But the reality of the situation is that to negotiate small-radius bends, the strips sometimes have to be $\frac{1}{16}$ " or even thinner.

To provide you with a yardstick by which you can determine the proper thickness of strips needed for a given project, we conducted another experiment. Using red oak as our representative sample, we bent $\frac{1}{4}$ " , $\frac{1}{8}$ " , $\frac{1}{16}$ " , veneer ($\frac{1}{28}$ "), and flexible veneer ($\frac{1}{64}$ ") to the tightest radius possible. The photo below shows the results we achieved.

HOW TIGHT CAN YOU BEND?
We just had to find out!

- R=12" $\frac{1}{4}$ " strips
- R=3" $\frac{1}{8}$ " strips
- R=2" $\frac{1}{16}$ " strips
- R=1" veneer ($\frac{1}{28}$ ")
- R=1/2" flexible veneer ($\frac{1}{64}$ ")

These and the earlier conclusions we made about the relative bendability of various species should help you make your decision.

3 ways to saw your own strips

Here again, the project you're making dictates which method makes the best sense to use. For narrow strips no less than $\frac{1}{4}$ " thick, you can rip the needed stock from the edge of a board.

However, if you need narrow strips less than $\frac{1}{4}$ " thick, use our thin-strip ripper as shown in the photo below. This device prevents strips from getting banged up by the saw blade after they have been cut.

Wider strips call for a different strategy. And that's where the resawing jig shown in use at the bottom of this column comes into

Note: We show how to build the thin-strip ripper in the August, 1985 issue of *WOOD*, page 64 and the resawing jig in October, 1985, page 45. If you don't have these issues, drop us a line and we'll send you a copy of the articles. Enclose a stamped, self addressed, business-sized envelope.

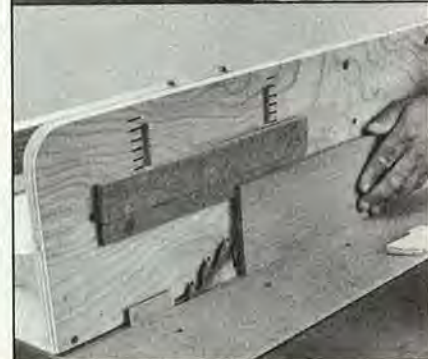
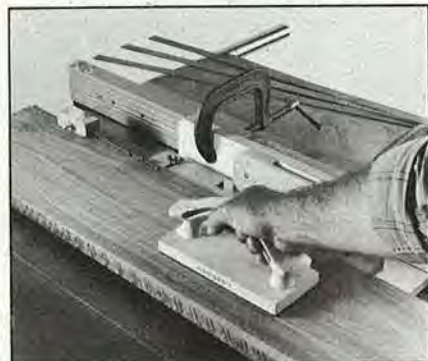

play. It's similar in function to the thin-strip ripper.

With projects that demand that you bend to extremely tight radii, you will have to go with veneer or the even thinner flexible veneer. You can cut flexible veneer to width with a straightedge and a sharp utility knife. But with standard veneer we've had good luck stacking several pieces atop one another, sandwiching them in the jig shown below, and running them through the table saw.



Pointers to remember when sawing thin strips

- Always cut the strips a few inches longer than you need because they have a tendency to shift lengthwise during clamping. This shifting can cause a shortage of material at one or both ends.

- Cut the strips about $\frac{1}{4}$ " wider than the finished width. Doing this allows you to compensate for any lateral movement of the strips during clamping.

- If it is important for the finished piece to look like solid stock, be sure you keep track of the order in which the strips come off the board. One of the best ways to do this is to number them. Laminating them together in their correct sequence will minimize the impact of the joint lines between each.

- Before cutting strips, make sure the saw and the jig (if you use one) are set up correctly to make uniformly thick strips. Otherwise, your lamination will twist and distort.

- Bend the strips soon after cutting them. The strips will become more brittle the longer you wait.

MAKING THE FORM—AN INTEGRAL PART OF THE PROCESS

To make your thin strips conform to the desired shape, you need to build a form. In broad terms, there are only two types to choose from—one-piece forms and two-piece forms. We show both types

(including several variations of the one-piece type) below. For most situations, except those requiring extremely even pressure along the length of the mold, one of the one-piece forms will do the job. Here again, the project determines the form's shape, size, and configuration.

SEVERAL FORM OPTIONS AT A GLANCE

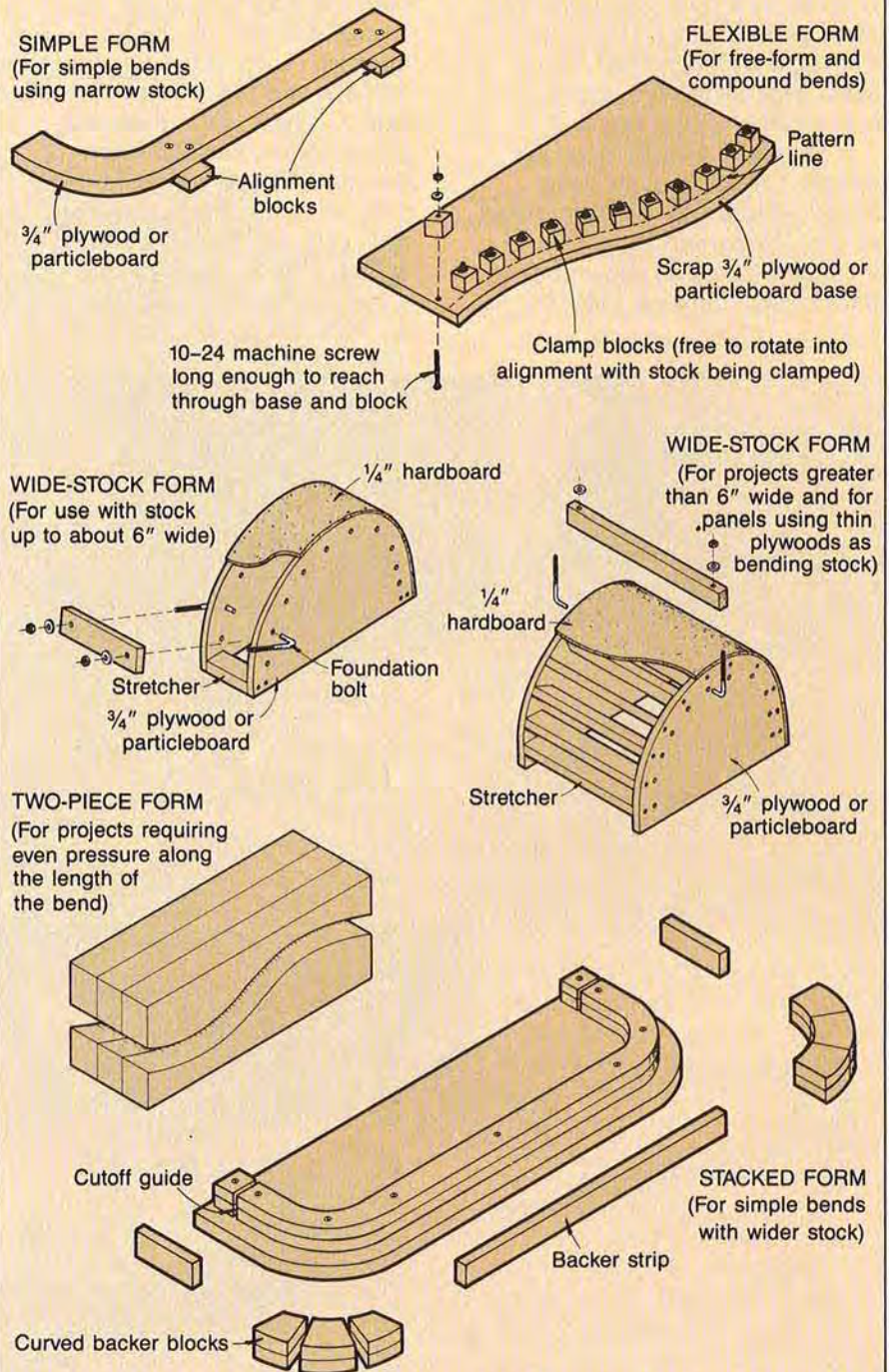

Continued

How to transfer a pattern onto the form

Unless you design your own projects, you'll be working from a furnished plan or a set of drawings. And unless you've been provided with a full-size pattern, you've got to enlarge and then transfer the shape to the form material. Often, you'll be given a grid pattern or a plotted point pattern.

In both of these cases, purchase or make your own graph paper to the scale called for. Then, transfer the points of intersection to the graph paper, and draw in the lines between the various points.

If you don't plan to re-use the pattern, just apply some spray-mount adhesive to the form material, glue the pattern to it, and cut the desired shape as shown below. But if you're thinking you may

want to make several of the same item, get yourself some dressmaker's carbon and transfer the shape onto the form that way.

How to create a smooth curve

Some projects call for parts that curve gently over their entire length. In these instances, you can use the technique shown at the bottom of this page to obtain the result you want. First, plot the points at which the stock will change direction on the form material. Then, drive a series of finish nails into the form so that the strip will intersect at these same points. Now, thread a length of thin stock (on edge) around the nails, adjusting the intermediate nails until you have the curve desired. Then, mark the line of the curve on the form material.

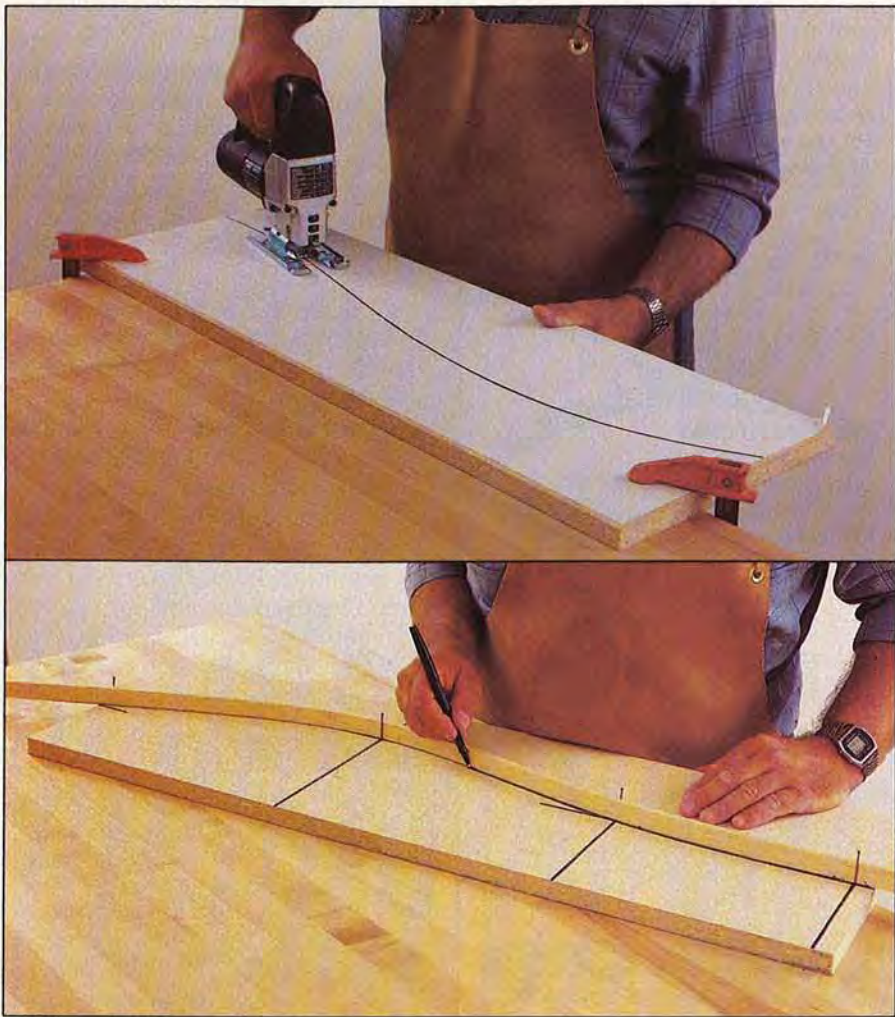

A nifty jig for clamping small-radius corners

It's never easy to bend laminated wood around a tight corner. Why? Primarily because small radii don't allow you sufficient room to place your clamps closely enough together to ensure adequate pressure along the entire length of the curve. Embarrassing gaps between the laminations usually result.

But the idea behind the jig shown below eliminates most all the problems you would otherwise experience. Basically, it's a press that forces the wood around the corner and holds it in position until the clamps and clamping strips beyond the turn capture the wood. You can adapt this principle to many bending situations.

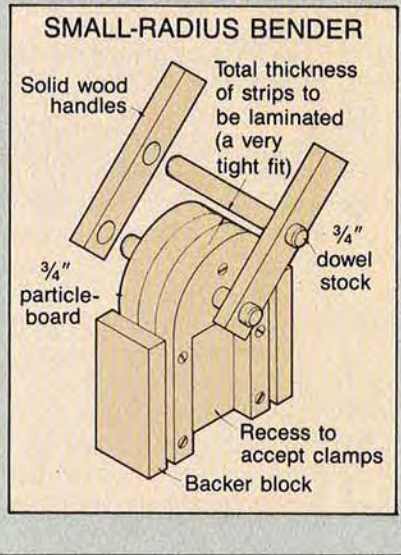

GET READY . . . GET SET . . . GLUE

Because time is of the essence after the glue has been brushed on the wood strips, you've got to have everything on hand and well organized before you begin. Photo 1 below shows you what we're talking about. You'll want to have plenty of clamps at the ready, the work surfaces protected, and the form protected from the glue (you can use waxed paper for this or coat the form with paste wax).

Gluing and clamping the lamination

We like to lay out the wood strips in the order in which we cut them, as shown in the photo 2. Then, we apply a liberal coat of glue to both sides of each strip (except the top and bottom strips) and stack them.

Next, we arrange the strips along the form and begin clamping—see photo 3. (Note that the centerpoint of both the form and the strips have been marked.) To minimize

any twisting of the strips as they go around a curve, we clamp an alignment block at both ends of the straight section of the form. Then we begin clamping at the center and work our way toward the curved sections: (You can figure on having to place a clamp about every 3–4" along the lamination's length.) Notice the clamping strip we used for even pressure.

We've found that when clamping around curves, we're a lot better off when we finesse the strips rather than try to bully them into submission. Say, for example, if we use three clamps to turn the corner, we get all of them started and then tighten them gradually and evenly. Notice in photo 4 that we also use curved clamping blocks. These allow us to maintain constant pressure over the entire area being glued. You may need the alignment blocks when negotiating curves.

Once the clamps have been tightened and the strips are fully together, we remove as much of the glue squeeze-out as possible (see photo 5). Doing this messy job before the glue sets up makes finishing the edges of the lamination much easier. We usually use a putty knife and an old rag to remove the glue.

Truing up and trimming the lamination

After letting the glue dry overnight, we loosen the clamps and take the lamination out of the form and inspect it. If the piece is suitable for use, we then return it to the form and clamp it so the top of the lamination is slightly above the form. This allows us to use the form to steady the lamination as its edges are being trued. We've had good luck using a belt sander, plane, and a cabinet scraper (see photo 6).

With the lamination still clamped to the form, we trim the ends of the lamination, using the cutoff guide to guarantee a correct cut—see photo 7. And when that's done, we remove the clamps and sand the lamination smooth. ■

Photographs: Bob Calmer
Illustrations: William Zaun

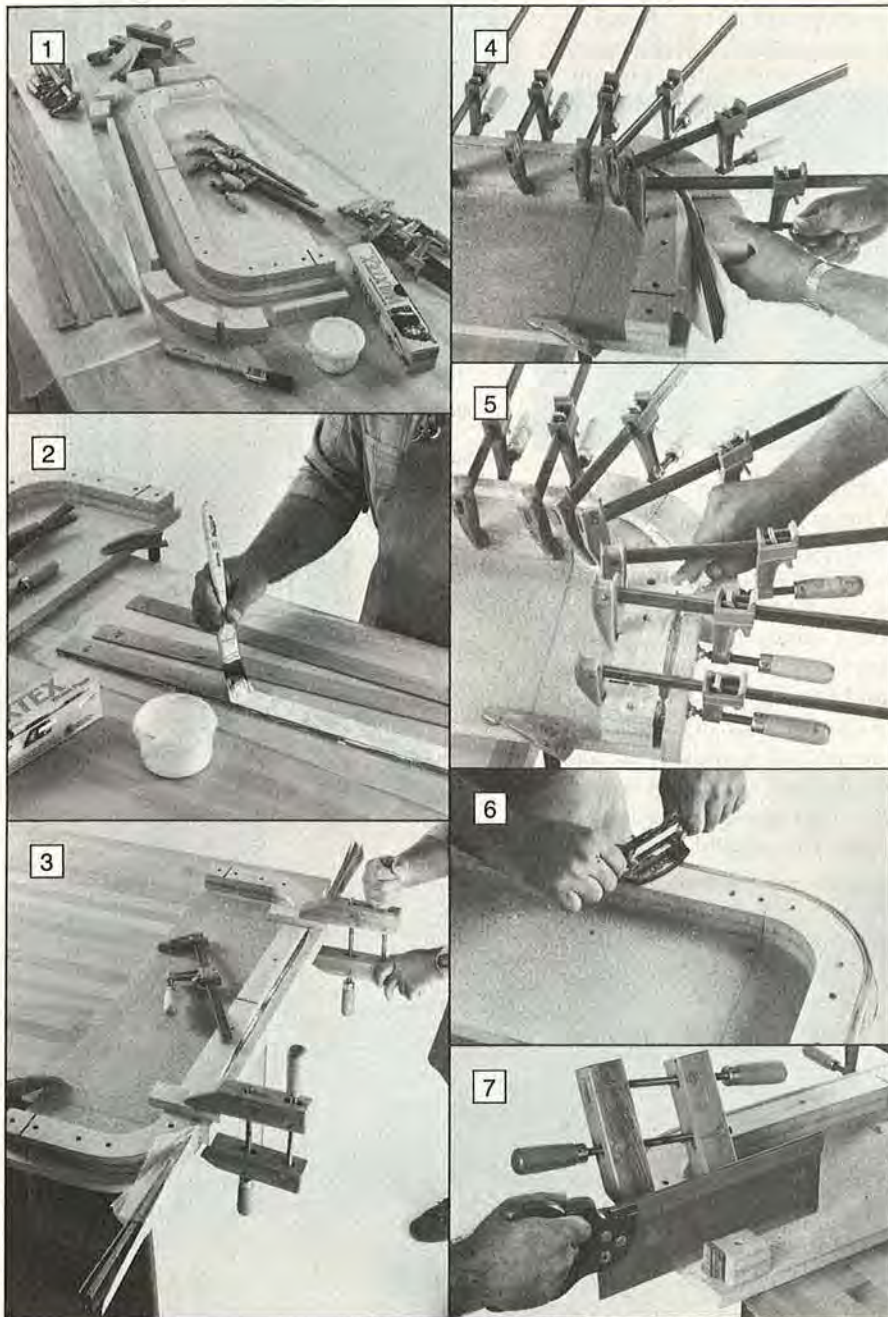

Hang it all!

OAK COAT-TREE

Now that you're wise to the tricks of the bentwood lamination trade (thanks to the preceding article), head for the shop and apply what you've learned. You won't find a better test project than this sturdy coat-tree, with its curved uprights of resawn oak strips. Be sure to save the bending form when you're finished—you can bet that someone will be asking you to make a duplicate coat-tree for *their* house.

BUILDING THE FORM

1 Cut the pieces for the form to size and shape as dimensioned in Bending-Form Drawing. Glue and stack the particleboard strips to form the sections used to shape the upright (A, B, C, and D). Sand the surface of the particleboard that will come in contact with the oak strips smooth and screw the sections to the particleboard base.

2 Using a fine-toothed handsaw, cut through the particleboard strips to form the cut-off guides shown in the drawing. (The guides will be used later for trimming the ends of the laminations.) Chamfer both ends of the base so they run parallel to the strips.

LAMINATING THE UPRIGHTS

1 Rip ten 2 1/8"-wide strips from 3/4"-thick oak stock that's at least 7' long. Crosscut the 2 1/8" strips to 78".

2 Resaw the strips (the stock will be on edge) to 1/8" thick. (You'll end up with more than the required 24 thin strips—six for each upright—but you'll

probably break a few when resawing and bending.) Then mark the lengthwise center of each strip.

3 Lay waxed paper on the form, then glue and clamp six thin strips to the form to laminate the longest upright (A) as shown in the photo, below. Make sure



the center marks on the form and the strips line up. (We poured the glue into a paint tray and applied it to the strips with a narrow paint roller. We also found it handy to have a helper on hand when bending the wood around the curves.)

4 After the glue dries, remove the laminated upright from the form, and get rid of the waxed paper clinging to the upright. Reclamp the upright to the form,

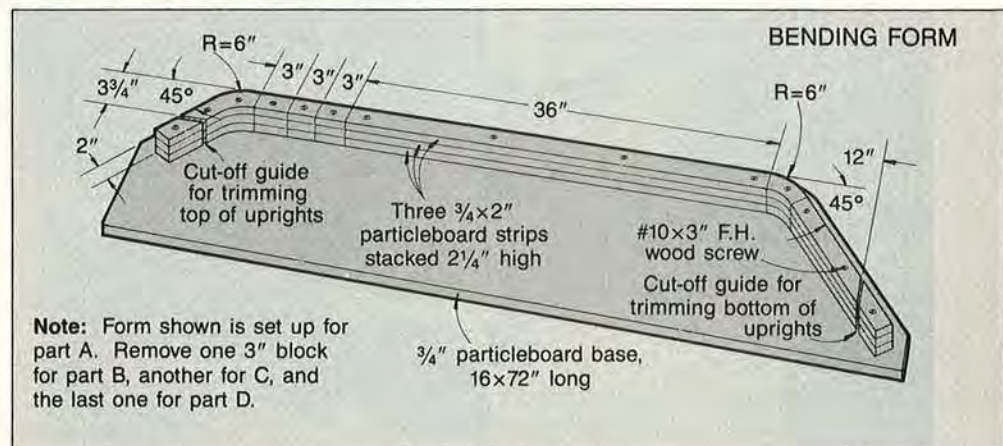
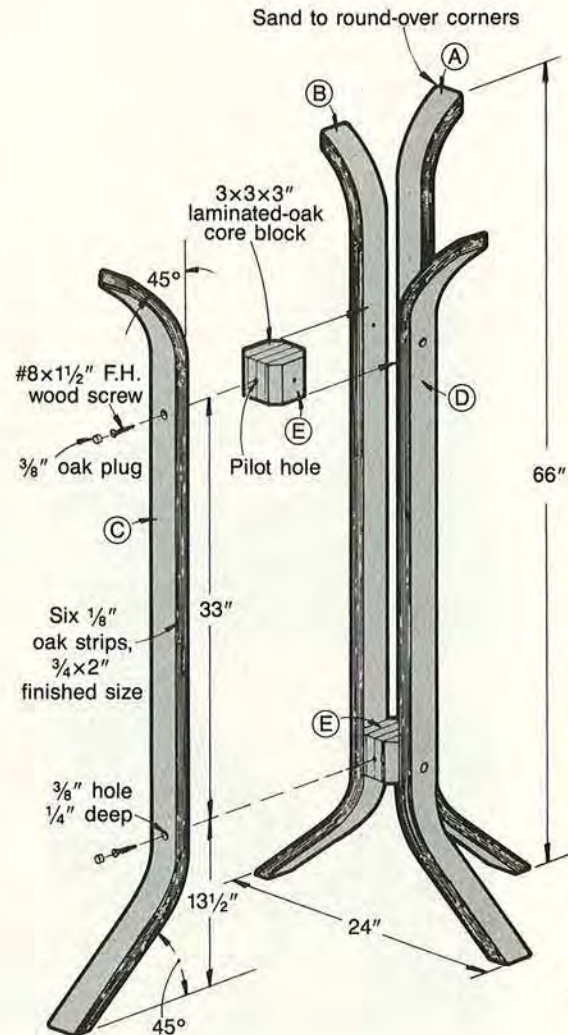

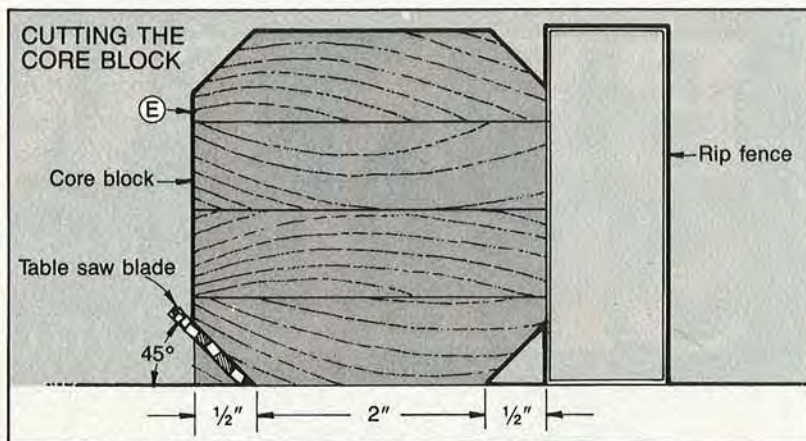

making sure the top edge of the upright is slightly above the top edge of the form. Use only enough clamps to hold the lamination in place. Scrape the excess glue from the top edge of the lamination, and use a hand plane or a belt sander to smooth the edge. Check the edge periodically with a small combination square to ensure squareness; sand the edge smooth. Flip the lamination over and repeat this process with the other edge, planing the upright down to a 2" finished width.

5 Using a fine-toothed handsaw, trim both ends of the upright using the cut-off guides shown in the Bending-Form Drawing.

6 Remove one of the 3" sections from the form. Then reposition the curved portion of the form so it fits snugly against the center section, and rescrew it to the base. (Save the 3" piece if you plan to reuse the form later.) Now repeat the procedure for upright A to make the second-longest upright (B).

7 Laminate the remaining two uprights (C, D), following the same procedure.

Don't forget to remove another 3" section each time.

8 Sand the ends of each upright to round over the sharp edges as shown in the Exploded-View Drawing.

Then, using sandpaper,

break the edges and finish-sand all four uprights.

FORMING THE CORE BLOCKS

1 Cut four pieces of $\frac{3}{4}$ " oak $\frac{3}{4}$ " wide by 10" long. Glue and clamp the pieces together. After the glue dries, scrape off the excess and plane, joint, or rip the lamination to $3 \times 3 \times 10$ ".

2 Using the drawing, *above*, as a guide, cut the chamfers at each corner of the lamination with a table saw. Crosscut the lamination into two 3'-long blocks (E). Sand both blocks.

ASSEMBLING THE COAT-TREE

1 Glue and clamp two opposing uprights (A, C) to the core blocks, keeping the bottom of the uprights level. Drill $\frac{5}{8}$ " holes $\frac{1}{4}$ " deep into the uprights where shown in the Exploded-View Drawing. Then drill a pilot hole through the center of each hole for the #8 $\times 1\frac{1}{2}$ " wood screws. Fasten all four uprights to the core blocks in this manner.

2 Cut $\frac{3}{8}$ " oak plugs, glue them into the holes over the screws, and sand the plugs flush. Apply the finish. (We used a small foam brush to apply polyurethane. These come in handy when coating the inside of the uprights.) ■

Project Design: James Downing
Photographs: Hopkins Associates
Illustrations: Bill Zaun, Randall Foshee

NOW YOU CAN BUILD IT

BENTWOOD SLED

Just like
Granddad's!



We think you'll agree that just about anything becomes more special when it's made of wood. Case in point: This walnut and ash adaptation of an old-time sled. Why settle for one of those throwaway plastic jobs when you can build an heirloom that will delight youngsters for generations? The epoxy-laminated runners and supports make this sled amazingly strong and moisture-resistant, yet lightweight enough to whoosh down a hill with the best of 'em. Just ask Granddad...

Note: If this is your first attempt at either laminating or using epoxy, refer to the article "How to bend laminated wood" on page 36 and our "Epoxy" article on page 60 of this issue.

FORMING THE RIBS AND RUNNERS

1 Construct the bending forms for the runners (A) and ribs (B) from $\frac{3}{4}$ " particleboard, as dimensioned in the Bending-Form Drawing. (We used a belt sander to smooth and square up the curved pieces before attaching them to the base of the form.)

2 From straight-grained $\frac{3}{4}$ " ash, rip 12 strips $\frac{1}{8}$ " thick by 60" long for A, and 18 strips $\frac{1}{8}$ " thick by 36" long for B, as shown in the Cutting Diagram. Pieces are cut long and trimmed to length later.

3 Cover the edges of the forms with waxed paper to prevent the strips from sticking. Then, epoxy six of the 60" strips together and align them on the runner-bending form. Clamp the strips to the straight end of the form first, then work toward the curved end, tightening the clamps uniformly as you go. Allow the epoxy to set up at least 12 hours. Remove the clamps and sand the runner edges smooth. Repeat this procedure to make the other runner.

4 Use a router with a $\frac{1}{4}$ " round-over bit to shape the bottom edges of the runners. (When routing any lamination, move the router very slowly to avoid chip-out.) With a backsaw, cut the tail ends to length, using the cut-off guide on the bending form.

5 To make the first of the three ribs (B), repeat the preceding techniques, but begin clamping toward the center of the form and work around to each end.

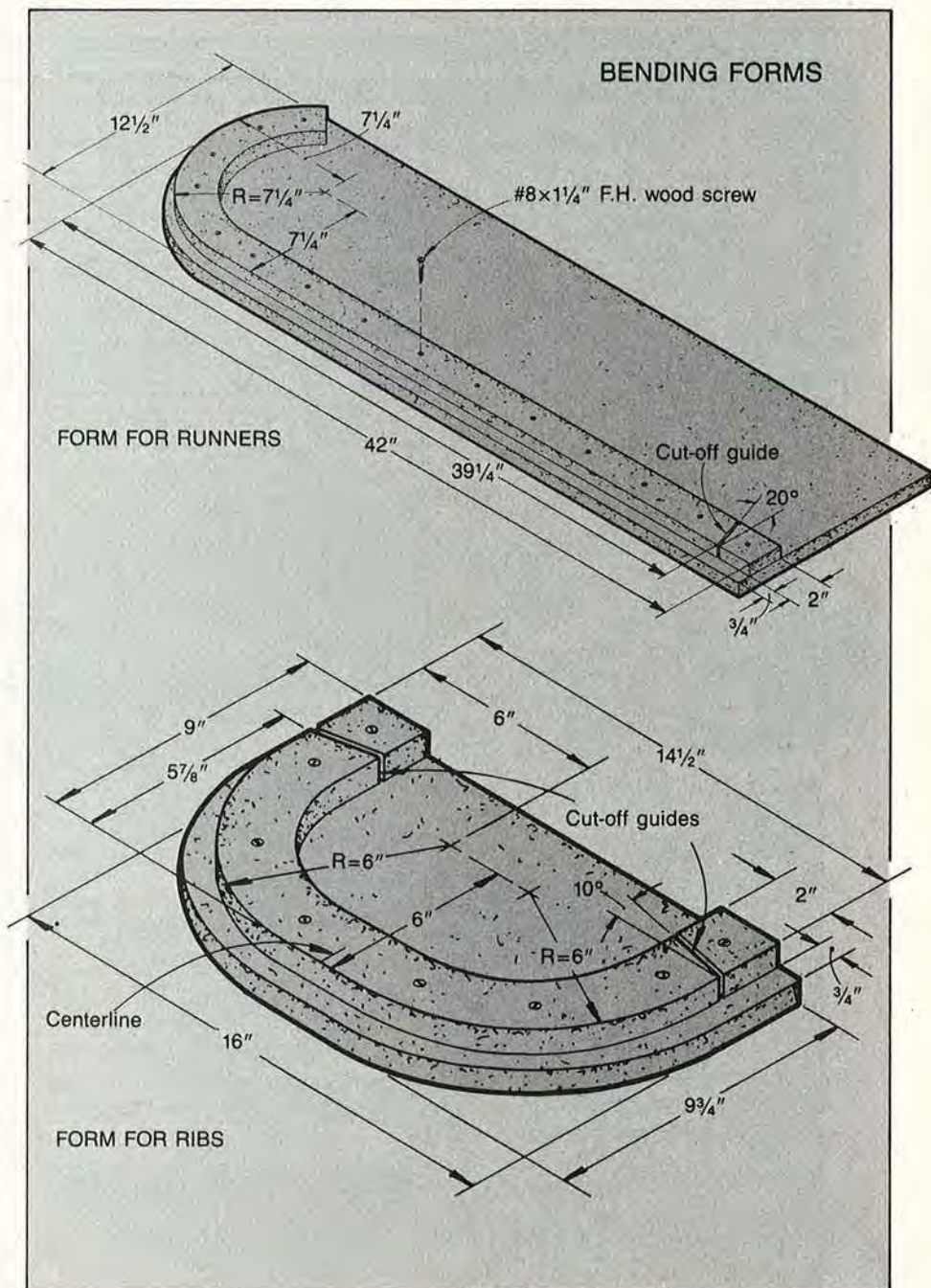

Continued

NOW YOU CAN BUILD IT/BENTWOOD SLED

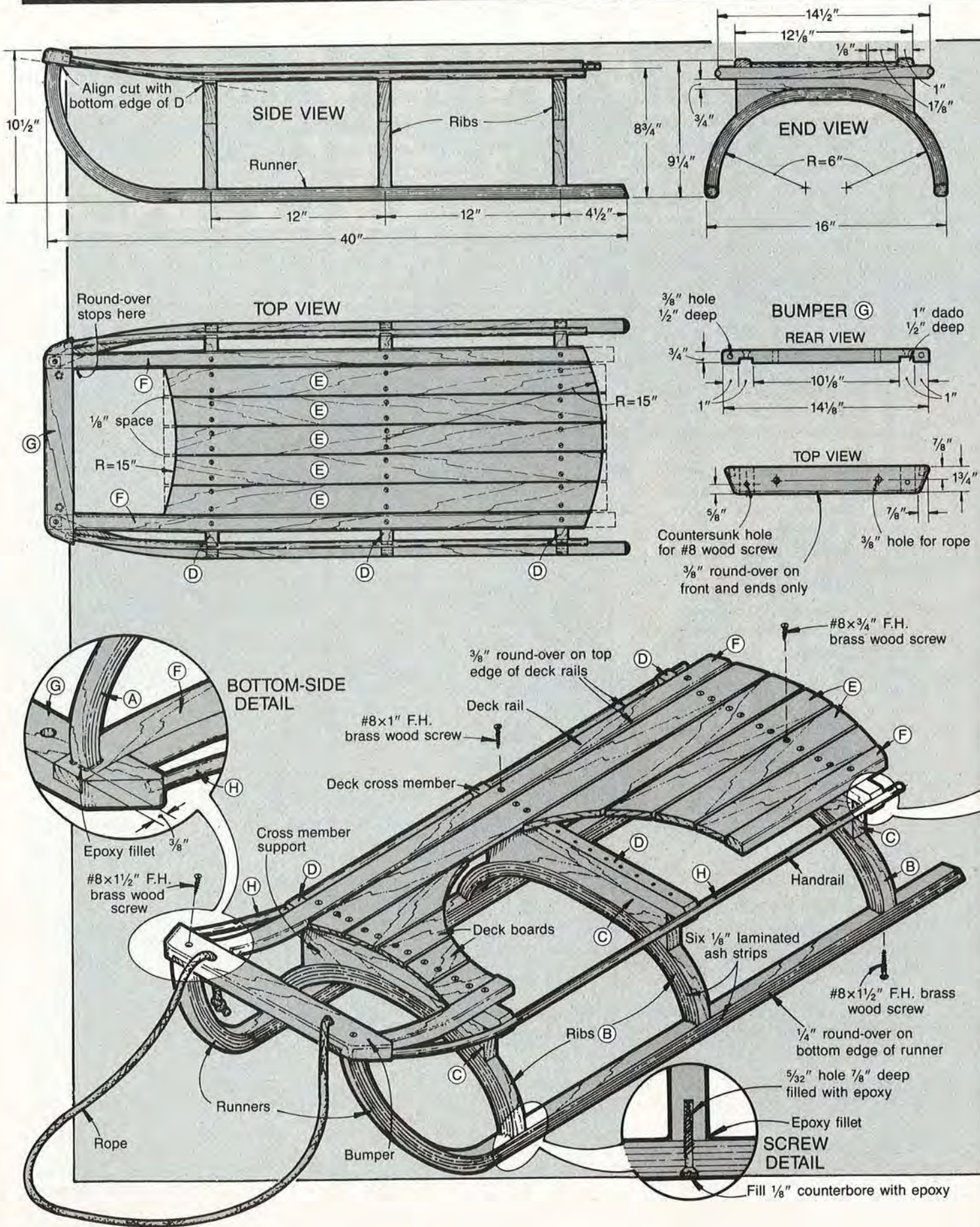

MARKING THE SUPPORT

Mark the top edge of the rib onto C

Line up centerlines

C

2 3/4"

Rib B

4 3/4"

10°

Chamfer

HANDRAIL
DETAIL

Bill of Materials

Part	Finished Size*			Material	Qty.
	T	W	L		
A*	3/4"	3/4"	46 5/8"	ash	2
B*	3/4"	3/4"	22"	ash	3
C	3/4"	2 3/4"	12 1/8"	walnut	3
D*	3/4"	3/4"	14 1/2"	ash	3
E*	1/4"	1 7/8"	29"	ash	5
F*	1/2"	1"	36 3/4"	walnut	2
G	3/4"	1 3/4"	14 1/8"	walnut	1
H	3/8" diam.		36"	oak dowel	2

*Some parts are cut larger initially, then trimmed to finished size. Please read the instructions before cutting.

Supplies: #8 x 3/4" flathead brass wood screws, #8 x 1" flathead brass wood screws, #8 x 1 1/4" flathead brass wood screws, #8 x 1 1/2" flathead brass wood screws, epoxy, coloidal silica, 6' of 1/4" braided nylon rope, exterior polyurethane

Cutting Diagram

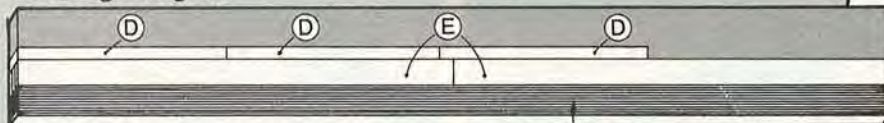

3/4 x 7 1/4 x 60" Ash

A twelve 1/8" strips



3/4 x 7 1/4 x 36" Ash

B eighteen 1/8" strips

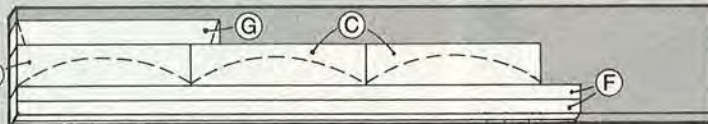

3/4 x 7 1/4 x 48" Walnut

6 Sand the edges of the rib smooth, remount it on the rib-bending form, and mark the centerline. Using the cut-off guides shown in the Bending-Form Drawing, trim both ends of the ribs. Repeat this process to make the other two ribs.

7 Rip the three 3/4" walnut support members (C) to 2 3/4" and crosscut them to 12 1/8". Mark the lengthwise center of each. From 3/4" particle-board scrap, cut a piece 4 3/4" wide by 18" long. Stand it on edge next to one of the ribs and position C on the top edge of the particle-board so that the centerlines of B and C align. Mark the top edge of B onto C as shown in the drawing, left. Use a band saw or jigsaw to cut the bottom edge of C to shape, then sand it to fit smoothly onto the rib. Repeat this to fashion the other two supports.

8 Cut a piece of 3/4" thick ash 3/4" wide by 48" long, then crosscut it into three segments 15 1/2" long for the deck cross members (D). With a 3/8" bit, drill a hole on center of the edge, 1/2" in from each end of each D. Bevel-cut the ends at 45°, bisecting the holes just drilled to obtain a cove as depicted in the Handrail Detail.

9 Mark the lengthwise center of each deck cross member. Epoxy and clamp together one of the B's, C's, and D's, using the marked centerlines to align all three parts of the rib assembly. After the epoxy dries, remove the clamps and sand the assembly smooth. Repeat this for the other two rib assemblies.

ASSEMBLING THE DECK

1 From 3/4" ash, cut three pieces 1 7/8" wide by 30" long. Set up your table-saw rip fence to resaw the boards to a thickness of 5/16" to yield the deck boards (E). (Use a feather board and push stick for safety.)

2 Lay the deck boards flat on a work surface with one end of each butted up against another thin

Continued

board to hold the pieces in position when machining. Then belt-sand or plane both sides smooth and to a uniform thickness of $\frac{1}{4}$ ".

3 Lay $\frac{1}{8}$ "-wide hardboard spacers between the deck boards for even spacing. Then securely tape the deck boards and spacers together and mark a 15" radius on each end of the deck boards as shown in the drawing at *right*. Mark the centerline of each rib assembly across the top of the deck boards for later mounting to the rib assemblies. With the deck boards still taped together, cut the marked curves and sand the edges smooth.

4 Position and clamp the taped deck board assembly on the three rib assemblies as dimensioned in the Top-View Drawing, checking that the deck boards are square with each rib assembly. Then drill and countersink two pilot holes through each deck board and into the cross members on the marked centerlines. (We used a countersink screw bit for a #8 wood screw to drill the pilot holes.) Apply epoxy to the joints and screw threads, then attach the deck boards and remove the tape and spacers.

ATTACHING THE RUNNERS

1 To locate the runners on the sled assembly, mark the rib centerlines on the runners where indicated in the Side-View Drawing. Counterbore a pilot hole, centered on each mark, through the bottom of the runner as shown in the Screw Detail. Clamp the runners in place on the bottom of the ribs as pictured in photo A, *right*. Using the pilot holes in the runners as guides, drill $\frac{1}{32}$ " pilot holes into the ends of the ribs. Epoxy the joints and screws into place, leaving a fillet of epoxy at each joint (also shown in the Screw Detail). (We added silica when mixing the epoxy to thicken the epoxy and prevent it from running. Silica also gives the epoxy greater strength and gap-filling capability. Mix the epoxy and silica together to the consistency of peanut butter before applying.

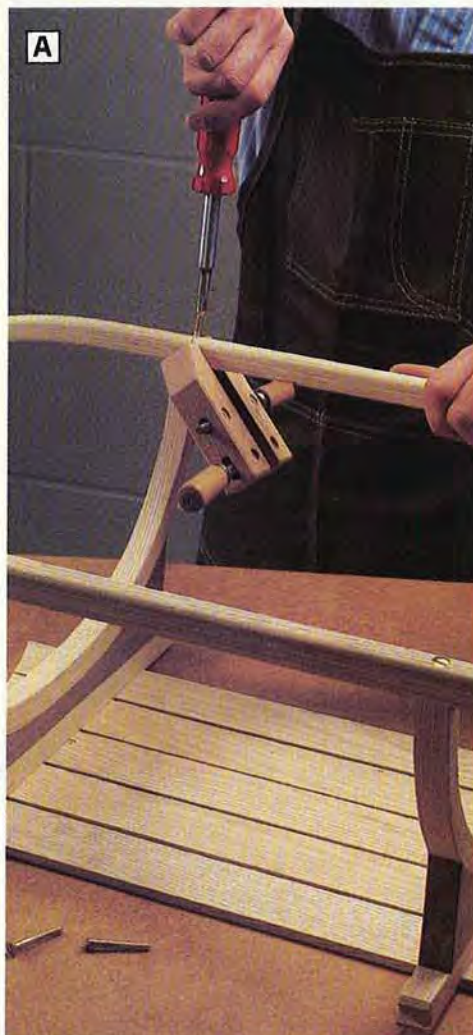
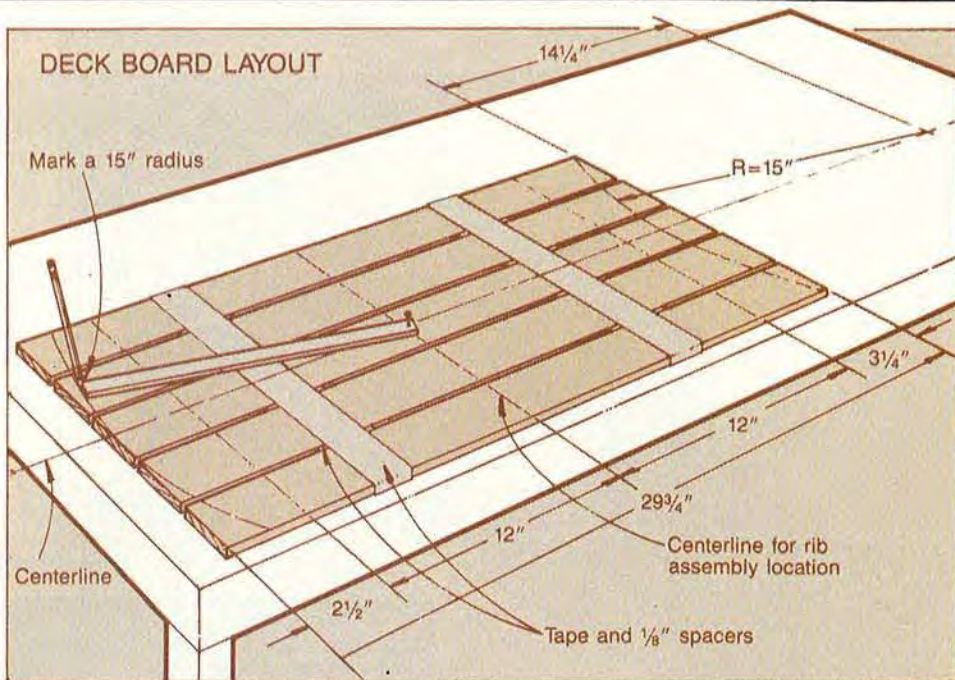

See Information Sources at the end of the "Epoxy" article on page 60 for the addresses of manufacturers of epoxy and silica.)

2 Clamp the forward ends of the runners to a 16" wide by 9 $\frac{1}{4}$ " high scrap board as shown in photo B, *below left*. Using the top of the scrap board as a guide, cut the runner, aligning the saw blade with the bottom edge of the foremost deck cross member (D) as shown in the Side-View Drawing. [The cut doesn't have to be absolutely perfect. The epoxy-silica mixture will fill the joint when you attach and epoxy the front bumper (G) to the runners later.]

FINAL CONSTRUCTION

1 Cut two pieces of $\frac{3}{4}$ " walnut 1" wide by 40" long for the deck rails (F). Plane or resaw the rails to $\frac{1}{2}$ ". (To form the rails, we started with $\frac{3}{4}$ " stock and planed it down to $\frac{1}{2}$ " thickness on our jointer. We used two push blocks to move the narrow stock safely over the spinning jointer blades.) Then, using a router with a $\frac{3}{8}$ " round-over bit, shape the top edges of each rail, stopping 2 $\frac{1}{4}$ " from the front ends.

2 Cut the front bumper (G) to shape as indicated in the Bumper Drawing. Using a router and a $\frac{3}{8}$ " round-over bit, rout the top-front edge and ends of the bumper. Now cut 1" dados $\frac{1}{2}$ " deep to accept the deck rails (F), and drill the holes for the handrails (H) and tow rope, as shown in the Bumper Drawing. Epoxy the front bumper to the deck rails, checking for square.

3 Lay the deck rail-bumper assembly (F-G) on the sled frame. Using clamps as shown in the drawing, *above right*, pull the runners back so that the bumper overhangs the front of the runners by $\frac{3}{8}$ " (also shown in the Bottom-Side Detail). Now, mark the location of the cross members (D) on the rails (F). Drill and countersink pilot holes through the rails and into the cross members. Epoxy and screw the deck rails into place.

PULLING THE RUNNERS BACK INTO POSITION

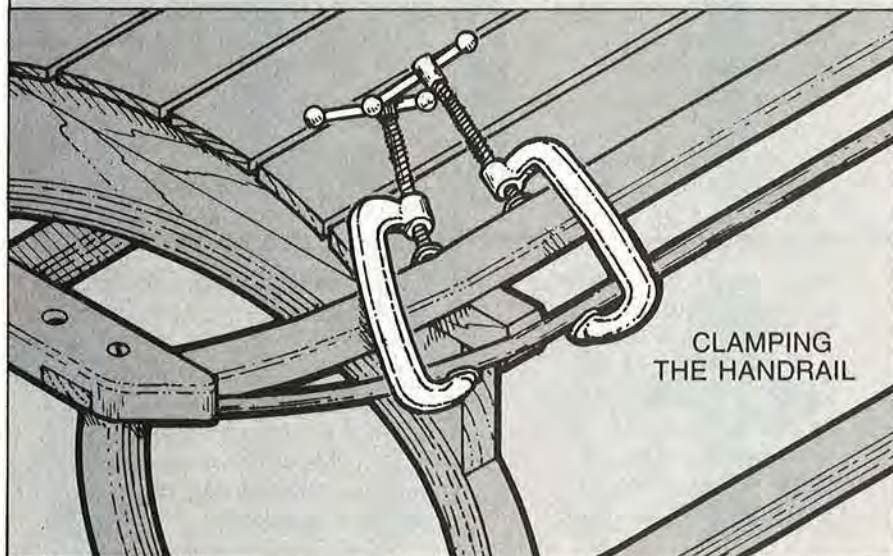
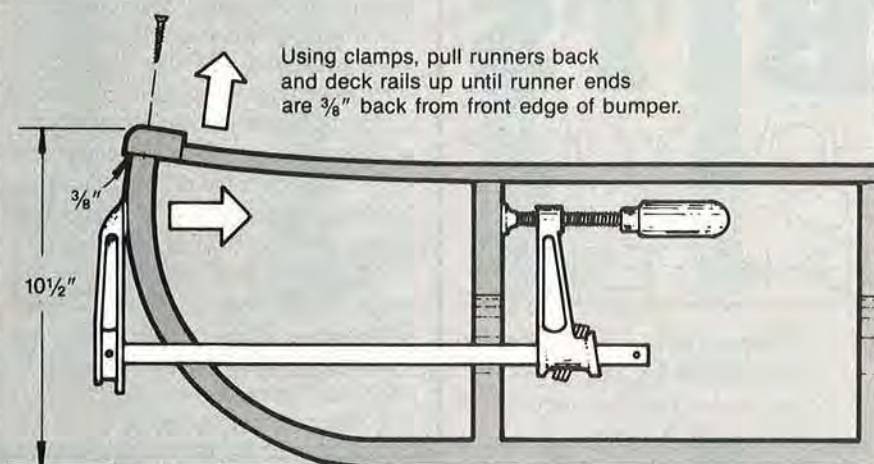

4 Drill and countersink pilot holes through the bumper-rail assembly and a $\frac{5}{16}$ " pilot hole into the ends of the runners. Epoxy the joints and screws into place, again leaving a fillet of epoxy around the joint.

5 Trim the tail end of the rails to match the 15" radius on the tail end of the deck boards.

6 Epoxy the handrails (H) into the $\frac{3}{8}$ " holes in the front bumper (G), then clamp and epoxy them into the coved ends of the cross members (D) as shown in the Handrail Detail. (We used two small clamps, one on each side of each cross

member, to pull the handrails into alignment as shown in Clamping the Handrail Drawing, *above*. The handrails have a tendency to spring out of alignment unless clamped this way.)

FINISHING THE SLED

1 Finish-sand the entire sled and apply several coats of exterior polyurethane. Attach the rope. Periodic applications of paste wax will further protect the sled from moisture and keep the runners slick. ■

Produced by: Marlen Kemmet
Project Design: Kim Downing
Photographs: Hopkins Associates, Bob Calmer
Illustrations: Bill Zaun, Randall Fosbee

ROUTER BITS

HOW YOUR CHOICES SHAPE UP

It happens before you know it—bit by bit, your router bit inventory builds until it's worth more than your router! A good, basic understanding of router bits and what they do can help you save some of that hard-earned cash and still get the most mileage from your router.

With several hundred options, including prices from \$5 to \$50, facing you when you want to buy a router bit, it helps to narrow your choices. To do that, you have to know the types of bits and what they're intended to do. Starting with what bits are made of, we've organized the selection on these pages.

Written with Roger W. Cliffe,
Associate Professor, Industrial Technology,
Northern Illinois University
Illustrations: Greg Roberts

WHAT ROUTER BITS ARE MADE OF

Stamped steel yields the least expensive router bits. Stamped into bit shape, rolled to configuration, then hardened, the flat steel used isn't meant for long-term routing or a depth of cut greater than $\frac{1}{8}$ " (it may bend). At about half the cost of a high-speed steel bit, it isn't practical to sharpen a stamped bit unless you do it yourself.

Climbing the price ladder to the under \$10 range, you'll find *high speed steel* (HSS) on the next rung. HSS bits, machined from solid-bar stock and ground to exact size, take the sharpest cutting edge of all bits.

However, they dull quickly in very hard wood and composition materials. Dennis Huntsman of Porter-Cable suggests honing the flat side of a HSS bit with a sharpening stone for extra mileage.

Add an edge of tungsten carbide to HSS, double the price, and you have the even more expensive *carbide-tipped* router bit. Carbide-tipped bits stay sharper about 20 times longer than HSS or stamped steel. And they'll easily shear most woodworking materials except metal, which can cause them to fracture. A tiny fracture, advises

STRAIGHT-CUTTING OPTIONS

Straight bits cut a rectangular groove in the workpiece, plane an edge, or make a rabbet. In most applications they require a fence or other control device to guide their cut.

These bits have either one or two flutes, which provide wood-chip clearance. *Single-flute* bits, although actually making only half

the number of cuts per revolution that *double-flute* bits do, cut faster because they have plenty of chip clearance.

Stagger-tooth straight bits, a two-flute type, have one cutter extending down from the top to slightly past center and the other coming up from the bottom the same distance. A stagger-tooth bit cuts as

EDGE-FORMING CHOICES

Edge-forming bits cut on the edge of the work with the help of a pilot that controls their straight or irregular path. The pilot may be either integral or removable ball bearing. Bits in this category include rabbeting, cove, roundover, beading, camfer, and classical.

Solid-pilot or single-piece tips usually measure a $\frac{1}{4}$ " or less in diameter, and because they rub on

the edge of the work at the same r.p.m. as the router, they can heat up and burn the wood. *Ball-bearing* pilot tips, on the other hand, roll along the edge at a slower rate than the revolution of the bit. Because they turn only at feed rate, ball-bearing pilot tips won't burn your work unless the bearing jams due to accumulation of dirt or debris. Porter-Cable's Huntsman

GROOVE-CUTTING SELECTIONS

Requiring a guide or fence to direct their path, groove-forming bits are designed to cut a channel in the face of a workpiece, such as in sign-making. They are very similar to edge-cutting bits except in that they have no pilot tip. In fact, groove-cutting bits may be used with a fence to rout an edge. Among the many choices in this group you'll find these often-used bits: round-nose (core box), ogee, classical, beading, dovetail, and veining.

SPECIAL PURPOSE ALTERNATES

Special purpose bits actually fall into one or the other of the functional categories, but they deserve special notice because they fill highly specialized needs. Among the bits in this group are piloted and ball bearing groove-forming cutters called slotting bits, edge-forming bits such as the flush trimmer for plastic laminates, and molding-type bits such as the raised panel cutter. Many of these make repetitious production work easier.

the Robert Bosch Company's Don Duffy, makes investing in a new bit more sensible than resharpening. He notes that industrial-quality, carbide-tipped bits may be resharpened up to six times if they show no sign of chips or fracture. But remember that each time a bit has to be resharpened, its diameter will be reduced slightly.

Manufactured in short lengths (under 1"), *solid-carbide* bits are used primarily for trimming laminates. The short length helps prevent bit deflection and fracture.

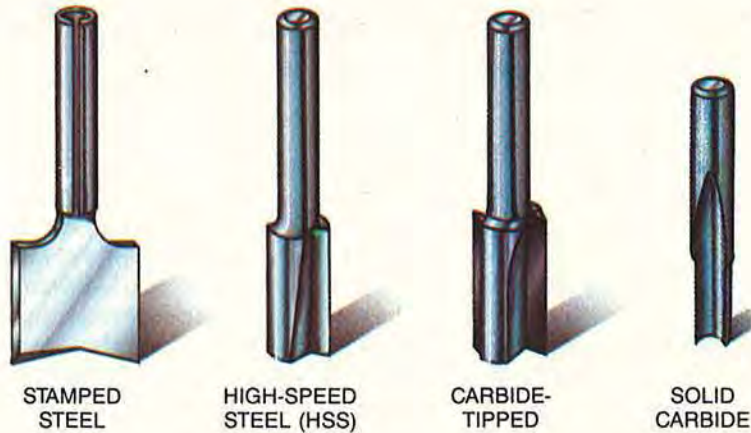

fast as a single flute, but leaves a smoother cut.

Another type of two-flute straight bit, the *spiral*, resembles a twist-drill bit, a feature that DML's Fred Garms says reduces chip accumulation and heat buildup. Due to its shearing action, the quality of the cut improves, but it cuts slower than other two-flute bits.

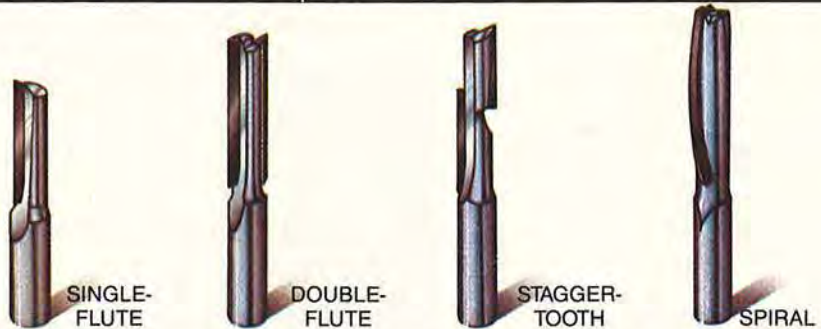

suggests buying an extra ball bearing when you purchase the bit so you won't have to interrupt a project in case a bearing fails. These bits come in diameters of 3/8" and larger.

Interchangeable-arbor or *assembled* bits also can fall into the edge-forming classification, although the cutter may be refitted and the pilot tip removed for groove-forming.

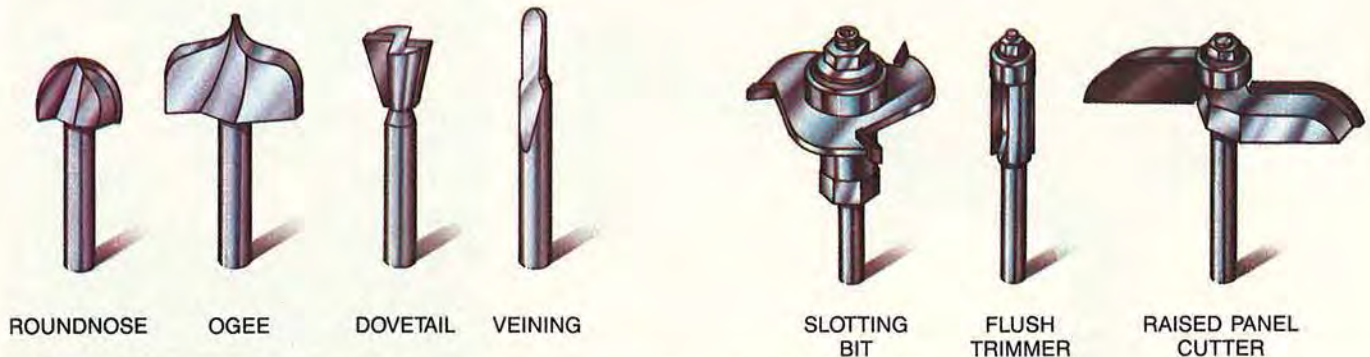
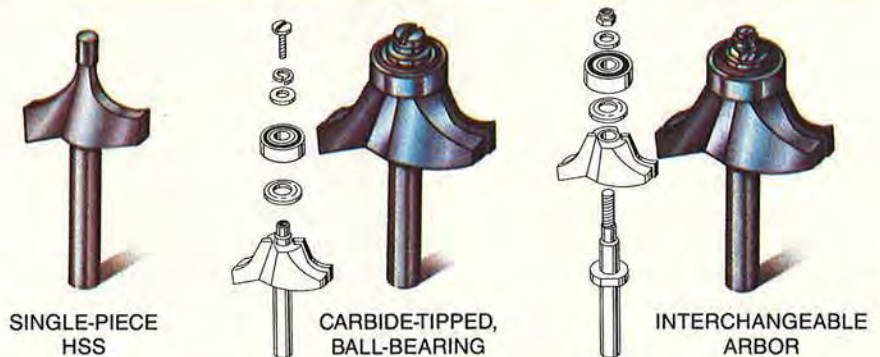

READERS,
IT'S YOUR
TURN!

PROJECT

A. PARQUET ON DISPLAY

Yep, woodworkers, that's oak parquet flooring you see on this coffee table—and it couldn't look nicer! *Walt Logel of Springfield, Missouri*, made optimum use of simple lines to highlight the parquet top.

Continuing the top's golden hue into the table's framework, Walt fashioned the sides and legs from oak. He used 1×3s for sides and 2½" squares for the legs, joining them with glue and dowels. The parquet was laid onto ½" particle-board with mastic. Measuring 38½×38½×16", the table has a polyurethane finish.

Walt keeps this table in his living room, but he also enjoys building furniture for family and friends. With work like this, we'll bet Walt has more friends than time.

B. COMPUTER/DRESSER COMBO

When your youngster adds a computer to his already jammed bedroom, what do you do? Pack his clothes under the bed? *Bud LaFever of Omaha, Nebraska*, considered the situation a design challenge: how to combine a computer and study area, plus clothing storage, in the space of a 42"-wide dresser. This photograph displays his ingenious solution.

Bud made the cabinet of ¾" lumber-core ash plywood and solid ash facing and trim. For the drawer sides, cabinet back, and top, he used fir plywood. Bud incorporated a computer compartment with a door that folds flat for a work surface and a "muffin" fan in the back panel to ventilate the computer and screen. Three drawers and two large cabinet spaces on top accommodate clothes.

The computer and storage center, finished with a dark walnut Minwax and polyurethane, stands 74" high, 42" wide, and 22" deep. "It took three weekends to complete," Bud says, "and fills a specific need like nothing available commercially."

C. WALNUT AND HOLLY NECKLACE

A member of the International Wood Collectors' Society, *Menalkas "Mac" Selander of Portland, Oregon*, puts much of his wood into jewelry. The retired commercial artist sells pieces, like the walnut and holly example shown at local craft fairs.

Mac is an apartment dweller, so his work area has to take up as little space as possible. He uses only hand tools to make and assemble the neckpieces once he's band-sawed

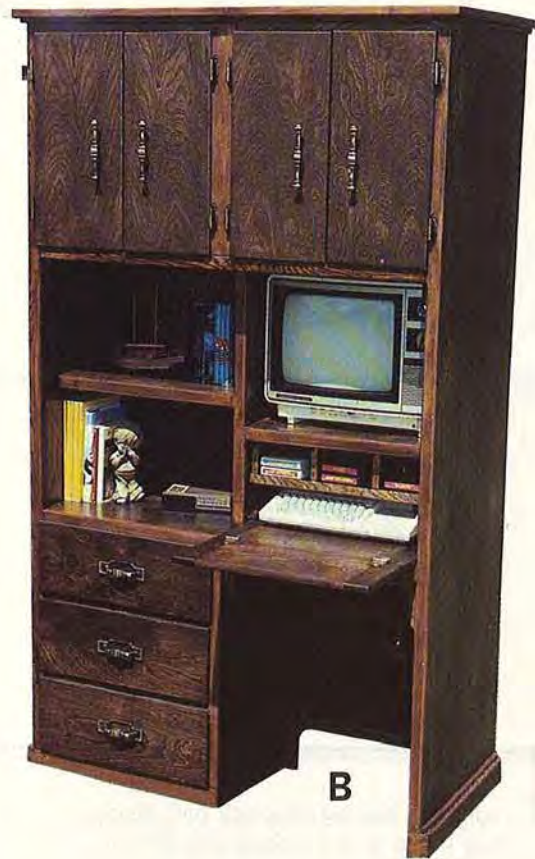

SHOWCASE

the stock to $\frac{1}{8}$ " thickness. Mac cuts out the wooden "petals" with a jeweler's saw and bores out the strand pieces with a No. 55 hand-drill bit. For a nongloss finish, he likes a first coat of Watco teak oil, then a second blended of Minwax Antique Oil and tung oil.

D. QUEEN-SIZE JEWELRY BOX

Woodworker *Rob Grant of Alexandria, Virginia*, creates custom wooden gifts on a part-time basis in his home shop. All his work, like

this jewelry box the size of a silverware chest, displays a contemporary flair, Rob tells us.

The box measures 21×11×6" and has two removable trays with individual compartments (32 in all) and a lower storage area lined in black velvet. Rob didn't divulge who he made it for, but the box's capacity indicates an oil heiress!

The case features dovetail joints, while end-lap joints form the lid. Except for the lid's cherry panel, the box features walnut, hand-

rubbed with oil, then topped with wax (the flush-fitting lid has no hardware, but lifts completely off).

Rob's finely crafted work didn't just "happen." Over the years he has earned a degree in industrial arts, taught an adult woodworking class, and been a member of the Washington Woodworkers Guild.

E. FIRST TIME, FIRST PLACE RACER

Eighteen-year-old *Sean Murphy of Des Moines, Iowa*, spent little time working with wood before he built this aerodynamic racer. Then, as a first-year student at the Kansas City Art Institute, his curriculum included an intensified woodshop course that familiarized him with tools and materials through designing and producing a project.

"I always admired fast, sleek cars," he says, "and some long, thin pieces of scrap looked about right." The 24" pine pieces, cut and glued up, became his speedster's body. From there, scrap pieces of walnut, birch, and oak were transformed into the engine, wheels, airfoil, and cockpit. In fulfilling the course requirement, Sean used practically every tool in the shop. Although he neglected to tell us what grade he received, to us, his race car rates first place.



To submit your projects . . .

Send a 35-mm color slide, with the project as the focal point and a simple background—no people. Include a capsule description—materials, special joinery, finish, and dimensions, for example. WOOD will pay \$25 for published projects. Slides cannot be returned unless you enclose a self-addressed, stamped envelope.

Project Showcase

Better Homes & Gardens®
WOOD magazine
Locust at 17th
Des Moines, IA 50336

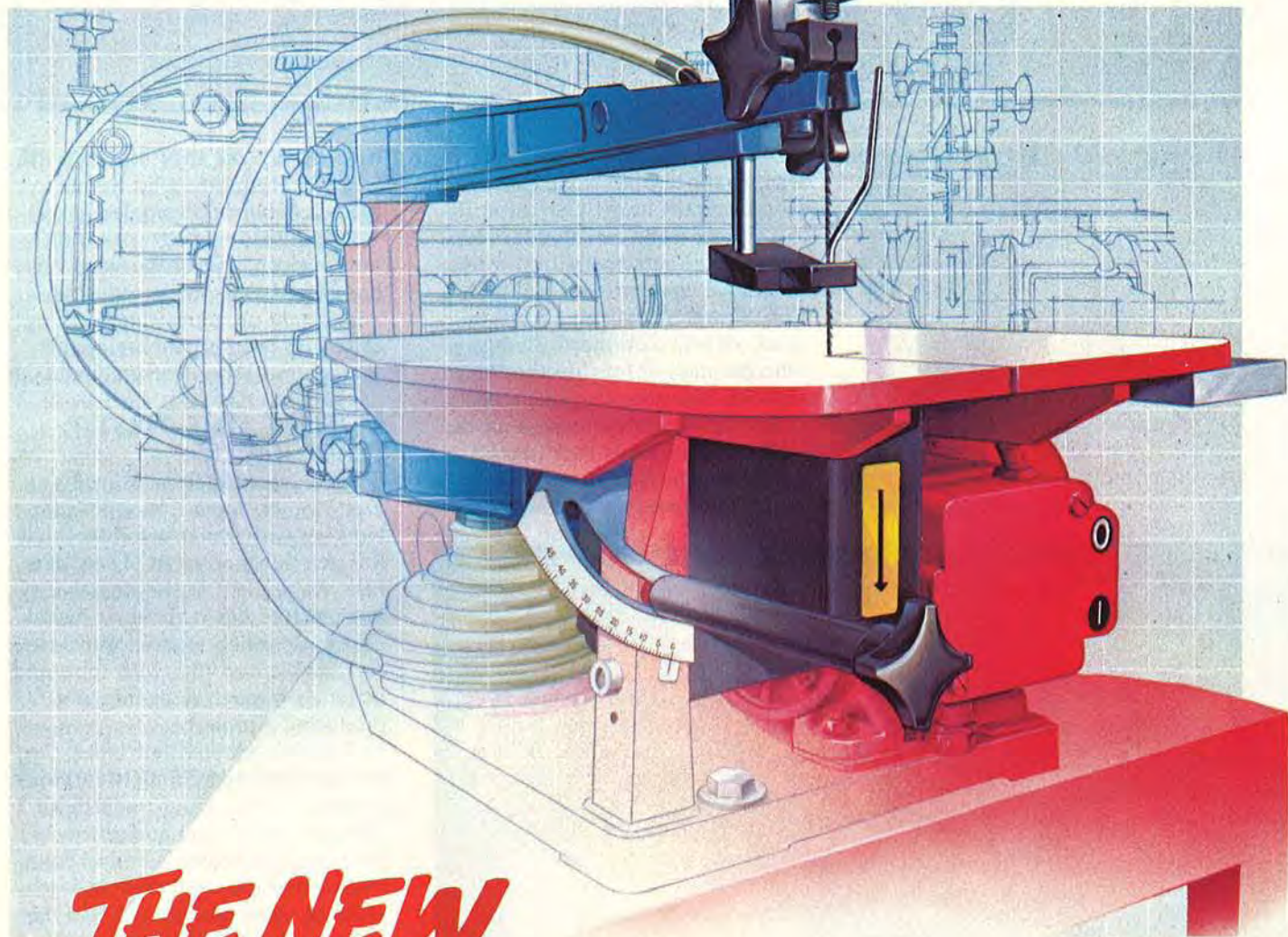

THE NEW CONSTANT-TENSION SCROLL SAWS

Great in a tight spot!

For most of us, the only exposure to scroll saws was an old-style, rigid-arm machine back in high school shop. We were not impressed. The rigid-arm design with its push/pull cutting action (see drawing, *opposite page*) did not change appreciably in 50 years. Although most of these saws were well built, they simply did not cut with enough speed or accuracy.

Then, in 1978, everything began to change. Hegner introduced its "constant-tension" parallel-arm saws

with pull/pull cutting action to the American market. The superior design of the Multimax-2 and the Polymax-3 renewed interest in scroll saws, both here and abroad.

Although they are based on an American patent for the "walking-beam" scroll saw from the 1870s (still manufactured by The Tool Company in motor- and pedal-powered kits), the Hegner models were the first in several decades to utilize the concept of pull/pull, constant blade tension. The Hegner

saws also reflected many design innovations that improved blade life and cutting characteristics.

Now it seems that Hegner and AMI (the sole U.S. importer) have convinced just about everyone (including competitors) that its constant-tension scrolling system can indeed perform with excellent results, even in materials up to 2" thick. From one brand and two models ten years ago, the selection has increased to eight manufacturers and 17 machines by 1985.

WHAT A SCROLL SAW CAN DO FOR YOU

For any kind of toy, puzzle, jewelry, or inside or outside fretwork (from veneers up to 2" materials), no tool can outdo the scroll saw. It is much safer than a band saw (or any other power saw), and you can spin corners as tight as the width of the blade.

Sure, a band saw is great for scrolling wider turns. And a hand-held jigsaw can make cuts in panels much too large for either type of stationary scrolling machine. But only the scroll saw gives you the fine detailing and intricate pattern-cutting capability made possible by the fine blades that this saw drives.

Other advantages are apparent, too. The modern scroll saw is a fairly small machine that can fit easily in an apartment or small home where other power tools cannot. You can learn to use the constant-tension scroll saw quickly. And it's one of the quietest of power tools, with little vibration and dust.

CONSTANT-TENSION VS. RIGID-ARM DESIGN

The old way: Drawbacks, with one advantage

With the original scroll saw, or jigsaw, design, the blade attaches to a drive piston under the table; the upper end attaches to a second piston tensioned with a spring. As the drive piston pulls the blade down in the cutting stroke, the upper piston spring compresses to provide force to pull the rather flimsy scrolling blade back up through the workpiece.

This push/pull blade drive and other features—such as fixed-blade locks, blade guides, and a simple up/down stroke—cause rapid blade failure with the resulting downtime, poor cutting and lots of cut marks. Further, such saws can handle only stock up to $\frac{3}{4}$ " with any finesse (hardwoods are a heartache).

However, this system has one distinct advantage over the new version: Most of these saws are designed with a removable upper arm. This feature permits the use

of files and small sanding blocks in the drive piston for fine perpendicular sanding of scrollwork.

The new constant-tension saw: No more "blade crash" and lots less sanding

Today's constant-tension scroll saws come in two basic types: the *parallel arm* and the *one-piece C-arm*. Although each type has a slightly different forward and back movement during the cutting stroke (most tools have a stroke length of $\frac{1}{4}$ " to 1"), their blades move in approximately the same manner.

The blade is held between the forward ends of the arms at a constant tension (about a "middle C" when plucked). In parallel-arm saws, this tautness comes from tightening a tensioning rod at the rear of the machine; in C-arm saws, you use a lever or knob mounted at the front of the upper arm.

Through an offset cam linkage between the motor and the lower arm, the two arms alternately pull the blade back and forth through the workpiece. The pull/pull action saves you from "blade crash," common in rigid-arm saws. This happens when the blade jams into the wood and the upper arm spring cannot pull the blade through. The motor then crushes the blade into the bottom of the work.

Due to the front/back horizontal as well as vertical motion of the constant-tension saw, the blade "rasps" on the sidewalls of the cut. This eliminates almost all of the teeth marks that rigid-arm saws and band saws leave behind. In some cutting situations, depending on the feed rate and the material type, a constant-tension saw can eliminate 90 percent of sanding time.

Of course, you can cut faster on a band saw than on a scroller. But even with a thin blade ($\frac{1}{8}$ "), a band saw *cannot* turn as sharply as the scroller. And the sanding time to eliminate band-saw teeth marks outweighs the cutting time lost on a scroll-saw (sanding isn't nearly as much fun as cutting anyway). Also, blade-change time is much less with a scroll saw.

SCROLL-SAW STYLES

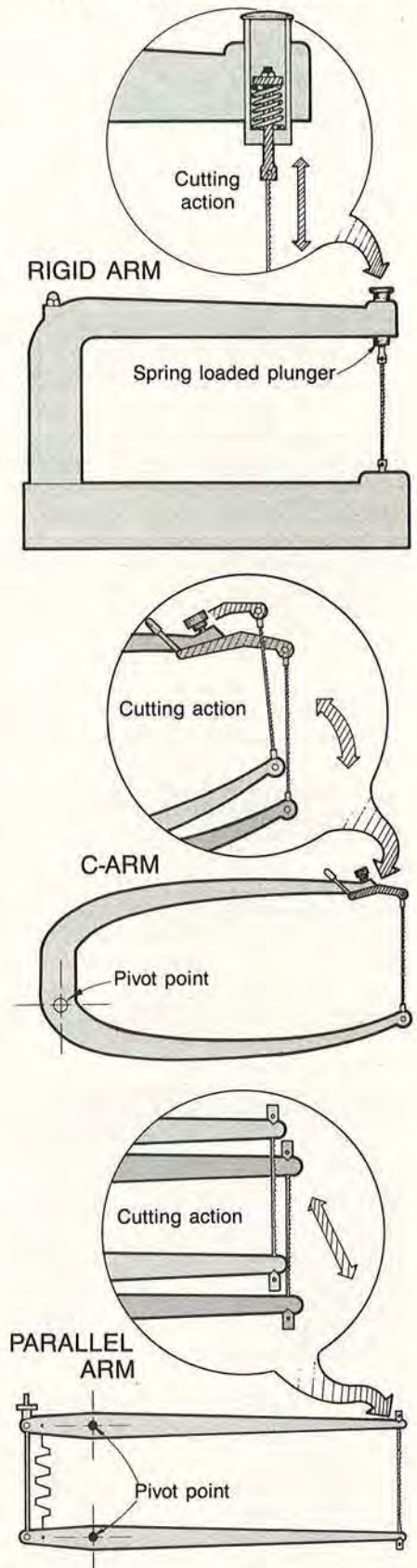

Continued

SCROLL SAW COMPARISON CHART

Manufacturer	Model No.	Arm Style	Throat Depth (in.)	Stroke Length (in.)	Strokes per Minute	Max. Cut. Depth (in.)	Table Size (in.)	(L)eft (R)ight Table Bevel	Machine Weight (lbs.)	Blade-Lock Style				Speed Control				MOTOR		B'RINGS.		OPTIONS	
										Blade-Lock Style	Blade Guard (Y/N)	Speed Control	Drive System	Type	Amps	Motor	Arm Pivots	Tie Rod to Motor	Light (Y/N)	Blower(Y/N)	Stand (Y/N)	Price	
AMT	4390	P	15	3/4	1725	2	8x17	L45°	42	S	N	N	D	I	2.5	S	S	B	N	N	N	\$ 200	
Delta	40-601	C	18	7/8	40-2000	2	16" diam.	L30° R45° U15° D30°	132 w/s	A	Y	E	D	DC	1.7	B	B	B/R	Opt.	Y	Y	\$1074	
Hegner	Hobbymax	C	14	1/3	1660	3/4	6 1/2 x 12	L45°	18	S	N	N	D	I/TEFC	0.9	B	SS	S	Opt.	Opt.	Opt.	\$445	
Hegner	Multimax-2	P	14 1/3	1 3/16	1660	2	7 x 15	L45°	28	S	Y	N*	D	I/TEFC	1.9	B	S	B	Opt.	Y	Y	\$894	
Hegner	Multimax-3	P	25	3/8 or 13/16	1200	2	10 x 20 1/2	L45°	66	S	Y	N*	D	I/TEFC	2.0	B	S	B	Opt.	Y	Y	\$1559	
Hegner	Polymax-3	P	19 3/4	3/16 or 1	700/1100/ 1270/1600	2	10 x 19	L45°	85	S	Y	B	B	I/TEFC	3.6	B	S	B	Opt.	Y	Y	\$1959	
Humfrey	Excalibur II	D	19 1/4	3/4	400/800/ 1400	2	12 x 17 1/4	L/R45°	50 l/mtr.	F	Y	B	B	Optional		B	B/S	B	Opt.	Y	N	\$495 l/mtr.	
Humfrey	Excalibur 24	P	24 1/4	3/4	600-1800	2	14 x 24	L45° R20°	110	A	Y	E	D	DC	2.4	B	B	B	Opt.	Y	Y	\$1285	
RBI	Hawk 12	P	12	5/8	1725	2	11 x 16	Fixed	48	S & A	N	N	D	I/TEFC	1.8	B	S	B	Opt.	Opt.	N	\$ 349	
RBI	Hawk 14	P	14	1 1/16	1720	2	10 1/2 x 21	L/R45°	73	S & A	N	N	D	I/TEFC	1.8	B	S	B	Opt.	Opt.	Y	\$ 499	
RBI	Hawk 20	P	20	1 1/8	695/1110	2	14 1/4 x 25	L/R45°	97	S & A	N	B	B	I/TEFC	1.8	B	S	B	Opt.	Opt.	Y	\$ 699	
RBI	Hawk 26	P	26	1 1/16	500-1650	2 1/2	14 1/4 x 24	L/R45°	138	S & A	N	E	D	DC	1.8	B	S	B	Opt.	Opt.	Y	\$1299	
RBI	Eagle	C	16	1 1/8	695/1110	2	14 1/4 x 25	L20° R45°	77	S	N	B	B	I/TEFC	1.8	B	B	B	Opt.	Opt.	Y	\$ 849	
Sears	2076	P	18	7/8	1700	2	9 x 14 3/8	L/R45°	26	S	Y	N	D	I	2	B	B	B	N	Y	Opt.	\$ 250	
Tool Company	Velocipede 2	WB	24	1 1/8	Var.	2	20 x 32 1/2	Fixed	50	A	N	Pedal drive						D	N	N	Y	\$ 600	
Tool Company	Kit saw #3+	WB	24	1 1/8 or 5/8	800	2	20 1/2 x 31 1/2	Fixed	10++	A	N	Optional						D	N	N	Opt.	\$ 160	
Woodmaster	1600	P	16	1 5/16	1725	2	9 3/4 x 15 5/8	L/R45°	70	S	Y	N	D	I	1.8	B	S	B/S	Opt.	Opt.	Y	\$ 649	

Arm Style

P=Parallel
D=Double parallel link
C=C-arm
WB=Walking beam

Bearings

SS=Spring steel plate
B=Ball
S=Bronze sleeve
D=Delvin sleeve
R=Roller

Blade-Lock Style

S=Separate pivoting clamp
A=Attached pivoting clamp
F=Fixed clamp

Motor Type

I=Induction
DC= Permanent magnet DC, totally enclosed
TEFC= Totally enclosed, Fan cooled

Speed Control

E=Electronic
B=Belt
N=No

Drive System

D=Direct
B=Belt

- * Electronic speed control optional
- Prices include shipping and handling
- + Also available as kits #1, 2, 4
- #1 Includes stand, table, motor—\$375
- #2 Includes stand, table—\$300
- #4 Includes stand, table, no arms—\$130
- ++ Weight of kit parts only

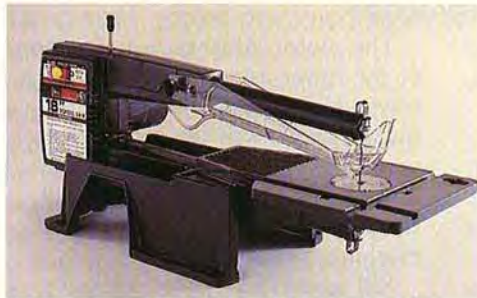

Sears



Hegner Hobbymax



AMT



Excalibur II



Hegner Multimax 2



Woodmaster with optional lamp



Delta Electronic



RBI Hawk 14



RBI Eagle



Excalibur 24

GRIPPING THE BLADE WITH PIVOTING CLAMPS

One of the main reasons for blade failure in rigid-arm scroll saws is the fixed-blade clamps: The thin scroll-saw blade tends to bow back as you push it through a piece of wood. With the ends of the blade solidly locked in immovable clamps, the blade cannot flex without bending at the clamp, causing metal fatigue and breakage.

In all but one of the "new breed" of scrollers, the blade attaches to the moving arms with pivoting blade clamps. These clamps are either pinned to the ends of the arms (as in the Delta, Excalibur 24, RBI Hawk, and The Tool Company models) or they are separate, attached to each end of the blade and resting in grooves in the arms (AMT, Hegner, Sears, and Woodmaster). The one exception to the pivoting blade-lock assembly is the Excalibur II, which utilizes rigid-blade clamps instead.

Pivoting-blade clamps rock in their "cradles" as the blade warps back, giving the blade an even curve that reduces the stress on the fine steel shaft. Two results occur: One, the blades break less often and, two, you can force the saw to cut faster with less blade damage. True, scroll saw blades are quite inexpensive (about 17 cents each, on the average), but the downtime while changing blades and threading back through gets annoying.



Changing the blade on the Excalibur 24

The Delta and Excalibur 24 furnish a locking pin that holds the swinging blade clamp stationary while changing the blades. Without this feature, the clamp twists up against the arm as you torque the locking screw.

Continued

In the machines that have removable blade clamps, you must hold the clamps in a vise or some other holder while you tighten and loosen the lock screw. In Hegner and RBI Eagle models, a simple, timesaving blade-clamp holding device is cast into or screwed onto the table. Hegner also offers an optional four-wing thumb setscrew instead of the hex-cap screw. Although we liked the convenience of not fumbling with a hex wrench, you may find it difficult to apply enough pressure.



Hegner's handy blade-clamp holders



Sears built-in blade clamp holders for precise distancing

Sears goes one step further by building holders for both ends of the blade clamps into the casting. This lets you position the blade with the same distance between the clamps each time. The Sears blade clamps are also designed so you can turn the blade 90° to the arms, but we have reservations about the way it cuts due to the slight rocking motion of the blade.

Here's a tip: If you have a saw with *loose-blade clamps*, purchase an extra pair or two and set up more than one blade. It's a good idea, especially if you want to change blade sizes while cutting a single piece.

PARALLEL ARM SAWS: HOW THEY WORK

Most of the constant-tension saws being marketed today are parallel-arm versions (see the Buymanship Chart on page 56). Two essentially identical arms, one above the table and one below, attach to a bracket with pivot points that are vertically aligned.

The tandem movement of these arms keeps the blade perpendicular to the table as it raises and lowers; it also causes the blade to move forward on the down (cutting) stroke in a slight chopping action, and backward on the upstroke. This translates into faster cutting action—not only because of the chopping, but also because the sawdust can fall out of the cut as the blade moves back. A clean kerf and blade gullets mean cooler running with less blade stress and wood burn. Still, as you turn tight corners and spin the workpiece completely around the blade, the walls of the cut remain almost perfectly at the angle set on the table.

The motor attaches near the front of the lower arm in one of three ways. Hegner and AMT use a short tie rod with the motor just under the right side of the table. This allows for only left table tilt, but it also means a more compact machine.

RBI and Woodmaster use essentially the same system, but with a longer tie rod that allows the motor to be installed far enough from the table to allow for two-way tilt.

The Excalibur 24 uses a variation of those systems. Rather than a tie-rod bolted to the side of the offset cam, you'll find a tie-rod *over* a camshaft, much like a piston tie-rod found in an automobile engine. This makes for smooth and quiet scroll-saw operation.

The Hegner Polymax-3 and the Excalibur II use a belt-drive system that keeps the linkage short and simple, yet allows for some speed change. (See the section of this article on speed control)



Long tie rod with motor mounted below base in Woodmaster (note also the two-way tilt table)

THE C-ARM SAW'S ROCKING ACTION

C-arm design resembles a tuning fork—one piece with a single pivot point either in the center of the C, as in the RBI Eagle, or offset toward the bottom, as in the Delta or the Hegner Hobbymax. The action of the blade in this saw is more of a rocking motion since the two ends of the single curved arm pivot at the same point.

The central pivot point of the Eagle tips the blade slightly forward at the bottom of the downstroke and slightly back at the top of the stroke. This causes a small but visible bowing of the cut if you turn corners too quickly.

The Delta has a pivot point offset toward the bottom of the C-arm at about table level. This way, the upper end of the stroke tilts back further than the central pivot sys-



The short-stroke Hegner Hobbymax uses a spring steel plate as a pivot point for the C-style arms.

tem, but the blade is nearly perpendicular at the bottom of the stroke.

The Hobbymax has an even-lower pivot point; it also has a very short cutting stroke of about $\frac{3}{8}$ ". This tool is designed as a small, high-precision scroll saw for material of less than $\frac{3}{4}$ " thick. With such a short stroke, Hegner eliminated the need for bearings of any kind at the C-arm pivot point and instead used a short spring steel plate. The result: a good deal of rigidity in the arm for a small-scale tool.

Each of the three machines tensions somewhat differently. A short bracket attached to the front end of the upper arm holds the blade clamp and is tightened or loosened by a thumb screw. Delta chose to provide a thumb screw adjustment with a quick-release lever.



The Delta C-arm saw has an off-center pivot point at table height to keep the blade vertical at the bottom of the stroke.



The RBI Eagle C-arm has a centered pivot point above the table which causes the blade to tip slightly forward at the bottom of the stroke.

OTHER FEATURES TO CONSIDER

Hold-downs

Hegner, RBI Eagle, and Excalibur 24 (which also comes with two alternate hold-downs) use a single footed pad on only one side of the blade. That's fine for larger pieces and it does swing out of the way quickly for blade changes and some types of cutting. But it's not handy for tiny scrollwork. One of the best hold-downs is on the Delta C-arm. It's stout with a little springiness, and it goes down both sides of the blade (which helps a great deal with small pieces).

Dust blowers

Scroll saws produce a lot of fine, powdery dust that will quickly cover your cutting lines if the tool does not have some type of dust blower. Most saws that have a blower run the little air pipe down the hold-down clamp. If you don't use the clamp for some reason, the dust blower is out too. Hegner is the only company that installs their pipe in the upper arm of the saw, which ensures always blowing right on the blade line.

Hegner also uses a very simple bellows mechanism to move that air, as does Delta, Sears and the two Excalibur models. Woodmaster uses an aquarium pump to push the air; however, the design is being modified to accommodate a bellows.

Speed control

All scroll saw models except the Delta and Excalibur 24 use induction motors. The two exceptions have totally enclosed permanent-magnet DC motors, which accommodate variable speed much more efficiently than induction motors.

Hegner and RBI have totally enclosed, fan-cooled induction motors to keep out the fine dust that will eventually damage open motors. An induction motor does not lend itself to electrical speed reduction as easily as a universal motor. However, Hegner does offer it as an option at a premium.

The Hegner Polymax-3, the RBI Eagle, and the Excalibur II are belt-drive tools and allow the operator

Continued on page 74



EPOXY

THE "TOUGH-GUY" GLUE MOST WOODWORKERS NEVER USE

While epoxies have long been helping to keep the marine world afloat, their use in the home workshop has been minimal. Maybe epoxy just seems too costly and complicated for most woodworkers. But wait a minute! If you're building a project that requires an adhesive with high strength and weather- and moisture-resistance, or if you're bonding dissimilar materials, epoxy could be the wonder glue you've been dreaming about.

WHAT IS EPOXY, ANYWAY?

Epoxy, a two-part adhesive, consists of an epoxy resin and a hardener that must be mixed before use. In the home shop, epoxies are either the quick-set or the slow-set types. The big difference between the two is working time, or pot life. Seldom can you join an entire furniture project in a few minutes, making a slow-set epoxy the practical choice for larger projects.

● **Quick set**, or "five-minute," epoxy requires that you bond the mating pieces within a few minutes after mixing the resin and hardener. It hardens quickly; most of the bonding strength develops in less than 10 minutes. Quick-set epoxy proves perfect for fast home repairs, or when only a small quantity is needed. However, unlike slow-set epoxy, quick-set cannot be submerged in water for long periods of time without weakening.

● **Slow-set** epoxy allows you an hour or more of open working time and takes up to 24 hours or more to cure. It's slightly stronger than quick-set, too. Slow-set epoxies often provide the moisture barrier on the exterior of sailboats because of their water-resistance. We used epoxy to laminate the runners in our sled project (see page 44) to ensure that the lamination wouldn't split even in the wet snow.

HOW EPOXY CURES

The epoxy curing process is called—are you ready for this?—exothermic (heat-producing) polymerization. Polymerization, which differs from the loss of water or solvent common to the curing of most other glues, results in only minor shrinkage (0.04 percent). This makes epoxy an excellent gap filler.

Once the chemical reaction begins, polymerization continues nonstop until all possible chemical bonding has occurred. This characteristic accounts for its limited pot life. The resin-hardener mix has a viscosity slightly thicker than varnish and changes to an impermeable solid when completely cured.

The chemical reaction that occurs when you mix epoxy creates an electrostatic bond, almost like that of a magnet, to bond dissimilar materials such as metal to wood. The reaction differs from the mechanical bond of other wood-working glues in which the glue must be absorbed by the materials being joined. It's an important advantage that only epoxy can offer.

An epoxy resin mixed with a

hardener produces heat; heating the mixture can speed up the curing process. Conversely, the reaction can be slowed down by cooling the mixture. If you mix an epoxy on a hot day, you'll find that the reaction will take place faster, the pot life will be shorter, and the curing will occur more rapidly. On the other hand a cold shop extends pot life and curing time. If you need large quantities of epoxy, mix several small batches to avoid having the epoxy cure before you have a chance to use it all.

MIXING AND APPLYING EPOXY

Mixing proportions vary for the different types of epoxy formulas. Some mixtures require one-to-one ratios, while others call for up to five parts resin to one part hardener. Read and follow the manufacturer's directions explicitly!

Epoxies come in a wide range of dispensers—from twin hypodermics to larger containers with plastic dispenser pumps (see photo). The two types mentioned dispense a measured amount of resin and hardener. (Note: Pumps may not be fully primed on the first stroke.)

Be sure to wear disposable-vinyl gloves when working with an epoxy. While most people can handle epoxy without being affected, some develop an allergic reaction, especially after continual use. Wear gloves made from a solvent-resistant material, such as rubber, when cleaning with a solvent—not the same vinyl gloves worn when applying the epoxy. (The solvent may

penetrate the gloves, making the gloves act as solvent-holding bags on your hands.)

For the cleanest and most effective results, use separate containers for the hardener and the epoxy resin, and a third for the mixing. Use most epoxies in a room above 60° Fahrenheit (although some are formulated to cure in near-freezing temperatures). Mix the epoxy resin and hardener vigorously for several minutes to thoroughly blend the two for complete polymerization.

Epoxy isn't cheap. A gallon can cost from \$35-\$45, compared to \$20 for an equal amount of aliphatic resin (common woodworker's glue). That's why it's essential to mix only what you need. Apply the epoxy evenly to both mating surfaces. If you're doing a small, intricate item, a syringe works well. Unlike most woodworking adhesives, epoxy requires very little clamping pressure as long as you have even and complete contact between the pieces being laminated. In fact, overclamping may squeeze out the epoxy adhesive and can lead to a weak, epoxy-starved joint. *Continued on page 77*

EPOXY: 9 TIPS FROM OUR SHOP

- 1 Mix epoxy in disposable paper or plastic cups. Never use styrofoam—the heated reaction will melt the cup. Larger batches can be mixed in a metal can.
 - 2 Apply epoxy with a brush, spatula, or paint roller to avoid skin contact and to spread an even film on the surfaces being joined. For covering a large surface, pour the well-stirred mixture into a disposable roller pan fitted inside a paint roller tray.
 - 3 When the shop or epoxy is below the recommended temperature range for application, use a heat gun or hair dryer to warm the epoxy and the wood.
 - 4 When joining stock where there's an imperfect fit, use a thickening agent to prevent the epoxy from running out of the joint or gap before it cures. While colloidal silica has the best holding
- power, you can use other powders such as talc, sawdust, or flour.
- 5 If possible, wipe or scrape away excess epoxy after clamping. Cured epoxy is very hard and can be equally hard on cutting blades.
 - 6 Protect forms and other bondable surfaces with paste wax, polyethylene sheeting, or waxed paper.
 - 7 Applying epoxy to the thread of a screw before insertion will produce up to twice the working load as the same screw without epoxy. It will also prevent the screw from working loose.
 - 8 Mix sawdust of the wood being used (or a slightly lighter-colored wood) with epoxy for a color-matched putty.
 - 9 When using small amounts of epoxy from dispenser pumps (one pump or less), measure the hardener and resin in a graduated container to ensure the correct ratio.





People-pleasing Holiday Gifts

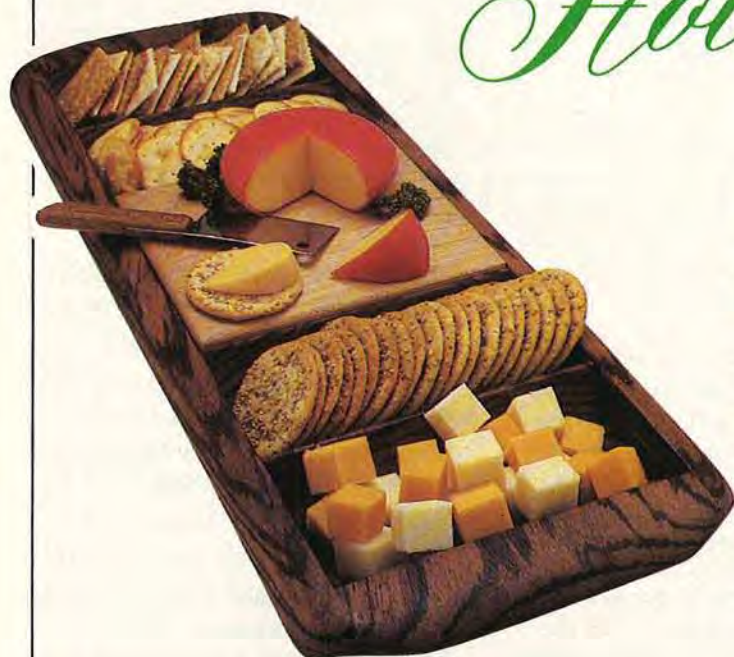

Zebrawood snack tray

For months we've been searching for the best gift project designs available to make your holidays—and those of your loved ones—as merry as can be. We're especially proud of this handsomely styled server. You'll be surprised at how easily—and quickly—this stunning gift goes together.

Note: You'll need some 1½"-thick stock to complete this project. You can either buy stock this size, plane thicker stock, or laminate two ¾" pieces together.

1 Rip and crosscut 1½"-thick stock to 8" wide by 24" long. Then rip a ¼"-wide strip from each edge of the stock to form the tray's center section (A) and the two edge strips (B). Be sure to keep track of which side of the center section each strip is cut—you'll be gluing the pieces together later.

2 Using the Side-Section Drawing as a guide, mark the location of the four pockets, the cutting board recess, and the handle reliefs on one edge of the center section. (To make it easy to accurately mark the pockets, we cut a 3⅞"-diameter template from hardboard, nailed a strip of wood 1" from the perimeter of the circle, and used it as shown

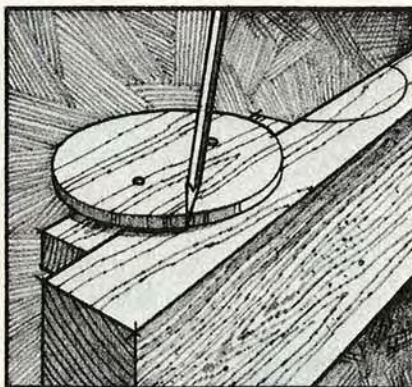

above. We also used the template to mark the handle reliefs.)

3 Band-saw the concave pockets and the handle reliefs to shape as shown in the photo, *right*. (We used a ⅜"-wide blade with 14 teeth per inch. And to keep the work-piece square as it passed through the saw, we clamped an L-shaped support to the stock as shown in the photo. You'll need to move the support several times to keep it on



the table; be careful not to cut into the clamp.)

4 Dado the cutting board recess ⅝" deep. (We used a radial-arm saw fitted with a dado blade.) Then bore a 1" hole through the center of the recess (this hole enables you to remove the cutting board easily when it needs cleaning).

5 Clamp the edge strips (B) against the edges of the tray they were originally cut from and trace the handle relief outline onto each end of both pieces. Remove the clamps and cut the relief in the end of each B.

6 Wrap sandpaper around the convex surface of the waste material from one of the pockets and use it as a sanding block to sand the pockets smooth. (If you plan to make several trays, you may want to invest in a 3×3" sanding drum that you can mount in an electric drill or drill press. See the Buying Guide for details.)

7 Glue and clamp the edge strips (B) to the center section (A), being sure that the handle reliefs align correctly. Using a damp rag, remove excess glue from the pockets immediately after clamping.

8 Rout the top and bottom edges of both edge strips with a 1/4" round-over bit. If you don't have a 1/4" bit, a 1/2" bit will do.

9 Mark both corners of each end of the tray as shown in the Top-View Detail, then cut the corners to shape. Sand a gentle downward curve at each end of the tray above the handle reliefs. Sand the entire tray smooth.

10 Cut the maple cutting board (C) to size. Then rout or hand-sand a slight round-over on its top and bottom edges.

11 Finish-sand the entire assembly and seal with a nontoxic oil. Position the cutting board in the recess, add some cheese and crackers, and you're ready to serve!

Project design: Warren Pardi
Photographs: Hopkins Associates, Bob Calmer
Illustrations: Bill Zaun

Bill of Materials					
Part	Finished Size			Material	Qty.
	T	W	L		
A	1 1/2"	6 1/4"	24"	zebrawood	1
B	1 1/2"	3/4"	24"	zebrawood	2
C	3/4"	5 15/16"	6 3/16"	maple	1

Supplies: nontoxic or mineral oil

BUYING GUIDE

● **3×3" Sanding drum.** Drill chuck-style drum has an arbor 3/8" diameter by 2 1/2" long. Stock #04Q23-ML. \$16.75 postpaid. We ordered ours from Woodcraft, 41 Atlantic Ave., P.O. Box 4000, Woburn, MA 01888 (800-225-1153). ■

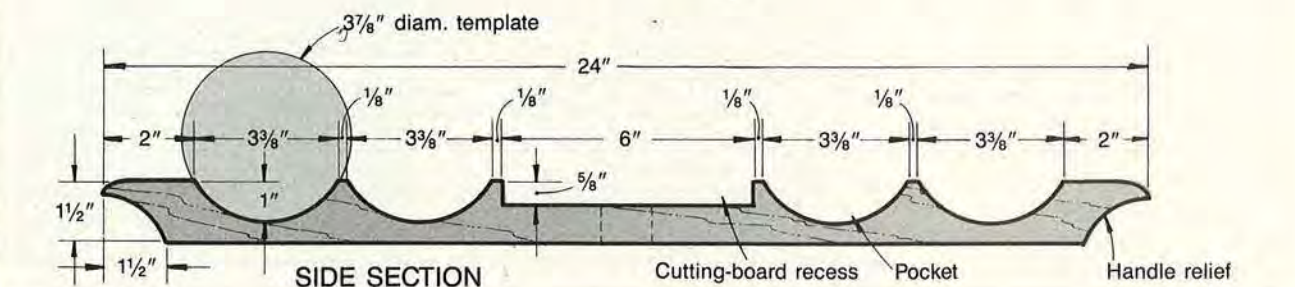
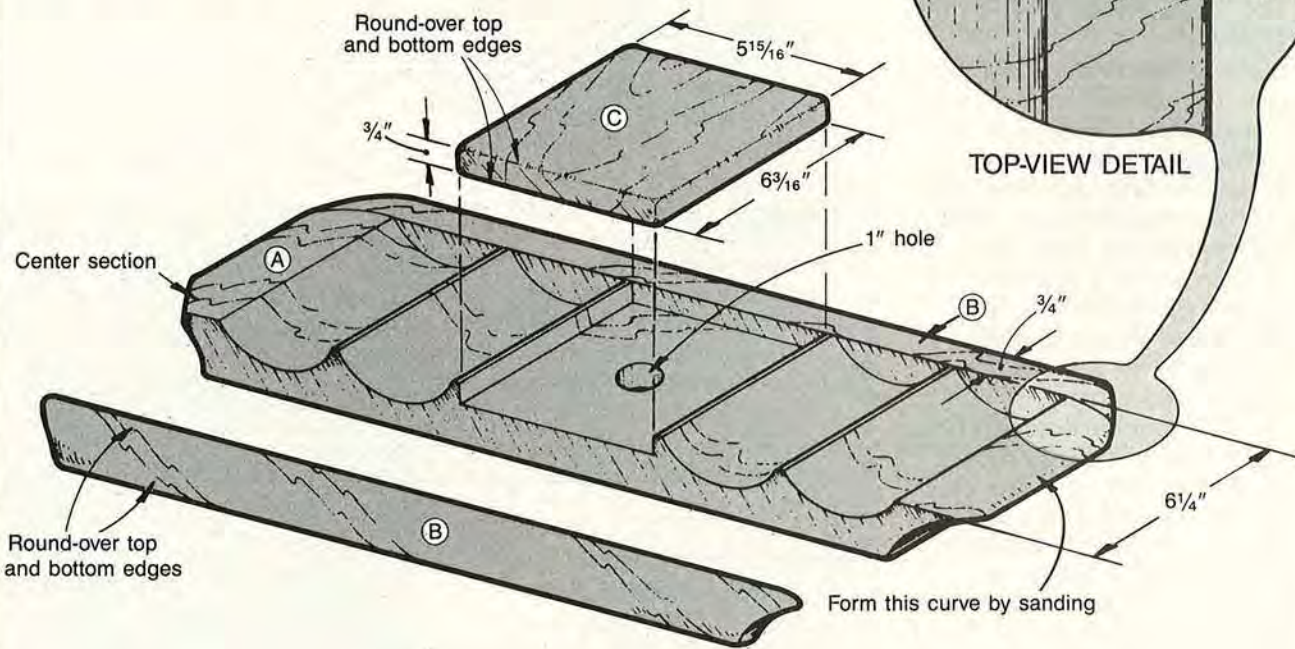
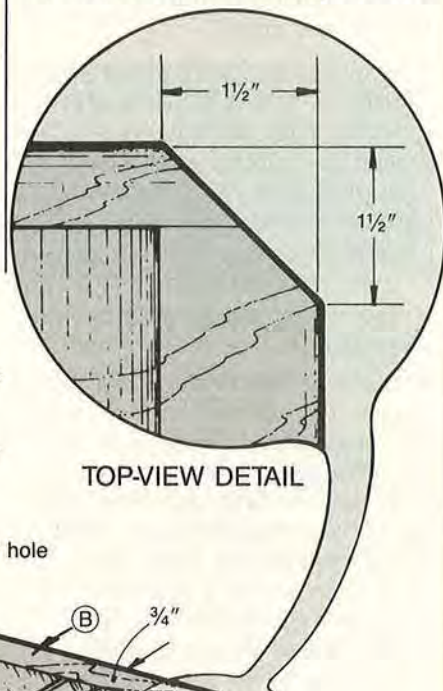

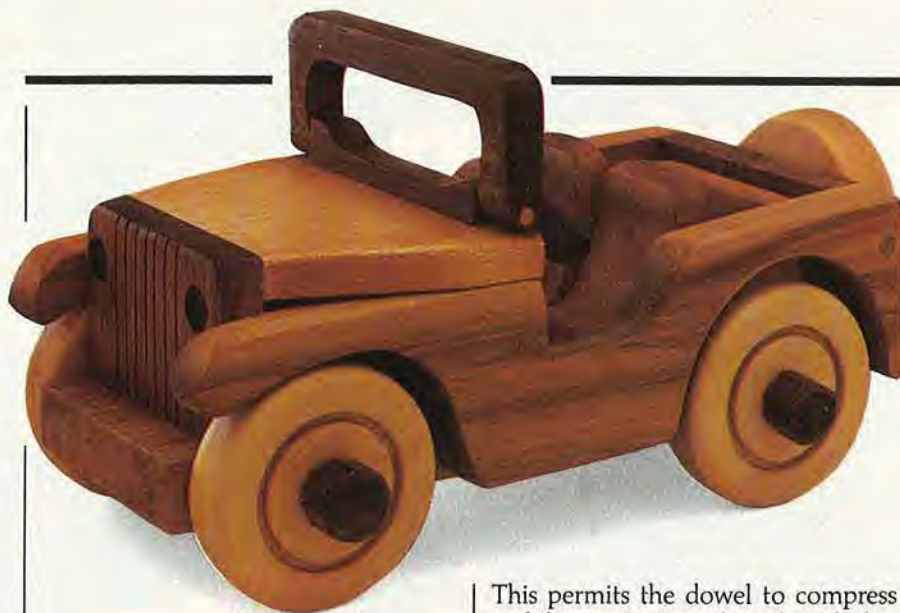

4 Rip a 12" strip of $\frac{3}{4}$ " walnut to $\frac{3}{4}$ " wide. Tilt your table-saw blade to 45° and bevel-rip each corner of the strip, using a push stick for safety. With a handsaw, cut the five $\frac{3}{8}$ "-long wheel hubs (C) from the strip. One at a time, hold each hub firmly in a handscrew and drill a $\frac{3}{8}$ " hole, $\frac{1}{2}$ " deep in the center.

5 Cut two $6\frac{1}{8}$ " lengths of $\frac{3}{8}$ " dowel for the axles. Using a saw with a fine-toothed blade, cut a kerf $\frac{1}{2}$ " deep in each end of each axle.

Bill of Materials

Part	Finished Size*			Material	Qty.
	T	W	L		
A	$\frac{3}{4}$ "	$3\frac{1}{2}$ "	$9\frac{3}{4}$ "	butternut	1
B	$\frac{3}{4}$ "	$2\frac{3}{4}$ " diam.		pine	5
C*	$\frac{3}{4}$ "	$\frac{3}{4}$ "	$\frac{5}{8}$ "	walnut	5
D	$1\frac{1}{2}$ "	$1\frac{3}{4}$ "	$2\frac{1}{4}$ "	mahogany	2
E	$1\frac{1}{16}$ "	$1\frac{5}{8}$ "	$3\frac{3}{8}$ "	mahogany	1
F	$\frac{3}{4}$ "	$2\frac{3}{8}$ "	$9\frac{3}{4}$ "	butternut	2
G	$\frac{3}{4}$ "	$1\frac{5}{8}$ "	$3\frac{1}{2}$ "	butternut	2
H	$\frac{1}{4}$ "	$1\frac{3}{8}$ " diam.		padauk	1
I	$\frac{1}{2}$ "	5"	$3\frac{1}{8}$ "	maple	1
J	$\frac{1}{2}$ "	$3\frac{1}{2}$ "	$2\frac{1}{8}$ "	walnut	1
K	$\frac{1}{2}$ "	$\frac{1}{2}$ "	$3\frac{5}{8}$ "	walnut	1
L	$\frac{1}{2}$ "	$1\frac{7}{8}$ "	$4\frac{7}{8}$ "	walnut	1

*This part is cut larger initially, then trimmed to finished size. Please read the instructions before cutting.

Supplies: $\frac{1}{8}$ " dowel, $\frac{1}{4}$ " dowel, $\frac{3}{8}$ " dowel, nontoxic oil finish

This permits the dowel to compress and fit snugly into the wheel hubs.

6 With a band saw, cut the front and rear seats (D and E) as shown in the Parts-View Drawing. Sand the seats smooth.

BUILDING THE BODY

1 Enlarge and transfer the shape of the sides (F) onto a piece of $\frac{3}{4}$ " stock, then cut the sides, fire wall, and tailgate (G) to size. Find and mark the center of one face of the tailgate and drill a $\frac{3}{8}$ " hole $\frac{1}{2}$ " deep for the spare-tire holder. Drill a $\frac{1}{4}$ " hole $\frac{1}{2}$ " deep at a 45° angle, $\frac{5}{8}$ " from the left end and near the top edge of the fire wall for the steering-wheel shaft.

2 Glue and clamp the body parts (F, G) together, removing excess glue once a tough skin has formed. Drill $\frac{1}{8}$ " holes $1\frac{1}{2}$ " deep in the jeep sides where indicated in the Exploded-View Drawing. Then, to strengthen the joint, glue the $\frac{1}{4}$ " dowels into place. Sand the dowels flush with the sides and carefully round off all the outside edges of the assembly.

3 Use $\frac{1}{4}$ " dowel centers to transfer the location of the $\frac{1}{4}$ " holes in the chassis to the underside of the body. (Make sure the back of the tailgate and the back of the chassis line up when you do so.) Drill the $\frac{1}{4}$ " holes $\frac{1}{4}$ " deep in both G's. Then, glue and insert $\frac{1}{4}$ " dowels $\frac{1}{2}$ " long in these four holes (this allows the body to be lifted off the chassis).

4 With the body mounted on the chassis, use the $\frac{1}{4}$ " dowel centers to transfer the location of the holes

already drilled in the chassis to the bottom of the seats. Now, drill $\frac{1}{4}$ " holes $\frac{1}{4}$ " deep in the bottom of the seats, and glue a $\frac{1}{2}$ " length of $\frac{1}{4}$ " dowel into each hole.

5 Drill a pair of $\frac{1}{4}$ " holes $\frac{1}{4}$ " deep in the top of the body where shown in the Exploded-View Drawing. (These holes will accept the hood assembly.)

6 Glue a $\frac{3}{8}$ " dowel $1\frac{1}{8}$ " long in the tailgate to hold the spare tire. Using a hole saw, cut the steering wheel (H) to size and glue it to a $\frac{1}{4}$ " dowel. Both the spare tire and steering wheel assembly are removable from the body.

CONSTRUCTING THE HOOD ASSEMBLY

1 Cut the hood (I), grille (J), and windshield parts (K and L) to shape. (See the Exploded-View Drawing for how to taper the hood. You'll need to enlarge and transfer the shape of parts K and L—see the Parts-View Grid Drawing for help with this.) Cut the saw kerfs and counterbore the headlights in the grill. Sand the parts (I, J, K, L) smooth.

2 Glue and clamp I, J, and K together. Once again using the dowel centers, transfer the location of the holes from the top of the body to the underside of the hood. (Make sure the back of the fire wall and the back of the hood align when doing so.) Drill $\frac{1}{4}$ " holes $\frac{1}{4}$ " deep and glue a $\frac{1}{2}$ " length of $\frac{1}{4}$ " dowel in each.

3 Clamp L in place, flat on the hood assembly, and drill $\frac{1}{8}$ " holes through L and $\frac{1}{4}$ " deep into the ends of K. Sand the bottoms of L in such a way that the windshield rests slightly angled back from center but will drop forward like the real ones. Carefully glue the dowels only into K so that the windshield will rotate freely.

4 Finish-sand the jeep and apply several coats of a nontoxic oil finish.

5 Assemble the jeep, fill 'er up, and take it out for a spin. ■

Project Design: Steve Baldwin
Photographs: Hopkins Associates
Illustrations: Bill Zaun, Kim Downing

New horizon desk set



Who wouldn't be tickled to receive this finely crafted desk set from your workshop? The wavy "horizon" design places this gift at the head of its class. One lamination yields enough of the horizon pieces for two complete desk sets.

LAMINATING THE HORIZON DESIGN

1 To make the lamination for the three desk items, start by cutting the maple (A) and walnut (B) to size as dimensioned in the Bill of Materials, plus 1" in length.

2 Bore a 1" hole $\frac{3}{8}$ " deep in the maple for the sun where indicated on the Lamination-Grid Drawing. Resaw a scrap of padauk to $\frac{7}{16}$ " thick and, using a 1" plug cutter, cut a plug for the sun (C). Glue the padauk plug in the 1" hole. After the glue dries, sand the plug flush.

3 Sketch a curved horizon line across the maple as laid out in the Lamination-Grid Drawing, being sure to bisect the padauk plug. (We give you the line patterns for our desk set, but don't be afraid to improvise. Any gently curved line will do.)

4 Temporarily attach the maple

atop the walnut with a few small beads of hot-melt adhesive or double-face tape. Joint the edges and trim the ends of the lamination to ensure that both pieces are perfectly flush.

5 Using a band saw with a $\frac{3}{8}$ " or $\frac{1}{4}$ " fine-toothed blade, cut the horizon line through the lamination.

6 Separate the maple from the walnut. (By matching each maple piece with its corresponding walnut piece, you'll end up with two horizon scenes, as shown in the Desk-Set Lamination Drawing.)

Note: The rest of this article explains how to make one complete desk set from one of the horizon lamination scenes.

7 Mark and cut the lower curved line through the walnut (see the

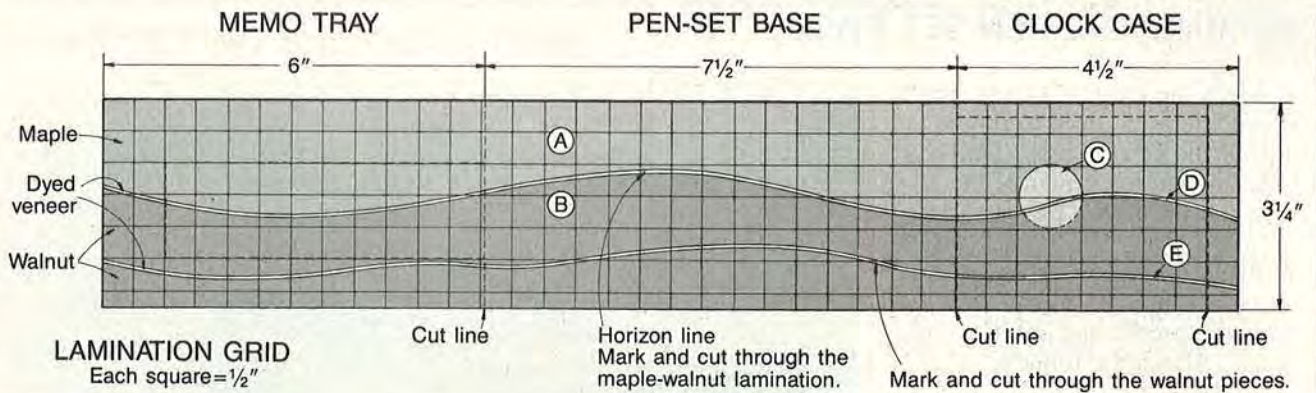

HOW THE DESK-SET LAMINATION STACKS UP

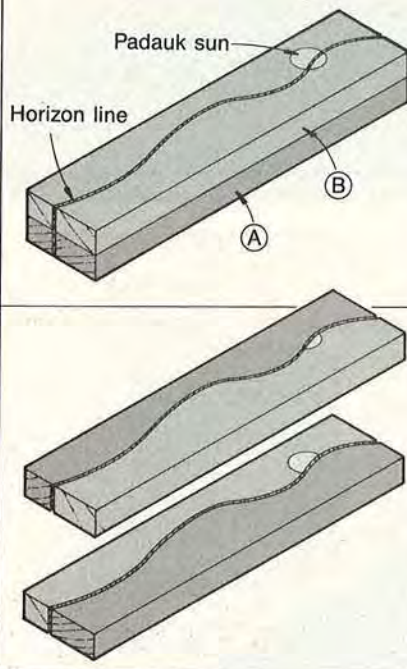

Bill of Materials

Part	Finished Size*			Material	Qty.
	T	W	L		
BASIC LAMINATION					
A*	3/4"	3 1/4"	18"	maple	1
B*	3/4"	3 1/4"	18"	walnut	1
C	7/16"	1" diam.		padauk	1
D*	1/28"	3/4"	18 1/4"	black veneer	1
E*	1/28"	3/4"	18 1/4"	green veneer	1
MEMO TRAY					
F*	3/8"	1 1/2"	5"	walnut	2
G*	3/8"	1 1/2"	6 1/4"	walnut	2
H	1/4"	4 1/2"	6 1/4"	plywood	1
CLOCK CASE					
I*	3/4"	3 1/4"	6 3/4"	walnut	2
J*	5/8"	1"	2 3/4"	walnut	2

*These parts are cut larger initially, then trimmed to finished size. Please read the instructions before cutting.

Supplies: hot-melt adhesive or double-stick tape

Lamination-Grid Drawing for the line's location).

8 Rip and crosscut two strips of veneer (D, E) as dimensioned in the Bill of Materials. (We used dyed veneers, but you could substitute two thin strips [1/16" or less] of different-colored woods. We cut the veneer with a straight edge and sharp X-acto knife.)

9 Glue parts A, B, D, and E together as shown in photo A below, keeping the ends and surfaces of A and B flush.

10 After the glue has thoroughly dried, scrape off the excess glue and protruding veneer. Plane or resaw the lamination to 3/8" thick. Sand all surfaces smooth.

11 Lay out and mark the sections for the memo tray, pen-set base, and clock case as dimensioned in the Lamination-Grid Drawing. Cut the three items to size.

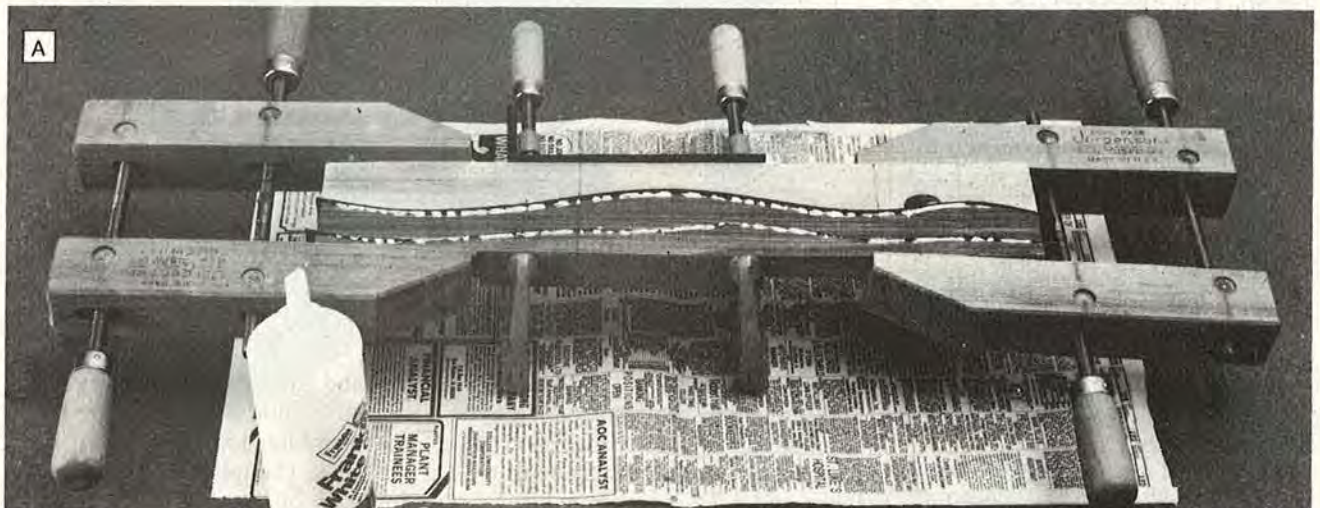

Continued

MAKING THE PEN-SET BASE

1 Mark the location of and bore two $\frac{1}{2}$ " holes $\frac{1}{4}$ " deep in the bottom of the pen set base. Drill a $\frac{1}{8}$ " hole through the center of the $\frac{1}{2}$ " hole and test-fit the pen funnels.

2 Remove the funnels and round-over the top edges by sanding. Sand the base smooth and apply an oil finish. Attach the funnels.

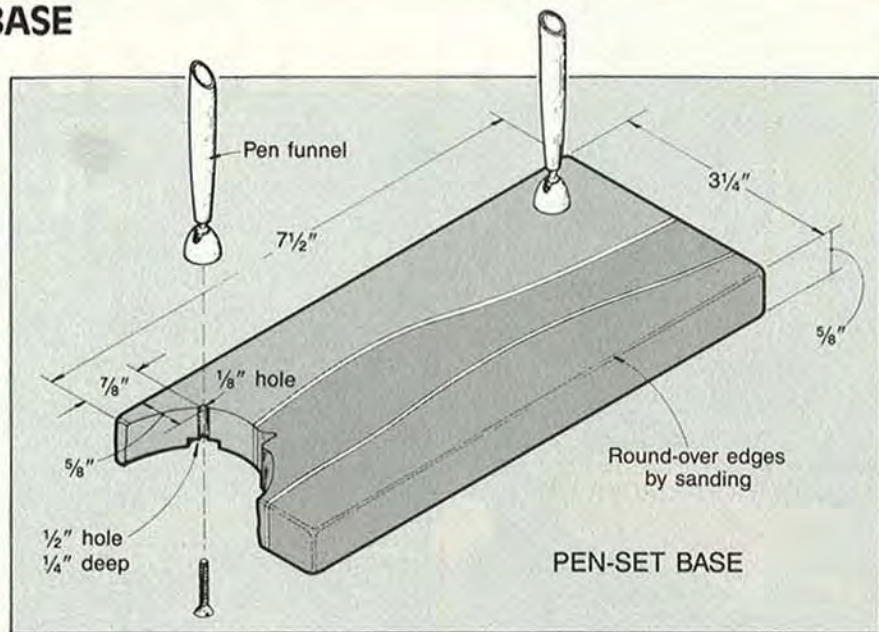

BUILDING THE MEMO TRAY

1 Rip and crosscut a piece of $\frac{1}{2}$ "- or $\frac{3}{4}$ "-thick walnut to $1\frac{1}{2}$ " wide and 25" long. Resaw or plane the walnut stock to $\frac{3}{8}$ " thick. (We planed ours to size, removing about $\frac{1}{2}$ " with each pass. We used a push block when moving the stock over the rotating-jointer blades.)

2 Crosscut a 14" section from the 25"-long piece. Cut a $\frac{1}{4}$ " dado $\frac{1}{8}$ " deep $\frac{1}{8}$ " from the bottom edge of the 14" piece. (We cut ours on a router table with a $\frac{1}{4}$ " straight bit.) Crosscut the front and back of the tray (F) from the remaining 11" section, and the two sides (G) from the 14" section.

3 Mark and cut a 3" radius on the front piece. Cut the bottom (H) to size from plywood or thin stock.

4 Glue and clamp the tray together, checking for square.

5 Reduce the $\frac{3}{8}$ " thickness of the memo pad lamination to $\frac{1}{8}$ " using a band saw or hand plane. (Due to its short length, we clamped the lamination in our workbench end vise and used a hand plane to reduce its thickness. Stock shorter

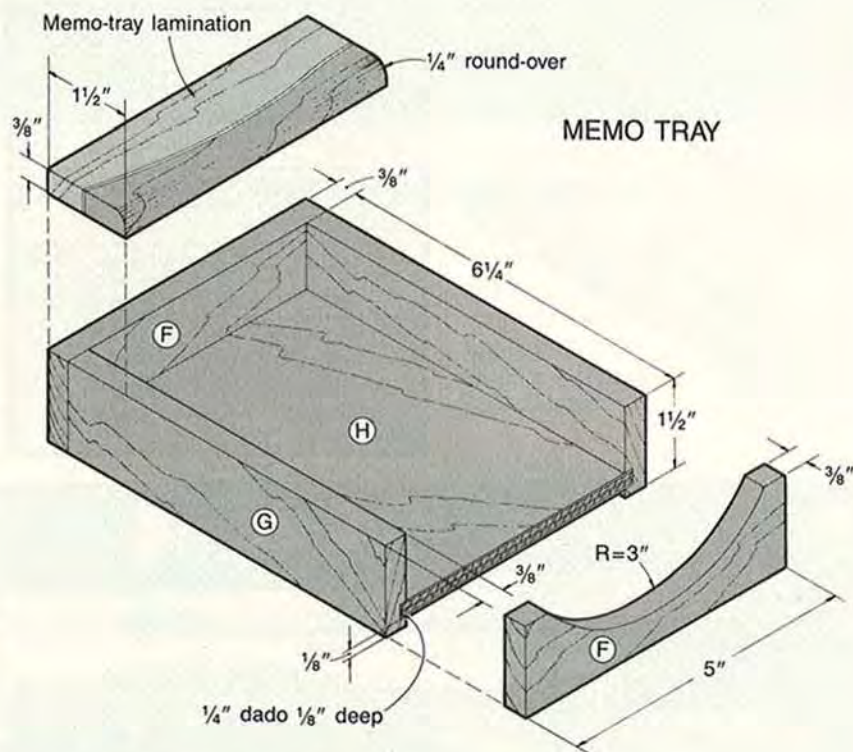

than 8" should *never* be planed on the jointer.)

6 Round-over the front edge of the lamination (you can either sand the edge or use a router table with a fence and a $\frac{1}{4}$ " round-over bit).

7 Sand the laminate and the tray smooth. Glue and clamp the two subassemblies together. Later, remove the clamps, finish-sand, and apply an oil finish.

CONSTRUCTING THE CLOCK CASE

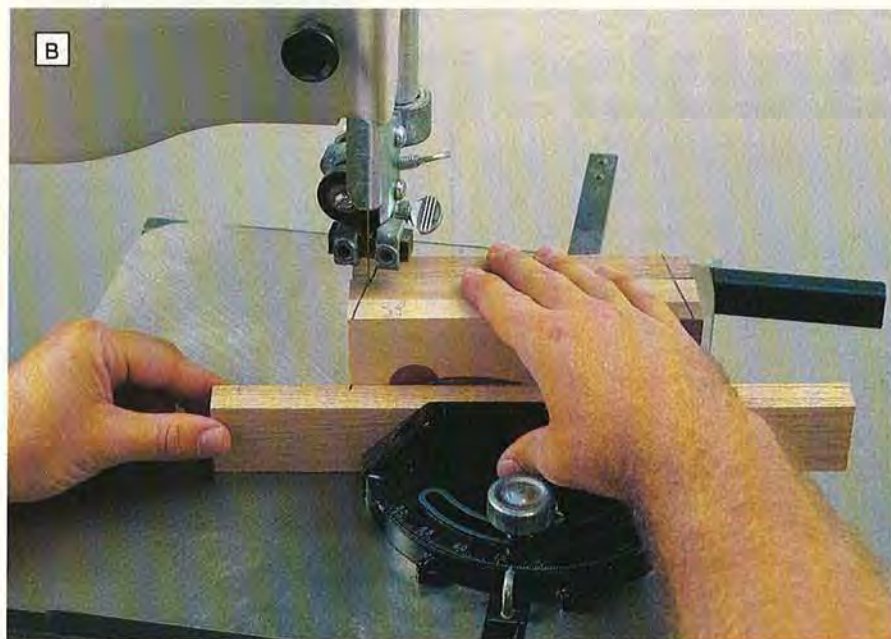

1 Rip and crosscut the walnut parts (I) to size. Then, rip and crosscut a $\frac{3}{4}$ " piece of walnut 1" wide by 12" long for the clock brackets (J).

Resaw or plane this 12" piece to $\frac{5}{8}$ " thick. Cut a $\frac{1}{2}$ " rabbet $\frac{1}{8}$ " deep the length of the piece. Sand a slight round-over on the outside edge of the rabbet. Cut this rabbeted piece into two $2\frac{3}{4}$ " lengths (J).

2 Glue and clamp the clock's parts together. Be sure to leave enough space for the digital clock. (We cut a scrap spacer the same size as the clock, inset it while clamping and removed it before the glue dried.)

3 Remove the clamps and mark the 10°-angled ends of the clock body. Bevel both ends on the band saw as shown in photo B at left.

4 Set the table saw blade at 10° from vertical center. Bevel-rip both edges of the clock body as shown in photo C at left.

5 Sand a slight round-over on the edges. Sand the clock body smooth and apply an oil finish.

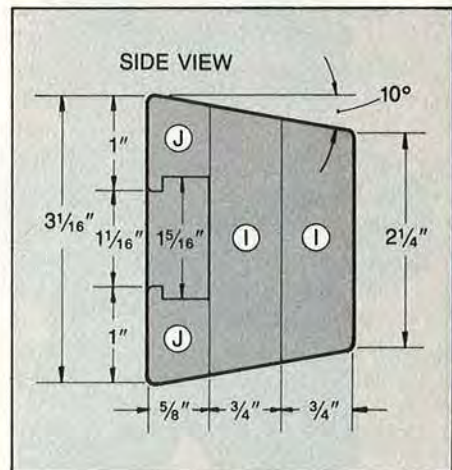

BUYING GUIDE

● **Liquid crystal (LCD) clock.** Stock #16011 (without alarm), \$5.95; #16002 (with alarm), \$6.50 (battery included). We ordered ours from Klockit, P.O. Box 629, Lake Geneva, WI 53147 (phone toll-free 800-556-2548).

● **Pen and funnel.** Gold colored, super deluxe. Stock #42004. Each pen including funnel, \$2.55 (\$5.10 per pair). Klockit (address above).

● **Color-dyed veneers.** Come in eight different colors in widths from 4" to 10" (minimum width of 4" for this project) and 36" long. \$1.25 per square foot. Jet Black stock #DV131 and Tropic Green stock #DV123. We ordered ours from Constantine, 2050 Eastchester Rd., Bronx, NY 10461 (800-223-8087). ■

Project design: Russ Peery
Photographs: Bob Calmer
Illustrations: Bill Zaun, Kim Downing

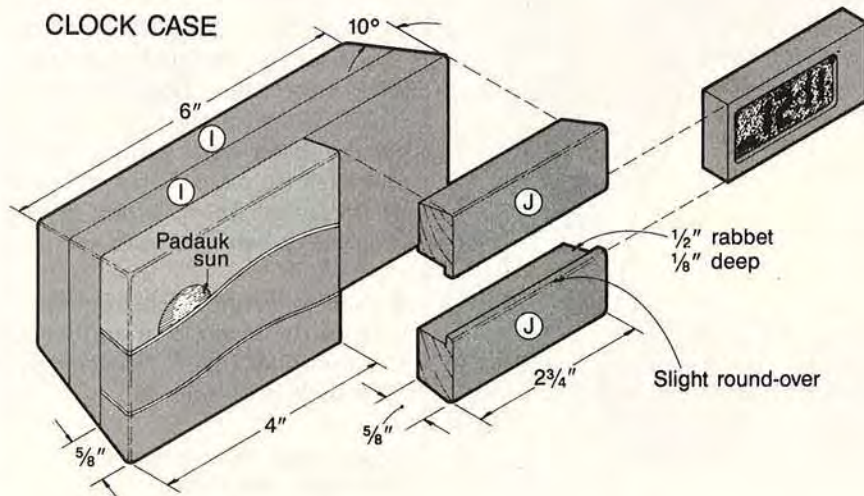

The 3 charm bears



Note: Choose clear, select pine for this project. A 3/4 x 10 x 18" board will yield the mama bear clothes hanger and the two dresser-top cubs.

Once upon a time, a woodworker like you decided to make a mama bear and two baby bears in her workshop. Then she found them a home in a very special youngster's room. Her "charm bears" took shape in less than an evening, but the smiles lasted a long, long time. . . .

- 1 Transfer the pattern for the mama bear onto 1" grid paper, then use carbon paper to transfer the pattern to the pine stock. Next, transfer the full-sized baby bear patterns, *right*, to tracing paper. Again, use carbon paper to transfer the patterns to the pine.
- 2 Use a scroll, jig-, or band saw to cut the outline of all three bears.
- 3 Drill 1/2" holes 1/2" deep into the mama bear's arms for the pegs.
- 4 Sand the bears smooth, then glue the pegs into the holes. (We used 2 1/2" Shaker pegs for the clothes hooks.) Stain the three bears.



BABY BEARS (FULL SIZE)

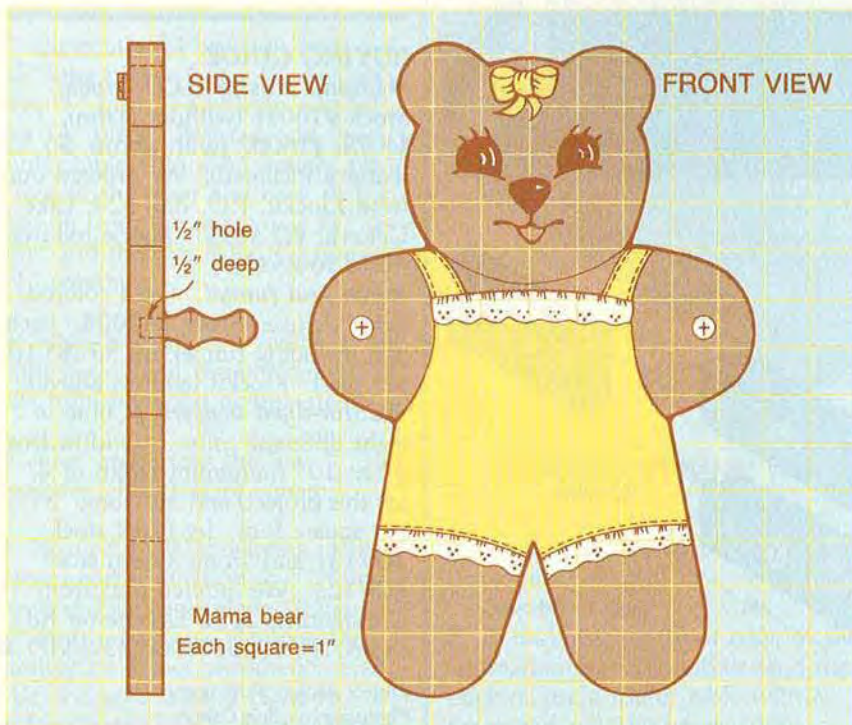
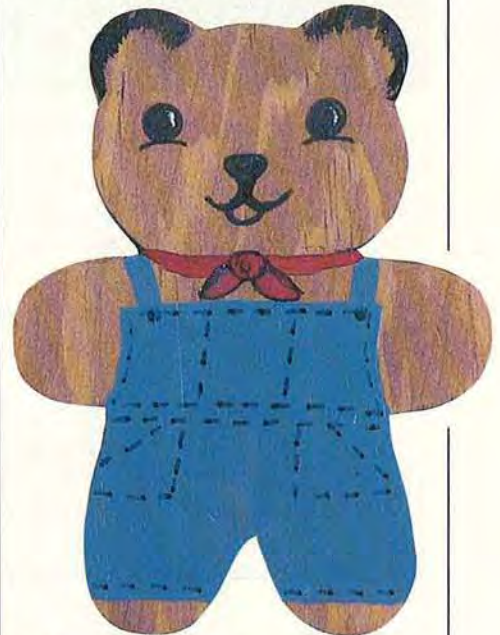

5 When the stain is dry, dress up your bear trio by painting on features and clothes. (We used acrylic artist's colors for the large areas, and did the detail work with a waterproof felt-tip pen.) Spray on a few coats of clear finish, letting dry completely between coats.

6 Nail a picture bracket on the back of the mama bear and hang. Use the other figures decoratively on a shelf or dresser. ■

Project Design: Marilyn Husted
 Photographs: Bob Calmer
 Illustration: Ron Chamberlain

'Just for her' necklace



Jewelry made of wood? You bet! This hardwood necklace will delight her and showcase your handcraft at the same time. We selected walnut and brass for our necklace, but don't let that limit your imagination. Use copper instead of brass for the inserts, or let the scraps of exotic woods you've been collecting determine the design.

- 1 Resaw, plane, or sand a 12" piece of scrap stock to $\frac{3}{16}$ " thick. (We used $\frac{1}{4}$ " stock and belt-sanded it down to $\frac{3}{16}$ ".)
- 2 Transfer the shapes shown below onto the stock. Locate and mark the holes for the metal inserts where shown in the Front-View Drawing. Then, drill $\frac{1}{8}$ " holes in the outline of four smaller pieces and a $\frac{1}{4}$ " hole in the larger center piece. (We found it easier and safer to drill the holes now, rather than after cutting the pieces to shape.)
- 3 Epoxy and insert $\frac{1}{4}$ " brass or copper tubing into the hole in the center piece and $\frac{1}{8}$ " rod into the

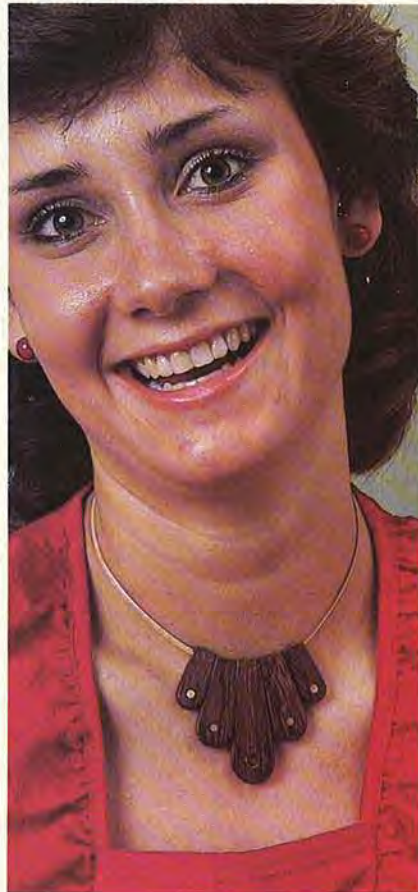

holes of the other pieces. After the epoxy dries, sand or file the metal flush with the wood.

- 4 Cut the five walnut pieces to shape from the 12" long stock. (We cut ours on a scroll saw; a band saw also works well.)
- 5 Drill a $\frac{3}{32}$ " hole $\frac{1}{8}$ " from the top in the edge of each piece to accept a strand of leather lacing (available at Tandy and some hobby stores).
- 6 Using progressively finer grits of sandpaper, sand the necklace pieces smooth. Round-over the top of each slightly to prevent it from irritating the neck when worn. Finish with tung oil. (We applied the oil and rubbed it in with our fingers to the desired sheen.)
- 7 Insert the leather lacing through the holes, cut to the desired length and tie behind the neck (or see a jeweler about obtaining a clasp). ■

Project Design: Dave Ashe
Photograph: Bob Calmer
Illustrations: Ron Chamberlain

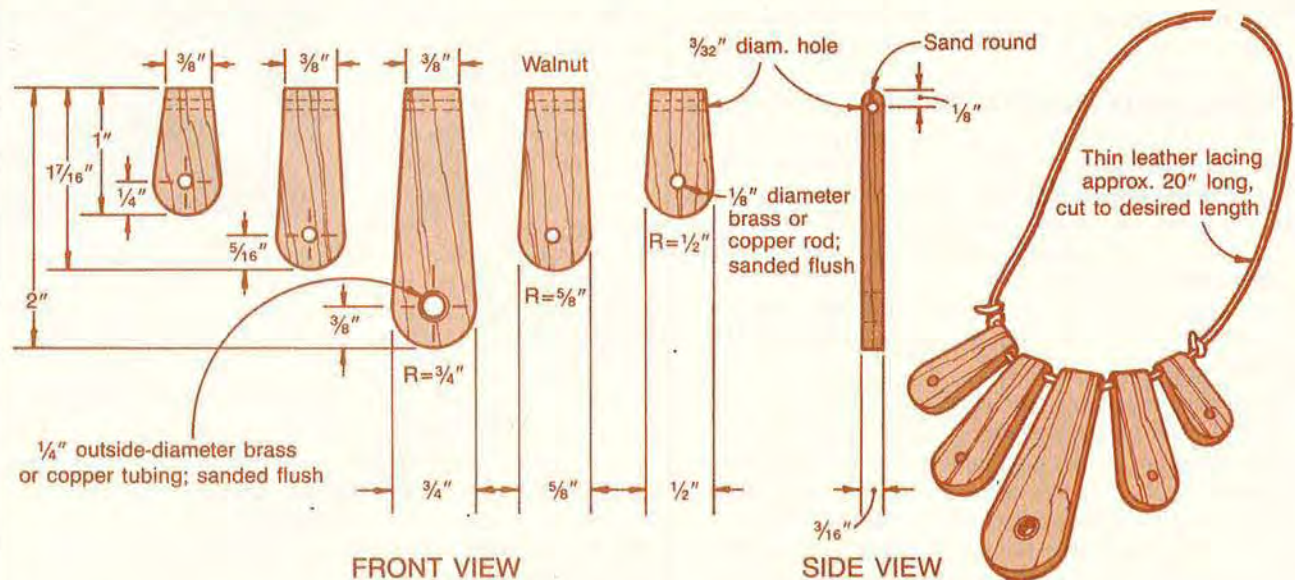

DESERT DAYBREAK

wall hanging

What painting could better capture the spectacular beauty of a desert sunrise than this project design does? Yet the palette here is a collection of thin-sawn woods, and you are the artist. It's a very special gift that someone in your life will treasure for years to come.

Note: You'll need some thin stock for this project. Refer to our Buying Guide following the last step for sources, or resaw your own.

BUILDING THE FRAME

- 1 Cut the hardboard backing A to size as dimensioned in the Bill of Materials.
- 2 Rip and crosscut two pieces of $\frac{3}{4}$ "-thick maple to 1" wide \times 48" long.
- 3 Cut a $\frac{1}{4}$ " rabbet $\frac{3}{8}$ " deep along one edge of each maple strip. Then, from each 48" strip miter-cut two frame pieces (one B, and one C) to length. (As always, test-cut scrap material first to ensure a 45° cut.)
- 4 Glue and clamp the frame pieces to the backing, checking for square. (We used web clamps to hold the frame together, and spring clamps to hold the backing in the frame.) When dry, remove the clamps and sand the frame smooth.

CUTTING AND ASSEMBLING THE SCENE

- 1 Transfer the Sunrise-Grid Drawing onto a $\frac{1}{2}$ " grid paper. Then use tracing paper to make a second full-sized pattern. (You'll need both patterns in order to cut all of the scene pieces from the stock.)
- 2 Cut parts D through H to length (32"). Then, sand the best surface of each.
- 3 Joint one edge of the poplar sky piece (D). Then rip D to size (6"). (The jointed edge of D should sit flush with top frame piece C.)
- 4 Use a pair of scissors to cut the sky piece from one of the full-sized patterns. Remove D from the frame and use spray-on adhesive to adhere the sky portion of the pattern to it. Cut the rays with a band or scroll saw fitted with a fine-toothed blade. Finish-sand the sky pieces (D), then glue them into position onto the hardboard. (We left a small gap at the cut lines to emphasize the sun's rays and to ensure that all the pieces



fit into the frame properly. We used woodworker's glue for adhering the pieces to the backing.)

- 5 Cut the cloud pattern from the other pattern, and glue it to the zebrawood (E). (We cut the pattern on a band saw as shown in the photo, below. Take care to support the long zebrawood piece when cutting; the cloud is fairly fragile.) Finish-sand the zebrawood.
- 6 Joint the bottom edge of H. Attach the patterns to F, G, and H, and cut them to shape. Cut only the top edge of the pieces; the bottom edge will be overlapped by the next layer of thin stock.
- 7 Remove the paper pattern from the pieces, then finish-sand.
- 8 Cut 1"-wide spacer strips from $\frac{1}{8}$ " scrap material. Glue the first layer of spacers to the hardboard, then glue the teak (F) in place on top of the spacers as shown in the Exploded-View Drawing. The teak overlaps the poplar about $\frac{1}{4}$ ", as shown in the Sunrise-Grid drawing. (We ran the first layer of spacers from the bottom of the poplar sky to the top edge of the bottom frame member. We cut the shorter spacers to fit between the bottom of F and the bottom frame member.)
- 9 Glue the padauk (G) in position so that it overlaps approximately $\frac{1}{4}$ " the bottom of the teak (F). Glue the purpleheart (H) into position overlapping the padauk. The jointed edge of the purpleheart should sit flush against the bottom frame member.
- 10 Cut the osage orange sun (I) to size and glue it in position on the poplar sky (D). (You may know osage orange as hedge apple in your part of the country.)





Bill of Materials					
Part	Finished Size*			Material	Qty.
	T	W	L		
A	1/4"	11 1/4"	32 3/4"	hardboard	1
B*	3/4"	1"	12"	maple	2
C*	3/4"	1"	33 1/2"	maple	2
D	1/8"	6"	32"	poplar	1
E	1/8"	3 1/2"	32"	zebra-wood	1
F	1/8"	4"	32"	teak	1
G	1/8"	4 1/4"	32"	padauk	1
H	1/8"	4"	32"	purpleheart	1
I	1/8"	1 1/4"	4 1/2"	osage orange	1

*These parts are cut larger initially, then trimmed to finished size. Please read the instructions before cutting.

Supplies: picture bracket, tung oil

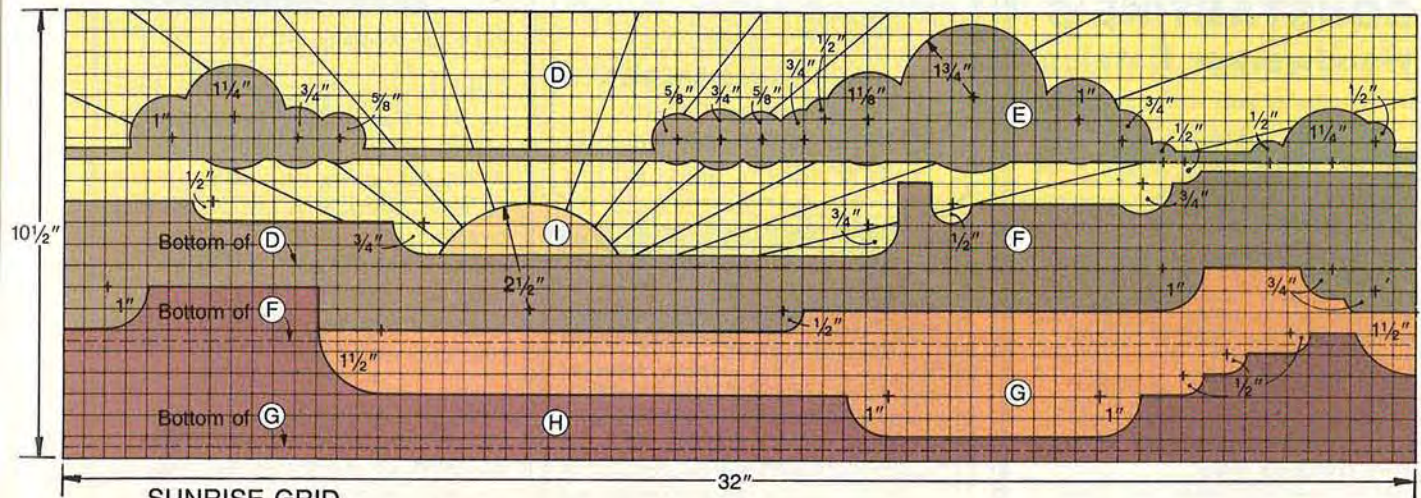

SUNRISE GRID
Each square = 1/2"

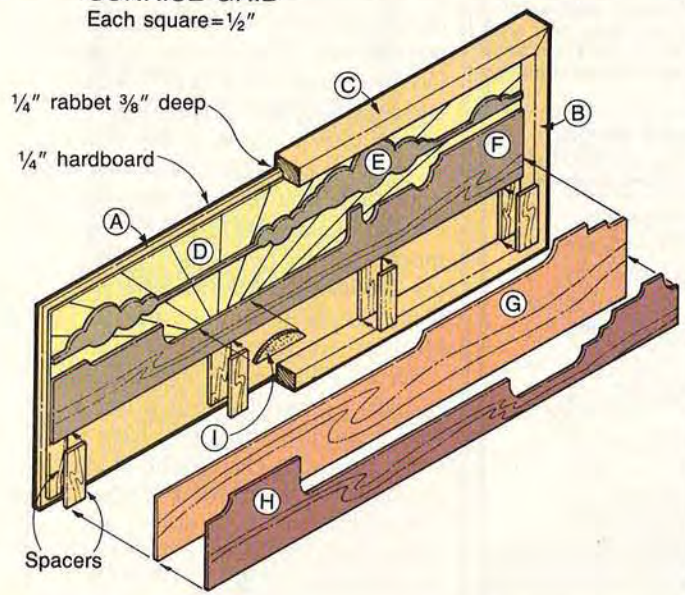

Glue the clouds in position on the sky.
11 Apply several coats of tung oil to all the pieces and to the frame. Attach a picture bracket to allow for hanging your work.

BUYING GUIDE

● **1/8" stock.** (When ordering, make sure you advise the supplier of the dimensions of the various pieces you need. Prices are per square foot.) Poplar, stock #W9740, \$1.29; zebra-wood, stock #W9381, \$3.59; teak, stock #W9301, \$4.55; padauk (vermillion), stock #W9001, \$2.75; purpleheart (amaranth), stock #W9001. We ordered the preceding stock from: Craftsman Wood Service, 1735 W. Cortland Ct., Addison, IL 60101 (312-629-3100). Osage orange, \$3 (call about availability before ordering). We ordered ours from: United States Mahogany Corp., 746 Lloyd Rd., Matawan, NJ 07747 (201-583-6300). ■

Project Design: C. L. Gatzke
 Photographs: Hopkins Associates, Bob Calmer
 Illustrations: Kim Downing

Do-it-Yourself
WOODWORKERS

You can build it
 cheaper than buy it...

You can restore
 & refinish it
 cheaper than hire it!

Here's
 every-
 thing
 you
 need



Mail
 Coupon
 for—

116 Pages

CONSTANTINE'S
Woodworker Catalog

IF YOU are at all handy with tools—or willing to learn in easy steps—here's the modern-day way to SAVE considerable sums of money. Build what you need. Restore and refinish what you own. Save on every project.

Everything you need—fine woods, veneers, specialty tools, wood finishes and how-to guidance—can be ordered by mail from Constantine. Read this partial list of CATALOG OFFERS: 14 kinds of cabinet & furniture woods, 90 veneers plus 19 flexible veneers to cover beatup or unpainted furniture. 76 inlays, 59 borders, 54 carving blocks, 118 carving tools & chisels, 32 upholstery tools & essentials, 39 clamps, 33 finished picture moldings, 72 lamp parts, 500 plans, 96 how-to books. Kitchen cabinet space-savers, carved molding, drill attachments, carbide saw blades.

ALSO: cane, fiber rush, reed. Period & modern hardware: latches, locks, hinges, pulls, escutcheons. Small-box hdwe. Framing clamps, wood-threading tools, angle-cutting jig, circle cutter, veneer saw, bow saw, mat cutter, miter trimmer, deep-throat fret saw. Turned, carved, square-taper furniture legs, wood bowl seal. Kits: gameboards, guitar, lazy Susan, furniture, clocks, coffee mill & pepper mill. Sliding & revolving hdwe. Plus page after page of useful products for shop, home and crafts.

Get \$2
 BACK

Mail coupon now for dollar
 Catalog. We include \$2 re-
 fund Certificate good on
 1st catalog order!

CONSTANTINE Est. 1812
 2054 Eastchester Rd., Bronx, N.Y. 10461

Send new Woodworker Catalog. \$1 enclosed.

\$2 Refunded

Double Your Money Back!
 \$2 Refunded on 1st Catalog order

Name _____

Address _____

City/State/Zip _____

CONCEALED HINGES
FOR WOOD AND GLASS
DOORS



- Largest Selection
- European (35mm)
- No-Bore For Glass
- Face Frame

Allen Specialty Hardware's emphasis is on MODERN hardware for craftsmen. European concealed hinges are our specialty, not a sideline. We offer the best selection, best quality, and most assistance in using them. Glass door hinges are available in either 2-pivot or no bore in nine styles. Make your kitchen cabinets more functional with wire shelves, baskets and slides. Build a computer cabinet using our TV extension slides. Our hardware for stereo cabinets includes everything from casters to lid hinges. No minimum order requirement and our prices are low.

STEREO AND KITCHEN CABINET HARDWARE
 BRASS HARDWARE • SPECIALTY ITEMS
 SLIDES • CATCHES • WOOD PULLS • ELEVATORS

MAIL ORDER ONLY—CATALOG \$1.00

ALLEN SPECIALTY HARDWARE
 DEPT. 6, P.O. BOX 10833, PITTSBURGH, PA 15236

QUARTZ

CLOCK MOVEMENTS
AND ACCESSORIES

- 5 YEAR GUARANTEE
- FREE Hour & Minute Hands
- 4 Shaft Lengths
 3/8" 9/16" 3/4" 7/8"

1 + \$5.80 5 + \$4.60 10 + \$4.20 25 + \$3.60

SECOND HANDS 1 + .30 50 + .25
 ADDITIONAL CHARGE FOR SHIPPING

PRECISION MOVEMENTS



2024 Chestnut St., P.O. Box 689
 Dept. G, Emmaus, PA 18049
 (215)967-3156



WOODWORKING
PATTERNS

Timbers catalog has hundreds of projects to make your wood-working easier and more fun. It shows designs for wooden toys, furniture, bird houses, gifts, whirligigs, clocks, planters and much more. There are pages of supplies like wood parts, brass hardware and tools, too! Build a project you can be proud of! Timbers catalog is \$1.

Timbers, Lake Tahoe
 Dept. T11, Carnelian Bay, CA 95711-0850

BUILD THIS SPACE SAVING
CORNER TRUNDLE BED

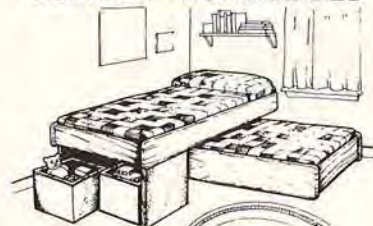

- EASY TO BUILD WITH
- READILY AVAILABLE MATERIALS
- CLEAN CONTEMPORARY DESIGN

#484 JEFF'S CORNER TRUNDLE BED

theWORKSHOP
BLUEPRINT COMPANY \$8.95

P.O. Box 65725
 West Des Moines, Iowa 50265

Plus \$1.50 Postage & Handling
 Iowa Res. Add. Sales Tax

TOOL BUYMANSHIP

SCROLL SAWS

Continued from page 59

to change pulleys to change the speed. Although not as handy or variable as a dial, belt-change speed control has the distinct advantage of giving more power to the blade the slower it moves.

The big advantage of the electronic-dial variable speed in the



RBI Eagle two-speed belt drive

Delta and Excalibur 24 is the ability to set an infinite number of speeds (this is especially helpful when cutting metals). If you want an exact speed that can be reset over and over, belt-and-pulley changes are the best. In either case, we found that in most cutting, the high-end speed of the machine works best.

PARTING ADVICE

Which machine is right for your shop? With prices ranging from \$150 to \$2,000, you've plenty to choose from no matter what your pocketbook. Decide your priority. Do you want a tool that you can take out of a box, set up and run for an hour a month or ten hours a day with consistent cuts, little downtime, and low maintenance? For the professional, where time is money, or the perfectionist, the top-of-the-line machines (like the Delta, Excalibur 24, and the Hegners) are a good investment.

Or do you want a machine that still gives good cuts, but is not as easy to use? Perhaps you have to work harder to change the blades or adjust the machine, but you can save hundreds of dollars by living with the inconveniences. It's your choice. . . . ■

Joint-Matic 4200



The Joint-Matic will help you produce woodworking pieces of elegance, precision and beauty more quickly and expertly than you ever thought possible. Now, in minutes make... Mortise, Tenon, Sliding and Through Dovetail, Box Finger Joint and much much more.

For Your Brochure Please Send \$2.00 to:

Strong TOOL DESIGN

20425 Beatrice
Dept. W
Livonia, MI. 48152

Joint-Matic Machine Is Protected By U.S. Patent 4,163,465

introducing...

MERLE®



The NEW
Adjustable
Corner
Clamp

PATENT PENDING

Some of its unique features:

- forces frames into perfect square
- holds frames in square for jointing
- handles frames from 2 5/8" x 2 5/8" to 12 feet around
- creates even jointing
- quickest way to clamp mitres
- adjustable clamping pressure
- sturdy cast aluminum and steel construction

CALL TOLL FREE 1-800-428-2222
(In PA 1-800-222-2292)

VISA or MasterCard accepted
or send check to:

INDUSTRIAL ABRASIVES CO.
P.O. Box 8611, Reading, PA 19603



THE Woodworkers ASSOCIATION

— INVITES —

Woodworkers interested in increasing their knowledge and enjoyment of their subject to send for details of this new association for the mutual benefit and enjoyment of all woodworking enthusiasts.

SEND FULL DETAILS of The Woodworkers Association:

NAME

STREET

CITY

STATE.....ZIP

SEND TO: The Membership Secretary,
Woodworkers Association, 166 High Street,
Lewes, East Sussex, England.

AMERICAN HERITAGE

Proudly Presents
THE HISTORY OF
CUT NAILS
IN AMERICA



20 unique nails
from pennyweight to penny,
artfully arranged in a
beautiful solid oak frame,
walnut stained with brass trim.

\$16.00 plus \$2.00
shipping
& handling

(Check or Money Order)

AMERICAN HERITAGE

Post Office Box 3444
Carson City, NV 89702-3444

SAVE UP TO \$500!

If you enjoy working with wood, there is an **alternative to expensive power tools. Gill-Blit kits!** Kits include patterns, parts, nuts & bolts - - all in numbered packages for easy construction. These are durable, high-quality tools that come with a five-year guarantee & continuous availability of replacement parts and supplies.

Kits or Plans with FULL-SIZED patterns:

- 12 or 18 in. Band Saw
- 10 in. Tilt/Arbor Saw
- Comb. Drill Press/Lathe
- 9 in. Tilt Table Saw
- 6 in. Belt Sander
- Spindle Shaper

To order kits or plans;
CALL (314) 724-1812,

Or send \$1 for catalog;
\$6 per plan to:

GILLIOM MFG., INC.

Dept. BH 11
1700 Scherer Parkway
St. Charles, MO 63303

the
American
Woodworker

Receive A Free Copy Of
The American Woodworker
1/3 Off Subscription Offer

If you enjoy woodworking, The American Woodworker is a must for you. It contains projects on three levels: beginning, intermediate and advanced. The plans alone are worth the subscription price. Our subscribers pay approximately 31 cents for each plan. Each project is well illustrated and photographed. Each issue is loaded with information showing in detail how to perform a specific woodworking operation, plus how to build time saving jigs and shop equipment that will save the woodworker hundreds of dollars. Informative articles explain how to compensate for the movement of wood, the basics of carcass construction, how to build a shop dust system for under \$300.00, etc. These are a few examples of the types of articles you can look forward to. Listed below is a summary of what to expect from The American Woodworker.

- Projects on 3 levels
- Large 9x12 size
- All different styles of furniture & projects
- A section on jigs
- Woodworking techniques
- A Question & Answer column
- In-depth instructional articles
- Supply sources, visits, reviews & much more

The American Woodworker is published quarterly in March, June, September, and December so each issue is the type of publication that you will save for years to come. The subscription price is \$10.00 per year, \$18.00 for two years. Subscribe today for two years and we will send you our current issue free. That's a savings of almost 1/3 off the regular price. If you are not satisfied, cancel your subscription and keep the current issue free. Outside U.S., \$14.00 per year, \$22.00 for two years, U.S. funds. You can subscribe for the next year for \$10.00, but your best buy is a two year subscription with a free issue. Imagine the next nine issues (including the Free Issue) for only \$18.00. That's over 72 projects and enough technical articles to fill a good sized text book. Subscribe today. Your satisfaction is guaranteed 100% or your money will be refunded on unmailed copies.

THE AMERICAN WOODWORKER

P.O. Box 1408, Dept. W-4
Hendersonville, TN 37077-1408

**AMERICA'S #1
LOG HOME COMPANY
SEEKS DISTRICT DEALERS**



Lincoln Log Homes, the leader in prefabricated housing, is offering a **PROTECTED TERRITORY** to approved applicants nationwide.

Unlimited Income Potential

Featuring:

- Solid 8" uniform treated logs.
- Log home packages that retail for \$8.50 per square foot.
- Optional factory assembly and erection on your lot.
- FHA and VA accepted
- Models available "in the dry" on your foundation for \$15.00 square foot.
- Two-day expense paid factory training.

**INVESTMENT 100% SECURED
BY MODEL HOME**

Individual selected must have ability to purchase or mortgage a \$17,000 model home.

Call Mr. Wood
(704) 932-6151 COLLECT!

**Lincoln Log Homes
6000 Lumber Lane
Kannapolis, NC 28081**

**If Your Grandfather
Didn't Leave You His...**



DELTA

**Free Ripfence
Free Worklight
\$93.50 Value**

For over 40 years now, the most popular bandsaw made. For toymaking to furniture making, whether you're re-sawing, cutting curves or ripping, a bandsaw gives you the most flexibility.

Sturdy cast iron components make this machine stable and smooth running. Height capacity is 6-1/4". Large 14" square table tilts 45 degrees right and 10 degrees left and is machined to accept standard Delta 3/8" x 3/4" miter gauge. Weighs 224 lbs. with motor and stand. The 28-858 flexible neck lamp uses standard appliance bulbs. The 28-845 ripfence package comes with 32" bars. Motor is 1/2 HP, ball bearing, 1725 RPM.

(Remember, we pay the freight.)
28-243 Delta 14" Bandsaw with Motor, Stand, FREE Worklight and Ripfence
List \$808.50/SALE \$599.00 delivered.

**Woodworker's
Supply**

(OF NEW MEXICO)

5604 Alameda, NE • Dept. WO
Albuquerque, NM 87113

Toll-Free: 1-800-645-9292

VISA/MC

DMT

**DIAMOND
WHETSTONE™**



The Diamond Whetstone™ sharpener will put a perfect cutting edge on valuable workshop tools. Sharpens even carbides easily. Clean — uses only water as a lubricant. X-coarse is excellent for dressing Japanese water stones. Satisfaction guaranteed.

For Kitchen, Shop and Sports

SEND FOR FREE BROCHURE



POCKET MODEL in Leather Case BENCH MODELS in Wooden Box

	\$19	\$39	\$64	\$95
	4.3"	6"	8"	12"
Fine				
Coarse				
X-Coarse				

Major
Credit Cards
Accepted

Add \$2 shipping & handling on all orders.

PARKER'S Box 241-W115
Wellesley Hills, MA 02181

**Bargain Corner for
Clock Builders**

**Quartz Movement
"Six Pack"**



Reg. \$5.95 ea.
SAVE \$15.75!

LOWEST PRICES EVER! Special savings on our versatile "Ultra-Thin" (only 5/8" thick) movement. Includes minute and hour hands.

#90201 for dials to 1/4" thk. #90202 for dials to 5/8" thk.

Order by the "Six Pack" — **ONLY \$19.95**
(Plus \$1.50 Shipping and Handling IL Res. Add 6.25% Tax)

Dial Numeral Assortment

Enough to build 30 clocks — **ONLY \$9.95**

**SAVE
60%**



A REAL PROFIT MAKER! Precision molded with brilliant gold finish. Permanent self-adhesive backs. #43700 Numeral Set (Purch. Sep. \$23) **ONLY \$9.95**
(Plus \$1.50 Shipping and Handling IL Res. Add 6.25% Tax)

100-PAGE CATALOG!

Clock Kits, Movements and Dials

SEND \$2.00
TODAY!

312-584-9600

VISA

Master-Card

Craft Products Co.

Dept. BG5N, 2200 Dean Street, St. Charles, IL 60174

**UNIQUE
WOODFINISHING
OFFER!**



**SEALACELL® 1 2 3
INTRODUCTORY KIT
JUST \$5.50 POSTPAID**

You'll be amazed at how easily these three simple steps will produce that professional hand-rubbed oil look. Wipes on, no brushes, no clean-up, no dust-free room needed.

The kit includes three 4 oz. containers: 1) Sealacell® sealer, 2) Varnowax® oil/wax base and 3) Royal Finish® satin finish - enough for your dining room table or chest of drawers.

Take advantage of this special offer now!

GENERAL FINISHES® P.O. Box 143632 Phone:
Milwaukee, WI 53214 (414) 774-1050

Please send Sealacell Kit and charge \$5.50 to my:

MC VISA Check Enclosed

Acct. No. _____

Exp. Date _____

Name _____

UPS Address _____

City _____ State _____ Zip _____

Quality Wood Finishes Since 1926



**Let's close the book
on forest fires.**

Ad Council

A Public Service of This Magazine
& The Advertising Council



BUYMANSHIP BASICS

Continued from page 61

EPOXY

ADVICE ABOUT CLEANUP: THINK FAST

Due to its quick cure time, epoxy drips and spills demand prompt attention. Protect your work surface with disposable plastic or newspaper, and have plenty of clean, absorbent toweling on hand for spills. Wipe up the contaminated work area or tools with a clean absorbent rag or paper towel.

If caught immediately, some epoxies will clean up with soap and warm water and lots of scrubbing. For any epoxy that remains, dampen clean rags or toweling with a solvent and wipe clean. Acetone, lacquer thinner, and denatured alcohol are good cleaning solvents, although many companies mix their own formulas. For larger spills, use a spatula to pick up the epoxy.

Contrary to popular belief, using a solvent for cleaning epoxy from your skin is actually more dangerous than helpful. The solvent dilutes the epoxy and drives it deeper into your skin; it also dries the natural oils in your skin. That's why your skin appears white and feels so dry after coming in contact with a solvent. We're not telling you to dismiss the use of solvents, we're just telling you to use them safely and only when necessary.

If you do get epoxy on your skin, a waterless hand-cleaner like those used by mechanics does a better and safer job than a solvent. In the workshop, we've sprinkled an ordinary household abrasive-cleaning powder on our hands after being a bit careless when applying an epoxy. Rubbing the epoxy with the cleanser and a little water forms "gum balls" which can be washed off. (It takes only a few scrubbing to realize that prevention is much easier than the cure!) Finish with a thorough washing in warm soapy water. When using a large amount of epoxy or covering a large area, apply a skin barrier cream above the glove line to prevent coming in contact with the epoxy.

STORING EPOXY: USE IT OR LOSE IT

Industrial Formulators of Canada, who formulate more than 100 different basic epoxy resins, advise you to keep the resin and hardener in tightly sealed containers. Otherwise, the hardener reacts with moisture and carbon dioxide in the air, causing it to lose its effectiveness when mixed with an epoxy resin. You also should store the hardener and resin in an area of constant temperature.

Gougeon Brothers of Bay City, Michigan, a leader in the use of epoxies in boat construction, recommends that you purchase only as much epoxy as you can use within 18 months (although Gougeon Brothers report having used properly stored epoxies five years later without significant loss of strength). They also recommend storing it in a dry area where the temperature is kept between 50 degrees and 90 degrees Fahrenheit.

If the hardener looks cloudy and lumpy instead of clear, it's probably contaminated. When stored at excessively cold temperatures, crystals may appear in the resin. To dissolve the crystals, heat water in a large pot to the boiling point, then remove the pot from the heat source. Remove the lid from the resin container (to avoid a pressure buildup), and place the opened container into the hot-water bath, being careful to keep the hot water out of the resin. Stir the warmed mixture until all the crystals have disappeared.

INFORMATION SOURCES

Write these manufacturers for literature and product list of epoxy and related products.

● **Gougeon Brothers Inc.**, 706 Martin St., Bay City, MI 48706.

● **Industrial Formulators of Canada LTD.**, 3824 William St., Burnaby, B.C., Canada V5C 3H9.

● **Chem Tech**, 4669 Lander Rd., Chagrin Falls, OH 44022. ■

EXCALIBUR 24 • EXCALIBUR II Make The Precision Decision

To Order Call Toll Free **1-800-387-9789**

EXCALIBUR 24" c/w ¼ Hp Var. Speed Motor & HD Stand



SHIPPED UPS
PREPAID
\$1295.
US
NO OTHER CHARGES

Excalibur 24's are working to exacting standards in industrial and commercial settings in schools and other institutions, and in the homes of dedicated hobbyists across the country.

Excalibur Precision Scroll Saws At-A-Glance

	Excalibur 24	Excalibur II
Throat	24"	19"
Cutting Depth Maximum	2 1/2"	2"
Length of Cutting Stroke	1 1/2"	1"
Cutting Speed	6-1800*	1400 Single-Speed 800 speed 400 motor*
		6-1800 variable speed motor*
Worktable adjustment Right	20"	45"
Left	45"	45"
Worktable Width	14"	12"
Worktable Depth	24"	17 1/2"
Overall Length	35"	37"
Overall Width	21"	12"
Overall Height	21"	11"
Weight	10 lbs	45 lbs

*Rpm (strokes/minute)

SHIPPED
FREIGHT COLLECT
\$495.
US
NO OTHER CHARGES

EXCALIBUR II Less Motor & Switch



The budget-respecting Excalibur II accepts any motor to become the true craftsman's dream with features unparalleled at its price.



SEND FOR OUR CATALOG
OF OTHER FINE
WOODWORKING MACHINES



J. Philip Humfrey International

3241 Kennedy Road, Unit 7
Department WM 11/12B
Scarborough, Ontario M1V 2J9 (416) 293-8624

I enclose \$1.00 (refundable against purchase).
Please rush my catalog.

Name _____

Address _____

City _____ State _____ Zip _____

TOOL CITY
BEATS ANY AD PRICE THIS ISSUE
FREIGHT PREPAID (USA)

MAKITA

ALL MAKITA TOOLS
 30-45% OFF • PHONE FOR PRICE

HITACHI

All Hitachi Tools
 30-45% OFF • PHONE FOR PRICE

MILWAUKEE

ALL MILWAUKEE POWER TOOLS
 25-40% OFF • PHONE FOR PRICE

PORTER CABLE

ALL PORTER CABLE POWER TOOLS
 25-45% OFF • PHONE FOR PRICE

BOSCH

ALL BOSCH POWER TOOLS
 25-45% OFF • PHONE FOR PRICE

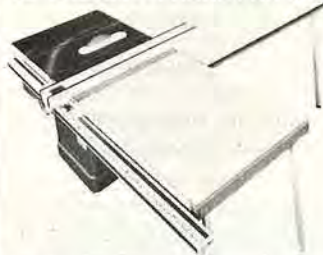

BIESEMEYER RIP FENCES

40" Home Shop \$199
 50" Commercial \$289

Call for other Biesemeyer Products

FREUD

SAW BLADE SPECIALS
 FREUD SAW BLADES 10" = 3/4"
 Bore Carbide Tipped 12" = 1" Bore

No.	size	teeth	use	list	sale
LU72m10	10"	40	general	\$ 68.58	\$ 34.50
LU73m10	10"	60	cut-off	79.65	35.00
LU73m12	12"	72	cut-off	113.35	76.00
LU78m10	10"	80	plastic	117.02	83.50
LU82m10	10"	60	cut-off	86.40	76.00
LU82m12	12"	72	cut-off	123.36	85.95
LU84m11	10"	50	comb	74.51	37.00
LU85m10	10"	80	cut-off	110.88	62.00
LM72m10	10"	24	ripping	68.58	35.00
DS306	6"		Dado	139.00	94.00
DS308	8"		Dado	179.00	107.00

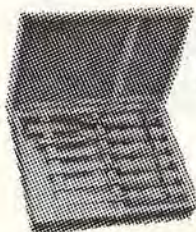

FREE
 WOODEN
 CASE

FREUD TOOL SETS

	REG.	SALE
4pc Chisel set	\$ 29	\$ 19
6pc Chisel set	39	29
10pc Chisel set	67	49
8pc turning set	68	49
6pc carving set	75	58
12pc carving set	139	109
Carvers mallet	10	8

ALL FREUD ROUTER BITS & SHAPER CUTTERS 25% OFF

TOOL CITY
 14136 E. FIRESTONE BLVD.
 SANTA FE SPRINGS, CA 90670

Open Monday-Saturday 8:00 am-5:30 pm

WE SHIP IT FAST!

OUTSIDE CA 1-800-423-7899
 INSIDE CA 1-213-802-1236

or personal check



HITACHI PLUNGE
 ROUTER SALE
 Both come with
 \$60 worth of
 accessories

HP	MDL#	List	Sale
1	TR8	\$206	\$119
3	TR12	\$299	\$169

DOWL-IT doweling jigs

standard
 #1000
SALE
 \$25

Improved
 #2000
SALE
 \$35

FREE WITH ANY ORDER
 #1 PREPAID FREIGHT
 #2 2-YR SUBSCRIPTION
 TO TOOL CITY CATALOG
 #3 USA MADE HEX KEY SET



ERMACO Nail-Gun
 Compressor, 1 hp., \$289
 145 PSI, 4.5 CFM 2.5 gallon
 tank. Only weighs 52 LBS.

SENCO

CALL FOR BEST PRICES
 ON SENCO
 FASTENING PRODUCTS



FREUD 15-piece router bit set.
 Complete with wooden case,
 retail price is well over \$300.
 On SALE now \$139.

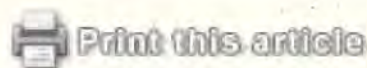

**THE CHRISTMAS
 WAGON**

When the mailman delivered this heartwarming remembrance from Leon Powell of Memphis, Tennessee, we decided to share it with all our woodworking friends in this holiday issue.



In thinking back I suppose the Christmas wagon was built simply because my father had the skill to do it. He was one of those carpenters who, a generation ago, could perform all the operations needed to build a house. True, there were generally two or three assistants to help with the rough carpentry and to hold boards for nailing. Working totally with hand tools, these all-around craftsmen did whatever task had to be done.

These same skills kept our house in repair as well as various farm implements and tools used to keep a country place going. It was only natural then, during the Great Depression, that such craftsmanship be used to provide some Christmas joy.

"Building a wagon could not be kept secret, so we watched, my two brothers and I, as the project took shape."

Building a wagon could not be kept secret, so we watched, my two brothers and I, as the project took shape. In memory the wagon seems to have been about one-third the size of a standard farm wagon, but it was in a class by itself.

The axles were shaped from seasoned hickory timbers which my father kept on hand for tool handles and such. I can remember him using the handsaw, drawknife, plane, and brace and bit. There was no sanding, yet the wagon parts seemed smooth as glass to youngsters who had yet to handle tools without difficulty. We were awed at the ease with which the wood was shaped, how the oak and gum bed fit together, how the arched top of the front axle served as a fifth wheel beneath the bolster.

Continued on page 80

WOODWORKERS

FULL SIZE PATTERNS

Simple to make - Fun - Profitable

- 75 pattern packet plus "Shop Secrets"
- Over 50 "Folk Art" patterns
- 6 "Wind-Action" whirligigs packet
- 40 craft plaques plus projects
- 8 child pleasing aircraft packet
- 6 decorative magazine racks

Send \$6.00 per blueprint packet or choose any 3 FOR ONLY \$12.00.

ACCENTS, Dept. MA115
P.O. Box 262
Danvers, MA 01923



Brochure of 400 designs \$2.00
(Free with order)

LIVE STEAM TRACTORS

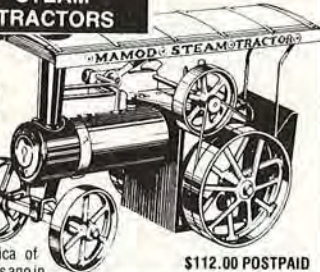

Working Replica of ones used years ago in Lumber Camps and Threshing Runs. Comes complete with Brass Boilers, Copper Steam pipes, Steel fire box, cylinders, pistons and whistle that actually blows, made of brass. Uses water and burns solid fuel. Takes 3 to 5 minutes to raise steam, then will go 1/3 of a mile, self-propelled. Develops 1/15 hp., 3000 rpm., 10" long, 7" high, 5" wide, weight 4 1/2 lbs. Made in England. A real work of art, gleaming and beautiful. \$112.00 Postpaid. Order Toll Free 1-800-821-5157.

\$112.00 POSTPAID

BLUE STAR, DEPT T25
Box 3042, Rosedale, Kansas 66103

WOODWORKERS

Save on Wood - Tools - Supplies!

OVER 4000 ITEMS

Send for New 1986 148 Page Money Saving CATALOG

OUR 56th Year

Dept. K115, 1735 W. Cortland Ct., Addison, IL 60101
Please enclose \$1.00 to help pay postage and handling

Finest Dimensioned HARDWOODS and Quality VENEERS

42 Varieties 1/64" to 4" Thickness
Fast service on choice kiln dried Wood and Veneers, Moldings, Trim, Hand and Power Tools, Lamp Parts, Upholstery Supplies, Clock Movements and Kits, Hard-to-Find Hardware, Finishing Materials, Books... over 4000 items in stock! Craftsman—Woodworker's best friend.

\$3.00 Discount Coupon good on first order.
FREE with Catalog!

CRFTSMAN WOOD SERVICE

SEND \$1.00 FOR A CATALOG

- Plans
- Patterns
- Ideas



Craftplans

21801 Industrial Boulevard,
Dept. CR4
Rogers, Minnesota, 55374-9514

HARDWOODS DOMESTIC AND IMPORTED

Veneers

Boat Lumber • Cabinet Lumber

Red Oak • White Oak • Ash • Birch • Birdseye • Teak
Mahoganies • Cherry • Walnut • Maple • Poplar • Basswood
• Bubinga • Pearwood • Osage • Pines • Padouk • Ramin • Rosewood
Wenge • Zebrawood • Bocote • Cocobolo • Che Chen • Ziricote
Oak Mouldings • Dowels • Hardwood Plywoods
Planing • Rippling • Millwork

No Minimum • Shipments Worldwide
30 Yr. Member National Hardwood Lumber Assoc.
Direct Importers of Foreign Hardwoods



United States Mahogany Corp.
746 Lloyd Road, Matawan, NJ 07747
(201) 583-6300

Open Monday thru Saturday

JWC*

*The JAPAN WOODWORKER'S Catalog is loaded with the best tools you can get your hands on. Unlike other suppliers, at the Japan Woodworker, Japanese woodworking tools are not a sideline. We are the original supplier of these tools to the Western woodworker. In our catalog you will find a complete selection of Japanese tools for the woodcarver, carpenter, and cabinetmaker. For those of you who want the finest tools money can buy, our "Tools as Art" section will be of particular interest. Send \$1.50 for our catalog and supplements during the next two years.



THE JAPAN WOODWORKER 1731 Clement Ave., Alameda, CA 94501 / Phone (415)521-1810



FREE Tool Catalog

Quality Products For Woodworkers

Send today for your FREE copy of our new colorful catalog. It's fully illustrated with the finest quality tools, supplies, books, components, hardware, and much more. Satisfaction Guaranteed.
Write today for your FREE catalog.



WOODCRAFT SUPPLY CORP.
Dept. WBH115
41 Atlantic Avenue, Box 4000
Woburn, Massachusetts 01888

DEALER ENQUIRIES INVITED

SHOPSMITH OWNERS



LATHE DUPLICATOR

DRUM SANDER



DOWELING ATTACHMENT

Clamps for all your woodworking needs

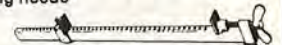

UNIVERSAL CLAMP CORPORATION

6905 Cedros Ave. • Van Nuys, Calif. 91405

PROTECTIVE TOOL ROLL

\$10⁵⁰

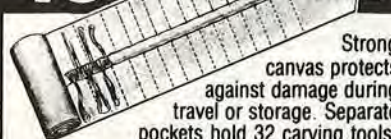

Strong canvas protects against damage during travel or storage. Separate pockets hold 32 carving tools, mallet and sharpening stones.

+\$2 Postge.
Liberal discount to Schools and Dealers.
FREE 32-P. German steel tool catalog-write:
FRANK MITTERMEIER, INC.
IMPORTERS OF FINE TOOLS SINCE 1934
Dept. WM-115, 3577 E. Tremont Avenue
Bronx, New York 10465

Three New Plans Buy 1 Get 2 Free

Child's Double Easel

Adjusts to 4 Heights



Send \$9 for these Child's Double Easel plans, and receive FREE full size plans for a Doll Cradle, and FREE plans for a Toy Box/Boot Bench.

A DAY'S WORK Dept. HG
R.R. 6, Box 114A Iowa City, IA 52240

When you order my 16-piece Forstner Bit Set at \$149⁹⁵



It's like getting the 7-piece set plus the 1 1/8" and 2 1/8" bits -

FREE!*

Only a Forstner Bit could drill all these arcs at all these angles and make perfectly clean flat bottomed holes even through knots, end grains, and veneer!

*Just buying the 7 sizes from 1 1/4" to 2" at their individual prices, you'd spend \$151.15.

But saving money isn't the real reason you should invest in these bits. Superior performance is.

A clean, smooth, flat bottom hole is essential for strong dowel joints. And my Forstner bits make an absolutely clean hole, with only a tiny notch in the center of the perfectly flat bottom. That makes them the bits of choice for furniture making, for starting rabbets or grooves, for making pocket holes to attach rails to table tops.

And because the outer rim, not the center spur, guides the bit, you can use your Forstners to drill any arc of a circle, at any angle - even through knots, irregular grain, or veneer. The 3/8" shanks fit your drill press or 3/8" and 1/2" portable drills.

Order the 7-Piece Set for just \$49.95 and receive all sizes, 1/4" through 1", plus the FREE Storage Carousel.



FREE CAROUSEL
with any set

FREE DIAMOND HONE
with 16-Piece Set

For greatest value, take the 16-Piece Set for \$149.95. You receive all 16 bits plus the FREE Carousel and FREE Diamond Hone to keep all your Forstner Bits sharpened to the peak of performance.

30-Day Money Back Guarantee

ORDER NOW—WHILE SUPPLIES LAST!



The Fine Tool Shops, Inc.
Dept. WMD5
20 Backus Avenue,
Box 1262
Danbury, CT 06810

ORDER TOLL FREE
1-800-243-1037
In CT, 797-0772



Ship to _____
Address _____
City _____ State _____ Zip _____

Qty.	Item	Prod. #	Price ea.	Total
	7-Pc. Forstner Bit Set with FREE Carousel	200-2537	\$ 49.95	
	16-Pc. Forstner Bit Set with FREE Carousel, Hone	200-2587	\$149.95	
	Carousel only	200-2580	\$ 12.95	
	Hone only	500-1115	\$ 9.95	

- Send **FREE** Full Color Tool Catalog
- Check Enclosed
- Charge my
- VISA MasterCard
- AmExpress

Subtotal		
Shipping/Handling		\$3.00
CT 7 1/2% Sales Tax		
TOTAL enclosed		

Account # _____ Exp. Date _____

THE CHRISTMAS WAGON

Continued from page 78

All this work started in late fall when other chores were done. My father, by this time, was out of house-building because few persons in our area had money to build houses. Money from remodeling jobs was supplemented by family farming. So when the harvest was over, the wagon building started. The axles, bed, frame, and other parts of the wagon were completed in a few weeks. Next came the wheels.

Knowing the characteristics of local woods, my father selected a black gum tree for wheel material. This tree, a member of the dogwood family, is difficult to split. We watched my father fell the tree with a one-man crosscut saw. He then cut log sections about 3" thick from a point where the tree was about 15" in diameter.

After center-boring the wheels, the holes were enlarged to fit over the axle ends, which had been rounded about 3 1/2" from a square shoulder. At this point my father took four tin cans saved for the purpose and fitted them over the axles, retaining each with a nail driven into the end of the axle. Axle grease was applied, the wheels fitted, and finally dowels were driven through the axle to hold the wheels on.

By Christmas the wagon was ready. We were delighted, and the wagon was used almost daily for coasting downhill, hauling milk cans, wood, whatever struck our fancy. It was, in fact, the only toy we got for Christmas that year. We used the wagon for a few years, replaced the wheels, and used it some more. When our interest faded, the old wagon was relegated to a barn shed.

In the years that followed, I grew up, went to war, later married, and bought shiny, red wagons for my own children. Yet now, 50 years after the wooden wagon was built for three boys at Christmas, it appears in memory like the masterpiece I truly believe it was. ■

EDLCO

Appalachian Hardwood Specialists
Now Serving Craftsmen
Select from over 21 species
Imported And Domestic Hardwoods
Softwoods

Veneers Shorts Turnings
Kiln Dried Delivered Prices
New Catalogue \$2.00

Write today EDLCO

Box 5373 W

Asheville, N.C. 28813

Phone (704) 255-8765

Stay In The Woods With Us

EDUCATIONAL LUMBER CO., INC

SUPER SCOOPER



KIDS WILL SPEND HOURS OF FUN IN THE SANDPILE WITH THIS CHILD OPERATED BACKHOE • Works like a real backhoe • 3 foot reach • Swings in a full circle on ballbearing • Develops child coordination and motor skills

Easy to follow plans..... \$ 4.00
16 gauge welded steel bucket..... \$ 10.50
Heavy-duty swivel bearing..... \$ 10.50
Complete unit..... \$165.00

Send check or money order to:

BALLART DESIGN 4606 So. 600 East, #709
Salt Lake City, Utah 84107



Clamp odd shapes together with adjustable tension, reusable parts. Professional results at home prices using MITY-TITE components. For: cartons, beehives, storage, furniture, framing, gluing, car-tops, shipping, woodworking, cabinetry.

Kit includes: 150 ft. of strapping, 20 plastic and metal buckles, plus tension tool. Fully guaranteed.

Send to-MITY-TITE 4229 1st NW, Seattle WA 98107

Name _____ only \$14.95

Address _____ + \$1.70 FREIGHT & HANDLING

City _____ State _____ Zip _____ WASH. RESIDENTS ADD 7.5% TAX

101 GIFT & NOVELTY PATTERNS

This wonderful packet contains 101 FULL SIZE PATTERNS of Gifts, Novelties, Lawn Figures, Bird Houses, Shelves, Action Windmills, Alphabets, and many more things. Just trace and saw out. Plus "Make Money Jig Sawing". Only \$7.00 Prepaid 1st Class for this big packet.



MASTERCRAFT PLANS WEST, DEPT. 115
P.O. Box 625, Redmond, WA 98073

90 PATTERNS LAWN ORNAMENTS NOVELTIES

FULL SIZE patterns up to 20" high of Dutch boy and Girl, Dwarf, Penguin, Fishing Boy, Animals, Birds, Novelties and many other popular items. Easy to make and sell. Just trace, cut out and paint. Send \$7 today for the LAWN ORNAMENT PACKET containing all 90 patterns. Prepaid, 1st Class.



MASTERCRAFT PLANS WEST, Dept. 112
PO Box 625, Redmond, WA 98073

22 1/2° OCTAGON GAUGE



TO SET MITER TO SAW BLADE FOR 22 1/2° CUT. HARDENED ALUMINUM GAUGE HAS OCTAGON FORMULAS AND 14" RULER SCREENED ON. ALSO SCREW CHECKER AND INFORMATION.

\$7.95

Plus \$2.00 Handling and Shipping

California residents add 6% sales tax. Send check or money order to:

LYON ELECTRIC COMPANY, INC.
P.O. BOX 81303 SAN DIEGO, CA 92138

WOOD TOY

- ★ Patterns
- ★ Parts
- ★ Wheels
- ★ Many New Patterns to Choose from.
- ★ Free Shipping in U.S.A.

SEND \$1.00 FOR NEW CATALOG AND RECEIVE COUPON FOR FREE WHEELS & AXLE PEGS.



toys and joys

Box 628W Lynden, Wash. 98264

35 Years in Creative Arts & Trades

Van Dyke's

Presents a Supply Catalog for Upholstery, Antique Restoration, Wood Working & Related Trades!



Many Hard-to-Find Items!

SEND FOR YOUR FREE CATALOG:

Van Dyke's Supply Co., Dept. 55
4th AVE., WOODSOCKET, SOUTH DAKOTA 57385



LOOKING AT YESTERYEAR

This 1" scale miniature wagon is an ideal project for the craftsman with an eye for beauty and charm of Early America. You can easily build this miniature using our full size cutting patterns and details.

\$6 + \$1 handling. Catalog: \$1.
Criss-Cross, Box 324BJ, Wayne, NJ 07470

SHOPSMITH® OWNERS

Make raised panels using our 3 wing carbide tipped shaper cutters.



M75 Shaper Cutter (4 1/2" dia.)
List \$138
Sale \$99
M76 Auxiliary table-\$30
M78 Arbor-\$22
(Plan only \$8)

All prices post-paid to 48 states
Send check, MO: VISA, MC accepted
(C.O.D. - add \$3)

MANNY'S WOODWORKER'S PLACE

602 S. Broadway

Toll Free Lexington, KY 40508 In Kentucky
1-800-243-0713 (606) 255-5444

WOODCRAFT



FREE Tool Catalog

Quality Products For Woodworkers

Send today for your FREE copy of our new colorful catalog. It's fully illustrated with the finest quality tools, supplies, books, components, hardware, and much more. Satisfaction Guaranteed.

Write today for your FREE catalog.



WOODCRAFT SUPPLY CORP.
Dept. WBH115
41 Atlantic Avenue, Box 4000
Woburn, Massachusetts 01888

BUILD IT YOURSELF

TOYS • PUZZLES • PLAQUES • PLANTERS
FURNITURE • LAWN ITEMS • BIRD HOUSES
ROCKING & RIDING HORSES • PLAY SETS



BLUEPRINTS

CREATE HUNDREDS OF ITEMS ILLUSTRATED
WITH SAME SIZE PATTERNS CATALOG #1
PLUS WHEELS AND BOOKS

Design Group, Box 514-Z, Miller Place, N.Y. 11764



Develop a profitable second income in your spare time making small, unique bandsaw boxes. This unpublicized, little-known technique allows you to turn common inexpensive lumber and scraps into valuable utility boxes for the home and office. High demand in gift shops, stationery stores and craft fairs. Fully illustrated instruction booklet of 15 original and profitable designs. Satisfaction absolutely guaranteed. Send \$10.00 to **Box-Art, Dept. P, Box 8069, Woodridge, IL 60517.**

If you like to build things, NRI can show you how to make money building homes.

Learn professional contracting techniques at home in your spare time with NRI's new Building Construction Course.

Within the next 10 years, this country will need 18 million new homes... and the contractors to build them. Right now, there's heavy demand for remodeling and renovation experts. And NRI can get you ready... teach you everything you need to know, get you ready for management and supervisory jobs, even your own business.

Learn to Read Plans, Estimate Costs

We start you right at the beginning, with key lessons on site selection and planning. Then, you learn to lay out a home, read blueprints, and estimate costs accurately. Working with a complete set of plans for an NRI energy-efficient home, you get experience in every stage of construction.

Learn Professional Secrets

You're trained to work with all the trades. You learn the basics of carpentry, masonry work, electricity, plumbing and heating, and more. And because you know what it takes to do the job, you know what to look for when supervising and inspecting.

Training Built Around Energy-Efficient Home

You learn better because NRI training is practical training. You get over 100 action projects from



scale-model construction to building actual framing sections. Lessons and projects are coordinated with a contemporary energy-efficient home designed especially for NRI. You keep these plans to build your own home or select from more than 50 low-cost optional plans.

Includes Regional Seminar

As an exclusive service, graduates may participate in optional owner/builder seminar. You'll get expert advice on local building codes and conditions, meet builders, learn more about energy efficiency, receive tips on financing. There'll be demonstrations, insider info on remodeling, hands-on programs to take part in.

Send for Free Full-Color Catalog

Get all the facts on this big new opportunity. Send the coupon for your free copy of NRI's Building Construction Catalog. Now is the time to build a future for yourself! If coupon has been removed, write to NRI Schools, 3939 Wisconsin Avenue, Washington, D.C. 20016-9973.

Circuiting for safety

GUIDELINES FOR SHOP WIRING

Outdated or inadequate wiring makes working in your shop inconvenient, frustrating, and dangerous. Follow these pointers for safety and productivity when you upgrade.

M Print this article

Many older, unremodeled homes suffer from too little electrical capacity. Prior to 1960, most homes were equipped with 60-amp service panels. But that was before all the electrical conveniences we enjoy today. If a check of your service panel reveals 60-amp service, don't attempt to run more wires from it to power your shop. You'll simply be compounding a bad situation. What you need is greater capacity—and unless you're qualified to install a larger panel, call a licensed electrician for advice.

Newer and many remodeled homes have been updated with 100-amp or larger service panels. These homes will normally have a few unused circuits that you can utilize. Even with panels that appear to be already in service, you can sometimes split an existing circuit or two to satisfy minimal electrical requirements.

Sometimes, though, you must add a subpanel in order to supply a larger shop or one that's a good distance from the service panel. And if you have (or plan to have) several large stationary power tools, you should go the subpanel route. If you're unsure, again contact a licensed electrician.

How much lighting do you need?

A circuit combining lights and outlets for power tools risks a blackout when overloaded. Avoid

Continued on page 85

NRI SCHOOLS

McGraw-Hill Continuing Education Center
3939 Wisconsin Avenue
Washington, DC 20016



Please rush me the one free catalog I have checked. I understand there is no obligation.

For Career courses approved under GI bill check for details.

- Building Construction
- Air Conditioning, Refrigeration, Heating and Solar Technology Courses
- Small Engine Repair Course
- Appliance Servicing Course
- Locksmithing Course
- Automotive Mechanics Course
- Telephone Servicing Course
- Industrial Electronics
- TV/Audio/Video Servicing, Communications, Electronics, Microcomputers, Electronic Design Technology, Electronics Courses

WE'LL GIVE YOU TOMORROW.

Name _____ (Please print) Age _____

Address _____

City/State/Zip _____

Accredited by the National Home Study Council

1335-115

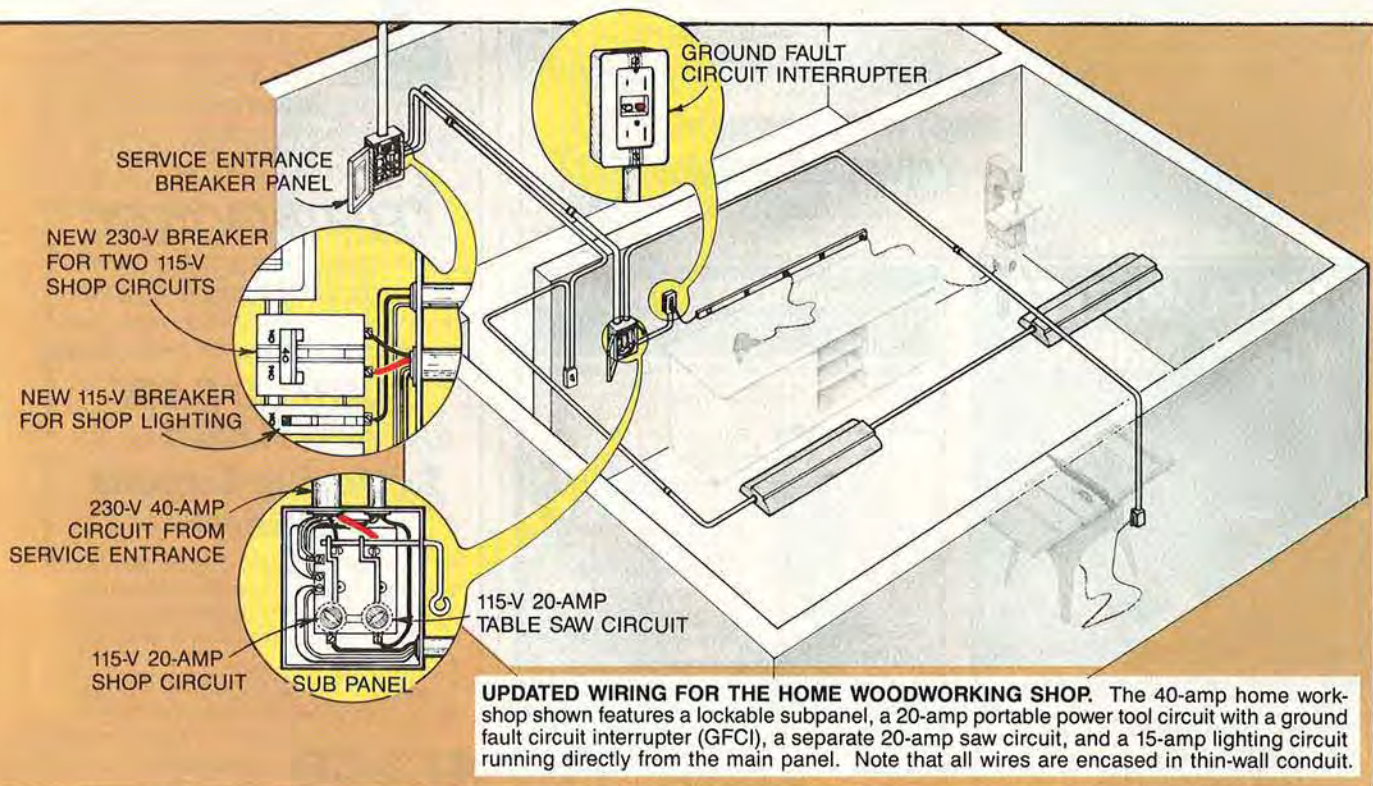

NEW! Woodmaster Variable Speed Power-Feed

PLANER/MOLDER JOINTER/SANDER



FREE 30-DAY TRIAL!

SAVES YOU MONEY! Put this versatile power-feed tool to work in your own shop. See how fast it **pays for itself!** Quickly converts low-cost rough lumber into valuable finished stock. Turns out perfect quarter-round, casing, base mold, tongue & groove ... all popular patterns ... any custom design. Joints super-true edges, squared stock, bevels and chamfers.

MAKES YOU MONEY! Now you can start your own high-profit business selling all types of millwork to lumberyards, carpenters, contractors, picture framers, do-it-yourselfers. Use it to make grandfather clocks, gun cabinets, furniture, toys, planters, porch swings, benches, paneling, flooring. In fact, this one power-feed tool opens up a truly astonishing range of products you can make and sell.



Jointer lets you move back to planing without changeover.



Produces tongue & groove with one set-up, two boards in same pass.



Turns out high-value, satin-smooth custom moldings plus all popular patterns.



Optional sanding head converts planer to power-feed drum sander!

FREE INFORMATION KIT



New Sanding Attachment
Quickly converts machine to one of the finest drum sanders available. Consistent power feed eliminates "low spots" and irregularities caused by hand sanding method.

Revolutionary Quick-Change Molding Head!
Exclusive patented design lets you mold up to six patterns in a single pass! Eliminates time-consuming set-ups. Uses low-cost cutterbits. Makes it easy to produce patterns impossible to duplicate on any other planer.

WOODMASTER TOOLS, INC., DEPT. PW9
2908 OAK • KANSAS CITY, MO 64108
Or Phone 1-800-824-7888 Oper. 642

YES! Please rush me your **FREE Information Kit** plus details on your **30-DAY FREE TRIAL GUARANTEE!**

NAME _____
ADDRESS _____
CITY _____
STATE _____ ZIP _____

SIGN CARVING IS PROFITABLE!



And it's easy, if you use the Marlin Woodcarvers and accessories. You can carve signs quickly at home or at swap meets. The machines do the work, the operator has the fun and profits.
No Special Training Is Required!

SEND \$1.00 FOR OUR BROCHURE AND PRICE LIST, AND BEGIN TO PLAN YOUR FULL OR PART-TIME BUSINESS.

Fine Carving Machines Since 1971

MARLIN INDUSTRIES

1911 OBISPO AVE., DEPT. D512
LONG BEACH, CA 90804
(213) 498-0767



Wood Ship Models



Build a handsome model worthy of your time and care.

Our scale model wooden ship kits contain only the finest materials for plank-on-frame and solid hull construction. Send \$2 (refundable with purchase) for illustrated catalog of kits, fittings and supplies.



BLUEJACKET SHIP CRAFTERS

ESTABLISHED 1905

P.O. Box 533 - BH, Shelton, CT 06484

WHEEL-RIGHT Wheel Maker

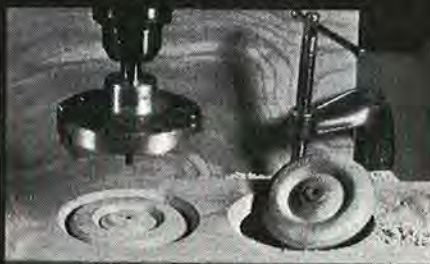

Never before possible a professional wheel maker that allows you to quickly mass produce detailed quality wooden wheels at a low low cost. Also turn out Rosettes and YoYo's.
\$59.95 plus \$2.00 shipping and handling

The Tool Company

1306-G South Commercial
P.O. Box 629, Dept. BHG-6
Harrisonville, MO 64701
(816) 884-2679

Mo. Res. add 5.625% Sales Tax

Sleeveless DRUM SANDER

NO PRE-MADE SLEEVES TO BUY

ECONOMICAL — Simply cut sandpaper from standard size sheets
UNIQUE — Twist of key tightens sandpaper to drum.
SPONGE RUBBER backing insures long wear of sandpaper



1" x 3" long \$13.50
2" x 3" long \$15.50
2 1/2" x 3" long \$16.00
3" x 3" long \$17.50
1" and 2 1/2" Above \$27.00
Above 4 Drums \$55.00

3/4" x 3" long \$14.50
2 1/2" x 4 1/2" long \$21.00
3" x 4 1/2" long \$22.50
2 1/2" x 6" long \$25.50
3" x 6" long \$27.50
Add \$2.50 Per Order For Shipping

AVAILABLE WITH:

1/2" Bore with 1/2" or 1/4" shaft
1/2-20 FH Thread except 1/2" x 3"
3/4" Bore except 3/4" x 3" and 2" x 3"

USE ON:

Drill Press
Small Motor
Lathe, Combo-Tools,
Radial Saw, 1/4" Drill



Send Check or Money Order to:

SINGLEY SPECIALTY CO. INC.

P.O. BOX 50876, GREENSBORO, N.C. 27403
CALL: (919) 852-9581

SCROLL SAW OWNERS - Lettering Layout Guides!

- Use our specially designed guides to layout letters & numbers to be cut from wood or other materials.
- Made from a durable plastic material.
- Several styles & sizes.

Send \$3.00 (Refundable with first order) for descriptive brochure & prices to:

SEYCO SALES

1238 Bardfield
Box 472749
Garland, Texas 75047

Wood Moisture Meter

- Avoid Moisture Problems
- Protect your Masterpiece

MINI LIGNO

Incl. Case, Batteries and Pins for 3/16" and 1/8" Measuring Depth.

only **\$110**

also from Lignomat:
MINI-LIGNO E
Range: 6%

Easy-to-use, sturdy instruments for the professional woodworker or serious hobbyist. Great for lumber, veneer, fiberboards. Ask for free catalog on the complete line of moisture meters and accessories for kiln drying.

Lignomat USA Ltd.

503-257-8957 800-227-2105

P.O. Box 30145h
Portland, OR 97230



WOOD REPAIR

Durham's Rock Hard Water Putty makes lasting repairs in wood. Won't shrink or fall out. Sets quickly, holds tight and can easily be painted. Economical, easy to use. Available at lumber, paint and hardware stores.

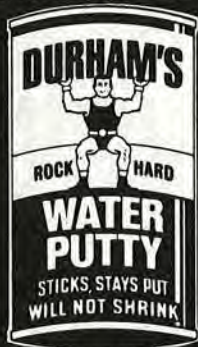

DONALD DURHAM COMPANY

Box 804-W Des Moines, IA 50304

IN ILLINOIS

1719 Chestnut Ave. 3218 Wireton Rd.
Glennview, IL 60025 Blue Island, IL
(312) 729-9663 (312) 389-7667

IN ARIZONA

1705 W. University
Tempe, AZ 85281
(602) 966-2444

Hardwood Mouldings

INCA Power Tools

Books & Magazines

Hand Tools

Watco Stains & Finishes

Freud

Router Bits & Sawblades

WOOD WORLD

DOMESTIC & EXOTIC HARDWOODS HARDWOOD PLYWOOD—VENEERS

You Select Your Own Lumber ■ Custom Cutting & Milling

WOODWORKING & CARVING CLASSES

WOODWORKERS AMATEUR & PROFESSIONAL

BAND SAW BLADES

WELDED TO YOUR EXACT LENGTH

WIDTHS	TEETH	PRICE/INCH
1/16"	24 & 32	\$0.9
1/8" thru 5/8"	3 thru 32	\$.05

OTHER SIZES AVAILABLE — INQUIRE
To Figure Price:

Inch Length x Price/Inch + \$1.85 Weld Charge
MINIMUM ORDER: \$40.00

Add \$2.50 for Shipping-Prompt Delivery

PHONE ORDERS —

1 (800) 543-8664 (Outside Ohio)

1 (513) 621-2159 (In Ohio)

VISA or MasterCard Accepted or

Send Payment with Order or

Write for More Information to:

BUCKEYE SAW COMPANY

P.O. Box 14794

Cincinnati, Ohio 45214

SHOP SAFETY

Circuiting for safety

Continued from page 83

no-light hazards by providing a circuit strictly for illumination. For general shop lighting, this means combinations of 4' or 8' 80-watt fluorescent fixtures (use cool-white tubes for brighter light). If you prefer working under incandescent light, use 150-watt fixtures. Task lighting at work stations—such as the drill press, stationary sander, and radial arm saw—requires additional 60-watt bulbs.

A 15-amp circuit will probably do the entire lighting job, but here's how to calculate if you're in doubt: (1) add up all the wattages (bulbs and fluorescents) you have or want; (2) divide that number by the circuit voltage (typically 115 volt in actual performance, rather than 110) to arrive at (3) the number of amps drawn if all fixtures were on. With a 15-amp circuit you wouldn't want to exceed 12 amps, since it's a wise practice to use only 80 percent of a circuit's capacity. This leaves 20 percent for unexpected over-usage which could lead to a blackout if you had figured full capacity.

Assessing your power tool wiring requirements

The number and type of power tools you use (or want to add) determine how many (and what size) circuits you should have. One 20-amp circuit may be all you'll need if you only use small power tools such as routers, drills, circular saws, and jigsaws (these tools normally draw 12 or so amps).

Stationary electric machines, such as a radial arm or table saw, however, have a much higher amperage rating than portable power tools and require one separate 20-amp circuit each. The reason for this singular attention is the increased power draw that stationary tools develop on startup. On a smaller capacity 15-amp circuit, tripped circuit breakers or blown fuses would be normal.

Continued on page 87

\$12 AN HOUR
YOU CAN EARN UP TO THAT AMOUNT

Start Your Own Business!
Earn Extra Income Right At Home.



Sharpen Saws...

...ALL Garden and shop tools for home and industry

Get In On The Profits!

Yes there's plenty of business waiting for the man who can professionally sharpen saws and all types of edge-cutting tools. SHARP-All does them all, and at big profit for you. No inventory is involved... no selling. You earn a year-round Cash income and make 90¢ profit out of every dollar you take in. Work sparetime hours or fulltime right at home, and no experience is needed.

Send TODAY for details of our 30-Day FREE Trial Offer!

With SHARP-ALL It's Easy To Get Started!

You don't need to invest thousands of dollars to get started in business for yourself. Low cost Sharp-All and our 50 years of experience in helping sincere men to earn extra income, plus the desire to get ahead is all you need. Complete Operators Manual gives clear, step-by-step instructions, shows exactly how to sharpen each tool, where to get the "tricks of the trade". And Sharp-All does the kind of precision job that brings customers back time after time.

There are NO franchise fees of any kind. With Sharp-All YOU are the boss... YOU set the hours you want to work... you put the profits in YOUR pocket.

FREE BOOKLET!
Send for your copy today. No obligation.

LIFETIME SECURITY
with YOUR OWN BUSINESS

If coupon has been removed, just send us a postcard with your name and address to—



FOLEY-BELSAW CO.
60527 FIELD BLDG.
KANSAS CITY, MO 64111

There is NO OBLIGATION and NO SALESMAN Will Call!



FOLEY-BELSAW CO.
60527 FIELD BLDG.
KANSAS CITY, MO 64111

YES, please send me the FREE booklet "Lifetime Security" and full details on your 30-Day Free Trial Offer. I understand there is No Obligation and that No Salesman will call on me.

RUSH COUPON TODAY!

FREE BOOK

NAME _____

ADDRESS _____

CITY/STATE _____

ZIP _____

QUARTZ CLOCK MOVEMENT

An Incredible Special Offer on Our Original Mini-Quartz

\$2.00

Additional Quantities—
No Limit—\$2.99 each

Here's quartz accuracy made in America...at a price that makes the savings incredible! Order your first movement for \$2.00 (Shipping and handling included)—save \$5.25 off the regular price! Additional quantities are just \$2.99 each, plus only 10% for shipping and handling. They're factory-new and guaranteed for 3 years! You'll also get a FREE PAIR of brass hands with every movement (call our toll free number for style of hands available on larger quantities), plus our Color Catalog and "Clockmaking Ideas" pamphlet. Order by mail or telephone. But don't delay...we must have your order postmarked or phoned in by December 30, 1985. Sorry, no foreign or C.O.D. orders. We reserve the right to terminate offer earlier if supply is depleted.

KLOCKIT

Limited Offer ... Call or Write Today!

Dept. WD115
P.O. Box 629
Lake Geneva, WI 53147

Call Toll Free
1-800-KLOCKIT
(556-2548)



Name _____

Address _____

City, State, Zip _____

Credit Card No. _____ Exp. Date _____

FREE 100's OF PARTS!
WORKSHOP ORGANIZERS

FREE \$18.95 hardwood parts ORGANIZER with purchase of our woodworking or toy-making parts selections. Parts are priced below our catalog prices. Send \$47.95 ppd. for either woodworking or toymaking parts (please specify) and receive \$18.95 organizer FREE! Visa & M/C. Color catalog \$1. (614) 484-4363

Cherry Tree Toys, Box 369-409, Belmont, OH 43718

MAKE TOYS & WOOD PROJECTS

7 CAR TRAIN
 \$6—Plan only.
 \$27.50—Plan & turned parts (92 parts in all!)
 Visa & M/C

62" long

100's of plans, kits, colored & unfinished hardwood parts for toys, crafts & furniture; plus tools, wood, finishes & supplies. Bulk prices available. Color catalog subscription \$1. (614)484-4363

Cherry Tree Toys, Box 369-9, Belmont, OH 43718

PADOUK - BUBINGA - SHEDUA - WENGE - ADD THAT EXOTIC FLAIR TO YOUR NEXT PROJECT!

We offer the best wood, prices and service available—it's as simple as that. Call or write for our catalog, \$1.00—refundable.

"The finest from around the world"
 P.O. Box 506
 Ellettsville, Indiana 47429
 (812) 334-7735

PURPLEHEART - DOUSSIE - RED OAK - CHERRY
 GONCALVALVES - PALDAO - WHITE OAK - ZEBRA

WOODWORKING'S HOTTEST BOOK!!

Special Holiday Offer!!
 Brand New Edition
Making Woodwork Aids & Devices
 Reg. Price \$10.95 ppd.
SALE Price \$8.95 ppd.
 (or we'll match any ppd. price this issue)
GET THE FROG®
 CATALOG FREE

Mail your check, M.O. or charge card info to:
FROG TOOL CO. LTD. Dept. WM-1
 P.O. BOX 8325 Chicago, IL 60680
 Visit our showroom at
 700 W. Jackson Blvd. (Chicago)
 VISA-MASTERCARD orders—
 Call (312) 648-1270

New
E-Z PNEUMATIC DRUM SANDER
 ...For woodworkers & carvers. Inflates to desired firmness, contours to the shape of your work. Eliminates hand-sanding. **Freedom tools-Detail Master burning unit-Abrasives-Books and more, at great prices!**
 Catalog \$2.00 (refundable).
North West Carving Supplies
 P.O. Box 5211
 Bozeman, MT 59715

BRANDING IRON
 For hard and soft wood

\$27.00
 Plus \$2.00 for shipping and handling
 Neb. residents add correct sales tax

HAND CRAFTED BY YOUR NAME HERE

GUARANTEED

- Shipped in 1 week
- Solid brass head
- First Line: HAND CRAFTED BY — as above
- 2nd line: Your choice — 20 characters/spaces max.
- Brands in an area 1/2" x 3"
- Border included
- Other models and free brochure available

Order anytime by phone or mail
NOVA TOOL CO.
 4533 Collax Circle, Dept. BHC
 P.O. Box 29341, Lincoln, NE 68529
 (402) 464-0511

PANEL RAISER™

Zac's carbide tipped **PANEL RAISER™** bits come in 3 styles, OGEE, COVE, & PROVINCIAL. All 1/2" shank bits are 3-1/2" in diam. w/BB & give a full 1-1/2" raised panel, \$99.50 ppd. All 1/4" shank bits are 2" in diam. & give a 1" or larger raised panel cut, \$65 ppd. To order CALL 800-441-0101 in NY call 212-947-4496.

ZAC PRODUCTS INC.
 533 WEST 34 ST.
 NYC, NY 10001

Make **Signs?**

If you make or are interested in wood signs, you'll want SignCraft — the magazine for the sign artist. You'll see creative wood signs in every issue — carved, routed and sandblasted — plus how to's, pricing, technical help and more! Your satisfaction is guaranteed.

6 issues per year, just \$21. Outside the U.S. — \$24 (U.S. funds)

SignCraft Magazine
 P.O. Box 06031-W, Ft. Myers, FL 33906

BUILD THIS UNIQUELY DESIGNED TAKE APART PLAYHOUSE

DISASSEMBLES INTO 3 PIECES
 EASY TO STORE 48"H x 36"W x 45"D

#581 TAKE APART PLAYHOUSE

theWORKSHOP BLUEPRINT COMPANY \$7.25
 P.O. Box 65725 Plus \$1.50 Postage & Handling
 West Des Moines, Iowa 50265 Iowa Res. Add Sales Tax

HORTON BRASSES
 Nooks Hill Road, P.O. Box 120J
 Cromwell, CT 06416 (203) 635-4400

HORTON BRASSES are authentic copies of 17th, 18th, 19th & early 20th century pulls

Mfrs. of Cabinet & Furniture Hardware for Homes & Antiques.
 Send \$2.00 for a Catalogue.

A Complete New Combination Kit for Whittling and Carving By **WARREN TOOL CO., INC.**

BASIC WOODCARVING

Basic Woodcarving lesson book, prepared by the National Carvers Museum, teaches and illustrates proper carving techniques through clear instructions and simple projects.

#COMBI-TCE \$79.95 Ppd.
 OUR FINEST COMBINATION WHITTLERS AND CARVERS KIT
 Contents: 1 Redwood Box, 1-#CWH-R Rosewood handle, 1 #L-Palm Walnut handle, (one each) #PTV-1, #LBG, #SBG, #PTV-2, #STC, #STG, #SFTG, #SKU, Gouges, 1-#LD2 (Large Blade), #6SBL (6-Small Blades), 1-Leather Strop Block, 1-Abrasive Paper Block, 1-Instruction Sheet. All blades and gouges sold in their own plastic storage tubes to avoid damage to these honed ready-to-use tools.

WARREN TOOL CO., INC.
 Rt. 1, Box 14A-W, Rhinebeck, NY 12572
 Catalog 60¢ FREE with order • (914) 876-7817

CLOCK COMPONENTS

QUARTZ CLOCK MOVEMENTS

WE FEATURE BATTERY, PENDULUM, CHIME QUARTZ MOVEMENTS OF ALL TYPES. UR-GOS, HERMLE, GRANDMOTHER, GRANDFATHER CABLE DRIVE AND CHAIN DRIVE, KEY WIND MOVEMENTS OF ALL TYPES. 400 DAY CLOCKS, MUSIC BOX MOVEMENTS, FLAT AND BEZEL TYPE DIALS—PLUS A VAST ASSORTMENT OF WEATHER INSTRUMENTS. HUNDREDS OF CLOCK ITEMS. VERY COMPETITIVE PRICES. WRITE OR CALL FOR FREE 75 PAGE CATALOG. \$2 FOR AIR MAIL.

THE QUARTZ FITUP THE MINI QUARTZ

Send To:
NEWPORT ENTERPRISES INC.
 2313 W. Burbank Blvd.,
 Burbank, CA 91506
 (213) 845-0555

SHOP SAFETY

Circuiting for safety

Continued from page 85

Allocating the circuits as described allows operation at full efficiency, protects motors from heat buildup, and guards your home against overload.

A sure-shot shop wiring solution

If you want to upgrade your shop wiring to handle *any* woodworking situation, we recommend adding a sub-panel with either 40-amp or 60-amp capacity. Though this setup is more costly than running circuits directly from the service panel, it guarantees convenient access and space for needed tool circuits, as well as shorter runs, which reduce voltage drop to your electrical equipment. This type of arrangement offers another great feature—the panel can be shut off and locked to guard against unmonitored use of your power tools.

Note: While it's possible to include all your shop circuits in the subpanel, we think it best to run a 15-amp lighting circuit directly to the main service panel so you won't be inadvertently left in the dark when shutting down the workshop.

Study the model shop wiring illustration on page 83 to see how we ran all the circuits.

Other planning pointers to consider

Beyond shop circuitry, safety hazards lurk in inadequate or outdated wiring, undersized extension cords, and improperly grounded outlets. The following will help you eliminate these dangers:

- **Use only copper wire.** Aluminum wire, your other option, requires special installation procedures. Otherwise it can react with normally used hardware, causing deterioration of the insulated coating and a possible electrical short. Other than price, aluminum wire offers no advantages indoors.

Continued



This VET Did It – and YOU Can Do It Too!

"War injuries left me badly handicapped, but now I'm a financial success as a Locksmith, thanks to your training. Besides, the work is fascinating. If I can do it anybody can." — Glen Johnson, Larned, Kan.

Make Up to \$26.00 an Hour — even while learning!

Train FAST at Home!

Be a LOCKSMITH!

If you enjoy fixing things, you're a "natural" to make hundreds of EXTRA DOLLARS a year in the fascinating business of Locksmithing. Rising crime has increased demand for service a thousandfold. Yet there's only one Locksmith for every 17,000 people!

COLLECT CASH PROFITS ALMOST AT ONCE!

You're "in business" ready to make \$10 to \$26.00 an hour a few days after you begin Foley-Belsaw's shortcut training. Easy illustrated lessons complete with ALL practice equipment PLUS

- ALL TOOLS YOURS TO KEEP
- KEY MACHINE YOURS TO KEEP
- EXPERT PERSONAL ASSISTANCE
- BUSINESS-BUILDING HELP



FREE

MAIL THIS COUPON • NO SALESMAN WILL CALL

FOLEY-BELSAW INSTITUTE, 10763 Field Bldg. Kansas City, Mo. 64111



Rush FREE book, "Keys to your Future."

Name _____

Address _____

City _____ State _____ Zip _____

THIS DO-ALL PRO KEY MACHINE YOURS TO KEEP!

Can add \$50 to \$100 a week to your income... and doesn't cost you a penny extra!

FREE

Ken's NEW full scale plans with photos and easy step by step instructions

Wooden Memories T.M.

EDITION NO. 6
Grandma's House
(PART TWO)

Children's furniture which brings fond reflections. They can pump hours of entertainment out of a dry sink with a pitcher pump and pantry cupboard. Loads of storage space for toys, dishes, clothes, etc.

All plans for **\$16.00** US FUNDS ONLY
PA RESIDENTS ADD 6% SALES TAX



Mailed 3rd Class FREE.

For 1st Class postage add \$2.50. Canadian orders must include 1st Class postage. Other countries add postage for 1 lb. parcel.

WOODEN MEMORIES Dept. W Box 490 Russell, PA 16345

EASY WOOD FINISHING
with
WATCO®
The Original
DANISH OIL FINISH

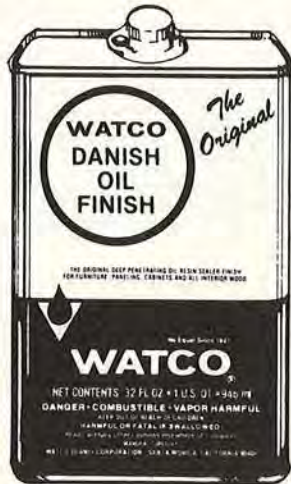

You'll be amazed at how easy it is to finish wood beautifully with Watco Danish Oil. Watco gives wood that natural hand-rubbed look with long-lasting durability. And because Watco is **IN** the wood... not on it like temporary surface coatings... there is no finish that will wear off. Watco Danish Oil is ideal for furniture, antiques, paneling, cabinets, doors, and trim-work. It's also safe for butcher blocks, cutting boards, and children's toys. Choose from 8 beautiful finishes... Natural, and Medium, Dark, and Black Walnut shades, and Cherry, Golden Oak, Fruitwood, and English Oak colors.

Send today for "FREE" color booklet "HOW to Beautifully Finish Wood" and the name of your nearest Watco distributor.

WATCO-DENNIS CORP., 1756-22nd St.
Santa Monica, CA 90404, Dept. BH-W115

Name _____
Street _____
City _____
State _____ Zip _____

213/870-4781

DON'T MISS OUT!

The **GENERAL** 10" Tilting Arbor
Table Saw

To Order Call
Toll-Free **1-800-387-9789**



10" TILTING ARBOR TABLE SAW
c/w 3 HP Motor,
Magnetic Control, Guard,
Guide Rails and Fence.
425 lbs. Ready to use.

Crafted to exacting standards to assure you of years of unexcelled performance. A state-of-the-art table saw with a 40-year tradition of quality woodworking machinery production.

10" Tilting Arbor Table Saw Specifications

Maximum depth of cut	3 3/4"
Diameter of arbor	3/4"
Diameter of saw blade	10"
Saw tilts to right	45°
Maximum depth of cut at 45°	2 3/4"
Maximum cut to right of saw	25"
Maximum width of cut-off (1" stock)	14 1/2"
Maximum cut to left of blade	15 1/2"
Maximum width of dado	1"
Distance in front of blade maximum cut	12 1/2"
Maximum length of cut with extra long guide bars	50"
Table height	34"
Table size	28" x 36"
Overall dimensions with guide bars and rip fence:	
Width	45 1/2"
Length	40"
T-slot miller gauge groove	3/8" x 3/4"
Rip fence	Locks both ends
Speed of saw blade	4000 Rpm
Motor TEFC, 3600 Rpm	3 HP
Shipping weight	385 lbs

We've sold hundreds of this rugged heavy-weight. For the dedicated woodworker, this saw's got it all!

GENERAL 10" Tilting
Arbor Table Saw
c/w 3 HP TEFC 3600 RPM Motor

\$1295.

Shipped freight collect • No other charges

VISA SEND FOR OUR CATALOG OF OTHER FINE WOODWORKING MACHINES **MasterCard**

J. Philip Humfrey Ltd.

3241 Kennedy Road, Unit 7
Department WM 11/12A
Scarborough, Ontario M1V 2J9 (416) 293-8624

I enclose \$1.00 (refundable against purchase).
Please rush my catalog.

Name _____
Address _____
City _____ State _____ Zip _____

SHOP SAFETY

Circuiting for safety

Continued

- *For safety's sake, run wires through conduit.* Electrical wires in below-grade locations and other places prone to damage should be enclosed in thin-wall conduit (EMT). In some locales, conduit's required. Other solutions, determined by code, include flexible armored cable and plastic-sheathed cable (in basement walls, cable must be rated UF for underground use. Check your local code.)

- *Protect yourself against electrical leaks and power surges.* In a damp location, such as a basement, a minor leak (or fault) can build to deadly shocking potential, even on a traditionally grounded circuit. This happens primarily with hand-held electric tools. To prevent shock, install a ground-fault circuit interrupter (GFCI) breaker in the subpanel or GFCI receptacles in outlet boxes. GFCI's shut off voltage instantaneously at the first sign of a leak. They also safeguard your power tool motors from the damaging effects of a sudden power surge.

- *Don't crisscross your shop with cords.* Rather than snake extension cords around, install a power bar (strip outlet) with multiple outlets, or try spring-loaded drop cords placed conveniently throughout your shop. If you must use extension cords, be sure they are the three-wire type (one wire is a ground) so they can handle any tool you plug into them.

For further information

We recommend these books available at bookstores and libraries:

- *Practical Electrical Wiring* by H.P. Richter, McGraw-Hill, New York, N.Y. \$27.95.
- *Better Homes and Gardens® Step-By-Step Basic Wiring*, Meredith, Des Moines, Ia. \$3.95.
- *Basic Wiring, Time-Life*, Alexandria, Va. \$11.95. ■

Written with Bill Jones

Illustration: Bill Zaun

Introducing *Fine Woodworking's* Home Video Workshops

Now you can learn woodworking directly from experienced craftsmen—in your own home, at your own pace. These videotapes capture so much detailed, practical information, you'll want to come back to them repeatedly in the years ahead.

Dovetail a Drawer *with Frank Klausz*

Cabinetmaker Frank Klausz demonstrates and explains each step in making a clean, easy-to-use drawer, from cutting the stock to gluing-up and fitting.
Approximately 60 minutes, \$49.95 postpaid

Bowl Turning *with Del Stubbs*

Here's a chance to learn bowl turning from one of the leading woodturners in the country. Stubbs demonstrates and explains all about the basic equipment, tools and techniques you need to turn a chunk of wood into a handsome bowl.
Approximately 120 minutes, \$59.95 postpaid

Carve a Ball-and-Claw Foot *with Phil Lowe*

A specialist in period woodworking, Phil Lowe shows you how to design and make that hallmark of 18th-century furniture, the cabriole leg with a ball-and-claw foot.
Approximately 115 minutes, \$59.95 postpaid

Radial-Arm-Saw Joinery *with Curtis Erpelding*

The craftsman who's brought fine joinery to the radial-arm saw demonstrates the jigs and techniques he uses to make impeccable joints time after time.
Approximately 110 minutes, \$59.95 postpaid

Wood Finishing *with Frank Klausz*

Klausz shares 20 years of finishing experience, demonstrating how to stain, oil, varnish, lacquer and French polish your work, and how to refinish older pieces.
Approximately 110 minutes, \$59.95 postpaid

To order: Mail this completed form to The Taunton Press, 63 South Main Street, Box 355PV11, Newtown, CT 06470. Or call 1-800-243-7252, and use your credit card.

Name _____

Address _____

City _____

State _____ Zip _____

Qty.	Video Workshops	Amt.
	Dovetail a Drawer with Frank Klausz \$49.95	
	Bowl Turning with Del Stubbs \$59.95	
	Carve a Ball-and-Claw Foot with Phil Lowe \$59.95	
	Radial-Arm-Saw Joinery with Curtis Erpelding \$59.95	
	Wood Finishing with Frank Klausz \$59.95	
	CT residents add 7½% sales tax.	
	TOTAL ORDER \$	
	U.S. funds please.	

All tapes should be: VHS Beta

Payment Enclosed (U.S. funds, please)

MasterCard VISA Am. Exp.

Charge Card # _____

Exp. Date _____ Signature _____

Satisfaction guaranteed.



WOODWORKING WORLD

TWO *SUPER* SHOWS

CAROLINA SHOW

CHARLOTTE CIVIC CENTER, CHARLOTTE, NORTH CAROLINA

Friday, November 15 - 2 pm - 9 pm ● Saturday, November 16 - 10 am - 6 pm ● Sunday, November 17 - 10 am - 5 pm

MACHINERY - POWER TOOLS - HAND TOOLS - WOODS - SUPPLIES & MUCH, MUCH MORE!

EVERYTHING FOR THE WOODWORKER

SAN FRANCISCO BAY AREA SHOW

OAKLAND CONVENTION CENTER, OAKLAND, CALIFORNIA

Friday, December 6 - 2 pm - 9 pm ● Saturday, December 7 - 10 am - 6 pm ● Sunday, December 8 - 10 am - 5 pm

MACHINERY - POWER TOOLS - HAND TOOLS - WOODS - SUPPLIES & MUCH, MUCH MORE

FOR

ALL ASPECTS OF WOODWORKING

INTRODUCING

WOODEN BOATBUILDING, HOMEBUILDING & MINIATURES

FREE SEMINARS WITH ADMISSION

ADMISSION \$5/\$1 OFF WITH THIS AD

FOR MORE INFORMATION AND SEMINAR SCHEDULE

WOODWORKING ASSOCIATION OF NORTH AMERICA ● P.O. BOX 706 ● PLYMOUTH, NH 03264 ● (603)536-3876

RIPSTRATE®

**The Finger Saver
That Saves Work
And Improves the Job**

Most safety devices require frequent adjustment. They usually wind up in a corner, not saving anything at all.

The RIPSTRATE guides the work against the fence. It requires no adjustment. No hands near the blade. No leaning over the saw table. No spoiled stock. NO KICKBACKS. No hassle. Just straight, clean cuts.

No wonder thousands of woodworkers, from amateur and professional craftsmen to large corporations, to government institutions, to colleges, to Air Force bases, now regard the RIPSTRATE as an essential part of their woodworking shops. After all, we are only born with ten fingers.

30 day money back trial. One year guarantee. \$62.50 plus \$3.50 shipping. Check, M.O., Visa or M/C. Free brochure.

Write or call our toll free number.
800 421 0256

FISHER HILL PRODUCTS
4 Fisher Hill
Fitzwilliam NH 03447



Dealer inquiries invited.

**The only thing small about
this bandsaw is the price!**



The new BS-3 Benchtop Bandsaw is BIG...BIG in capacity, performance, convenience *and* quality...yet it takes up just 1½' x 3' of bench space. Its built-in disc sander adds the BIG advantage of sanding right on the saw. BIG 15" throat. BIG 6¼" cutting depth. BIG quiet-running 3-speed motor has plenty of power for Wood, Metal or Plastic. BIG 16" x 18" worktable tilts up to 45°. This BIG 86 lb. Benchtop Bandsaw comes with a built-in vacuum hook-up,

emco USA

Dept. BWA5B • 2080 Fairwood Ave.
P.O. Box 07795 • Columbus, OH 43207

1-800-521-8289
(In Ohio: 614/445-8382)

a BIG list of accessories (drum and belt sanding, and more) ...and BIG Buyer Protection.

Call or write today. If you think that high quality has to mean high price ...you're in for a real surprise.

GIFT IDEA

For those who enjoy
beautiful and useful things.

Wood has information,
instructions, helpful tips,
ideas and much, much more
for beginning and
experienced woodworkers.

SIX ISSUES YEARLY

Better Homes and Gardens®

WOOD

THE MAGAZINE FOR HOME WOODWORKERS

MAKITA • PORTER CABLE • ROCKWELL • BOSCH • LION
HILLER HARDWARE CO.

ASSURES YOUR SATISFACTION ON ANY
ITEM PURCHASED FROM US! WE CAN
SHIP YOUR BANK CARD ORDER TODAY

DELTA SPECIALS

	Model	Price
10 in Tilting Arbor Saw	34-429	899.00
10 in Unisaw 3 H.P.	34-763	1599.00
H.D. Wood Shaper	43-371	1879.00
8 in Joiner Long Bed	37-315	1399.00
New 18 in Scroll Saw	40-601	949.00
Sawbuck	33-150	525.00
Unifeeder	34-150	449.00
13 in Planer RC-33	22-651	1299.00
14 in Band Saw Complete	28-283	699.00
6 in x 48 in Sander Complete	31-730	1239.00
1 H.P. Dust Collector	50-180	365.00
15 in Drill Press	15-091	369.00

25% OFF DELTA CARBIDE SHAPER CUTTERS

- WE HONOR ALL FREUD NATIONALLY ADVERTISED SPECIALS
- CALL OR WRITE TODAY FOR CURRENT PRICES ON OTHER TOOLS/ACCESSORIES
- VISA, MASTERCARD ACCEPTED

HILLER HARDWARE CO.

1411 ASSEMBLY STREET, P.O. BOX 1762
COLUMBIA, S.C 29202-1762
803-779-3131 EXT. 12

YOUR WOODWORKING SPECIALIST IN THE SOUTHEAST

HEGNER • STANLEY • GREENLEE • HENCKELS • MERIT

FREUD • MARPLES • RECORD • WATCO • NU-LIFE • DOWEL-IT-CLESCO • GILLESPIE • BLACK & DECKER • MILWAULKEE • FORSTNER • JORGENSEN • 3M • W.L. FULLER



No wonder this is my bestselling workbench. Look what you get for \$249.95!

Mortimer V. Schwartz, President, The Fine Tool Shops

SAVE \$200*

**It's made in Sweden. It's over 4 feet long.
And you won't find a finer
4' bench anywhere —
GUARANTEED!**



HOLD-DOWN CLAMP Use it on the benchtop or in the slotted "deadman" leg to secure oversize pieces horizontally or vertically. Pivoting nylon pad grips almost any shape piece firmly.
\$19.95



*Off 1984 price

- 33 1/4" high
- 50 1/4" long
- Tail vise capacity between dogs, 50 1/4"

**SAVE
44%!**

At \$450 this was my best selling workbench. And no wonder. It has a laminated beech top, 5 drawers, a lockable cabinet, and the useful Swedish system of tail vise and multiple "dogs" to grip stock as thin as 1/4".

The joints are dovetailed. It's finished with 5 coats of lacquer. The pivoting pad on the shoulder vise grips even irregular pieces firmly.

It's a fine bench at a super price. But don't take my word for it. Try it for 90 days. Then if you don't agree it's all I say, return it for a full refund. If you can part with it.

ORDER TOLL FREE 1-800-243-1037 (in CT, 797-0772)

The Fine Tool Shops, Inc., Dept. WM25
20 Backus Avenue, Box 1262, Danbury, CT 06810

YOU'RE ON! Send me _____ (qty.) 4' Swedish Workbench(es) #400-0110 for just \$249.95 plus \$40.00 shipping & handling

INCLUDE _____ (qty.) Hold-Down Clamp(s) #400-0320 for \$19.95 plus \$2.00 shipping & handling

My check for \$ _____ is enclosed.
Charge my VISA MasterCard AmEx

Account # _____ Exp. Date _____

Name _____

Address _____

City, State, Zip _____

Send me your full color catalog of woodworking tools, workbenches and accessories — **FREE!**

WOOD ANECDOTE Print this article

CAMPBORWOOD It fights moths and stuffy noses, and keeps your silver shiny



Centuries ago, the unsanctioned cutting of a camphor tree in China or Formosa (Taiwan) was punishable by death. That's because camphorwood (*Cinnamomum camphora*), native to those countries as well as to Japan, was reserved for sacred ceremonial items such as the Chinese *mu-yu* drum used in temples. But *chang-mu*, as the wood is called in China, eventually flourished in foreign trade. Ship captains and other seafarers sought it for their sea chests to ward off moths.

Perhaps it was sawyers cutting camphorwood who discovered that its scent also opened up stuffy noses. Word of camphorwood's reputedly powerful medicinal properties spread to Europe and America, and soon even common folk considered it a cure-all. Indeed, the medicinal compound called camphor, refined from the tree bark, eventually found its way into ointments for the relief of muscle

spasms and nasal congestion.

Today, chemical substitutes replace much natural camphor, but stiff competition still erupts between lumber buyers and drug manufacturers when camphorwood comes up for sale. While you won't find camphorwood at lumberyards, it occasionally finds its way to dealers of exotic woods. If you happen upon some, you'd be wise to work it into a silverware chest—camphorwood keeps silver from tarnishing.

The camphor tree, an evergreen, grows slowly. It takes 50 years or more before one becomes large enough to distill camphor from its bark. In that time, the tree can reach 100' tall, with the spread of its branches frequently double its height. A mature tree also develops many large burls, which, as veneer, becomes marquetry and facing for very expensive paneling. ■

Photograph: Bob Calmer
Illustration: Jim Stevenson

Quality Tools!



MAKITA 9820-2 BLADE SHARPENER

\$195.00 Postpaid *
Sharpens planer and jointer knives with great speed and accuracy. Medium grit Japanese waterstone rotates in gravity-fed bath for safe work on your edge tools.

New GREEN WHEEL for 9820-2. 120-grit coarse silicon-carbide wheel re-shapes bevels and grinds out nicks; also sharpens carbide knives. \$35.00 postpaid.

* SPECIAL thru Dec. 31, 1985 FREE GREEN WHEEL with purchase of 9820-2

Optional Accessory Jig (shown in use in photo) for sharpening chisels and plane irons. \$12.50 postpaid.



FORSTNER BITS

Set of 7 \$49.95 Postpaid

Premium Schlager Forstner bits are carefully engineered & precisely machined to cleanly drill flat-bottomed holes even in difficult grain, delicate veneer, or denser hardwood. Inside beveled circular rim guides the bit for consistent cutting action, allowing overlapping holes for mortising or grooving. Set includes 1/4", 3/8", 1/2", 5/8", 3/4", 7/8", and 1" sizes packed in a wooden case.

SET OF 15 includes 7 sizes above plus 1-1/8", 1 1/4", 1-3/8", 1 1/2", 1-5/8", 1 3/4", 1-7/8" & 2". (All shanks are 3/8" or less). \$179.95 ppd.



RECORD VISES

Discover the difference these heavy-duty quick-action vises can make in your shop. Ruggedly built for a lifetime of heavy use.

WISE	Quick Action	Dog	Jaw Width	Jaw Opening	Weight	POSTPAID PRICE
52E	Yes	No	7"	8"	19 lbs.	\$49.95
52 1/2 D	Yes	Yes	9"	13"	36 lbs.	\$95.00
53E	Yes	No	10 1/2"	15"	38 lbs.	\$95.00



MAKITA 3612BR PLUNGE ROUTER

\$199.95 Postpaid

Powerful 14 amp motor plunges up to 2 1/2", controlled by 3 adjustable depth stops. Handles 1/4", 3/8", and 1/2" router bits.

Optional guide holder, straight guide & roller guide \$24.50 ppd.

Ogee Fillet Raised Panel Router Bit

\$99.95 Postpaid

2 1/2" diameter carbide router bit is ideal for all panel raising. 1/2" shank.

RAIL & STILE BIT

\$89.95 Postpaid

This 1/2" carbide bit re-configures as shown at right to cut both a rail & matching stile in 3/4" stock. Ideal for use with Ogee Fillet bit above.

Set of both bits (Ogee Fillet & Rail & Stile) \$175.00 postpaid.

LAMELLO PLATE JOINTER

\$525.00 Postpaid

Patented design and Swiss precision make the Lamello the fastest and most accurate plate joinery tool on the market. Positions instantly for rapid assembly and maximum joint strength.

Lamello Jointing Plates (boxes of 1000) \$27.50 postpaid
Specify size 0 (9/16" wide), 10 (3/4" wide) or 20 (1 1/16" wide).



highland hardware

1045 N. Highland Ave. NE Dept. B
Atlanta, GA 30306 (404) 872-4466



BEVEL EDGED CHISELS

Set of 4 \$16.95 Postpaid

Marples Blue Chip-quality chisels fitted with sturdy ash handles, offered at a remarkably low price. Set of 4 includes 1/4", 1/2", 3/4" and 1" sizes in a plastic wallet.

HSS TURNING TOOLS

Set of 6 \$79.95 Postpaid

Top quality Henry Taylor High Speed Steel tools take a sharp edge and stay sharp much longer than carbon steel tools. Set includes 1/4", 3/8" & 1/2" spindle gouges, 3/4" roughing out gouge, 1/2" skew, and 1/8" parting tool.



MAKITA PLANERS

New 2030N Planer-Jointer

New 2030N combination 12 1/2" 2-speed auto-feed planer and 6" x 59" longbed jointer features sturdy 4-post construction, 2hp 115v motor and side sawdust discharge. Call for Price



2040 Thickness Planer

Model 2040 15-5/8" auto-feed thickness planer has 7-5/8" maximum thickness capacity. 2hp 115v motor. Weighs 254 lbs. Call for Price



We offer fast, reliable mail order service on a wide range of top quality imported woodworking tools, including Makita, Hegner and Freud products. We are also exclusive Inca dealer for Northern Georgia.

MC/Visa users outside Georgia

ORDER TOLL FREE

(800) 241-6748

(Orders Only)

Or send check, money order, or Mastercard/Visa info to Highland Hardware. Prices are postpaid in U.S. Offers effective through Dec. 31, 1985.

MAIL \$1.00 FOR OUR CATALOG (free with order) and receive FREE a year's subscription to Wood News, our lively and informative customer newsletter.

For the Serious Woodworker...
No more changing blades for rip, miter and crosscut — or for different kinds of material!

The WOODWORKER TWINS Make Every Kind of Cut A Lot Better And A Lot Longer!

We regretfully announce that Mr. Sawdust has separated himself from Forrest Manufacturing's sawblades so that his name will no longer appear. Quality and specifications remain unimpaired as always.

WOODWORKER I (For the ONE-Saw Shop) This is my original Woodworker blade — most desired by the American craftsman. Kerf: 3/32", 60 teeth. Modified triple-chip with micro-finish grind. Exclusive Forrest 400 carbide. Perfect, polished cuts in every direction. The one blade that does it all — for as long as you'll cut wood or plastics. Designed for use on either table — or radial — saw. A MUST for your radial. Available in 8", 9" and 10" diameters.

WOODWORKER II (For the TWO-Saw Shop) My new ALL PURPOSE blade — primarily for your table-saw 1/8" kerf. 30 to 40 teeth (see below). Modified alternate-bevel with micro-finish grind. Exclusive Forrest 400 carbide. Designed for super-fast and planer action in ripping heavy, solid stock with glue-line quality of cut. We rip 2" Red Oak with 1 HP at the shows leaving surface smoother than a planer. Slices ply-panels, particle-board and one-side laminates quick and clean. Crosscuts and miters with equal quality and ease and no bottom splintering. Generally, I recommend 40 teeth. However, if your ripping includes a lot of heavy 1 1/2" to 2" hardwoods, specify 30 teeth. See dampener information. Available in 8", 9" and 10" diameters.

We're proving everything we say in our ads — in major shows across the country.

DAMPENER-STIFFENER One Side Aids A Smoother, Quieter Cut!

• Holds blade rigid and true for better cuts on your machine. • Dampens out motor and belt vibrations from being transmitted up to the rim of the teeth causing scratchy cuts. • Greatly reduces cutting noise. • Helps kill saw scream-whistle from any vibrating blade surface. • Is hardened and precision ground parallel and flat within .001" to keep your blade true.

• Can be removed instantly if need requires for deep cuts. • One against the outside leaves blade centered in slot of steel table insert. • 6" dampener on 10" blade gives 2" cutdepth. Use 5" dampener if always in 1 1/2"-2" deep cuts. Remove or use 4" for 3" cuts. For 8" and 9" blades, figure dampener size accordingly.

6" Dampener \$23 • 5" Dampener \$22 • 4" Dampener \$20

Jim Forrest, President and designer, microscoping cutting edge.

WOODWORKER I

	WAS	NOW 40% OFF
10" 60T	\$162	\$97
9" 60T	156	94
8" 60T	150	90

WOODWORKER II

	WAS	NOW 40% OFF
10" 40T	\$156	\$94
30T	135	81
9" 40T	146	88
30T	125	75
8" 40T	136	82
30T	115	69
7 1/4" 30T	112	56

WE RECOMMEND OUR FACTORY SHARPENING... 2-3 DAYS ON THESE AND ALL MAKES OF CARBIDE TIP SAWS.
NOW... ORDER the one blade that will outlast you! (10-20 sharpenings possible).

Your cutting satisfaction guaranteed or full cash or credit refund
FORREST MANUFACTURING COMPANY, INC.
250 Delawanna Ave., Clifton, NJ 07014

Dealer Inquiries Welcome.

FORREST

We honor Amex, Visa & MasterCard,
Money Orders, Personal Checks and CODs.

TO ORDER PHONE TOLL FREE!

1-800-526-7852 (In NJ: 201-473-5236)

ASSOCIATIONS YOU SHOULD KNOW ABOUT

THE NATIONAL CARVERS MUSEUM



If you didn't already know, you'd never suspect that the National Carvers Museum (NCM) happens to be an organized, motivated, and dedicated association of 32,000 woodcarvers first and a "museum" second. From all 50 states and 17 foreign countries, these carvers unite in their goal "to foster, cultivate, promote, sponsor, and develop the understanding of the art, craft, and skill of woodcarving, past, present, and future."

Harry K. Meech, president of the National Carvers Museum Foundation, a non-profit corporation that directs activities and handles day-to-day business for NCM, says that members actively support their museum and the association because "it's a labor of love." In turn, Meech sees to it that NCM "does whatever it can to help carvers."

Headquarters for NCM is Monument, Colorado, just a stone's throw from the U.S. Air Force Academy. Gigantic Monument Rock provides the backdrop for a museum built in 1972 with funds raised by members. Its 10,000 square feet of exhibit space displays the work of 6,000 carvers from all over the world. In July of this year, NCM dedicated an educational wing, again built through members' help. Future plans call for a gallery to show work of top professional carvers. (The museum, open daily year-round, is located west of I-25 at Exit 158.)

Through NCM, members have access to carving tools and supplies, mail-order courses, and woodcarving seminars and classes held at the museum in Monument. Besides various carving how-to books published by NCM—available to members at reduced cost—membership includes a subscription to *The Mallet*, a monthly 64-page magazine of news, tips, and instruction. Annual memberships begin at \$10 and feature a carving course, materials, and tools (various advanced memberships with more benefits are proportionately higher). Life and sustaining memberships are also offered. For more information, write: *National Carvers Museum, Dept. W, 14960 Woodcarver Road, Monument, CO 80132.* ■

The INCA Woodworking Machinery Handbook

with useful tips and jigs for everyone!

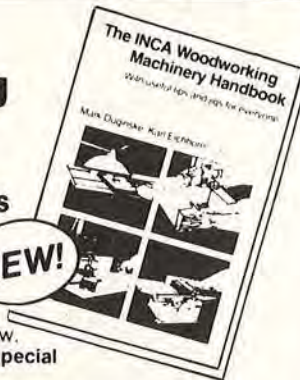

Recommended for all power tool woodworkers. The joinery book for all present or prospective INCA owners. Now, at a Special Price! List - \$12.95 **Special \$9.95 ppd. A \$3.00 Savings!**

Many ideas for jigs, including Dovetails, Finger Joints, Pattern Work and many more are shown in over 300 illustrations. For your Table Saw, Bandsaw, Jointer, Planer & Shaper.



Drawer Dovetails Cut on Table Saw



Copying Curves Using Bandsaw

Return in 30 days for refund if not satisfied.

Send me the INCA Machinery Handbook at \$9.95 each.
 Check Enclosed Charge to my: VISA, M/C, Amex
 Card #: _____ Expires: _____
 Signature: _____
 Name: _____
 Address: _____
 City: _____ State: _____ Zip: _____

Send to: The Garrett Wade Co., Inc., Dept. 511
 161 Avenue of the Americas, NY, NY 10013
 Offer Expires 1-1-86

PORTER-CABLE • HITACHI • MAKITA

BLACK & DECKER COMPOUND MITER SAW

- Compound miter
- 1 1/4 hp
- Rotating table, 5 1/4" width of cut
- 2-year warranty

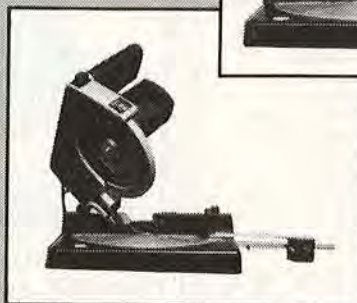
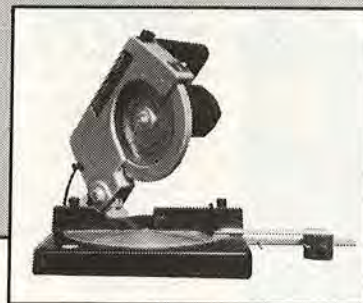

List 278⁰⁰
 FREIGHT PAID

SALE
\$125⁰⁰

NAT'L WATTS
 800-874-8160

FLA WATTS
 800-342-2641

BRATTON MACHINERY & SUPPLY
 1015 Commercial St. • P.O. Box 20408W • Tallahassee, FL 32316
 Lowest Prices Anywhere! • Visa/MasterCard

HITACHI • MAKITA • POWERMATIC • ROCKWELL/DELTA

POWERMATIC • ROCKWELL/DELTA • PORTER-CABLE

MAKITA • POWERMATIC • ROCKWELL/DELTA

Have a problem with your subscription?

We want to solve it to your complete satisfaction, and we want to do it fast. Please write to: Robert Austin, *Better Homes and Gardens*® WOOD, P.O. Box 10628, Des Moines, Iowa 50336.

You can help us by attaching your magazine label here, or copy your name and address as it appears on your label. Send this along with your correspondence.

Name _____		
Address _____		Apt. # _____
City _____	State _____	Zip _____

Moving? Simply attach the mailing label from this magazine and write in your new address below. (Please allow 4-8 weeks.)

Your New Address Goes Here

Name _____		
Address _____		Apt. # _____
City _____	State _____	Zip _____

Subscription Rate:

6 issues — 1 year — \$15. Add \$6 for Canadian or foreign postage.

Renewal New Order

Need Faster Service?

Do us a favor...it is better to write us concerning your problem and include the magazine label. Also, address changes are handled more efficiently by mail. However, should you need to reach us quickly the following toll-free number is available:

800-247-2504

Better Homes and Gardens®

WOOD

P.O. Box 10628 • Des Moines, Iowa 50336

Problem Solver Catalog

Over 1,000 Items

Solid Brass Furniture Hardware • Locks Casters • Chair Cane • Table Slides Hinges • Bed Hardware • Lamp Fittings and Much Much More

Write For Your Catalog Today!

PAXTON HARDWARE

7818 Bradshaw Road, Dept. BH3
Upper Falls, MD 21156

Free Brochure 64 page Catalog \$3.50



BUILD THIS PIE SAFE

Order plans for this country reproduction

A necessity in early American homes, today's homeowner will love the storage in this charming Pie Safe. You can stain and varnish, or finish yours with old-fashioned milk paint—instructions for both finishes are in the plans. To order, send \$12. ppd. (Canadian residents please remit postal money order in US funds) to: **HAMMERMARK ASSOCIATES**, Box 201-WN, Floral Park, NY 11002. Send \$1 (refunded with first order) for our catalog (its included free with all plans orders). Prices in effect until 12/31/85, after that date check price before ordering.

DO-IT-YOURSELF KITS

BUILD YOUR OWN GRANDFATHER CLOCK



Prices Starting **\$280**
Under (including movement and dial)

- Do-it-yourself case kit, parts pre-cut
- Finished clocks
- Solid 3/4" hardwoods: black walnut, cherry, oak
- Heirloom quality
- Factory direct prices
- Solid brass West German chiming movements
- Money back guarantee
- Prompt shipment
- No woodworking experience necessary

WRITE FOR FREE COLOR CATALOG



EMPEROR
CLOCK COMPANY

WORLD'S LARGEST MANUFACTURER OF GRANDFATHER CLOCKS

Dept. 1732, Emperor Industrial Park
Fairhope Alabama 36532 • Phone 1-205-928-2316

I am interested in Do-It-Yourself Kits
 Finished Clocks

Name _____
Street _____
City _____
State _____ Zip _____
(please print)

WOODWORKERS

FREUD 15 PIECE CARBIDE TIPPED ROUTER BIT SET IN WOODEN BOX

\$300.00 Value



SALE
\$149.00

FREE CATALOG SUBSCRIPTION WITH PURCHASE.

CATALOG ONLY.

2 year subscription (8 issues) \$4.00.
Free \$5.00 gift certificate with catalog order.

R. A. NESS & CO.

THE WOODWORKERS EMPORIUM

8888 N. MILWAUKEE AVE.
NILES, IL 60648

(312) 824-0565



"MAKER'S MARK" BRANDING TOOL

SEND \$1.00 FOR INFO PACK!

Pr: bwy dwy grt li nst
wms: wssy blk bvsq
chit n2 ascd

NOW! Brand your own name permanently on wood and leather handcrafts! Simple to use. Long lasting U L approved electric handle.

Brands full name. Guaranteed.
WALL LENK CORPORATION
P.O. Box 3349, W-11, Kinston, NC 28502-3349

Love-Built Toys
and

The Toymaker Supply Co.

NEW — Midwest Location!
105 Weiler Rd. T11
Arlington Hts., IL 60005

NEW — Toll Free Phones!
1-800-624-3938
(In IL 1-800-358-4208)

NEW — LOW PRICES!

For Volume Purchases of Quality Toy Parts... Write or Phone Today for Fall Catalog!



Japanese Woodworking Tools: Their Tradition, Spirit, and Use

By Toshio Odate, The Taunton Press, 52 Church Hill Rd., Box 355, New-ton, CT 06470. ©1984

Japanese Woodworking Tools: Their Tradition, Spirit and Use



192 pages
\$22.95
Clothbound

A SHOKUNIN INTERPRETS THE ENCHANTMENT OF HIS TOOLS

Being a *shokunin* (Japanese craftsman), writes Odate, "means not only having technical skill, but also an attitude and social consciousness." As a former *shokunin*—specifically a *tategu-shi*, or sliding-door maker—Odate writes warmly and meaningfully about Japanese tools and craftsmen. In so doing, he displays as a writer the skill he evidenced as a *shokunin*.

From the first fascinating page of the introduction through the description of a *shigoto-ba* (workshop) and on to practically every tool in the Japanese woodworker's chest, the author masterfully interprets the tradition behind Japanese tools. This human perspective represents a finesse seldom found in woodworking libraries.

Each category of woodworking tools described begins with a tale that reads as intriguingly as passages by Pearl Buck in her books about China. Odate sets the stage, humanizes the scene, and introduces the tools almost as characters. Regarding *nokogiri* (saws), he explains that they are designed to cut on the pull stroke because the Japanese tradition is to sit or squat on the floor while working: "... it must have seemed easier to adapt the saw to a pull stroke [when it was introduced from China] than to change their traditional working postures." For these insights alone, his book rates as a must read.

"When I was a *shokunin*, we celebrated the tools every New Year's Day. We cleaned them and our toolboxes and put them in the *tokonoma* (a special, decorated corner of the house or shop). We put a small piece of rice paper on each box, and then two rice cakes and a tangerine. This simple gesture is the traditional way of thanking the tools for their hard work and for the crucial part they play in the *shokunin's* life."

New Low Prices!

Quartz Clock Movements

M88 Thinline

Made in Japan by the world's largest producer of quartz timepieces.



2-3/16" square x 5/8" thick
Step sweep hand. Uses A-A cell.

Fast Delivery!

1-\$6.00 25-\$3.60 100-\$2.95
5-\$4.50 50-\$3.35 250-\$2.60
10-\$4.25 FREE HANDS

Money Back Guarantee!

PRICES INCLUDE HOUR AND MINUTE HAND. ADD 25¢ FOR SECOND HANDS. Add \$2.00 per order for postage & handling.



New Catalog

55 pages of clock movements, dials, accessories, hands, tools, and more!
Catalog # 785 \$1.00 (Free with order)

Cas-Ker Co.

BOX 2347-R CINTI, OH 45201
PHONE (513) 241-7073



RYOBI AP-10 THICKNESS PLANNER



10" X 5" CAPACITY
26 FT/MIN FEED RATE
8000 RPM
ALL BALL BEARING CONSTRUCTION
EASILY TRANSPORTED — COMPACT & LIGHTWEIGHT — 58 LBS!!!
INCLUDES BLADE SETTING GUIDE, TOOLS, & EXTENSION ROLLERS

INTRODUCTORY PRICE
\$589.00
DELIVERED THROUGH 12/31/85

HOLD THE LINE WITH THE PARALOK FENCE



• SINGLE HANDED OPERATION •
• DOUBLE LOCKING • FITS MOST TABLE SAWS •

REGULAR PREPAID PRICE
\$364.50 to \$399.00

Texas Residents Add 6% Sales Tax.

INCA • DELTA • HEGNER • RYOBI
BOSCH • SORBY • MYFORD LATHES

Send 6¢ In Stamps For Price Lists And Brochures.

Please Call or Write For Information.

DALLAS WOOD AND TOOL STORE

1936 RECORD CROSSING 214 631-5478 DALLAS, TEXAS 75235

THE BEST PROJECTS START WITH ARTISTRY IN VENEERS!

As a craftsman, you know the advantages of fine veneers and how they can be used to create original pieces. Artistry in Veneers provides you with a complete line of quality products at affordable prices... from materials to tools, kits, "how-to" books and more!

- Veneers • Tool Kits • Stains • Marquetry • Cane • Dollhouse Kits • Fancy Crotch, Swirls, Butts and Burls • Furniture and Toy Plans • Decorative Inlays and Borders • Wood Ship Models • Waterfowl Carving Kits • Finishing Materials and Accessories • Craft and Hobby Tools • Glues and Adhesives • Wood Products • SPECIAL ISSUE - Christmas Gift Items

SPECIAL DISCOUNTS FOR INSTITUTIONAL ORDERS.



SEND \$1 FOR OUR WOODWORKER'S CATALOG (Deductible from your first order.)

ARTISTRY IN VENEERS, INC.

450 Oak Tree Avenue, South Plainfield, NJ 07080
201-668-1430

Name _____

Address _____

City _____ State _____ Zip _____

Member of Woodworking Association of North America

WOOD Catalog Review

Mail order catalogs offer a wide variety of merchandise and many one-of-a-kind items. Shop in the comfort of your own home and order with complete confidence. Your satisfaction is guaranteed.



1. 270 professionally designed full-size furniture plans. Dalcraft's 1985 catalog is a source for hard-to-find plans featuring Early American, Spanish, Modern, Juvenile, Queen Anne. Categories in family, dining and bedroom plus accent pieces. Catalog \$2.00 refunded with first order.

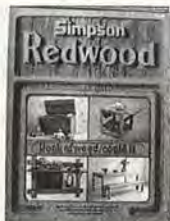

5. 36-page Redwood Book of Wood/Could It features detailed plans for 23 innovative redwood projects created by professionals in fine woodworking. Included are working drawings, tips on working with wood, plus the fascinating story of redwood. \$3.95.



9. Garrett Wade Woodworking Tools Catalog offers the finest in hand tools, finishing supplies and machinery gathered from all over the world. Hundreds of books filled with tips and information. 228-page, full-color catalog. \$3.00.



2. Cherry Tree Toys' new color catalog is chock-full of projects and supplies for toymakers and woodworkers. Included are toy plans, kits and hundreds of hardwood parts for toys, crafts and furniture—plus tools and new, non-toxic finishes. Bulk prices available. Catalog subscription \$1.00.



Kuempel
CHIME CLOCK

6. It's easy to build your own solid cherry, oak or walnut clock to treasure forever. Kuempel Chime, the originators of clock kits, has been serving clock-makers for over 65 years. Color catalog \$2.00.



10. Swedish workbenches at \$150 to \$200 savings! Big, strong benches with all the features you want—at just over half of last year's price! Order now, while a good exchange rate makes it possible. Color catalog and bonus offer. \$1.00.



3. Delta Machinery Catalog for Building Trades and Home Shops, a source for quality wood and metalworking machinery for the do-it-yourselfer and professional craftsman. A complete line of saws, drill presses, grinders, jointers, lathes, shapers and accessories. Free 44-page catalog.



7. R.A. Ness & Co., The Woodworkers Emporium, offers a two-year, eight-issue catalog subscription. Thousands of industrial quality items—machinery, hand tools, portable electric tools and supplies featured at super sale prices. Fee refundable with purchase. \$4.00.



11. Tool catalog—bandsaw, lathe, jointer/planer/shaper, table saw, dust extractor. Your partner in precision woodworking offers a complete line of equipment from Germany at competitive prices. Elektra Beckum USA Corp. \$2.00.



4. Klockit's 68-page 1985 Color Catalog includes top-quality kits, plans, tools and supplies for making attractive clocks, fine furniture, enjoyable and safe toys, lamps and music boxes. Large selection of American-made quartz clock movements, dials, hands and accessories. FREE.



8. Wholesale woodworkers hardware—save 40% on Shaker pegs, sawtooth hangers, wood wheels, dowel pins, candle-cups, spice bottles, lazy susan bearings, coat hooks and many more hard-to-find items. Send for 48-page catalog. Meisel Hardware Specialties. \$1.00.



12. Making toys and gifts for Christmas and for craft shows? Don't overlook our great selection of patterns for rocking horses, pull toys, cars, clocks and furniture. Specialty supplies also available. Armor Products. Catalog \$1.00.



13. Beautiful wood finishing with Watco Danish oil wood finish. Full-color "How to Beautifully Finish Wood" booklet enables anyone to create professional finishes the first time. Outlasts surface coats three to one. Eight colors. Eliminates pre-staining. FREE.



17. 55-page catalog shows over 25 different varieties of quartz clock movements. Features movements made in Japan by the world's largest producer of quartz timepieces. Also included are dials, hands, numerals and accessories. Most orders are shipped within one day of receipt. \$1.50.



21. Freud, manufacturer of the finest in hand-tools and carbide tools, makes these two catalogs available to you. They feature a large selection of quality chisels, carving tools, turning tools and planes, as well as carbide saw blades, router bits and shaper heads. Send for your catalogs today. \$5.00.

CASCADE PRECISION TOOL COMPANY

14. Over 200 router bits and shaper cutters displayed in catalog featuring six-piece cabinet sets, three-piece 1/2" shank router bit panel raising system, and three-wing industrial shaper cutters. Shaper cutters available in 1/2" through 1 1/4" bore with bushings. Router bits in 1/4" and 1/2" shank. Products can be manufactured according to user specification and design. \$1.00.



18. Excellence in sharpening equipment—this two-color, 56-page catalog from Foley-Belsaw Co. provides information on its complete line of equipment used for sharpening home, garden and industrial shop saws and tools. Each machine is fully illustrated; complete specs and pricing information are provided. FREE.



15. Easy Does It—with HTC's Power Tool Accessories. Discover many unique items, designed only with you, the dedicated woodworker, in mind. Make your machinery safer, increase the working area of your shop and accomplish nearly impossible tasks easily, quickly, accurately. Full-line catalog and price list. FREE.



19. 116-page catalog offers the finest in cabinet-grade hardwoods, veneers, woodworking tools and accessories, hard-to-find hardware, inlays, kits, cane, moulding, wood finishes, books, plans and more. Your best source book and reference guide for woodworkers and restorers. Satisfaction guaranteed. Prompt deliveries. \$1.00.



16. Time at its best! 100-page catalog from Craft Products shows endless variety of imported brass movements and dials, quartz movements, clock kits, specialty hardware, music box movements, weather instruments, hardwood parts and moldings, and valuable background information on clock building. Send today! \$2.00.



20. Conover's Unique Hand-made Tools: 16-page catalog of unique reproduction and hard-to-find tools, such as miniature brass palm planes, wood threading tools and spoke-shaves. These high-quality tools are made by the Conover family in Parkman, Ohio, and by dealing direct with the manufacturer you save. \$1.00.

WOOD'S Catalog Review ORDER FORM

Circle the catalogs you want. Fill out the coupon and include your check made out to Better Homes and Gardens* for the cost of the catalogs you ordered plus the \$2 handling fee. Please allow 4-6 weeks for delivery.

Circle the catalogs you want to receive:

- | | | | | | | |
|-----------|-----------|-----------|------------|------------|------------|------------|
| 1. \$2.00 | 4. FREE | 7. \$4.00 | 10. \$1.00 | 13. FREE | 16. \$2.00 | 19. \$1.00 |
| 2. \$1.00 | 5. \$3.95 | 8. \$1.00 | 11. \$2.00 | 14. \$1.00 | 17. \$1.50 | 20. \$1.00 |
| 3. FREE | 6. \$2.00 | 9. \$3.00 | 12. \$1.00 | 15. FREE | 18. FREE | 21. \$5.00 |

Send to: Better Homes and Gardens*, WOOD, Dec. 1985, P.O. Box 2051, Clinton, Iowa 52732

I am enclosing:

\$ _____ for catalogs ordered
 \$ **\$2.00** for handling
 \$ _____ total payment

Name _____

Address _____

City _____ State _____ Zip _____

Information



WORTH WRITING FOR

You can get useful ideas and product information by mail. Use the coupon in this section to order your choice of literature listed below.

SCROLL SAW AND LATHE INFORMATION — More than 20 pages of information, including full-color photos, on HEGNER precision scroll saws, HEGNER lathes, and HEGNER duplicators. Find out why these machines are considered state of the art, and what to look for when shopping for scroll saws or lathes. AMI, LTD. \$1.00. *Circle No. 2.*

OVER 400 WOODWORKING DESIGNS — We now offer thirty-one packets of blueprint plans and full-size patterns with both the home and commercial craftsman in mind. Enjoy making toys, games, children's items, whirligigs, folk art, plaques, magazine racks, shelves, kitchen and household items, birdhouses, plant stands, and more. Simple enough for the beginner, fun and profitable for the pro. Send for illustrated brochure plus sample pattern. ACCENTS IN PINE. \$2.00. *Circle No. 12.*

FOR AMERICAN-MADE TOP QUALITY WOODWORKING EQUIPMENT — Send for our catalogs on all the top American-made machinery like Powermatic. We also carry hard to find decorative hardware like Baldwin and Slage. ADDKISON HARDWARE. \$2.00. *Circle No. 15.*

MODERN HARDWARE FOR CRAFTSMEN — European concealed hinges for wood and glass doors are our specialty. No-bore glass door hinges plus everything else for your stereo cabinet from casters to lid hinges. Make your kitchen cabinets more functional with wire shelves, baskets, and slides. Build a computer cabinet using our TV extension slides. No minimum order requirements and our prices are low. ALLEN SPECIALTY HARDWARE. \$1.00. *Circle No. 30.*

THE AMERICAN WOODWORKER MAGAZINE — offers projects on beginning, intermediate, and advanced levels in each issue. Also included are in-depth instructional articles on all phases of woodworking, plus general interest articles. We will offer plans for jigs and fixtures for your shop. A one year subscription is only \$10.00 (inside U.S.). Send for our brochure giving complete details plus a coupon good for 1/3 off the regular price. THE AMERICAN WOODWORKER. \$1.00. *Circle No. 45.*

TOOL CATALOG — Available from Anglo American Enterprises, the world famous Record Marples Tool Catalog featuring the finest woodcrafting tools available. Send for catalog and price list. ANGLo AMERICAN ENTERPRISES CORP. \$2.00. *Circle No. 50.*

SHIP MODEL KITS — Fully illustrated 32-page catalog of scale ship model kits from America's oldest model ship company. Build a beautiful museum quality model ship with the simplest tools and average skills. BLUEJACKET SHIP CRAFTERS. \$2.00. *Circle No. 130.*

SAFETY IS PROFITABLE — The cost of accidents has rapidly escalated in the form of insurance premiums, medical costs, etc. Powermatic introduces an unprecedented safety use and productivity improving plan for the safe use of its products, and safety improving accessories at new special low prices. A program you will profit from. BRADY SUPPLY CORP. \$2.00. *Circle No. 146.*

WOODWORKING EQUIPMENT — More than 75 pages filled with woodworking machinery, portable power tools, and supplies. Detailed information on all types of equipment for professional and home shop needs. Powermatic, Rockwell, Hitachi, Makita, and more. BRATTON MACHINERY AND SUPPLY, INC. \$4.50. *Circle No. 150.*

CANE AND BASKET SUPPLIES — Every item

used in caning and basketry is pictured in this new catalog for hobbyists and others interested in caning, rushing, etc., for either fun or profit. CANE & BASKET SUPPLY CO. \$1.00. *Circle No. 230.*

CARBIDE TIPPED ROUTER BITS AND SHAPER CUTTERS — Over 200 router bits and shaper cutters displayed in catalog featuring 6 piece cabinet sets, 3 piece 1/2 in. shank router bit panel raising system, and 3 wing industrial shaper cutters. Shaper cutters available in 1/2 in. through 1-1/4 in. bore with bushings. Router bits offered in 1/4 in. and 1/2 in. shank. Products can also be manufactured according to user specification and design. CASCADE PRECISION TOOL CO. \$1.00. *Circle No. 245.*

WOODWORKERS TOOLS AND MATERIALS — 116-page catalog offers fine hardwoods, veneers, inlays, picture molding, wood finishes, carving blocks, cabinet hardware, and cane. Specialty woodworking tools, shop equipment, plans, instruction books. ALBERT CONSTANTINE AND SON INC. \$1.00. *Circle No. 270.*

BUILD HEIRLOOM CLOCKS — Now create beautiful heirloom quality clocks right in your own home. Choose from magnificent chiming grandfather clocks to charming wall clocks. 32-page catalog also offers a selection of music boxes, music movements, traditional barometers, and a huge variety of quartz movements and dials for custom clock building. Satisfaction guaranteed. CRAFT PRODUCTS CO. Free. *Circle No. 273.*

WOODTURNERS — Craft Supplies offers the finest selection of both English and American tools available. We feature Sorby, Henry Taylor, and Precision Machine tools and accessories. Choose from a complete line of figured woods, chucks, Harrison lathes, kits, and one-of-a-kind items. Send for our 48-page catalog and Dale Nish workshop information. Price of catalog refunded with order. CRAFT SUPPLIES USA. \$2.00. *Circle No. 274.*

SIMPLE SYSTEMS FOR WOOD STAINING AND FINISHING — A 24-page, 4-color booklet gives plenty of helpful tips for better results. Included are tips on how to apply a bartop finish in one day, prevent wood from yellowing, create stain colors, apply water clean up stains and finishes, and more. DEFT, INC. 50¢. *Circle No. 315.*

MULTI-PURPOSE HOME WOODWORKING SYSTEM — The Emco Start-2000 is a table saw, band saw, moulding machine and disc sander and you can change operations in less than 30 seconds. One big 2 hp. motor does it all. With optional accessories you can do wood turning, mortising, horizontal drilling, and more. Send for four-color information. EMCO* USA. Free. *Circle No. 402.*

EdLco — STAY IN THE WOODS WITH US — Educational Lumber Company is pleased to offer you our new catalog, stacked with excellent buys at delivered prices. Available to you are over 21 species of imported as well as domestic hardwoods, softwoods, turnings, shorts, veneers. All our lumber is kiln dried. As school shop suppliers for 34 years, we know our lumber. It is top-grade. Send today and receive your BONUS GIFT: 4 new furniture designs. EDUCATIONAL LUMBER CO., Inc. \$2.00. *Circle No. 420.*

FINE TOOL SHOPS' CATALOGS — Presently, the Fine Tool Shops publishes a new full-color catalog every three months. It illustrates the world's finest woodworking tools at prices guaranteed to be the lowest in the mail order industry. In addition, there are special discounts for continuing customers, incentive bonuses, and name brand U.S. made tools at spectacular savings. THE FINE TOOL SHOPS. \$1.00. *Circle No. 495.*

CUTTING TOOLS — Freud, USA provides the finest value in carbide cutting tools. From saw blades and boring bits to shaper heads and router bits. Our newest product — shaper heads for the half inch shaper spindle. Send for complete catalog. FREUD, USA. \$5.00. *Circle No. 560.*

WOODWORKING TOOL CATALOG — Complete 108-page catalog of hard-to-find hand woodworking tools. We have a stock of over 300 book titles and carry the Myford English wood-turning lathe. Also inventoried are wood finishes of all possible descriptions and carving tools unequaled anywhere in the United States. Send today for your ticket to woodworker's heaven. You too, can be turning out quality woodwork. FROG TOOL CO., LTD. \$1.00. *Circle No. 570.*

FULL-SIZE FURNITURE PLANS CATALOG — Illustrates and describes over 1800 plans for making furniture of quality found in museums and fine furniture stores. Plans include rollout desk, cradles, dining tables, chairs, buffets, chests, gun cabinets, poker table, children's furniture, rocking horse, spinning wheels, and more. Bill of materials exploded drawings assist the woodworker. FURNITURE DESIGN, INC. \$2.00. *Circle No. 585.*

PROJECT PLANS TO BUILD FOR CHILDREN — Extensive use of color photos plus illustrations of over 130 projects that you and your children will love. Baby cribs, wooden toys, desks, bunk beds, doll houses, and lots more are included in this readily useable reference book. GARLINGHOUSE CO. \$4.65. *Circle No. 590.*

WOODWORKERS — SAVE \$500 ON TOOLS — Instead of buying expensive power tools, purchase kits that include the parts, nuts, bolts, and full-sized patterns, with replacement parts always available. GIL-BILT kits with 5-year guarantee for everything from bandsaws to belt sanders. Send for our catalog today. GILLIOM MFG. \$1.00. *Circle No. 650.*

TRUE GRIP CLAMPS — First we took a bar clamp and put it inside a straight edge and called it our Clamp 'N Tool Guide. Then we took the straight edge and put a clamp on the bottom and one on the top and called it our Back To Back Bench Clamp. Then we got the whole idea patented to no one could copy it. Pretty smart, huh? Send today for brochure. GRISET INDUSTRIES. Free. *Circle No. 660.*

COUNTRY FURNITURE PLANS — Our catalog features 14 designs — from country pie safe to mini-barn. Also included are various products for the home workshop. Send for our latest catalog. Price of catalog deducted from your first order. HAMMERMARK ASSOCIATES. \$1.00. *Circle No. 710.*

TOOL CATALOG — Comprehensive selection of English, German, and Japanese woodworking tools. Hegner, Inca, and Makita power tools, Freud cutters and blades, and a wide selection of woodworking books also featured. Fast, reliable mail order service. Toll-free orderline. HIGHLAND HARDWARE. \$1.00. *Circle No. 730.*

BRASS FURNITURE HARDWARE — This 36-page catalog shows over 500 items of authentic reproduction hardware from the 1700's and on into this century. This fine quality hardware is a must for the furniture craftsman working on a new project, or the refinisher who needs replacement hardware. HORTON BRASSES. \$2.00. *Circle No. 750.*

IF YOU ARE INTERESTED IN FINE WOODWORKING — you will not find better machinery than that sold by J.P. Humfrey Ltd. For example, we have 100, 10-in. general tablesaws (2 HP, magnetic switch, lever-lock fence) available at \$1,295 FOB New York. Send for brochure. J. PHILIP HUMFREY LTD. \$1.00. *Circle No. 770.*

BUY YOUR SANDING BELTS DIRECT FROM THE MANUFACTURER — Industrial Abrasives is the company that gives you six free belts with every dozen ordered. But, sanding belts are not the only product we have to offer. In our catalog you will find many specialty items not readily available in your hardware store. Price of catalog refunded with first order. INDUSTRIAL ABRASIVES CO. \$1.00. *Circle No. 780.*

PORTER-CABLE
PROFESSIONAL POWER TOOLS

for the best
quality at the
best prices



Model No. 7548

**New Variable
Speed Orbital
Jigsaws**

Jigsaws feature a solid steel blade carrier and patented blade-guide assembly.

7548 Top-Handle Jigsaw
7648 Barrel-Grip Jigsaw

\$141.60



Model No. 330

Finish Sanders

330 4½ × 4½, 12,000 rpm sander

\$59.95

505 9¾ × 4½, 10,000 rpm sander

\$109.50



Model No. 630

Routers

630 1 HP, 22,000 rpm router

\$105.50

690 1½ HP, 22,000 rpm router

\$137.50

691 1½ HP, 22,000 rpm, D-handle router

\$155.00

We pay shipping costs!

Toll-Free Order Line

1-800-638-6405

W.S. JENKS & Son



738 7th St. NW
Washington DC 20001
(202)737-7490

2024 West Virginia Ave. NE
Washington DC 20002
(202) 529-6020



ELEKTRA BECKUM

ELEKTRA BECKUM

LOOKING FOR THE MOST MACHINE
FOR YOUR MONEY ??

What is the Best Bandsaw Buy ?



BAS450WRN

Your partner in woodworking, ELEKTRA BECKUM, has the perfect solution: The BAS450 18" Universal Bandsaw.

- 18" Throat with 12" height
- 1.5 HP continuous-duty motor
- 4 speed (260-690-1470-3800 fpm)
- 3/16" Blade width
- 45° Tilting table

All these features for only \$1,360
FOB Somerdale, NJ

ELEKTRA BECKUM AT THE HEART OF A GOOD JOB

See the ELEKTRA BECKUM machines demonstrated at these shows:

Detroit	Sept. 13-15
LA-WMFSF	Sept. 19-22
W. Chester, NY	Sept. 27-29
San Jose	Oct. 4-6
Chicago	Oct. 25-27

Call today for your closest dealer
1-800-223-8600

Send \$1.00 for full color catalog to:

ELEKTRA BECKUM USA CORP.

P.O. Box 24, Dept. MND

Somerdale, NJ 08083

Mason & Sullivan The Clockbuilder's Choice

IF YOU APPRECIATE EXCELLENCE IN CRAFTSMANSHIP AND MATERIALS, THEN WE SHOULD GET ACQUAINTED

And, whether you're a beginner or master craftsman, Mason & Sullivan's unique skill level approach offers you exactly as much of a challenge as you want.

At Mason & Sullivan we've built a foundation of product based on excellence of design and craftsmanship. We have expanded on that base with new reproduction designs, customer service before and after the purchase, and a guarantee that's the best in the industry. We back up what we sell and we have the resources to follow through on that promise.



VIENNA REGULATOR



HANDMATCHED LUMBER



PRECISION MOVEMENTS



SOLID BRASS HARDWARE



QUARTZ



SOLID BRASS DIALS

Send \$2 to receive a one year subscription to our 56-page color clockbuilding supply catalogue. Includes clock kits, dials, movements, weather instruments, hardware, tools, books and accessories.

Name _____
Address _____
City _____
State _____ Zip _____

Mason & Sullivan
"Serving Fine Clockmakers Since 1947"

Dept. 2363, W. Yarmouth, Cape Cod, MA 02673



Now: Own a real
Swiss shop bench
for only \$295! F.O.B.
La Mirada
Calif.



CLASSIC (SHOWN ABOVE)
VERSATILE (1 VISE, 2 DOG ROWS)
RECORD: (78-INCH)

Here's your dream workbench. It's a 60-inch Lachappelle—the bench professional woodworkers use.

Made in Switzerland by Old World craftsmen, its top is of kiln-dried red beech (harder than most oaks). It has two vises with solid guide rods gliding on steel tubes. Has all your want-most features, like big rugged steel spindles and bench dogs.

Best of all is the price—an unbelievably low \$295! Send for literature and details now. Dealer inquiries invited.

QUALITECH PRODUCTS

14742 Beach Blvd., Suite 422, Dept B65
La Mirada, Calif. 90638



✓ Yes, please rush me details about the Lachappelle Swiss workbench.



Name _____

Address _____

City/State/Zip _____

DO YOU USE OR COLLECT
FINE HAND TOOLS?

ANTIQUE — OBSOLETE — MODERN

IF SO,

YOU SHOULD BE READING



**THE FINE
TOOL JOURNAL**

PUBLISHED 10 TIMES ANNUALLY
1 Year Subscription — \$10.00. Sample, \$1.50

REMIT TO:
THE FINE TOOL JOURNAL
RD #2 — Dept. W85
Poultney, VT 05764

SAFE • EASY • PRECISE
PROFESSIONAL
WOOD CARVING



AUTO MACH
by Sugino

Compact. 10,000 vpm oscillating speed. Pressure activated. Operates on ordinary household current. Send for free brochure. Dealers inquiries invited. **\$199.00**



SUGINO USA, Inc.

2246 N. Palmer Dr. • Schaumburg, IL. • 60195 (312) 397-9401

Create A Classic



Full size patterns for Packard Le Baron and 1929 Chevy Truck, plus a catalog of over 100 wooden toy patterns, wooden wheels, axle pegs, people, and other hardwood turnings.

Send check or money order for \$10.00 for both patterns and catalog, or \$1.50 for catalog.

TOY DESIGNS - Dept. BW1185, Box 441
Newton, Iowa 50208

**REPRODUCTION
HARDWOODS**
for the home craftsman

America's Source for

- Solid Lumber Panels
- Turning Squares
- Plywood
- Butcher Block Stock

All products available in widths up to 30" and lengths to 48".
Squares up to 5" thick.

RED OAK, MAHOGANY, CHERRY,
WALNUT, HARD MAPLE, POPLAR

Stock is defect free, sized ready to use, shipped UPS to your door.

Send \$2.00 for catalog.

Route 9, Box 214-M
Morganton, North Carolina 28655
(704) 433-5490



FREE



\$7.50-1/2" CARBIDE-TIPPED DOVETAIL ROUTER BIT WHEN YOU ORDER THIS SET OF SIX TOP-QUALITY ONE-PIECE CARBIDE-TIPPED ROUTER BITS IN THE MOST USEFUL SIZES AND SHAPES.

1/4" SHANK SET \$64.95 PPD.

1/2" SHANK SET \$69.95 PPD.

AND WHAT'S MORE WE INCLUDE AN EXTRA BEARING SO THE ROUND-OVER MAY BE USED FOR BEADING.



SHAPER CUTTERS
1/2" BORE \$20.00



INDUSTRIAL SHAPER CUTTERS
3/4" BORE WITH 1/2" BUSHING
\$30.00



6-PIECE CABINET SETS
3/4" BORE WITH
1/2" BUSHING \$149.00



3 WING PANEL RAISER
1 1/4" BORE WITH 1" &
3/4" BUSHINGS \$48.00

ORDER BY PHONE WITH VISA/MC OR SEND MO, CHECK, VISA/MC NUMBER, EXP. DATE, PHONE NUMBER. CATALOG \$1 — FEATURING OVER 200 CARBIDE TIPPED ROUTER BITS AND SHAPER CUTTERS.



Satisfaction Guaranteed
or your Money Back.
Call 206-236-0272 or write:



CASCADE PRECISION TOOL CO. INC.
P.O. BOX 848, MERCER ISLAND, WA 98040.

THE DOOR SHOP™

The original Ogee DOOR SHOP™ as featured in WOOD MAGAZINE (MAY/JUNE 85) is complete with style & rail, slot & panel raising bits for the 1/4" chuck router. Bits are carbide tipped & BB. & will make 3/4"-2-1/4" thick raised panel doors, \$89.50 ppd.

TO ORDER
CALL 800-441-0101

IN NY 212-947-4496.

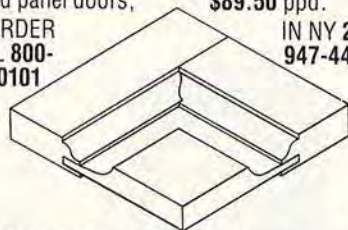

ZAC PRODUCTS INC. 533 West 34 St.
NYC, NY 10001

WOOD PARTS

WOODWORKS

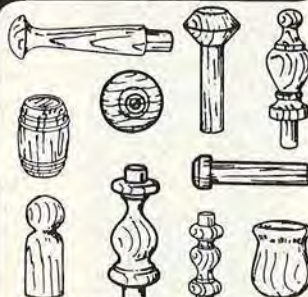

Catalog \$1.00 First Class
Free Third Class
WOODWORKS

4013-A Clay Ave. • Ft. Worth, TX 76117

THE FINE TOOL JOURNAL — Published 10 times per year, this publication will keep you up to date with the many aspects of the world of antique and obsolete hand tools. Tools are offered for sale, books on tools are reviewed and sold, auctions are reviewed, articles on identification, values, and history. Send for sample copy. IRON HORSE ANTIQUES, INC. \$1.50. *Circle No. 800.*

FREE WOODWORKING TOOL CATALOG — This 1984 catalog features hand tools, power tools, and shop machinery: professional quality tools — great selection and value priced. Great names, too: Marples, Sorby, Makita, Rockwell, Hegner, Freud, Primus, Porter-Cable, Milwaukee, Watco, and more. W.S. JENKS & SON. Free. *Circle No. 930.*

FREE LITERATURE — New brochure showing all moisture meters and accessories for moisture meters such as interchangeable electrodes and probes and cables for in-kiln moisture monitoring. Complete line of moisture meters include: Pocket-size Mini-Ligno with LED readout 6%-20%, Mini Ligno E 6%-36%, analog display meters 4%-30%, 60% and a digital moisture meter with built-in compensation for different wood temperatures. LIGNO-MAT USA, LTD. Free. *Circle No. 1130.*

WOODWORKING PLANS — Catalog of full-size plans printed on heavy paper for toys, gifts, novelties, action windmills, shelves, birdhouses, garden furniture, Dutch windmill, lawn ornaments, old-fashioned lawn swing, jigsaw projects for children, and more. MASTERCRAFT PLANS WEST. \$1.00. *Circle No. 1216.*

WOODWORKING BOOKS AT DISCOUNT PRICES — Most complete listing of books for woodworkers. Each book is discounted from 10 to 25% off the cover price. There is absolutely no shipping and handling charge. Woodworking, carving, turning, project books by authors such as Krenov, Frid, Spielman, Nish, Tangerman, and Hoadley are listed along with many hard-to-find titles. MANNY'S WOODWORKER'S PLACE. \$2.00. *Circle No. 1217.*

TIPS ON WOOD FINISHING — A comprehensive, 22-page booklet includes numerous tips that save time and trouble for do-it-yourselfers. Information ranges from how to apply a preservative stain to a house exterior to restoring the finish of a priceless antique. Also included is a chart showing full range of both interior and exterior colors available. The name of your nearest dealer is provided. MINWAX CO., INC. Free. *Circle No. 1240.*

CLAMP AND STRAPPING KIT — Brochure features a simple operated clamping device for assembling cabinets, speakers, picture frames, door parts assembly, and cabinet framing needs. You get professional strapping results with MITY-TITE Adjustable Tension Tool. All parts are reusable. Great for assembling and holding of production parts while working on or glueing. Send for brochure and prices. MITY-TITE SYSTEMS. \$1.00. *Circle No. 1255.*

WOODEN SHIP MODELS — Discover the world's hobby — building fine-quality, historic wooden ship models. Described are true-to-life scale replicas, lifelike in every detail. A 116-page color catalog introduces you to this fascinating hobby. MODEL EXPO, INC. \$3.00 (Refunded with first order). *Circle No. 1256.*

WOOD CARVING — You can obtain information on learning woodcarving by sending for our literature. The offer includes sample copy of *The Mallet Magazine* and two lesson sheets on carving. NATIONAL CARVERS MUSEUM. \$1.00. *Circle No. 1300.*

CLOCK COMPONENTS — We feature battery, pendulum, and chime quartz movements of all types: Urgos, Hermlle, Grandmother, Grandfather cable drive and chain drive, keywind movements of all types. 400-day clocks, music box movements, flat and benzol type dials — plus a vast assortment of weather instruments. Hundreds of clock items. Very competitive. 75-page catalog. NEWPORT ENTERPRISES. Free. *Circle No. 1320.*

WOOD WORKERS—CARVERS SUPPLIES — Catalog on hard to find items. E-Z pneumatic drum sander, Freedom tools and accessories, Detail Master woodburning unit, abrasive cartridge rolls, books, patterns, much more. NORTH WEST CARVING SUPPLIES. \$2.00. (Refundable). *Circle No. 1360.*

PERSONAL BRANDING IRON — Brochures de-

Our catalog doesn't just sell you things. It teaches you things.

The Garrett Wade Catalog is a new, 212-page collection of woodworking hand tools, machinery, finishing supplies and accessories that are simply the finest available. Anywhere.

And besides offering quality tools from around the world, we also give you a lot of quality advice. On woodworking techniques. On picking the proper tool for a particular job. On finishing, sharpening, clamping and more.

The catalog is filled with superb photography, honest specifications and reliable descriptions. It's neatly divided into seventeen sections, including a section on our Swiss INJECTA INCA power tools. And throughout the year, our catalog owners will receive several handy supplements—*free of charge.*

Just send in the coupon below with \$3.00, and we'll send out your copy of the 1985 Garrett Wade Catalog. It just may prove to be the most useful tool you own.

Garrett Wade Co., Inc., Dept. 268
161 Avenue of the Americas
New York, N.Y. 10013
Gentlemen:

Send your complete 212-page catalog of woodworking tools, machinery, and accessories. Enclosed is \$3.

I would like *only* the following sections of the catalog, for 50¢ each:

INJECTA INCA Carving Finishing

Enclosed is \$ _____

Name _____

Address _____

City _____

State _____

Zip _____



**NEW
POWER
FEED**

DRUM SANDER



At last! A complete power-feed Drum Sander at an affordable price! Comes ready to use including hood, stand and motor! Choose from 12" and 26" models.

FINISH SANDING... THICKNESS SANDING

Use this high-tolerance machine for light dimensioning as well as the finest finish work. Now you can add new beauty to each woodworking project... save hours of tedious hand sanding! In a matter of seconds, the Model 1200 can produce a satin-smooth finish impossible to duplicate with hand methods or hand-held power sanders... no more low spots, waves or cross-grain marks!

IMPROVES RESULTS!

Send for complete facts! See how the Model 1200 can dimension and finish-sand cabinet pieces, resawn stock paneling, grandfather clocks, toys, tabletops, knees, burls, crotches, and much, much more! You'll soon find it's one of the most valuable tools in your shop!

Call Toll-Free 1(800) 824-7888 Oper. 642

**SANDER
FACTS**

YES! Please rush my **FREE INFORMATION KIT** and details on your 30-Day Free Trial Guarantee. Woodmaster Tools, Dept. RW9 2908 Oak, Kansas City, MO 64108

NAME _____

ADDRESS _____

CITY _____

STATE _____

ZIP _____

**Free
30 Day Trial!**

Send for complete facts on how you can try the Woodmaster Power-Feed Drum Sander in your own shop for 30 days completely without risk!

scribes line of branding irons that makes it easy to put your name on your work. Made especially for branding wood, they are available with 1, 2, or 3 lines of copy in either 1/8- or 1/4-in. letters. Makes a clean, sharp mark that shows pride in workmanship. Also included is information on handscrew clamp hardware that allows you to make your own clamps at approximately 50% savings. NOVA TOOL CO. \$1.00. *Circle No. 1380.*

64-PAGE PROBLEM SOLVER CATALOG — Over 700 woodworking items. Authentically reproduced furniture pulls, knobs, locks, casters, table slides, hinges, supports, latches, catches, bed hardware, veneer, chair cane, books, and much more. Satisfaction guaranteed. PAXTON HARDWEARE LTD. \$2.50. *Circle No. 1480.*

QUARTZ CLOCK MOVEMENTS — Deal directly with the nation's largest independent distributor of quartz clock movements. Thousands of ultra-thin, pendulum, and chime movements in stock at all times. Our 36-page catalog features a large selection of hands, dials, numerals, weather instruments, as well as many other clock making supplies. Most orders shipped within 48 hours. PRECISION MOVEMENTS. Free. *Circle No. 1555.*

SWISS WOODWORKING BENCHES — Woodworkers. Qualitech Workbenches offers you a free brochure and price list for high quality woodworking benches imported from Switzerland. Affordable prices and a 30-day money-back guarantee. QUALITECH WORKBENCHES. Free. *Circle No. 1580.*

RODMAN HAS TRUE GRIP CLAMPS — These unique clamps are a basic woodworking necessity. CLAMP 'N TOOL GUIDE is the first bar clamp that may be used as a straight edge. The BACK TO BACK BENCH CLAMP features low profile clamping jaws and a super wide capacity. TRUE GRIP is a new clamping system invented and manufactured in the U.S.A. Send for catalog sheet. RODMAN TOOLS. Free. *Circle No. 1655.*

MAKE WOOD SIGNS — SignCraft is the bimonthly magazine for the signmaker. Regular features include color photos, articles and tips about routed, carved, sandblasted and painted wood signs, plus

many other types of hand produced signs. Have you ever considered putting your woodworking skills to work in the lucrative field of signmaking? Send for subscription information. SIGNCRAFT MAGAZINE. Free. *Circle No. 1723.*

SLEEVELESS DRUM SANDERS — Economical—simply cut sandpaper from standard size sheets. Unique way of holding sandpaper to drum—a twist of the key tightens. Sponge rubber backing insures long wear of sandpaper. Sanders can be used on drill press, small motor, lathe, combo-tools, radial saw, hand drill, and other revolving devices. Send for brochure. SINGLEY SPECIALTY CO., INC. Free. *Circle No. 1735.*

SYSTEMS IN JOINERY — New 25-page illustrated catalog featuring many uses of the joint-matic and introduction of other high quality machines, fixtures, and cutting tools that make many of the more difficult tasks in woodworking easier. STRONG TOOL DESIGN. \$2.00. *Circle No. 1745.*

CUPOLA AND BRIDGE STUDY PLAN BOOK — Consists of designs for 22-ft. bridges, 8 covered bridges, 36 cupolas, and some history of each. Complete plans available for each design. SUN DESIGNS. \$7.95. *Circle No. 1750.*

FINE WOODWORKING VIDEO TAPES — Now you can learn woodworking from top professionals in your own home, at your own pace. Our brochure describes the five tapes in the series: *Dovetailing a Draw, Bowl Turning, Wood Finishing, Carving a Ball-and-Claw Foot, and Radial-Arm-Saw Joinery* — all from the publishers of Fine Woodworking Magazine. TAUNTON PRESS. 50¢. *Circle No. 1800.*

TOYMAKERS SUPPLIES — Catalog of over 100 full-size wooden toy patterns — classic to contemporary designs from Packard Le Baron to Streamlined train and moon machine. Easy to follow, fully illustrated patterns which appeal to all ages. Hardwood wheels, shaker pegs, axles, etc., in stock. Accessory kits of pattern and turnings available. TOY DESIGNS. \$1.50. *Circle No. 1860.*

CLAMPS FOR ALL YOUR WOODWORKING

NEEDS — Information and prices on our new line of lightweight clamps especially designed for the small shop where work and storage areas are limited. Many replace those long, heavy lengths of pipe we've all wrestled for so long. Also have attachments for the Shopsmith Mark V and Multi Tool Imports. Prices include UPS delivery with shipment often the same day. UNIVERSAL CLAMP CO. Free. *Circle No. 1930.*

IF YOU ARE INTERESTED IN RESTORING ANTIQUES — this 112-page catalog packed with unusual, hard-to-find items is just for you. Included are hundreds of essential items for antique restoration including top quality brass reproduction hardware, oil lamps and accessories, numerous wood component repair parts and kits, caning and basketry supplies, everything needed for wood refinishing, related tools, books, and a complete line of upholstery equipment and supplies. All at wholesale prices. Send for this informative catalog. VAN DYKE SUPPLY CO. Free. *Circle No. 1970.*

WOODCARVING TOOLS — Whittlers and carvers — Warren Tool Co. offers a catalog for you full of whittling and carving hand/power tools, books, stones, wood, and supplies. Since 1927, the finest in woodcarvers tools. WARREN TOOL CO., INC. 60¢. *Circle No. 2020.*

THE JAPAN WOODWORKER'S 1984 CATALOG — is loaded with the best tools you can get your hands on. In our catalog you will find a complete selection of Japanese tools for the woodcarver, carpenter, and cabinet maker. Send for catalog plus supplements for next two years. WOODLINE-THE JAPAN WOODWORKER. \$1.50. *Circle No. 2075.*

POWER-FEED DRUM SANDER — Use the Woodmaster Model 1200 to dimension and finish-sand cabinet pieces, resaw stock, paneling, grandfather clocks, toys, table tops, knees, burls, crotch-ches, and much more. This heavy-duty 12 in. sander comes complete with motor and stand. 30 day free trial...easy terms. Send for information kit. WOODMASTER TOOLS. Free. *Circle No. 2080.*

HIGH PRECISION SCROLL SAW — The sturdy, new Woodmaster Model 1600 gives you all the features found in more expensive machines including big, 16-in. throat capacity, 2-in. cutting depth, a generous, oversized worktable, ball-bearing drive... and much more! Send for complete facts. See how you can use the Woodmaster Model 1600 in your own shop for one full month completely without risk. Send for information kit. WOODMASTER TOOLS, INC. Free. *Circle No. 2081.*

GIANT 24½-IN., 3-SPEED BAND SAW — Big 24½-in. throat easily handles large scrollwork, complex curves, 4x8 sheets. 9-in. vertical cut makes it easy to resaw valuable hardwoods. Ball bearing construction, all-steel welded frame to eliminate deflection. Can be ordered complete with motor, stand, dust collector, rip fence, scroll saw table. Full instructions. Send for complete facts on how you can try this versatile saw without risk. Easy terms. WOODMASTER TOOLS, INC. Free. *Circle No. 2082.*

QUALITY AMERICAN-MADE WOOD TURNINGS — such as shaker pegs, spindles, toy wheels, toy parts, craft items, and dowel rods in birch, oak, walnut, and cherry. Send for complete 32-page catalog. WOODWORKS. \$1.00. *Circle No. 2130.*

NEW AND ORIGINAL DESIGNS — We've been designing projects for magazines and other clients for years, so, we decided it was about time to sell our own line of plans. Send for our folder of woodworking projects designed by David Ashe for THE WORKSHOP BLUEPRINT CO. 75¢. *Circle No. 2150.*

CARBIDE ROUTER AND SHAPER BITS — Our industrial carbide router bits will make you and your work achieve your goals, make things happen, and avoid problems. Zac router bits will expand your possibilities and options while giving the precise details you need. With your router and our tooling your shop becomes a system that you and your family will be proud of. Feel the satisfaction of improving your shops while you and others will know you bought the best. We consistently deliver high-quality router bits shaper cutters. Our 32-page catalog will improve your knowledge and skills. Send for it today. ZAC PRODUCTS, INC. \$2.50. *Circle No. 2195.*

Information

WORTH WRITING FOR

Better Homes and Gardens®
WOOD MAGAZINE, December,
1985/86 Dept. NDWO5
P.O. BOX 2051
CLINTON, IA 52732

TO ENSURE PROMPT HANDLING OF YOUR ORDER FOLLOW THESE INSTRUCTIONS:

- Circle your choice
- Enclose cash, check, money order for cost of booklets plus \$2.00 service charge (no stamps/foreign)
- Send coupon and remittance to address above
- ALLOW 4-6 WEEKS FOR DELIVERY
- Coupon expires December 15, 1986

WOOD SUBSCRIPTION

1. A 1 year WOOD subscription (6 issues) for \$15.00 — a \$6.00 savings off newstand rate. Allow 6-8 weeks for first issue. Add \$6.00 outside U.S. Be sure to include payment with total below.

FREE LITERATURE

Circle numbers below corresponding to items in this issue. Please include \$2.00 for handling charge

273.	930.	1320.	1655.	1930.	2081.
402.	1130.	1555.	1723.	1970.	2082.
660.	1240.	1580.	1735.	2080.	

PRICED LITERATURE

Numbers below refer to items on which there is a charge. Please include proper remittance.

2...\$1.00	146...\$2.00	420...\$2.00	710...\$1.00	1217...\$2.00	1745...\$2.00	2150...75¢
12...\$2.00	150...\$4.50	495...\$1.00	730...\$1.00	1255...\$1.00	1750...\$7.95	2195...\$2.50
15...\$2.00	230...\$1.00	560...\$5.00	750...\$2.00	1256...\$3.00	1800...50¢	
30...\$1.00	245...\$1.00	570...\$1.00	770...\$1.00	1300...\$1.00	1860...\$1.50	
45...\$1.00	270...\$1.00	585...\$2.00	780...\$1.00	1360...\$2.00	2020...60¢	
50...\$2.00	274...\$2.00	590...\$4.65	800...\$1.50	1380...\$1.00	2075...\$1.50	
130...\$2.00	315...50¢	650...\$1.00	1216...\$1.00	1480...\$2.50	2130...\$1.00	

Name (please print) _____
 Address _____
 City _____
 State _____ Zip Code _____

I AM ENCLOSING:
 \$ _____ for priced items
 \$ 2.00 for handling
 \$ _____ total remittance



ONLY
\$299.95!

90 DAY GUARANTEE
If you are not satisfied for any reason, just send it back for a prompt, full refund. If the product is defective, we even pay return shipping.

My **NEW SCROLL SAW** has a hinged arm to make repositioning your work easy –

cuts wood up to 2" thick with a 20" radius, and has a built-in air pump to blow away dust and chips so you can always see what you're doing!

CALL TOLL FREE 1-800-243-1037 TO ORDER IT TODAY! In Connecticut, 797-0772

To separate the head from the blade, just loosen the blade tension knob and lift the hinged arm. Then position the workpiece over the blade and return the arm to the working mode. Blade changing is just as simple. The blade tension knob maintains constant, uniform tension. A quality machine at a very reasonable price.

- 10" x 10" cast aluminum table tilts 20° left or right
- Cuts metal or wood
- Cast aluminum frame
- Throat capacity, 20"
- 110V-60 cycles
- Speed 1100 spm
- Weight 35 lbs.



The Fine Tool Shops, Inc.
Dept. WM35
20 Backus Ave., Box 1262
Danbury, CT 06810

Send me _____ (qty.) SCROLL SAW(S) at \$299.95 plus \$7.50 shipping/handling (total \$307.45). This order automatically makes me a member of your FTS Club. I will receive an instant credit of \$8.75, and will receive 5% discount on all future purchases as long as I keep my membership active.

Enclosed is check money order for \$_____ Charge my VISA AmExpress MasterCard

Account # _____ Exp. Date _____

Ship to _____

Address _____

City _____ State _____ Zip _____

Send your 76-page full color catalog of fine hand and power tools FREE with my order.

Do you have the wright stuff? Roy does.

Watch him on

The Woodwright's Shop with Roy Underhill

Check local listings for day and time.

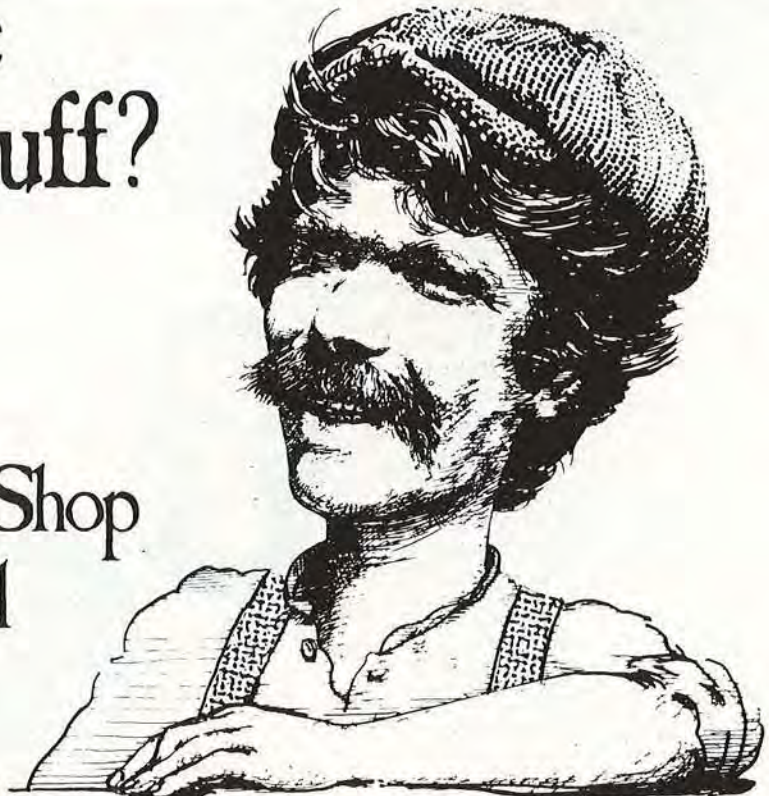

A production of The University of North Carolina Center for Public Television

WHY GOOD WOOD COSTS SO MUCH



You could really save money if you bought hardwood directly from the logger—black cherry at \$350 a thousand board feet, hard maple for \$305 a thousand, or the same amount of red oak for \$500! That's what Wisconsin mills paid, on the average, for prime sawlogs early this year, says a state forest industry report. At your lumberyard you'd pay eight to ten times those board foot prices.

Why the big cost difference? Most wood you purchase at retail happens to be kiln-dried and stable, ready to work. Getting wood to that stage costs a lot of money. Rough-sawing the logs, air-drying then kiln-drying them, plus the loss of 25 percent to checks and splits, doubles their initial price. Interest charges for the year of seasoning, storage, handling, and shipping doubles the amount again. Now add the charges for broker's fee, surfacing two sides, and the 50 percent markup the retailer has to have to cover overhead and profit, and you can see why there's such a big spread between wood prices off the stump and at the lumberyard.



FACTS, FACES & FABLES OF INTEREST TO HOME WOODWORKERS

WHAT WAS A DOG TO DO?

Prior to the 1900's, dogs had little attraction to fireplugs, since the plugs, then made of wood, were at the bottom of a hole in the ground.

Back then, notes the American Water Works Association, wooden waterlines were buried in the ground, just as cast iron lines are today. But instead of above-ground hydrants, holes were dug down to the lines, which were drilled and fitted with wooden plugs. In case of fire, the plug was pulled and water filled the excavation. Firemen pumped the water from the hole; the fire out, the plug was replaced.

What kinds of wood could hold water underground? According to the Association, coopers staved up redwood for this purpose on the West Coast where it was plentiful. In other parts of the country, 8" to 10"-diameter hickory, elm, or other hardwood trees were bored for a 1½" hole, then buried. They leaked a little, but worked.

AROUND THE NATION

Excellence in Woodworking. Nov. 2. Ramada Inn, Columbia, Mo. Exhibit and sale of woodworking projects; displays of equipment and supplies. Sponsored by the Midwest Woodworkers Association.

Fair of Traditional Crafts. Nov. 2-3. Old Sturbridge Village, Sturbridge, Mass. Exhibit and sale of pottery, metal, wood, and textile items.

Midwestern Wood Carvers Show. Nov. 2-3. Belle-Clair Exposition Hall, Belleville, Ill. 15th annual show. Exhibits, displays, demonstration of tools. Sponsored by the Midwestern Wood Carvers Club.

Woodcarvers Festival. Nov. 2-3. Mountain Side Recreation Center, Wallingford, Conn. First annual New England Woodcarvers Competition.

Northwest Woodcarving Show/Sale. Nov. 9-10. Western Washington Fairgrounds Expo Hall, Puyallup, Wash. 5th annual.

Woodworking World Shows. Nov. 15-17. Charlotte Civic Center, Charlotte, N.C. Dec. 6-8. Oakland Convention Center, Oakland, Cal. Tools, supplies, demonstrations, and seminars for woodworkers.

North American Songbird Carving Championship. Nov. 15-17. York Fair Grounds, York, Pa. Cash awards. Sponsored by York Chapter Ducks Unlimited.

Artistry in Wood. Nov. 30-Dec. 1. Marymount College, Arlington, Va. 11th annual woodcarving show sponsored by the Northern Virginia Carvers.



Walnut burl, used on the dashboards of Jaguar cars, actually comes from California. The classy dash, made in the firm's woodworking shop, takes six hours of handcrafting to produce, far less than its travel time.

WAS THERE REALLY A MR. BLACK AND A MR. DECKER?

Yes, woodworkers, there was. The giant, international producer of power tools we know as Black & Decker was founded in 1910 by S. Duncan Black, age 27, and Alonzo G. Decker, 26. With \$1,200 they saved and raised by selling stock, this inventive pair of machinists began the Black & Decker Manufacturing Company in Baltimore.

The company built machines to cap milk bottles, address letters, dip candy, pick cotton, and add numbers. In 1912, Mr. Black and Mr. Decker adopted the now-familiar hex trademark. A year later they were able to pay a cash dividend.

By 1917 the young pair had



S. Duncan Black



Alonzo G. Decker

received a U.S. patent for their portable electric drill with a pistol grip and a trigger switch. This ½" drill, and a small electric air compressor, were the first products to carry the Black & Decker label. Success came immediately, and by 1919 the now-thriving company had built a new plant and passed the \$1 million sales level.

Celebrating its 75th birthday this year, Black and Decker has operations around the world, and an expanding new housewares line. A son of one of the founders, Alonzo G. Decker, Jr., represents the original founders as the firm's Honorary Chairman. ■

Ryobi and Freud.

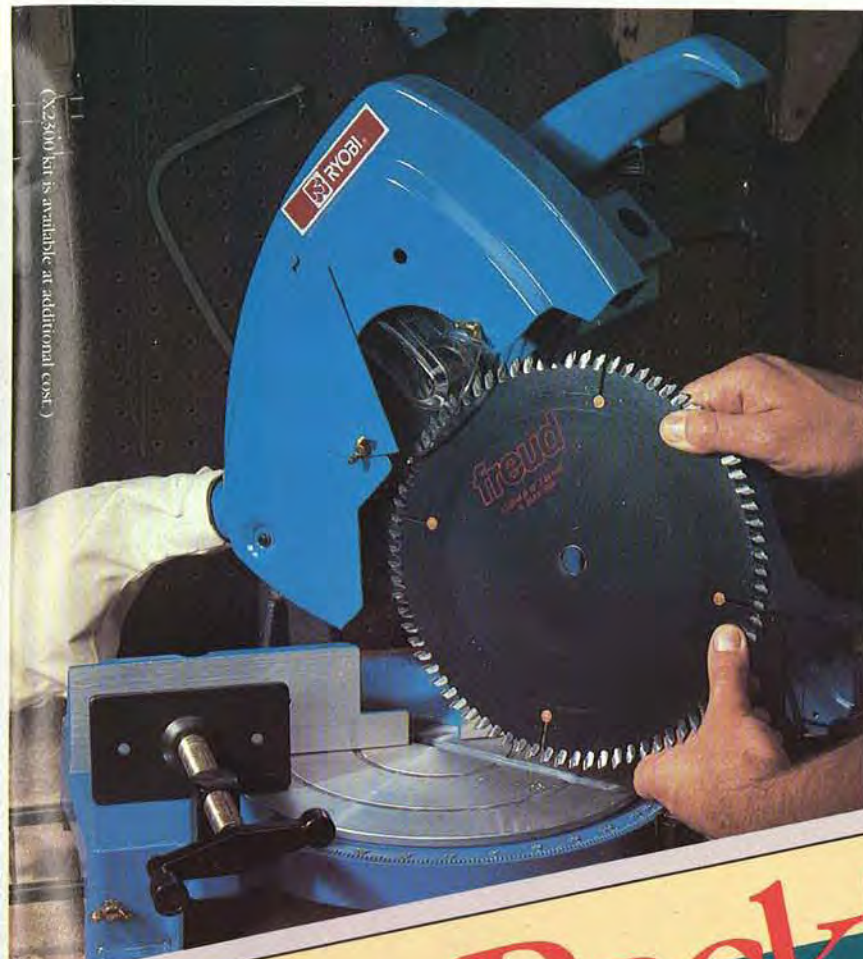

Super saw...
Super blade...
Super deal!!

It's Back!

While quantities last, buy a Ryobi 10" Miter Saw and Freud 80-tooth carbide tipped saw blade at participating dealers for only \$229.95. (suggested list price \$410.88).

Ryobi Miter Saw Model TS-251U.

- Die-cast aluminum turntable moves with saw head
- Automatic electric braking system stops blades in seconds
- Positive click stops at 0, 22-1/2 and 45 degrees both left and right
- Degree markings cast into the base for permanency

The best in power tools and saw blades is yours once again in one super offer.

- Lightweight design made even better by an exclusive carrying handle
- 12.5 amp heavy duty motor
- Superior accuracy for trims, baseboards, mitering... even 2 x 4's

Freud Blade LU85M010

- Features Freud's state-of-the-art design and engineering
- Carbide tipped for fast cutting and long life
- 80 teeth for smooth precision cuts
- Self lubricating - body is coated with anti-grip material

Call 1-800-621-1776 for the participating dealer nearest you.

In Illinois call 1-800-572-6724.



Ryobi America Corporation
1158 Tower Lane
Bensenville, IL 60160

- Die-cast a
- Automatic
- Positive cli
- Degree ma
- Lightweight
- 12.5 amp he
- Superior acc

Get a FREE Ryobi Router

and save \$213⁰⁰ when you buy **Freud's NEW Industrial Carbide Router Bit Set.**

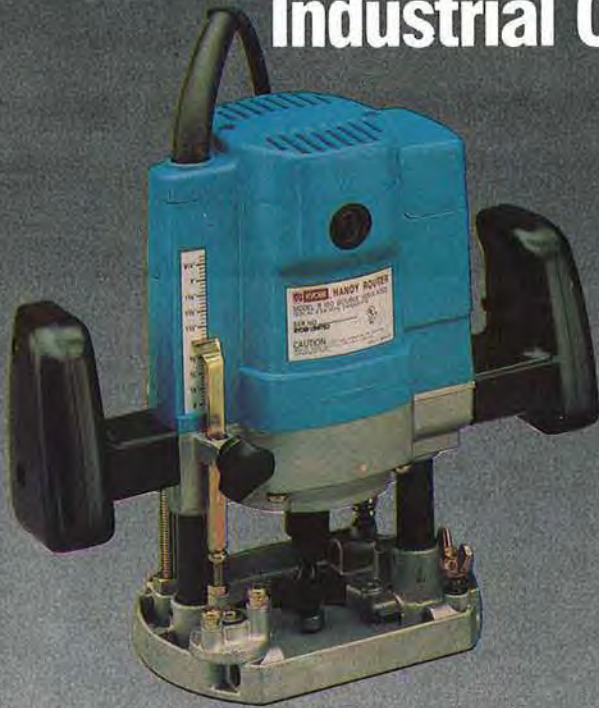

**Router Reg. \$162⁰⁰, Router Bit Set \$300⁰⁰ Value, Total Value \$462⁰⁰
Yours for only \$249⁰⁰**

The Router Bit Set

Freud engineers have designed an industrial quality carbide router bit set at an affordable price. These precision tools are of the finest quality, and manufactured using only carbide or carbide-tipped bits. Carbide will last up to 50 times longer than steel bits before sharpening is required.

These bits exceed all requirements when cutting hard or soft woods, plastics or composition materials. In manufacturing, specific carbide grades are used to insure durable edges, and all bits are ground twice. This provides an extremely sharp mirror edge that cuts like no other on the market.

The Router

Ryobi (Model R-151) 1 Horsepower Plunge Router with new trigger switch on handle. Plunges 0 to 2 inches. It's light weight and compactness makes routing easy to handle. The plunge depth is set quickly by thumb action. The stop block can be adjusted for 3 different cutting levels. 24,000 RPM's. Double insulated. 1/4" collet capacity. Comes complete with router bit adapter, template guide, straight guide and spanners.

90-100 Set consists of:

Item	Description	Cutting Length	Cutting Dia.	Radius (Bevel)	Depth of Cut	List Price
04-106	Solid Carbide Straight 2 Flute	3/4	1/4			11.05
04-140	Straight 2 Flute	3/4	3/4			15.60
16-100	Mortising	3/4	1/2			12.73
18-104	Solid Carbide Round Nose	1/2	1/4	1/8		17.64
20-104	"V" Grooving		1/2		1/2	21.15
22-104	Dovetail		1/2	(14°)	1/2	16.33
26-100	Panel Pilot	3/4	1/4			9.43
30-106	Cove			1/2	3/8	33.64
32-100	Rabbet	1/2			3/8	27.62
34-114	Rounding Over			3/8		30.03
38-100	Roman Ogee			5/32		32.90
40-106	Chamfer	1		(45°)		26.42
42-106	Flush Trim	1/2	1/2			15.62
64-100	Solid Carbide Flush Trim	3/8				7.64
66-100	Solid Carbide Bevel Trim	1/4		(7°)		8.30

Box jointed wooden case, value \$28.00

Call Us Toll Free!

FOR THE NAME OF YOUR LOCAL DISTRIBUTOR:

- In California
Call Toll Free:
1-800-824-0141
- If You Live
In This Area:
1-800-824-8045
- If Your Live
In This Area
Call Toll Free
(Outside NC)
1-800-334-4107

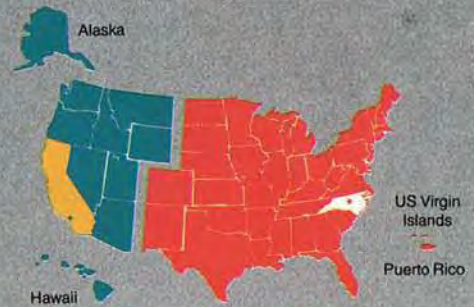

freud

218 Feld Ave., High Point, NC 27264
(919) 434-3171

1570 Corporate Dr., Suite G
Costa Mesa, Cal. 92626
(714) 751-8866

Offer valid only in USA through Dec., 31, 1985